

**KLS martin**  
GROUP



Allgemeine Chirurgie  
General Surgery  
Cirugía general  
Chirurgie générale  
Chirurgia generale

General

# Chirurgische Instrumente



Seit 1896



Surgical Innovation is our Passion



# Chirurgische Innovation ist unsere Leidenschaft

Wie kommt man dazu, über 12.000 chirurgische Instrumente zu entwickeln, zu fertigen und zu vermarkten? Produkte, die sich durch klare Alleinstellungsmerkmale auszeichnen. Es ist die Leidenschaft, neue Wege zu finden, die Menschen helfen und der Gesundheit dienen.



## **EN** Surgical Innovation is our passion

What is the secret behind the development, manufacture and distribution of over 12,000 exclusive surgical instruments, products whose distinguishing characteristics truly set them apart from all the others? The answer is passion, the overwhelming desire to discover new ways of serving humankind in its search for ultimate health.

## **ES** La innovación quirúrgica es nuestra pasión

¿Cómo es posible concebir, producir y comercializar más de 12.000 instrumentos quirúrgicos? Estamos hablando de productos que se caracterizan por unas propiedades exclusivas, claramente definidas. La clave está en que nos motiva la pasión por encontrar nuevos caminos para ayudar a las personas y fomentar la salud.

## **FR** Notre passion est l'innovation chirurgicale

Comment est-il possible de développer, fabriquer et commercialiser plus de 12.000 instruments chirurgicaux ? Des produits dont les caractéristiques distinctives sont leur position unique sur le marché. Et bien, ceci est en fait dû à la passion de vouloir trouver de nouvelles méthodes afin de venir en aide aux personnes et de servir la santé.

## **IT** L'innovazione nella chirurgia è la nostra passione

Che cosa ci spinge a progettare, produrre e distribuire più di 12.000 strumenti chirurgici dalle caratteristiche uniche? Sono la nostra passione e il desiderio di aiutare il prossimo e cercare nuove vie per migliorare la salute.



Am Anfang stand die Vision, aus kleinen Firmen eine international agierende Unternehmensgruppe zu bilden. Seit 1896 widmen wir uns der Chirurgie. Heute beschäftigt die KLS Martin Group über 1.400 Mitarbeiter und ist einer der weltweit führenden Konzerne für Entwicklung, Produktion und Vertrieb medizintechnischer Produkte, die in enger Zusammenarbeit mit denjenigen entwickelt werden, die sie letztlich einsetzen: den Chirurgen.

EN

#### In the beginning there was a vision

Our vision was to create an internationally operating group of companies from a handful of smaller businesses. Since 1896 we have been dedicated to surgery. Today, the KLS Martin Group has a staff of over 1,400 and is one of the leading globally acting enterprises for the development, manufacture and distribution of medical devices. We work hand in hand with those holding the scalpel: the surgeons.

ES

#### Todo comienzo parte de una visión

Al principio la visión consistía en conformar, a partir de pequeñas empresas, un grupo empresarial con intervención a escala mundial. Desde 1896 nos hemos dedicado a la cirugía. Hoy en día, el KLS Martin Group da trabajo a más de 1.400 personas y se encuentra a nivel mundial entre los consorcios líderes dedicados al desarrollo, producción y comercialización de productos medicotécnicos, diseñados en estrecha colaboración con aquel grupo de personas que finalmente los emplean: los cirujanos.

FR

#### Tout commença par une vision

Au début, en naquit la vision de pouvoir former un groupe d'entreprises à activités internationales à partir de petites entreprises. Depuis 1896, nous nous consacrons à la chirurgie. Le groupe KLS Martin Group occupe actuellement plus de 1.400 employés et il est l'un des groupes leaders sur le marché mondial dans le secteur du développement, de la production et de la commercialisation de produits médico-techniques, ces produits ayant été développés en étroite collaboration avec ceux les utilisant, c'est-à-dire les chirurgiens.

IT

#### All'inizio c'era una visione

All'inizio c'era una visione: fondere piccole ditte per creare un gruppo aziendale operante a livello internazionale. Dal 1896 ci dedichiamo alla chirurgia. Oggi il KLS Martin Group ha più di 1.400 dipendenti ed è una delle imprese leader al mondo nella progettazione, produzione e distribuzione di prodotti medicali creati in stretta collaborazione con gli utenti finali: i chirurghi.

Am Anfang  
stand eine Vision







## Qualitätssicherung ohne Kompromisse

Unsere Produkte erfüllen den Anspruch anwendungsbezogener Funktionalität, intelligenter Handhabung und hoher Qualität. Und wenn es um die Erfüllung dieses Anspruchs geht, machen wir keine Kompromisse. Um dies zu gewährleisten, unterhält KLS Martin ein eigenes hochmodernes Labor sowie ein Technikum, in denen die Qualität unserer Erzeugnisse – auch unter extremen Bedingungen – auf „Herz und Nieren“ getestet und dokumentiert werden.

EN

### Quality assurance uncompromising

Our products are designed to consistently meet high demands for application-oriented functionality, intelligent operation and top quality. And we are not prepared to compromise when it comes to meeting the justified expectations of our customers, present and future – your standards become ours. KLS Martin runs their own ultramodern laboratories and a pilot plant, where our products are stress-tested under extreme conditions – every step is documented before release.

ES

### Un seguro de calidad sin compromisos

Nuestros productos cumplen el requisito de estar dotados de la funcionalidad conforme a su aplicación, su manipulación es inteligente y son de alta calidad. No transigimos a la hora de cumplir con estas condiciones esenciales. Por este motivo, KLS Martin mantiene un laboratorio propio, altamente moderno, así como una escuela técnica, donde se ensaya y documenta la calidad de nuestros productos – inclusive bajo condiciones extremas –, examinándolos “hasta la médula”.

FR

### Une assurance qualité sans compromis

Nos produits répondent aux exigences requises par une fonctionnalité relative à l'application, un maniement intelligent et une qualité élevée. Et nous n'acceptons aucun compromis lorsqu'il s'agit de répondre à ces exigences. KLS Martin possède à ce but son propre laboratoire ultramoderne et son centre technique dans lesquels la qualité de nos produits fabriqués est testée minutieusement – même sous des extrêmes conditions – et les résultats des tests sont documentés.

IT

### Assicurazione della qualità senza compromessi

I nostri prodotti sono stati progettati guardando alle esigenze della prassi applicativa, offrono una manipolazione intelligente e sono di qualità elevata. A tale riguardo non facciamo compromessi. Per garantire questo standard, KLS Martin ha un laboratorio altamente moderno e un centro tecnologico in cui controlla e documenta la qualità di tutti i prodotti, anche in condizioni estreme.

## Wir setzen Standards für die Instrumentenaufbereitung

Wie lassen sich Medizinprodukte vor mechanischer, thermischer oder chemischer Belastung schützen? Was muss man bei der Aufbereitung und Pflege besonders feingliedriger Mikrochirurgie-Instrumente berücksichtigen? Als Mitglied wichtiger Gremien und Arbeitskreise – wie z. B. dem Arbeitskreis Instrumenten-Aufbereitung AKI – gibt KLS Martin Antworten und erarbeitet Lösungen für die optimale Aufbereitung und Pflege von Instrumenten. Von der Auswahl angemessener Reinigungsverfahren bis hin zu Sterilisationsverfahren.

EN

### Standards and best practice: instrument preparation

How best to protect surgical instruments from mechanical, thermal and chemical stresses? What steps are performed to ensure optimal preparation and care of highly delicate microsurgical instruments? KLS Martin, in their capacity as member of important advisory boards and working groups – for example, Working Group Instrument Preparation AKI – is in a position to provide answers and solutions to all inquiries with regard to the optimal preparation and care of instruments, ranging from knowledgeable advice on appropriate cleaning methods through sterilization processes.

ES

### Los estándares y la mejor práctica para la preparación de instrumentos

¿Cómo se pueden proteger los productos médicos contra la actuación de factores mecánicos, térmicos y químicos? ¿Qué es lo que hay que considerar en el momento de preparación y cuidado del instrumental microquirúrgico, constituido fundamentalmente por componentes finos? En función de miembro de asociaciones y comités laborales importantes – como por ejemplo, el Comité Alemán de Trabajo de Preparación de Instrumental AKI – KLS Martin ofrece respuestas y elabora soluciones para el tratamiento y cuidado óptimos del instrumental. Éstas abarcan desde la selección de métodos de limpieza adecuados hasta el procedimiento de esterilización.

FR

### Normes et pratiques idéales pour la préparation des instruments

Comment protéger les produits médicaux contre d'éventuelles contraintes mécaniques, thermiques ou chimiques? Quels points doivent être pris en considération pour le traitement et l'entretien d'instruments micro-chirurgicaux à fine ossature? A titre de membre d'importants organismes et cercles de travail, tels que par exemple l'AKI (Arbeitskreis Instrumenten-Aufbereitung = cercle de travail pour le traitement des instruments), KLS Martin donne des réponses et élabore des solutions pour assurer un traitement et un entretien optimaux des instruments. Depuis la sélection de procédés de nettoyage adéquats jusqu'au procédé de stérilisation.

IT

### Standard e “best practice” per la preparazione degli strumenti

Come si possono proteggere gli strumenti medici da agenti aggressivi di tipo meccanico, termico o chimico? Cosa occorre tenere presente nella preparazione e nella manutenzione di strumenti microchirurgici particolarmente delicati? Quale membro di importanti organi e gruppi di lavoro, come ad esempio AKI, il gruppo tedesco di lavoro per la corretta preparazione degli strumenti, KLS Martin dà risposta e sviluppa soluzioni per la preparazione e la manutenzione ottimali degli strumenti, dalla scelta dei sistemi di pulizia più idonei alle procedure di sterilizzazione.



Wir bieten Ihnen die Möglichkeit, zu Ihrem KLS-Martin-Produkt die passende Gebrauchsanweisung digital anzufordern.

Gebrauchsanweisung anfordern

Anrede

Titel



Lebenslange Garantie  
für MARTIN-Instrumente

... aus Linea

## Lebenslange Garantie – wann immer Sie sie brauchen

Keine Frage, wir sind stets auf der Suche nach der noch besseren Lösung. Das zeichnet den kontinuierlichen Fortschritt in unserem Produktportfolio aus. Gleichwohl sind alle unsere Instrumente qualitativ erstklassig und werden höchsten Ansprüchen gerecht. Und weil wir davon überzeugt sind, gewähren wir auf jedes Instrument bei sach- und fachgerechtem Einsatz eine lebenslange Garantie.

EN

### **Whenever you need it – our lifetime guarantee**

Our determined and ongoing search for the perfect solution is reflected in the dynamic nature of our product portfolio. You simply will not find better instruments on the market. And because we truly believe in the outstanding quality of our products, we offer a lifelong guarantee on each instrument, in connection with appropriate and professional use.

ES

### **Necesite lo que necesite – la garantía es de por vida**

Lo cierto es que siempre estamos en la búsqueda de una solución que sea aún mejor. Esto es lo que determina el progreso continuado de nuestra cartera de producción. Todos nuestros instrumentos son de la misma calidad máxima cumpliendo, por lo tanto cumplan con los requisitos más exigentes. Y como estamos convencidos de ello, garantizamos en todo nuestro instrumental una garantía de por vida, siempre y cuando se utilice como es debido y según las normativas.

FR

### **Si jamais vous en avez besoin – notre garantie à vie**

Nous sommes, sans aucun doute, toujours à la recherche de la solution optimale. Ce fait caractérise le progrès continu dans notre porte-feuille de produits. Tous nos instruments sont à la fois de toute première qualité et conformes à des exigences maximales. Et étant donné ce fait, nous garantissons sur chaque instrument une garantie à vie, à condition que les instruments soient utilisés de manière adéquate et compétente.

IT

### **Ogni qual volta ne avete bisogno – la nostra garanzia a vita**

Essendo alla ricerca di soluzioni sempre migliori, i nostri prodotti vengono costantemente migliorati. Essi sono di qualità eccellente e soddisfano persino le esigenze più elevate. Per questo possiamo accordare una garanzia a vita per ogni strumento impiegato in modo appropriato e corretto.

|                   |   |    |
|-------------------|---|----|
| <b>St</b>         | Edelstahl · stainless steel<br>acero inoxidable · acier inoxydable<br>acciaio inossidabile  | 0  |
| <b>St</b><br>18/8 | martinit-Stahl · martinit steel<br>acero martinit · acier martinit<br>acciaio martinit  | 1  |
| <b>Ti</b>         | Titan · titanium · titanio<br>titane · titanio  | 2  |
| <b>Al</b>         | Aluminium · aluminum · aluminio<br>aluminium · alluminio  | 3  |
| <b>Cr</b>         | Verchromt · chrome-plated<br>cromado · chromé · cromato   | 4  |
| <b>Ag</b>         | Silber · silver · plata<br>argent · argento   | 5  |
| <b>Ce</b>         | Keramik · ceramic · cerámica<br>céramique · ceramica  | 6  |
| <b>Ny</b>         | Nylon · nylon · nailon<br>nylon · nylon   | 7  |
| <b>Sic</b>        | Silikon · silicone<br>silicona · silicone · silicone  | 8  |
| <b>Nit</b>        | Nitinol<br>"Memory Effect"  | 9  |
| <b>SB</b>         | Solid Black<br>Hartstoffbeschichtung<br>(für eine längere Standzeit)<br>Hard-coated surface<br>(for extended life)<br>Recubrimiento con material duro<br>(para una vida útil más larga)<br>Revêtement à surface dure<br>(pour une durée de vie prolongée)<br>Rivestimento in materiale rigido<br>(per una più lunga durata) | 10 |
|                   |   | 11 |
|                   |   | 12 |
|                   |   | 13 |
|                   |   | 14 |
|                   |   | 15 |
|                   |   | 16 |
|                   |   | 17 |
|                   |   | 18 |

cm 0 1 2 3 4 5 6 7 8 9 10 11 12 13 14 15 16 17 18



Verweis · reference · referencia  
référence · rimando



Für Fig. Nr. · for fig. no.  
para fig. no. · pour fig. no.  
per fig. n.



Schneidenlänge · cutting edge length  
longitud de hojas cortantes · longueur  
de lames · lunghezza di lame



Schnittlänge · cutting length  
longitud de corte · longueur de  
coupe · lunghezza di taglio



Anzahl Zähne · number of teeth  
cantidad de dientes · quantité de  
dents · quantità di denti



Anzahl Zinken · number of teeth  
cantidad de dientes · quantité de  
dents · quantità di denti



Spreizweite · spreading width  
extensión · écartement  
apertura



Fadenstärke · thread size  
grosor de hilos · grosseur de fils  
spessore di fili



Kaltlicht · cold light · luz fría  
lumière froide · luce fredda



Warmlicht · warm light · luz cálida  
lumière chaude · luce calda



De Bakey  
Zahnung · serration · dentado  
denture · dentatura



De Bakey baby  
Zahnung · serration · dentado  
denture · dentatura



Cooley  
Zahnung · serration · dentado  
denture · dentatura



Schließkraft · closing pressure  
fuerza de oclusión · pression de  
fermeture · pressione di chiusura



Gesamtlänge · total length  
longitud total · longueur totale  
lunghezza complessiva



Maullänge · jaw length  
longitud de boca · longueur de mors  
lunghezza bocca

Inch  
0

1

2

3

4

5

6

7

## Erläuterungen zum Katalog

Catalog explanations

Explicaciones complementarias al catálogo

Explications sur le catalogue

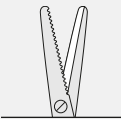
Spiegazioni relative al catalogo

# General



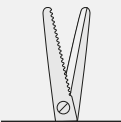
**TC GOLD**

TC-Hartmetall im Arbeitsende  
Tungsten carbide in working end  
Carburo de tungsteno en el extremo de trabajo  
Carbure de tungstène sur extrémité de travail  
Carburo di tungsteno nell'estremità operativa



**SuperCut**

Wellenschliff/Messerschliff  
Serrated edge/knife edge  
Filo ondulado/filo de cuchillo  
Affûtage dentelé / Affûtage couteau  
Taglio ondulato/taglio coltello



**ST**

Wellenschliff/Scherenschliff  
Serrated edge/scissor edge  
Filo ondulado/filo de tijeras  
Affûtage dentelé/affûtage ciseaux  
Taglio ondulato/taglio forbici



**AQUILA**

TC-Hartmetall mit  
Messerschliff/Wellenschliff  
Tungsten carbide with  
knife edge/serrated edge  
Carburo de tungsteno con filo de  
cuchillo/filo ondulado  
Carbure de tungstène avec affûtage  
couteau/affûtage dentelé  
Carburo di tungsteno con  
taglio coltello/taglio ondulato



**TCC BlackLine**

TC-Hartmetall mit Messerschliff/  
Wellenschliff, Solid-Black-beschichtet  
Tungsten carbide with knife edge/  
serrated edge, Solid Black coated  
Carburo de tungsteno con filo de cuchillo/filo  
ondulado, recubrimiento Solid Black  
Carbure de tungstène avec affûtage couteau/  
affûtage dentelé, revêtement Solid Black  
Carburo di tungsteno con taglio coltello/  
taglio ondulato, rivestito in Solid Black



**suture Cut**

Nahtmaterialschere  
Suture material scissors  
Tijeras para material de sutura  
Ciseaux à suture  
Forbici per materiale di sutura

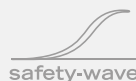
**finoLine**

Schlanke Modelle  
Slim models  
Modelos estilizados  
Modèles minces  
Modelli sottili



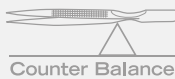
**diamond-coated**

Diamantierte Arbeitsenden  
Diamond-coated working ends  
Extremos de trabajo diamantados  
Extrémités de travail diamantées  
Estremità operative diamantate



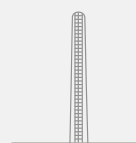
**safety-wave**

Safety-Wave-Sicherheitsschluss  
Safety-Wave safety pivot  
Cierre de seguridad Safety-Wave  
Fermeture sécurisée Safety-Wave  
Arresto di sicurezza Safety-Wave



**Counter Balance**

Counter Balance



**Atrauma**

Atrauma-Zahnung  
Atraumatic serration  
Dentado atraumático  
Dentelure Atrauma  
Dentatura atraumatica



**VD**

Gefäßdilatoren  
Vessel dilators  
Dilatadores vasculares  
Pincès à dilatation de vaisseaux  
Dilatatori vascolari

**STERILE | R**

mit Gamma-Strahlen sterilisierte Produkte  
with gamma radiation sterilized products  
productos esterilizados con rayos gamma  
produits stérilisés avec de rayons gamma  
prodotti sterilizzati con raggi gamma

**TC GOLD**

Instrumente mit Hartmetalleinlagen  
Instruments with tungsten carbide inserts  
Instrumentos con filos de carburo de tungsteno  
Instruments avec plaquettes en carbure  
de tungstène  
Strumenti con taglio in carburo di tungsteno



## Erläuterungen zum Katalog

Catalog explanations

Explicaciones complementarias al catálogo

Explications sur le catalogue

Spiegazioni relative al catalogo

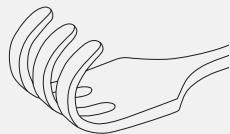
# General



scharf  
sharp  
agudo  
pointu  
acuto



halbscharf  
semi-sharp  
semi-agudo  
semi-pointu  
semi acuto



stumpf  
blunt  
romo  
mousse  
smusso

Blattmaß: Blatttiefe x Blattbreite

Blade dimensions: blade depth x blade width

Dimensiones de la hoja: profundidad hoja x anchura hoja

Dimensions feuille: profondeur feuille x largeur feuille

Misura lama: profondità lama x larghezza lama

Beispiel:

Example:

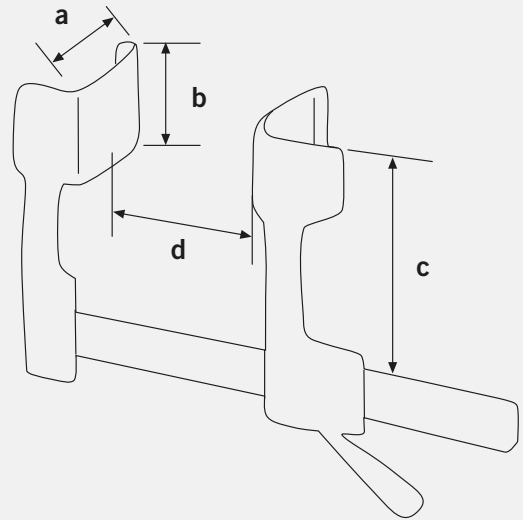
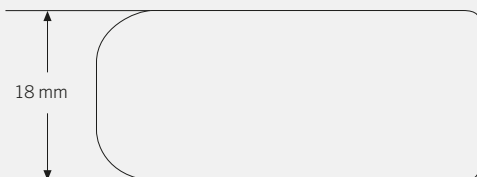
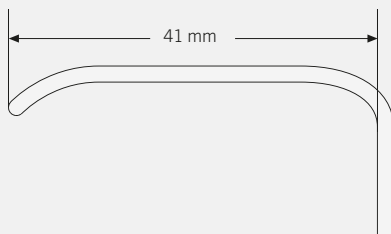
Ejemplo:

Exemple:

Esempio:

15-315-20-07

41 x 18 mm



**a** = Valventiefe  
Blade depth  
Profundidad de valva  
Profondeur de valve  
Profondità della valva

**c** = Armlänge  
Arm length  
Longitud de brazo  
Longueur de bras  
Lunghezza del braccio

**b** = Valvenbreite  
Blade width  
Anchura de valva  
Largeur de valve  
Larghezza della valva

**d** = Spreizweite  
Spreading width  
Anchura de extensión  
Largeur d'ouverture  
Ampiezza di apertura

|                    |                   |                                     |
|--------------------|-------------------|-------------------------------------|
| Pyramiden-Profil   | Teilung           | empfohlen für Nahtmaterial          |
| Diamond profile    | Profile structure | recommended for suture material     |
| Perfil piramidal   | División          | recomendado para suturas            |
| Profil pyramidal   | Division          | recommandé pour matériel de suture  |
| Profilo piramidale | Divisione         | raccomodato per materiale di sutura |

|  |                 |               |  |                  |
|--|-----------------|---------------|--|------------------|
|  | <b>Standard</b> | <b>0,5 mm</b> |  | <b>0-6 - 4-0</b> |
|--|-----------------|---------------|--|------------------|

|  |             |               |  |                  |
|--|-------------|---------------|--|------------------|
|  | <b>Mini</b> | <b>0,4 mm</b> |  | <b>4-0 - 6-0</b> |
|--|-------------|---------------|--|------------------|

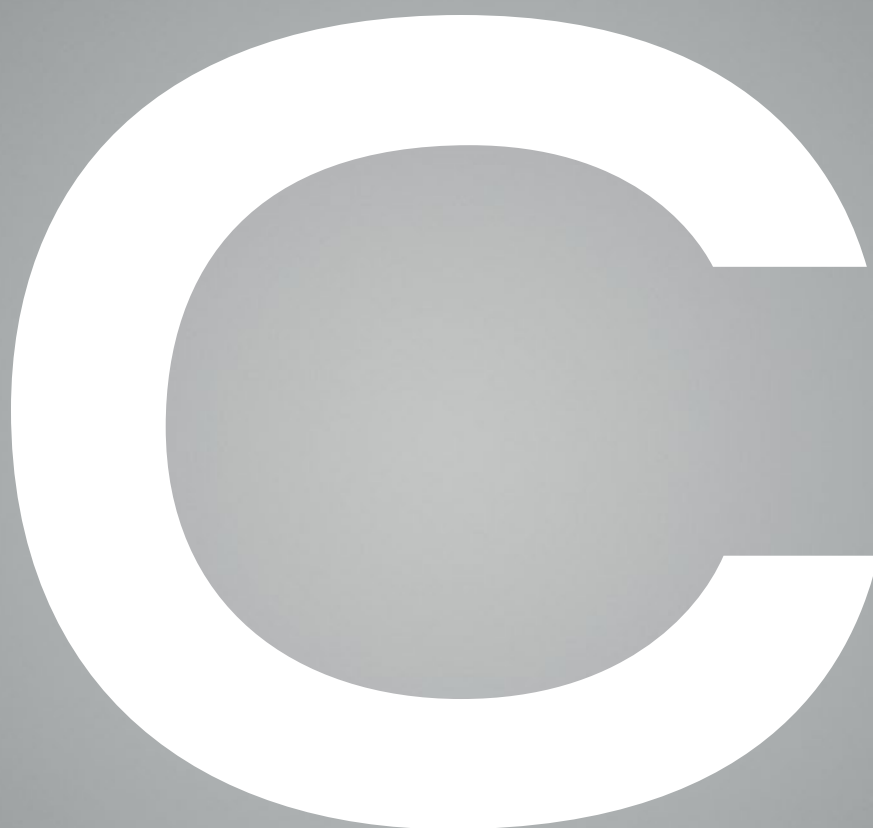
|  |              |               |  |                   |
|--|--------------|---------------|--|-------------------|
|  | <b>Micro</b> | <b>0,3 mm</b> |  | <b>5-0 - 12-0</b> |
|--|--------------|---------------|--|-------------------|

|  |               |          |  |                   |
|--|---------------|----------|--|-------------------|
|  | <b>Smooth</b> | <b>-</b> |  | <b>5-0 - 12-0</b> |
|--|---------------|----------|--|-------------------|



---

Übersichtstafel  
Table of Contents  
Tabla de catálogo  
Contenu  
Indice di catalogo



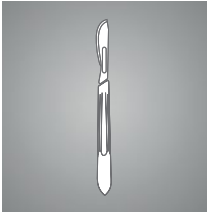
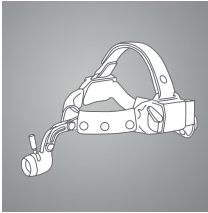

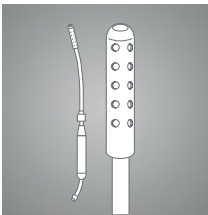







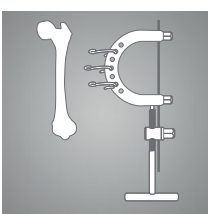
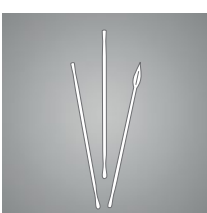
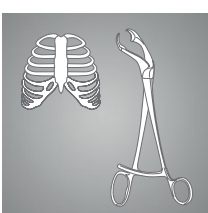
# Übersichtstafel

Table of Contents

Tabla de catálogo

Contenu

Indice di catalogo

|                      |   |   |                      |  |   |
|----------------------|---|---|----------------------|--|---|
| <b>10</b><br>1-14    |    | Skalpelle<br>Scalpels<br>Bisturíes<br>Bistouris<br>Bisturi  | <b>17</b><br>357-359 |    | Diagnostik<br>Diagnostics<br>Diagnóstico<br>Diagnostic<br>Diagnostica   |
| <b>11</b><br>15-124  |    | Scheren<br>Scissors<br>Tijeras<br>Ciseaux<br>Forbici  | <b>18</b><br>361-385 |    | Trokare, Sauger, Kanülen<br>Trocars, Suction Tubes, Cannulas<br>Trócares, Tubos de Aspiración, Cánulas<br>Trocarts, Tubes d'aspiration, Canules<br>Trequarti, Tubi d'aspirazione, Cannule |
| <b>12</b><br>125-156 |   | Pinzetten<br>Forceps<br>Pinzas<br>Pincas<br>Pinze   | <b>19</b><br>387-400 |   | Narkose<br>Anaesthesia<br>Anestesia<br>Anesthésie<br>Anestesia  |
| <b>13</b><br>157-215 |  | Arterienklemmen<br>Artery Forceps<br>Pinzas hemostáticas<br>Pincas hémostatiques<br>Pinze emostatiche   | <b>20</b><br>401-440 |  | Naht<br>Suture<br>Sutura<br>Suture<br>Sutura  |
| <b>14</b><br>217-223 |  | Tupfer- und Kornzangen<br>Cotton Swap Forceps etc.<br>Pinzas para tapones y curaciones<br>Pincas à tampons et à pansements<br>Pinze per tamponi e per medicazione   | <b>21</b><br>441-450 |  | Verband<br>Dressings<br>Vendajes<br>Pansements<br>Bendaggi  |
| <b>15</b><br>225-348 |  | Wundhaken<br>Retractors<br>Separadores<br>Ecarteurs<br>Divaricatori   | <b>22</b><br>451-454 |  | Knochenchirurgie*<br>Bone Surgery*<br>Cirugía ósea*<br>Chirurgie osseuse*<br>Chirurgia ossea*   |
| <b>16</b><br>349-355 |  | Sonden, Watteträger, Spatel<br>Probes, Applicators, Spatulas<br>Sondas, Porta-algodones, Espátulas<br>Sondes, porte-cotons, spatules<br>Sonde, portacotoni, spatole | <b>23</b><br>455-534 |  | Knochenchirurgie*<br>Bone Surgery*<br>Cirugía ósea*<br>Chirurgie osseuse*<br>Chirurgia ossea*   |

|                     |   |   |                           |  |  |
|---------------------|---|---|---------------------------|--|--|
| 24<br>535-537       |    | Herz-, Thorax- und Gefäßchirurgie*<br>Cardio Thoracic and Vascular Surgery*<br>Cirugía cardíaca, torácica y vascular*<br>Chirurgie cardiaque, thoracique<br>et vasculaire*<br>Chirurgia cardiaca, toracica e vascolare* | 31<br>589-598             |    | Urologie<br>Urology<br>Urología<br>Urologie<br>Urologia  |
| 24<br>539-541       |    | Neurochirurgie*<br>Neurosurgery*<br>Neurocirugía*<br>Neurochirurgie*<br>Neurochirurgia*   | 32<br>599-636             |    | Gynäkologie<br>Gynecology<br>Ginecología<br>Gynécologie<br>Ginecologia   |
| 25<br>26<br>543-545 |   | Implantat-Systeme CMF und Trauma*<br>Implant Systems CMF and Trauma*<br>Sistemas de implantes CMF y Trauma*<br>Systèmes d'implant CMF et Trauma*<br>Sistemi di impianto CMF e Trauma*                                   | 33<br>637-642             |   | Geburtshilfe<br>Obstetrics<br>Obstetricia<br>Obstétrique<br>Ostetricia   |
| 27<br>547-550       |  | Tracheotomie<br>Tracheotomy<br>Traqueotomía<br>Trachéotomie<br>Tracheotomia   | 35<br>643-645             |  | Messzirkel<br>Calipers<br>Compases<br>Compas<br>Compassi   |
| 28<br>551-753       |  | Kropfchirurgie, Dermatologie<br>Goitre, Dermatology<br>Bocio, Dermatología<br>Goitre, Dermatologie<br>Gozzo, Dermatologia   | 36<br>647-684             |  | Otologie<br>Otology<br>Otología<br>Otologie<br>Otologia  |
| 30<br>555-582       |  | Magen, Darm, Rektum<br>Stomach, Intestines, Rectum<br>Estómago, Intestinos, Recto<br>Estomac, Intestins, Rectum<br>Stomaco, Intestini, Retto  | 37<br>685-720             |  | Rhinologie<br>RhinoLOGY<br>Rinología<br>Rhinologie<br>Rinologia  |
| 31<br>583-588       |  | Leber, Galle, Niere<br>Liver, Gall bladder, Kidney<br>Higado, Biliares, Renales<br>Foie, Biliaire, Rénaux<br>Fegato, Biliari, Renali  | 38<br>721-724<br>48<br>50 |  | Mund-, Kiefer-, Gesichtschirurgie*<br>Oral Maxillo-Facial Surgery*<br>Cirugía oral y maxilofacial*<br>Chirurgie buccale et maxillo-faciale*<br>Chirurgia buccale e maxillo-facciale* |

# Übersichtstafel

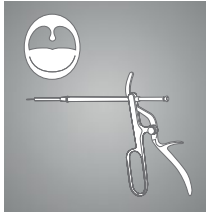
Table of Contents

Tabla de catálogo

Contenu

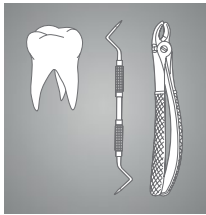
Indice di catalogo

**39**  
725-735



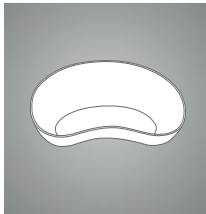
Tonsillektomie, Laryngo-Bronchoskopie  
Tonsillectomy, Laryngo-Bronchoscopy  
Tonsilectomía, Laringo-Bronchoscopia  
Tonsillectomie, Laryngo-Bronchoscopie  
Tonsilectomia, Laringo-Bronchoscopia

**40**  
**-47**  
737-739



Dental- und Oralchirurgie\*  
Dental and Oral Surgery\*  
Cirugía dental y oral\*  
Chirurgie dentaire et orale\*  
Chirurgia dentale e orale\*

**54**  
**-73**  
741-784



Verschiedenes  
Miscellaneous  
Diversos artículos  
Articles divers  
Articoli diversi

## Weitere Kataloge von KLS Martin

Zu den folgenden Produktgruppen sind jeweils eigene Kataloge verfügbar, die Sie gerne bei uns anfordern können:

## Further catalogs of KLS Martin

For the following product groups additional catalogs are available. Please ask for your personal copy:

## Más catálogos de KLS Martin

Para los grupos siguientes tenemos catálogos individuales disponibles. No duden pedirnos más ejemplares:

## Autres catalogues de KLS Martin

Pour les groupes de produits suivants sont disponibles des catalogues additionnels dont vous pouvez demander le nombre désiré:

## Altri cataloghi di KLS Martin

Per i gruppi di prodotti seguenti sono disponibili cataloghi addizionali. La preghiamo di informarci se desidera altre copie:

76 – 79 Laserchirurgie  
Laser Surgery  
Cirugía láser  
Chirurgie laser  
Chirurgia laser

80 Hochfrequenzchirurgie  
Electrosurgery  
Electrocirugía  
Électrochirurgicaux  
Elettrochirurgia

85 Deckenversorgungseinheiten  
Ceiling-mounting systems  
Unidades de alimentación de techo  
Unités d'alimentation montées au plafond  
Sistemi pensili

86 + 89 OP-Leuchten  
Operating Theatre Lights  
Lámparas de quirófano  
Lampes opératoires  
Lampade scialitiche

\* Siehe Spezialkatalog

See special catalog

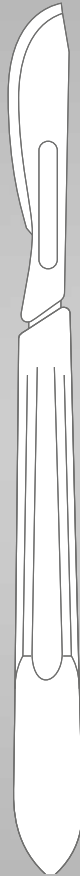
Véase catálogo especial

Voyez catalogue spécial

Vedete catalogo speciale

Skalpelle  
Scalpels  
Bisturíes  
Bistouris  
Bisturi

# 10



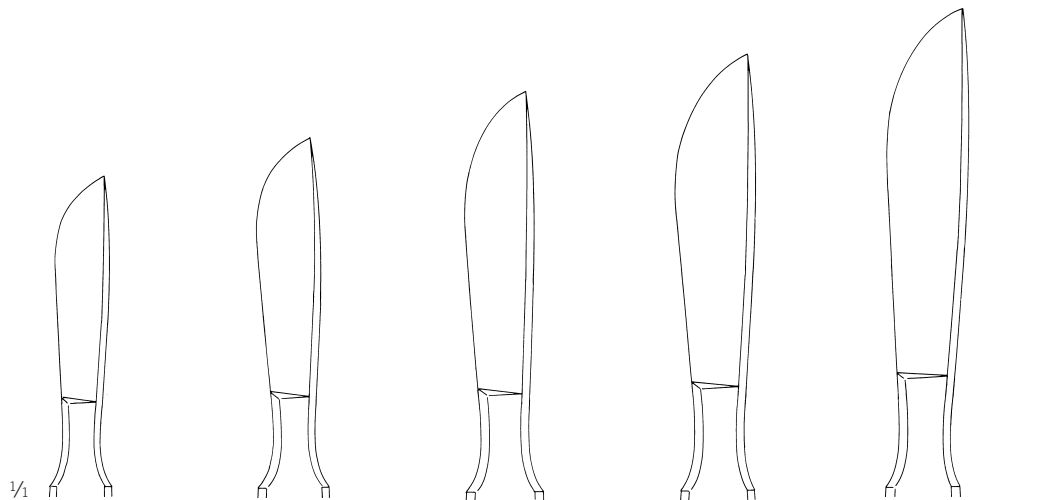
# Anatomische Skalpelle

Dissecting Knives

Bisturios para disección

Bistouris à dissection

Bisturi per dissezione



**Fig. 1**  
10-002-01-07  
15 cm / 5 7/8"



30 mm

**Fig. 2**  
10-002-02-07  
15 cm / 5 7/8"



36 mm

**Fig. 3**  
10-002-03-07  
15,5 cm / 6 1/8"



40 mm

**Fig. 4**  
10-002-04-07  
16 cm / 6 2/8"

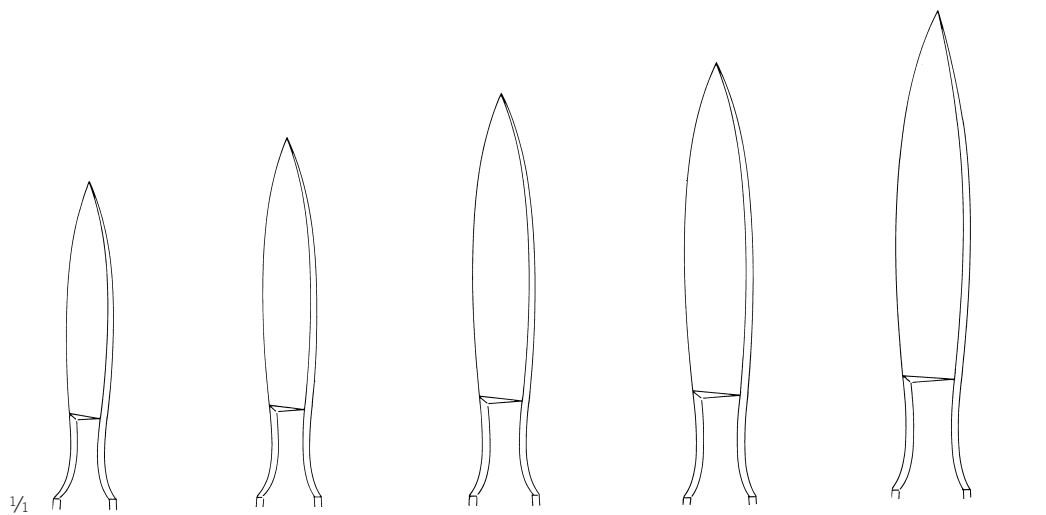


45 mm

**Fig. 5**  
10-002-05-07  
16 cm / 6 2/8"



50 mm



**Fig. 6**  
10-002-06-07  
15 cm / 5 7/8"



27 mm

**Fig. 7**  
10-002-07-07  
15 cm / 5 7/8"



35 mm

**Fig. 8**  
10-002-08-07  
16 cm / 6 2/8"



40 mm

**Fig. 9**  
10-002-09-07  
16 cm / 6 2/8"



47 mm

**Fig. 10**  
10-002-10-07  
17 cm / 6 6/8"



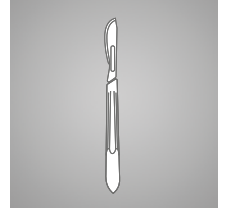
50 mm



10-002-01-07 -  
10-002-10-07

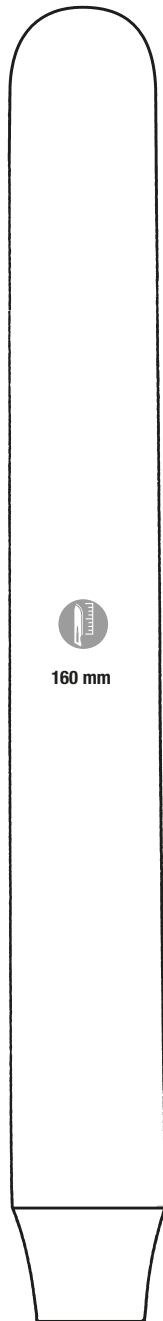
mit Metallheft  
with metal handle  
con mango metálico  
avec manche en métal  
con manico di metallo





1/2

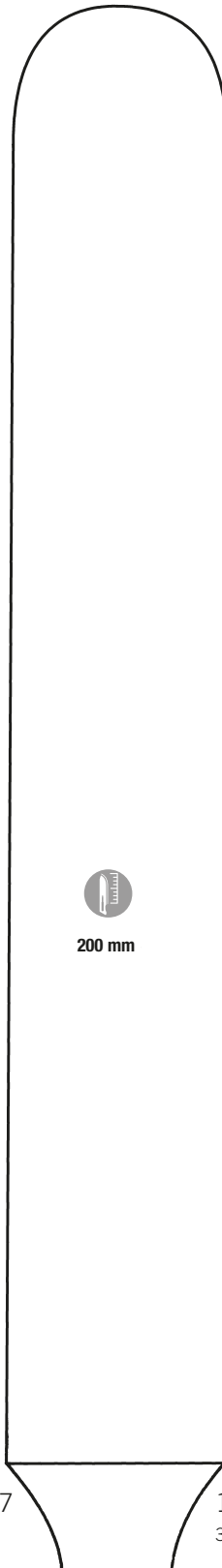
**Virchow**  
10-038-16-07 -  
10-038-24-07  
mit Hohlheft  
with hollow handle  
con mango hueco  
avec manche creux  
con manico vuoto



160 mm

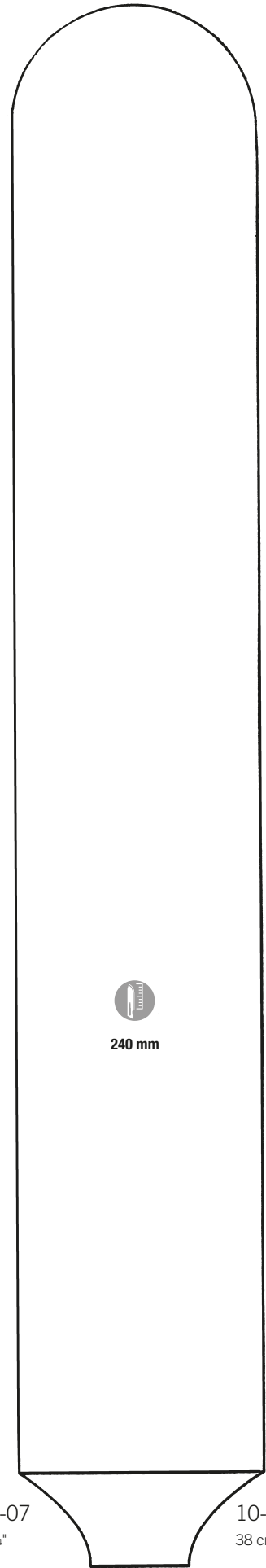
10-038-16-07  
26 cm / 10 1/4"

1/4



200 mm

10-038-20-07  
33,5 cm / 13 1/4"



240 mm

10-038-24-07  
38 cm / 15"

## Klingenthaler / Klingenbrecher

Blade Holders / Blade Breakers

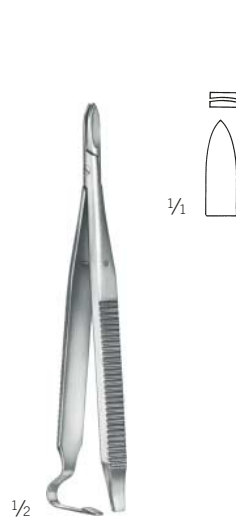
Porta-hojas / Rompe-hojas de afeitarse

Pincettes pour saisir et casser les lames de rasoir

Pinze per afferrare e rompere la lametta di rasoio



Troutman-Chris  
10-090-09-07  
9 cm / 3 4/8"



10-092-11-07  
11 cm / 4 3/8"



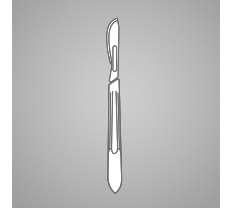
Castroviejo  
10-094-13-07  
13 cm / 5 1/8"

## Skalpellgriffe

Scalpel Handles  
Mangos de bisturí  
Manches pour bistouris  
Manici per bisturi

## Skalpelle

Scalpels  
Bisturíes  
Bistouris  
Bisturi



10-100-04-07  
13,5 cm / 5 3/8"  
massiv  
solid  
macizo  
solide  
pieno



10-100-34-07  
16 cm / 6 2/8"  
massiv  
solid  
macizo  
solide  
pieno



10-104-41-07  
21 cm / 8 2/8"  
massiv  
solid  
macizo  
solide  
pieno



10-104-45-07  
20,5 cm / 8 1/8"  
massiv  
solid  
macizo  
solide  
pieno

## Skalpellgriffe

Scalpel Handles

Mangos de bisturí

Manches pour bistouris

Manici per bisturi



Fig. 18 - 36

1/2

Nr. 9



Fig. 18 - 36

1/2

Nr. 4

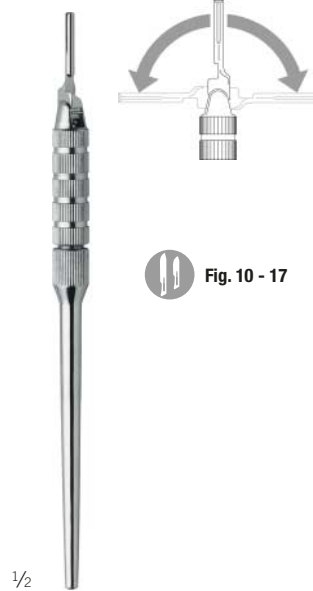


Fig. 10 - 17

1/2

### Collin

10-109-09-07

14,5 cm / 5 9/16"

mit Hohlheft  
with hollow handle  
con mango hueco  
avec manche creux  
con manico vuoto

10-112-04-07

13,5 cm / 5 3/8"

mit Kunststoffheft  
with plastic handle  
con mango plástico  
avec manche en matière plastique  
con mango plástico

10-118-03-07

15,5 cm / 6 1/8"

Schwenkkopf  
swivel head  
con cabeza orientable  
à tête pivotante  
con testa inclinabile



Fig. 10 - 17

1/2

10-120-04-07

16,5 cm / 6 2/8"



Fig. 10 - 17

1/2

Nr. 3

10-130-03-07

12 cm / 4 9/16"

massiv  
solid  
macizo  
solide  
pieno



Fig. 10 - 17

1/2

Nr. 3

10-130-04-07

12 cm / 4 9/16"

massiv  
solid  
macizo  
solide  
pieno



Fig. 10 - 17

1/2

Nr. 3

10-130-05-07

12 cm / 4 9/16"

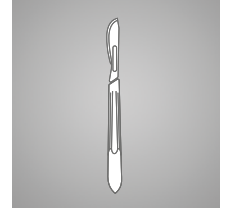
massiv, mit Zentimeter-  
Graduierung  
solid, cm-graduation  
macizo, graduado en cm  
solide, gradué en cm  
pieno, graduato in cm

## Skalpellgriffe

Scalpel Handles  
Mangos de bisturí  
Manches pour bistouris  
Manici per bisturi

## Skalpelle

Scalpels  
Bisturíes  
Bistouris  
Bisturi



10



 Fig. 10 - 17

$\frac{1}{2}$  Nr. 3L

10-133-31-07

21,5 cm / 8  $\frac{4}{8}$ "

massiv, lang  
solid, long  
macizo, largo  
solide, long  
pieno, lungo



 Fig. 10 - 17

$\frac{1}{2}$  Nr. 3L

10-133-35-07

20,5 cm / 8  $\frac{1}{8}$ "

massiv, lang  
solid, long  
macizo, largo  
solide, long  
pieno, lungo



 Fig. 10 - 17

$\frac{1}{2}$  Nr. 3XL

10-135-01-07

26 cm / 10  $\frac{2}{8}$ "

massiv, lang  
solid, long  
macizo, largo  
solide, long  
pieno, lungo

## Skalpgriffe

Scalpel Handles

Mangos de bisturi

Manches pour bistouris

Manici per bisturi



Fig. 10 - 17

1/2 Nr. 7

10-137-07-07

16 cm / 6 7/8"

massiv  
solid  
macizo  
solide  
pieno



Fig. 10 - 17

1/2 Nr. 7K

10-137-71-07

12,5 cm / 4 7/8"

massiv  
solid  
macizo  
solide  
pieno



Fig. 10 - 17

1/2 Nr. 3

10-140-03-07

15,5 cm / 6 1/8"

mit rundem Hohlheft  
with round hollow handle  
con mango hueco redondo  
avec manche creux rond  
con manico vuoto rotondo



Fig. 10 - 17

1/2 Nr. 3

10-142-03-07

12,5 cm / 4 7/8"

mit Kunststoffheft  
with plastic handle  
con mango plástico  
avec manche en matière plastique  
con manico di materia plastica



Fig. 10 - 17

1/2 Nr. 3

10-146-03-07

14 cm / 5 4/8"

massiv  
solid  
macizo  
solide  
pieno



Fig. 10 - 17

1/2 Nr. 3

10-147-03-07

14 cm / 5 4/8"

massiv  
solid  
macizo  
solide  
pieno



Fig. 10 - 17

1/2 Nr. 3

Kaye

10-148-03-07

15 cm / 5 7/8"

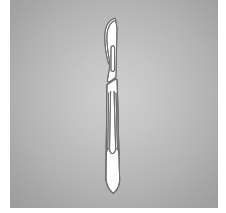
massiv  
solid  
macizo  
solide  
pieno

## Skalpellklingen

Scalpel Blades  
Hojas de bisturí  
Lames de bistouris  
Lame per bisturi

## Skalpelle

Scalpels  
Bisturíes  
Bistouris  
Bisturi



einzel verpackt, VE = 100 Stück  
single packed, SU = 100/pack  
envase individual, UV = 100 piezas  
enveloppe individuelle, UC = 100 untiés  
bustina individuale, UV = 100 pezzi



10-199-00-01

Skalpellklingen-Entferner  
Scalpel Blade Remover  
Quita-hojas  
Enlève-lame  
Distributore lame

10

1/1



|                   | Fig. 10      | Fig. 11      | Fig. 12      | Fig. 12 D    | Fig. 15      | Fig. 15 C    |
|-------------------|--------------|--------------|--------------|--------------|--------------|--------------|
| <b>STERILE IR</b> | 10-155-10-04 | 10-155-11-04 | 10-155-12-04 | 10-156-12-04 | 10-155-15-04 | 10-156-15-04 |

1/1



|                   | Fig. 18      | Fig. 20      | Fig. 21      | Fig. 22      | Fig. 23      | Fig. 24      | Fig. 36      |
|-------------------|--------------|--------------|--------------|--------------|--------------|--------------|--------------|
| <b>STERILE IR</b> | 10-155-18-04 | 10-155-20-04 | 10-155-21-04 | 10-155-22-04 | 10-155-23-04 | 10-155-24-04 | 10-155-36-04 |

## Skalpellgriffe

Scalpel Handles

Mangos de bisturí

Manches pour bistouris

Manici per bisturi



1/1

10-160-01-07

13,5 cm / 5 <sup>3</sup>/<sub>8</sub>"

für Mikro-Skalpellklingen

for micro scalpel blades

para micro hojas

pour micro-lames de bisturis

per micro lame



## Einmalskalpelle

Disposable Scalpels  
Bisturíes desechables  
Bistouris à usage unique  
Bisturi per uso unico

## Skalpelle

Scalpels  
Bisturíes  
Bistouris  
Bisturi



### STERILE | R

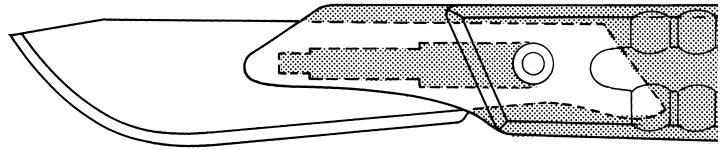
steril  
einzeln verpackt  
Packung mit 10 Stück

sterile  
single packed  
package with 10 units

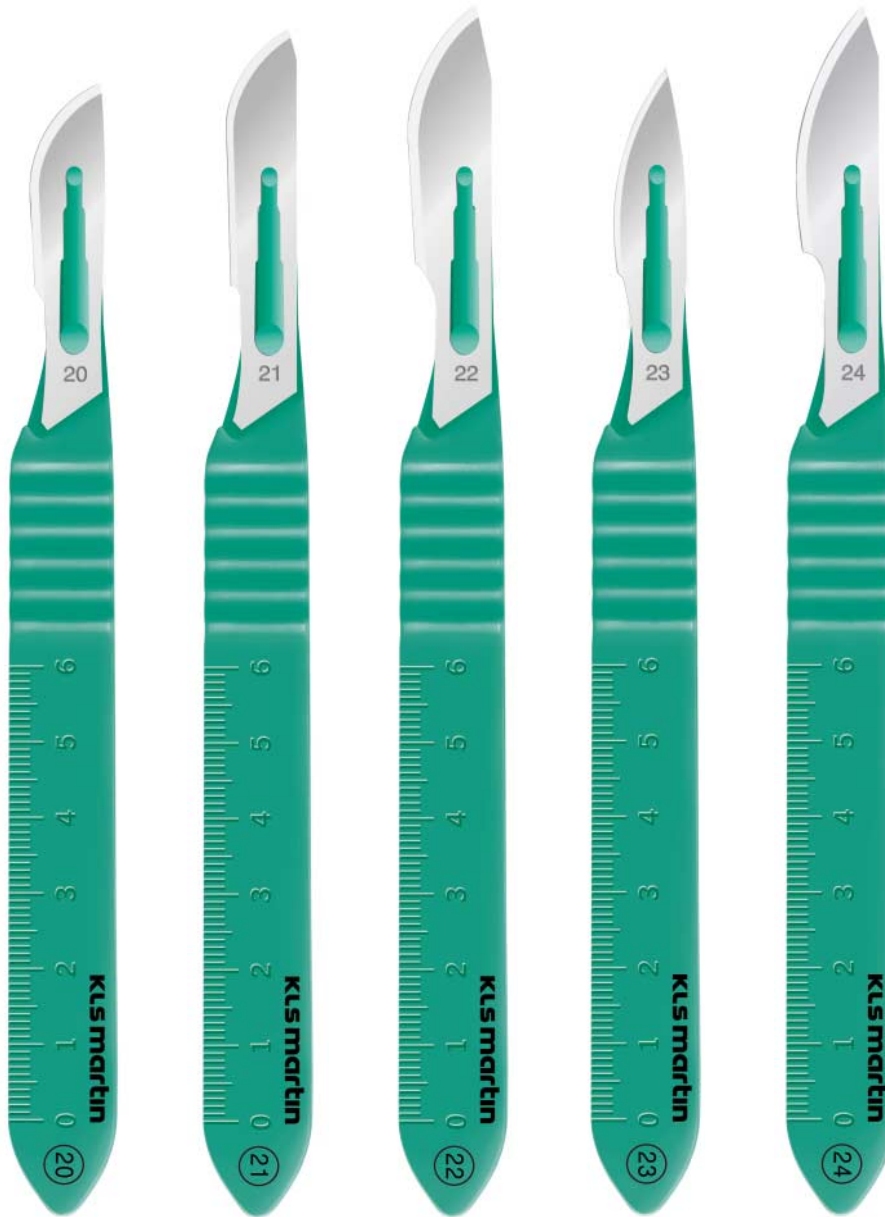
estéril  
envase individual  
paquete con 10 unidades

stérile  
enveloppe individuelle  
boîte de 10 bisturis

sterile  
bustina individuale  
scatola di 10 bisturi



10



1/1

|             | Fig. 20      | Fig. 21      | Fig. 22      | Fig. 23      | Fig. 24      |
|-------------|--------------|--------------|--------------|--------------|--------------|
| STERILE   R | 10-285-20-04 | 10-285-21-04 | 10-285-22-04 | 10-285-23-04 | 10-285-24-04 |

**Einmalskalpelle**  
 Disposable Scalpels  
 Bisturios desechables  
 Bistouris à usage unique  
 Bisturi per uso unico

**STERILE | R**

steril  
 einzeln verpackt  
 Packung mit 10 Stück

stérile  
 enveloppe individuelle  
 boîte de 10 bisturis

sterile  
 single packed  
 package with 10 units

sterile  
 bustina individuale  
 scatola di 10 bisturi

estéril  
 envase individual  
 paquete con 10 unidades



1/1

|                    | Fig. 10      | Fig. 11      | Fig. 12      | Fig. 15      | Fig. 12 D    | Fig. 15 C    |
|--------------------|--------------|--------------|--------------|--------------|--------------|--------------|
| <b>STERILE   R</b> | 10-295-10-04 | 10-295-11-04 | 10-295-12-04 | 10-295-15-04 | 10-296-12-04 | 10-296-15-04 |

## Amputationsmesser, Resektionsmesser

Amputation Knives, Resection Knives

Cuchillos para amputación, Cuchillos para resección

Couteaux à amputation, Couteaux à résection

Coltelli per amputazione, Coltelli per resezione

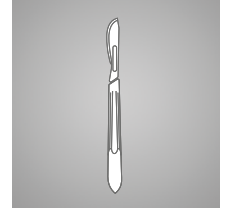
## Skalpelle

Scalpels

Bisturíes

Bistouris

Bisturi



Liston  
10-500-19-07  
32 cm / 12 5/8"  
mit Hohlheft  
with hollow handle  
con mango hueco  
avec manche creux  
con manico vuoto



10-560-06-07  
19 cm / 7 4/8"  
massives Heft mit Schaber-Ende  
solid handle, with dissecting end  
mango macizo, con periostótomo  
manche solide à rugine  
con manico pieno con raschino

## Dermatom

Dermatome  
Dermatomo  
Dermatome  
Dermatomo a mano



1/2

Humby  
10-878-00-07

32 cm / 12 5/8"

komplett mit Klinge  
complete with blade  
completo con hoja  
complet avec lame  
completo con lama

Humby  
10-878-01-07

Ersatzklinge  
Spare Blade  
Hoja de repuesto  
Lame de rechange, seule  
Lama di ricambio sola

➔ 10-878-00-07



1/2

Schink  
10-880-00-07

30 cm / 11 9/16"

einstellbar von 0,1 bis 2,0 mm  
adjustable from 0.1 to 2.0 mm  
ajustable de 0,1 hasta 2,0 mm  
réglable en épaisseur de 0,1 à 2,0 mm  
regolabile da 1,0 a 2,0 mm

komplett mit 2 Spannplatten und einer Klinge  
complete with 2 skin fixing plates and one blade  
completo con 2 placas para extender la piel y una hoja  
complet avec deux plaques pour tendre la peau et une lame  
completo con 2 placche per stendere la pelle ed una lama

Schink  
10-880-01-07

Ersatzklinge  
Spare Blade  
Hoja de repuesto  
Lame de rechange, seule  
Lama di ricambio sola

➔ 10-880-00-07



1/2

Schink  
10-880-02-07

Spannplatte  
Skin Fixing Plate  
Placa para extender la piel  
Plaque pour tendre la peau  
Placca per stendere la pelle

➔ 10-880-00-07



1/2

Silver  
10-882-19-07

19,5 cm / 7 5/8"

Handdermatom  
Dermatome  
Dermatomo  
Dermatome  
Dermatomo a mano

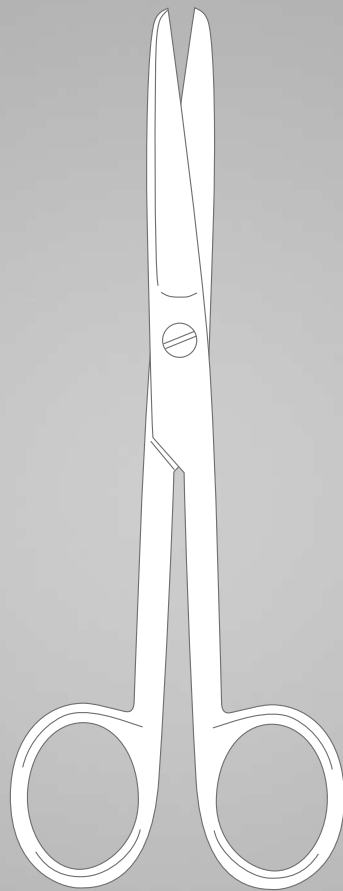
Silver  
10-882-90-98

Ersatzklingen, Packung mit 10 Stück  
Spare Blades, package with 10 units  
Hojas de repuesto, paquete con 10 unidades  
Lames de rechange, boîte de 10 lames  
Lamette da ricambio, scatola di 10 lamette

➔ 10-882-19-07

Scheren  
Scissors  
Tijeras  
Ciseaux  
Forbici

# 11



# Chirurgische Scheren

Operating Scissors

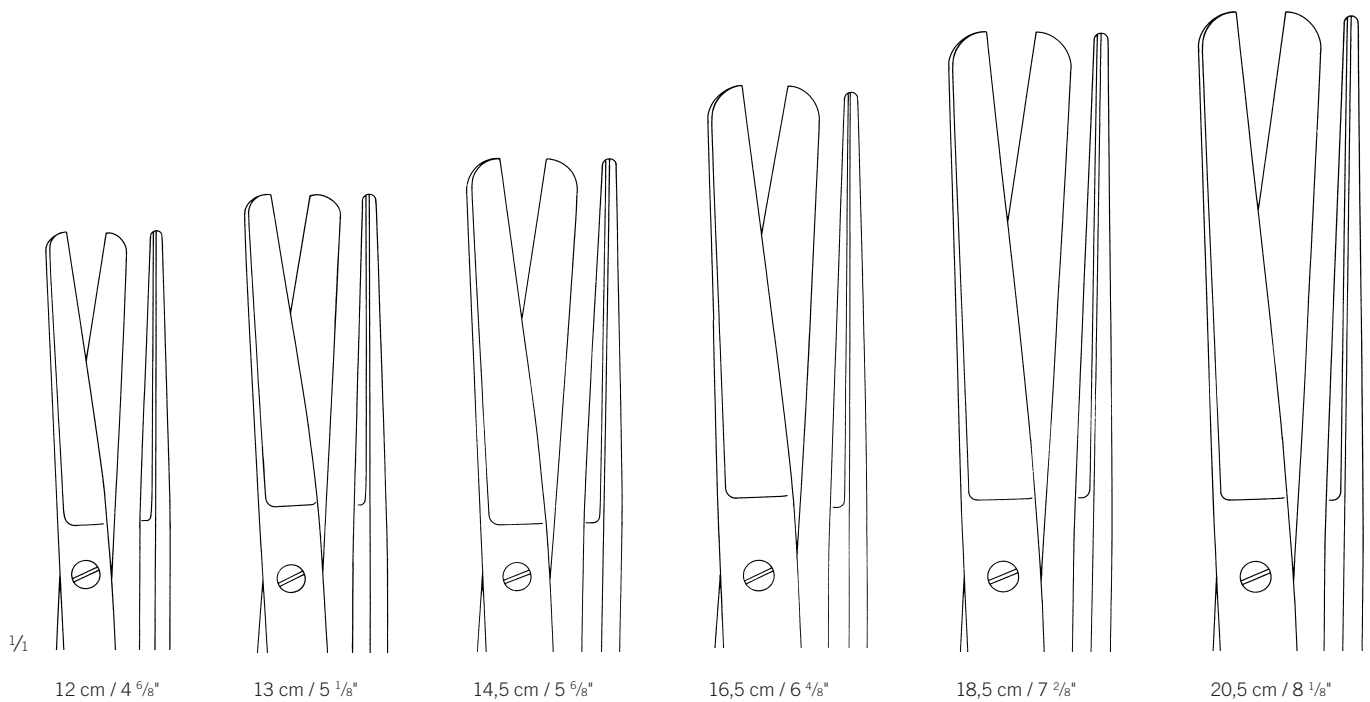
Tijeras quirúrgicas

Ciseaux chirurgicaux

Forbici per chirurgia



|                  | Standard     | TCGOLD       |
|------------------|--------------|--------------|
| 12 cm / 4 5/8"   | 11-100-11-07 |              |
| 13 cm / 5 1/8"   | 11-100-13-07 |              |
| 14,5 cm / 5 5/8" | 11-100-14-07 | 11-902-14-07 |
| 16,5 cm / 6 4/8" | 11-100-16-07 |              |
| 18,5 cm / 7 2/8" | 11-100-18-07 |              |
| 20,5 cm / 8 1/8" | 11-100-20-07 |              |



1/1

12 cm / 4 5/8"

13 cm / 5 1/8"

14,5 cm / 5 5/8"

16,5 cm / 6 4/8"

18,5 cm / 7 2/8"

20,5 cm / 8 1/8"

# Chirurgische Scheren

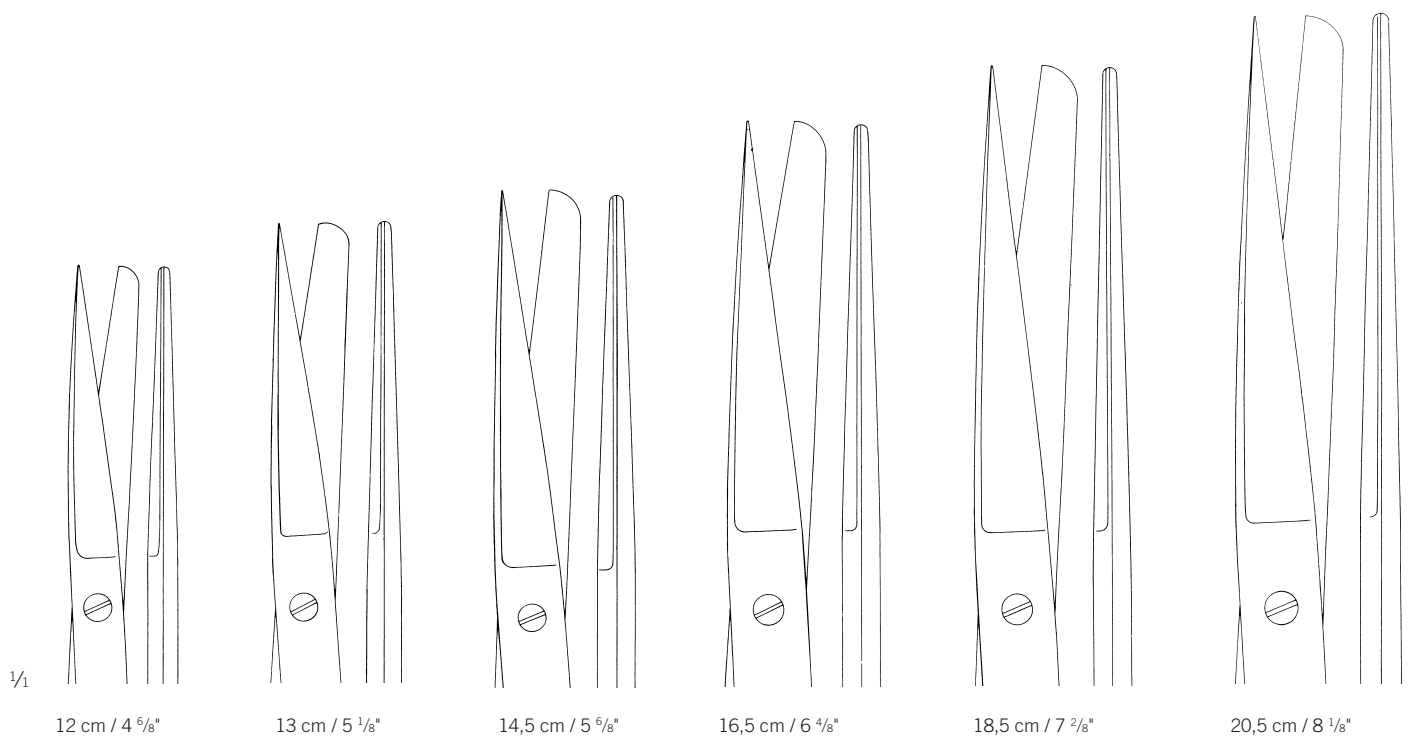
Operating Scissors  
Tijeras quirúrgicas  
Ciseaux chirurgicaux  
Forbici per chirurgia

# Scheren

Scissors  
Tijeras  
Ciseaux  
Forbici



|                  | Standard     | TCGOLD       | SuperCut     |
|------------------|--------------|--------------|--------------|
| 12 cm / 4 5/8"   | 11-102-11-07 |              |              |
| 13 cm / 5 1/8"   | 11-102-13-07 |              |              |
| 14,5 cm / 5 6/8" | 11-102-14-07 | 11-904-14-07 | 11-650-14-07 |
| 16,5 cm / 6 4/8" | 11-102-16-07 |              |              |
| 18,5 cm / 7 2/8" | 11-102-18-07 |              |              |
| 20,5 cm / 8 1/8" | 11-102-20-07 |              |              |



12 cm / 4 5/8"

13 cm / 5 1/8"

14,5 cm / 5 6/8"

16,5 cm / 6 4/8"

18,5 cm / 7 2/8"

20,5 cm / 8 1/8"

# Chirurgische Scheren

Operating Scissors

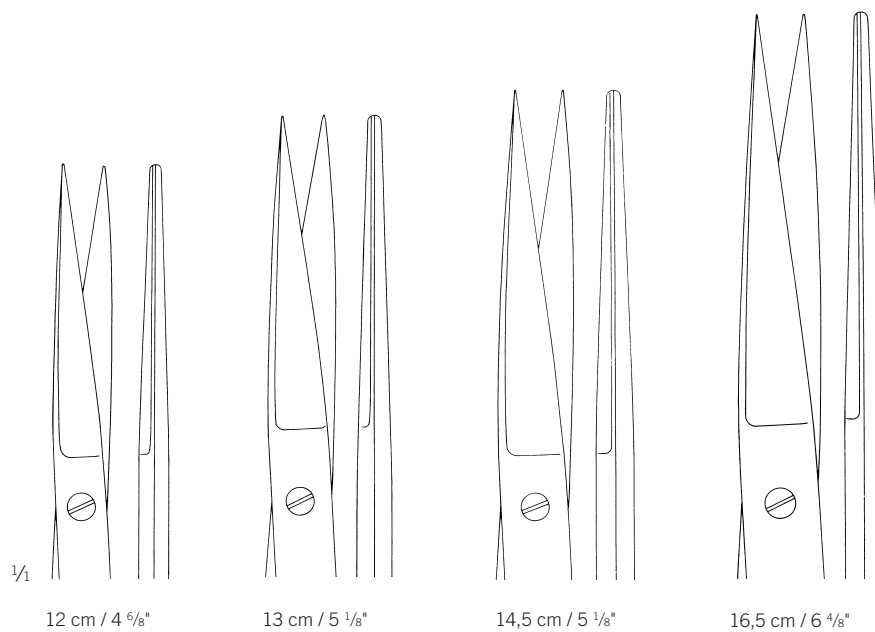
Tijeras quirúrgicas

Ciseaux chirurgicaux

Forbici per chirurgia



|                  | Standard     | TCGOLD       |
|------------------|--------------|--------------|
| 12 cm / 4 5/8"   | 11-104-11-07 |              |
| 13 cm / 5 1/8"   | 11-104-13-07 |              |
| 14,5 cm / 5 5/8" | 11-104-14-07 | 11-906-14-07 |
| 16,5 cm / 6 4/8" | 11-104-16-07 |              |





# Chirurgische Scheren

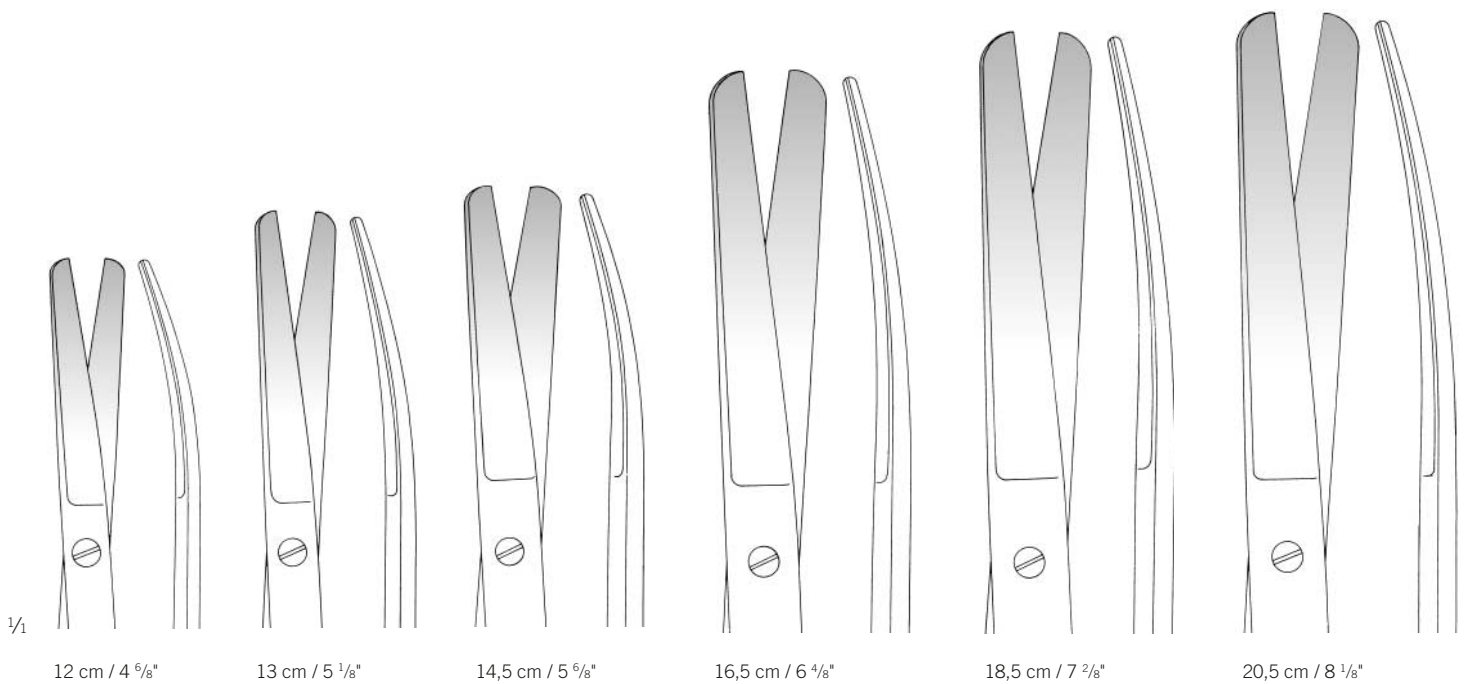
Operating Scissors  
Tijeras quirúrgicas  
Ciseaux chirurgicaux  
Forbici per chirurgia

# Scheren

Scissors  
Tijeras  
Ciseaux  
Forbici



|                  | Standard     | TCGOLD       |
|------------------|--------------|--------------|
| 12 cm / 4 5/8"   | 11-105-11-07 |              |
| 13 cm / 5 1/8"   | 11-105-13-07 |              |
| 14,5 cm / 5 6/8" | 11-105-14-07 | 11-903-14-07 |
| 16,5 cm / 6 4/8" | 11-105-16-07 |              |
| 18,5 cm / 7 2/8" | 11-105-18-07 |              |
| 20,5 cm / 8 1/8" | 11-105-20-07 |              |

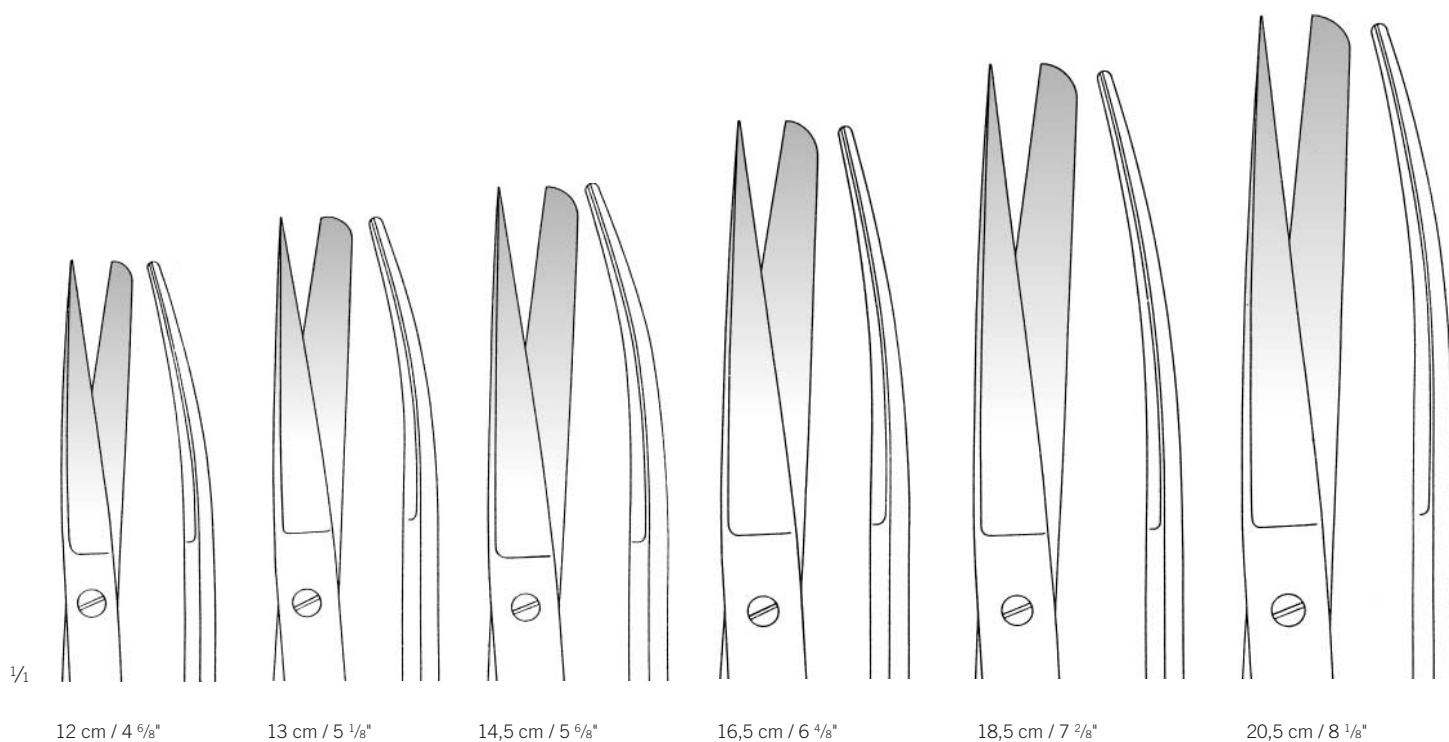


# Chirurgische Scheren

Operating Scissors  
 Tijeras quirúrgicas  
 Ciseaux chirurgicaux  
 Forbici per chirurgia



|                  | Standard     | TCGOLD       | SuperCut     |
|------------------|--------------|--------------|--------------|
| 12 cm / 4 5/8"   | 11-107-11-07 |              |              |
| 13 cm / 5 1/8"   | 11-107-13-07 |              |              |
| 14,5 cm / 5 7/8" | 11-107-14-07 | 11-905-14-07 | 11-651-14-07 |
| 16,5 cm / 6 4/8" | 11-107-16-07 |              |              |
| 18,5 cm / 7 2/8" | 11-107-18-07 |              |              |
| 20,5 cm / 8 1/8" | 11-107-20-07 |              |              |



12 cm / 4 5/8"

13 cm / 5 1/8"

14,5 cm / 5 7/8"

16,5 cm / 6 4/8"

18,5 cm / 7 2/8"

20,5 cm / 8 1/8"

# Chirurgische Scheren

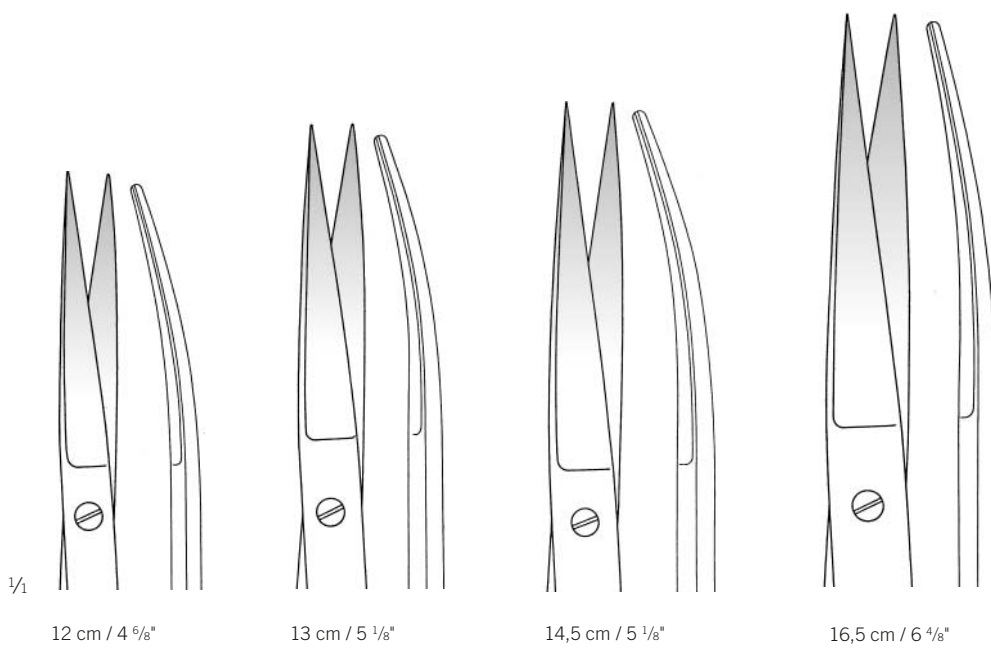
Operating Scissors  
Tijeras quirúrgicas  
Ciseaux chirurgicaux  
Forbici per chirurgia

# Scheren

Scissors  
Tijeras  
Ciseaux  
Forbici



|                  | Standard     | TCGOLD       |
|------------------|--------------|--------------|
| 12 cm / 4 5/8"   | 11-109-11-07 |              |
| 13 cm / 5 1/8"   | 11-109-13-07 |              |
| 14,5 cm / 5 7/8" | 11-109-14-07 | 11-907-14-07 |
| 16,5 cm / 6 4/8" | 11-109-16-07 |              |



1/1

12 cm / 4 5/8"

13 cm / 5 1/8"

14,5 cm / 5 7/8"

16,5 cm / 6 4/8"

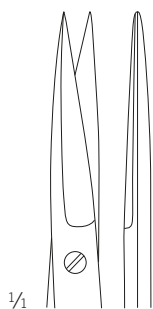
# Chirurgische Scheren

Operating Scissors

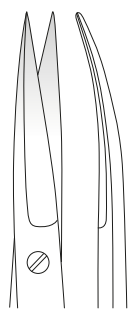
Tijeras quirúrgicas

Ciseaux chirurgicaux

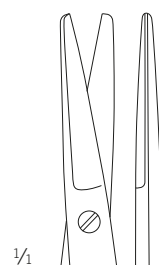
Forbici per chirurgia



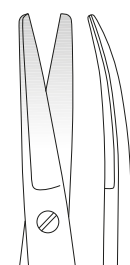
11-110-01-07



11-110-02-07



11-110-03-07



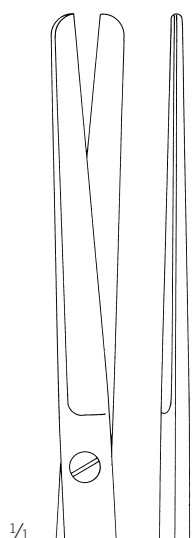
11-110-04-07

11-110-01-07 -  
11-110-02-07

11 cm / 4 3/8"

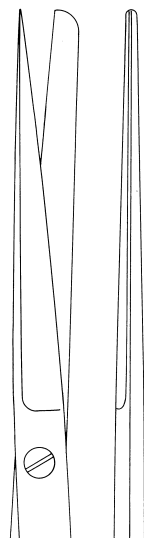
Knapp  
11-110-03-07 -  
11-110-04-07

12 cm / 4 6/8"



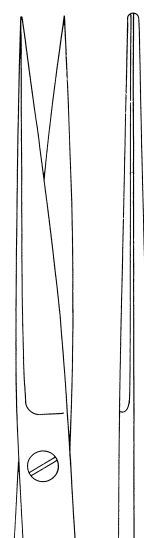
11-120-14-07

14,5 cm / 5 6/8"



11-122-14-07

14,5 cm / 5 6/8"



11-124-14-07

14,5 cm / 5 6/8"

11-120-14-07 -  
11-124-14-07

## Chirurgische Scheren

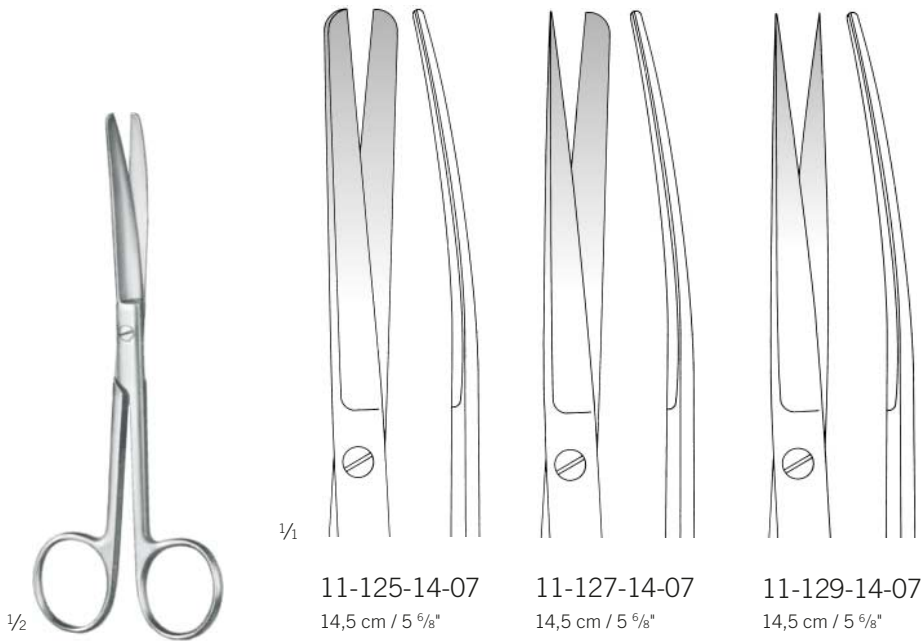
Operating Scissors  
Tijeras quirúrgicas  
Ciseaux chirurgicaux  
Forbici per chirurgia

## Scheren

Scissors  
Tijeras  
Ciseaux  
Forbici



11



1/4

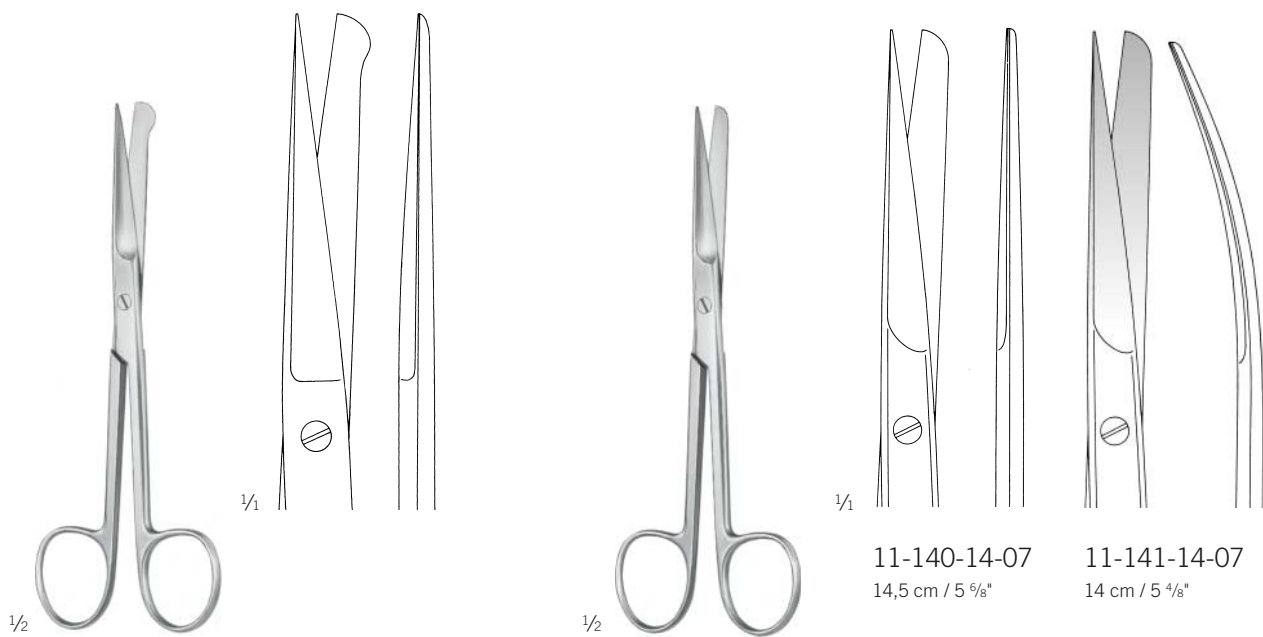
11-125-14-07  
14,5 cm / 5 7/8"

11-127-14-07  
14,5 cm / 5 7/8"

11-129-14-07  
14,5 cm / 5 7/8"

1/2

11-125-14-07 -  
11-129-14-07



1/4

1/4

11-140-14-07  
14,5 cm / 5 7/8"

11-141-14-07  
14 cm / 5 4/8"

1/2

1/2

11-136-14-07  
14,5 cm / 5 7/8"  
Inzisionschere  
Incision Scissors  
Tijera para incisiones  
Ciseaux à incision  
Forbici per incisione

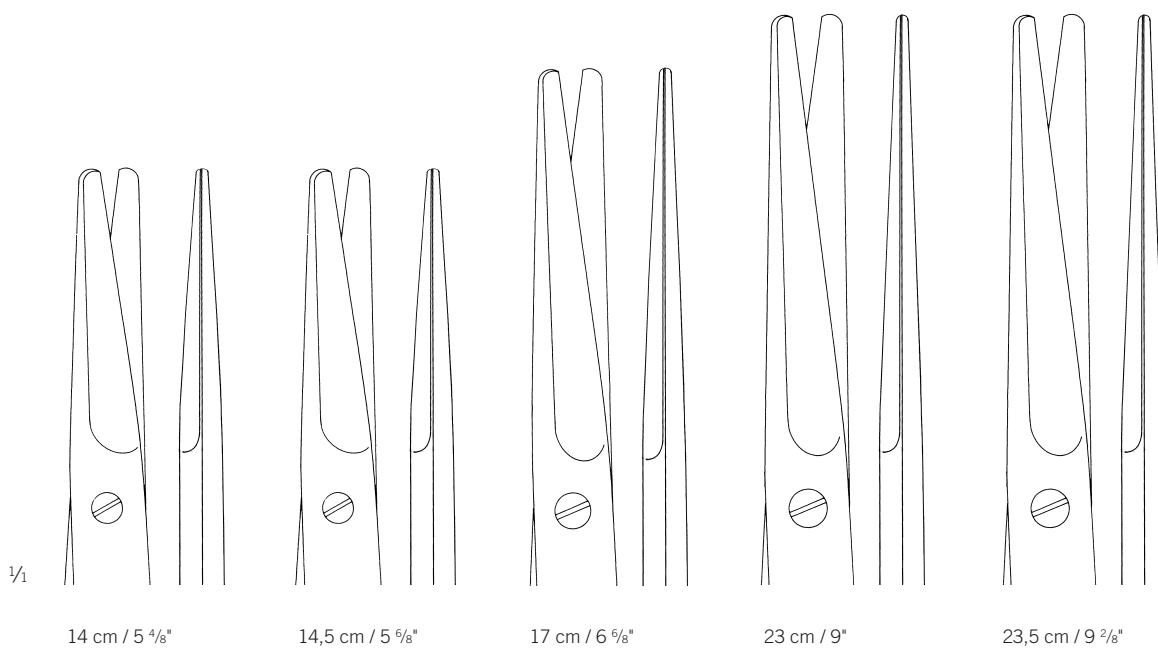
Deaver  
11-140-14-07 -  
11-141-14-07

# Chirurgische Scheren

Operating Scissors  
Tijeras quirúrgicas  
Ciseaux chirurgicaux  
Forbici per chirurgia



| Mayo             | Standard     | TC GOLD      | SuperCut     | ST           | AQUILA       |
|------------------|--------------|--------------|--------------|--------------|--------------|
| 14 cm / 5 4/8"   |              |              |              | 28-408-14-07 | 28-466-14-07 |
| 14,5 cm / 5 6/8" | 11-170-14-07 | 11-910-14-07 | 11-652-14-07 |              |              |
| 17 cm / 6 6/8"   | 11-170-17-07 | 11-910-17-07 | 11-652-17-07 | 28-408-17-07 | 28-466-17-07 |
| 23 cm / 9"       |              | 11-910-23-07 |              |              |              |
| 23,5 cm / 9 2/8" | 11-170-23-07 |              | 11-652-23-07 |              |              |



14 cm / 5 4/8"

14,5 cm / 5 6/8"

17 cm / 6 6/8"

23 cm / 9"

23,5 cm / 9 2/8"

# Chirurgische Scheren

Operating Scissors  
Tijeras quirúrgicas  
Ciseaux chirurgicaux  
Forbici per chirurgia

# Scheren

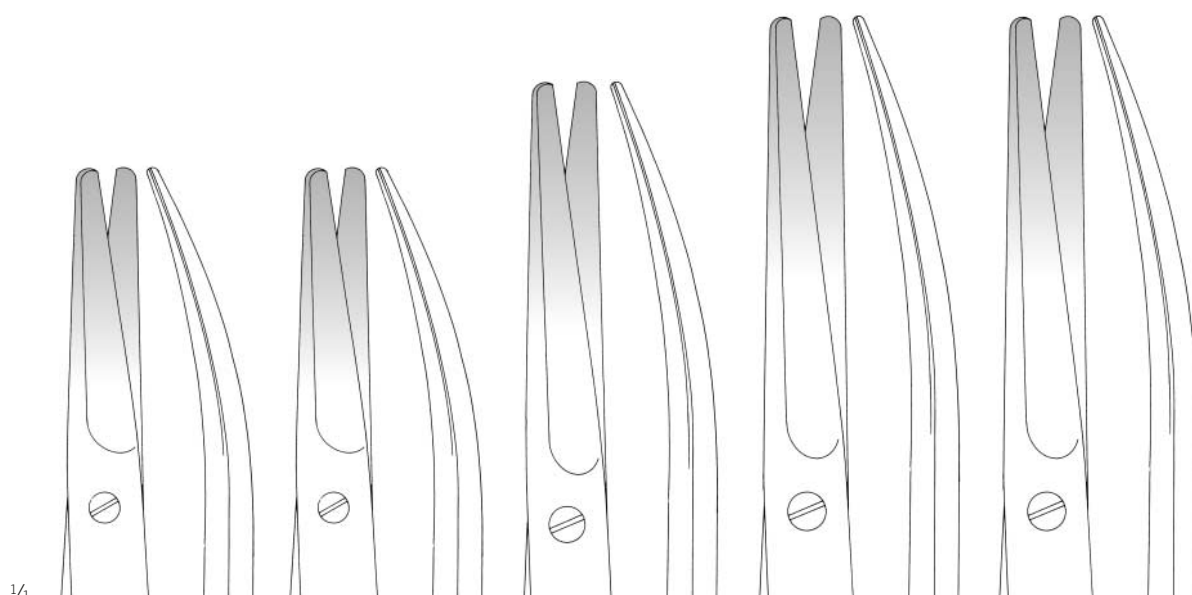
Scissors  
Tijeras  
Ciseaux  
Forbici



11



| Mayo             | Standard     | TCGOLD       | SuperCut     | ST           | AQUILA       |
|------------------|--------------|--------------|--------------|--------------|--------------|
| 14 cm / 5 1/8"   |              |              |              | 28-409-14-07 | 28-467-14-07 |
| 14,5 cm / 5 7/8" | 11-171-14-07 | 11-911-14-07 | 11-653-14-07 |              |              |
| 17 cm / 6 5/8"   | 11-171-17-07 | 11-911-17-07 | 11-653-17-07 | 28-409-17-07 | 28-467-17-07 |
| 23 cm / 9"       |              | 11-911-23-07 |              |              |              |
| 23,5 cm / 9 1/8" | 11-171-23-07 |              | 11-653-23-07 |              |              |



14 cm / 5 1/8"

14,5 cm / 5 7/8"

17 cm / 6 5/8"

23 cm / 9"

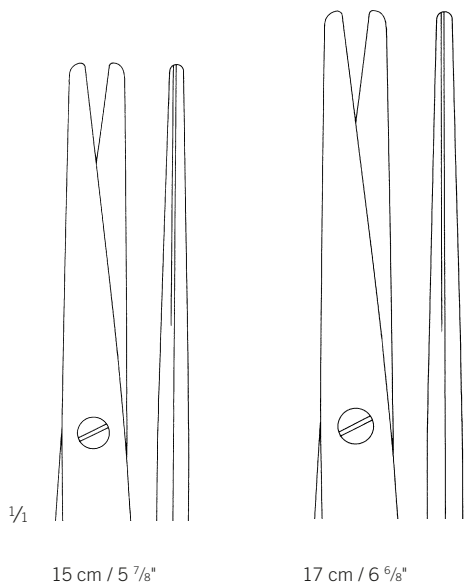
23,5 cm / 9 1/8"

# Präparierscheren

Dissecting Scissors  
 Tijeras de disección  
 Ciseaux à dissection  
 Forbici per dissezione



| Mayo-Style     | Standard     | TCGOLD       | SuperCut     |
|----------------|--------------|--------------|--------------|
| 15 cm / 5 7/8" | 11-180-15-07 | 11-930-15-07 | 11-654-15-07 |
| 17 cm / 6 5/8" | 11-180-17-07 | 11-930-17-07 | 11-654-17-07 |





## Präparierscheren

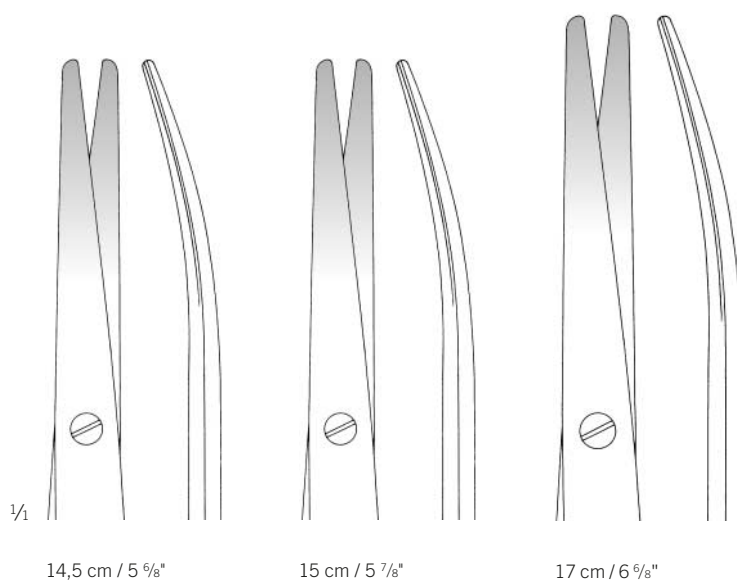
Dissecting Scissors  
Tijeras de disección  
Ciseaux à dissection  
Forbici per dissezione

## Scheren

Scissors  
Tijeras  
Ciseaux  
Forbici



| Mayo-Stille      | Standard     | TC GOLD      | SuperCut     | ST           | AQUILA       |
|------------------|--------------|--------------|--------------|--------------|--------------|
| 14,5 cm / 5 7/8" |              | 11-931-15-07 |              |              |              |
| 15 cm / 5 7/8"   | 11-181-15-07 |              | 11-655-15-07 | 28-413-15-07 | 28-471-15-07 |
| 17 cm / 6 5/8"   | 11-181-17-07 | 11-931-17-07 | 11-655-17-07 | 28-413-17-07 | 28-471-17-07 |



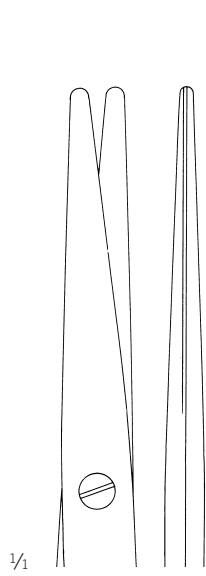
# Präparierscheren

Dissecting Scissors

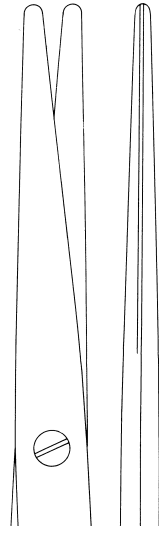
Tijeras de disección

Ciseaux à dissection

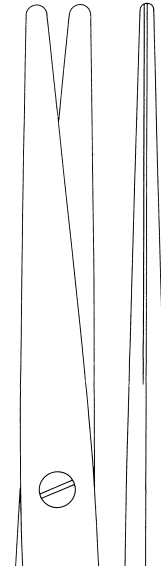
Forbici per dissezione



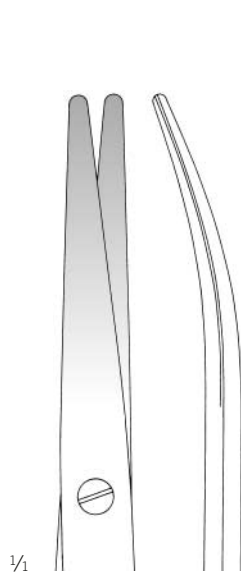
11-184-16-07  
16 cm / 6 2/8"



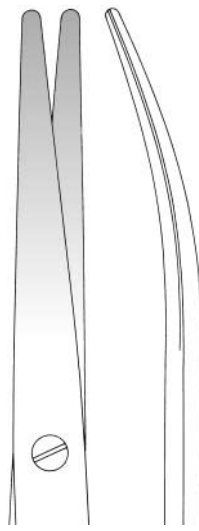
11-184-19-07  
19,5 cm / 7 5/8"



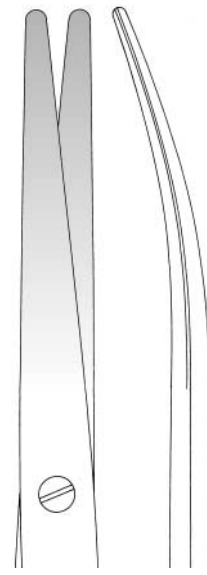
11-184-21-07  
21,5 cm / 8 4/8"



11-185-16-07  
16 cm / 6 2/8"



11-185-19-07  
19,5 cm / 7 5/8"



11-185-21-07  
21,5 cm / 8 4/8"



Mayo-Stillé  
11-184-16-07 -  
11-185-21-07

## Präparierscheren

Dissecting Scissors  
Tijeras de disección  
Ciseaux à dissection  
Forbici per dissezione

## Scheren

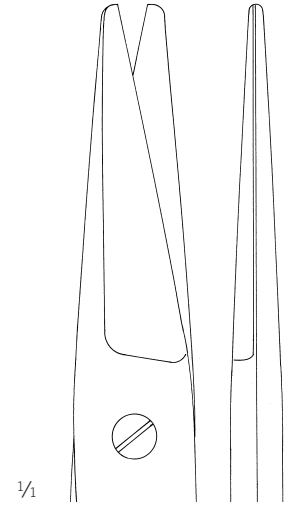
Scissors  
Tijeras  
Ciseaux  
Forbici



11



11-174-22-07  
23 cm / 9"



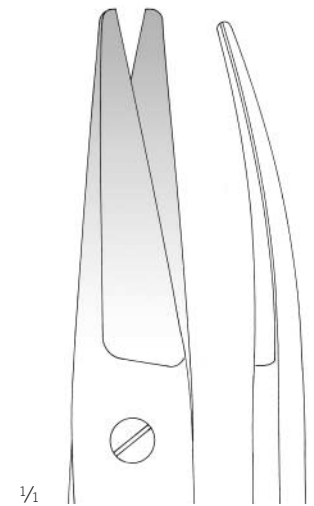
11-190-17-07



11-175-22-07  
23 cm / 9"



11-175-30-07  
28 cm / 11"



11-191-17-07

Mayo-Harrington  
11-174-22-07 -  
11-175-30-07

Mayo-Noble  
11-190-17-07 -  
11-191-17-07  
16,5 cm / 6 5/8"

# Gynäkologische Scheren

Gynecological Scissors

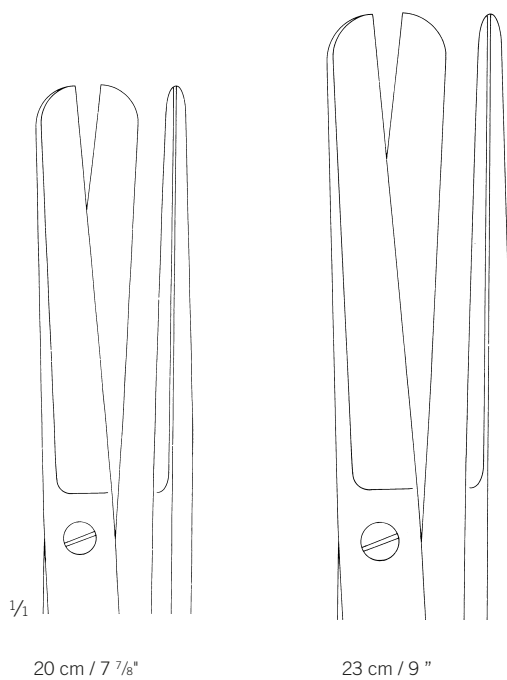
Tijeras para ginecología

Ciseaux à gynécologie

Forbici per ginecologia



| Sims           | Standard     | TCGOLD       |
|----------------|--------------|--------------|
| 20 cm / 7 7/8" | 11-200-20-07 |              |
| 23 cm / 9"     | 11-200-23-07 | 11-976-23-07 |



# Gynäkologische Scheren

Gynecological Scissors  
Tijeras para ginecología  
Ciseaux à gynécologie  
Forbici per ginecologia

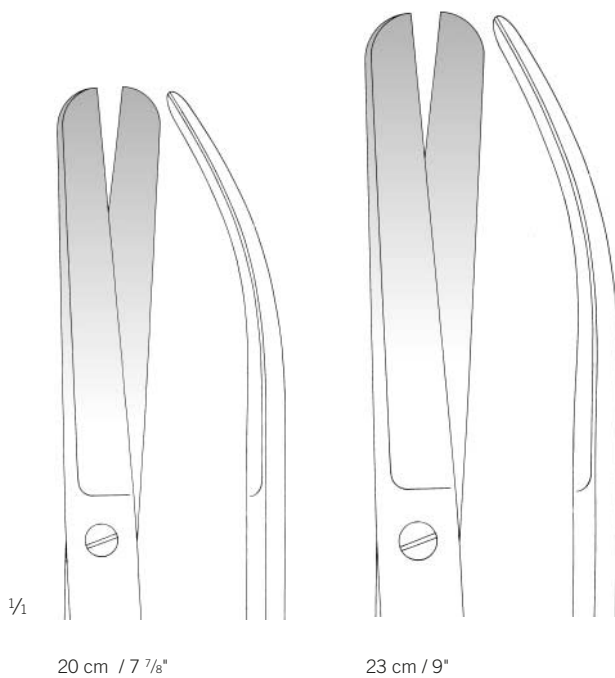
# Scheren

Scissors  
Tijeras  
Ciseaux  
Forbici



11

| Sims           | Standard     | TCGOLD       | AQUILA       | TCCBlackLine |
|----------------|--------------|--------------|--------------|--------------|
| 20 cm / 7 7/8" | 11-203-20-07 |              | 11-975-20-07 | 11-925-20-07 |
| 23 cm / 9"     | 11-203-23-07 | 11-977-23-07 | 11-975-23-07 | 11-925-23-07 |



# Chirurgische Scheren

Operating Scissors

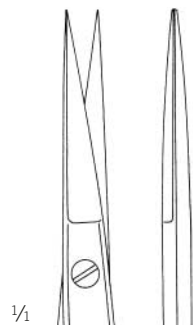
Tijeras quirúrgicas

Ciseaux chirurgicaux

Forbici per chirurgia



| Kelly          | Standard     | TC GOLD      | SuperCut     | ST           | AQUILA       |
|----------------|--------------|--------------|--------------|--------------|--------------|
| 16 cm / 6 2/8" | 11-226-16-07 | 11-992-16-07 | 11-656-16-07 | 28-434-16-07 | 28-474-16-07 |



16 cm / 6 2/8"

# Chirurgische Scheren

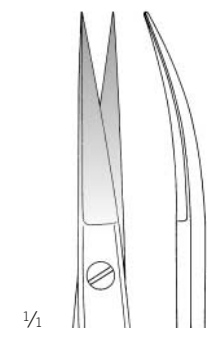
Operating Scissors  
Tijeras quirúrgicas  
Ciseaux chirurgicaux  
Forbici per chirurgia

# Scheren

Scissors  
Tijeras  
Ciseaux  
Forbici



| Kelly          | Standard     | TC GOLD      | SuperCut     | ST           | AQUILA       |
|----------------|--------------|--------------|--------------|--------------|--------------|
| 16 cm / 6 2/8" | 11-227-16-07 | 11-993-16-07 | 11-657-16-07 | 28-435-16-07 | 28-475-16-07 |



16 cm / 6 2/8"

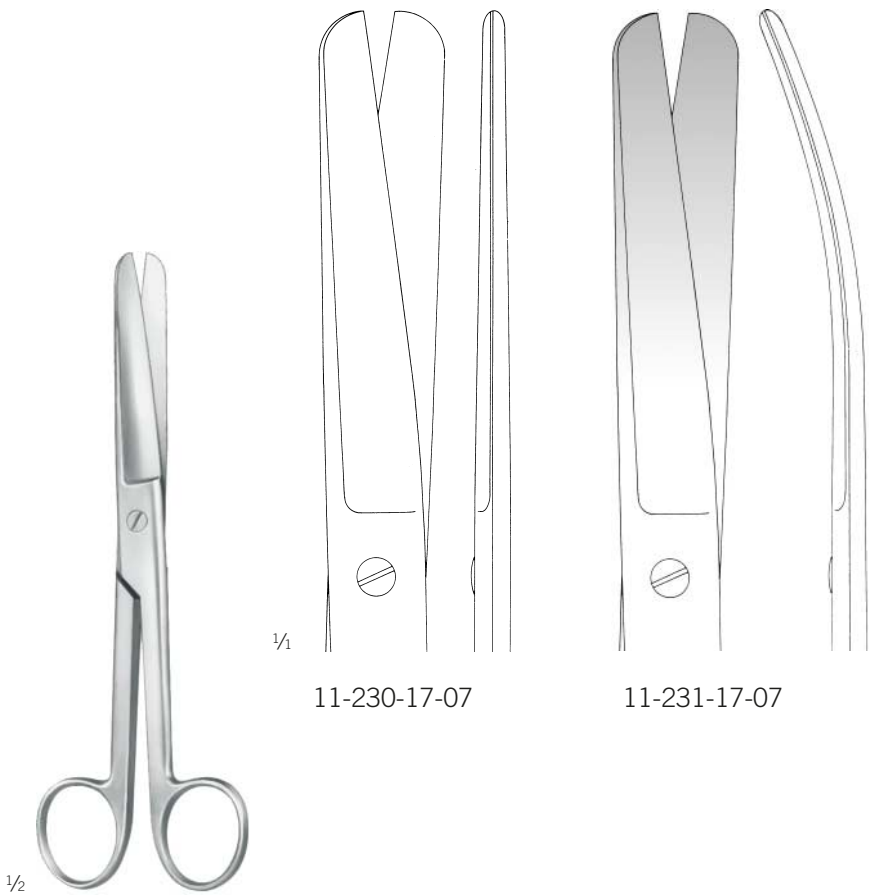
## Gynäkologische Scheren

Gynecological Scissors

Tijeras para ginecología

Ciseaux à gynécologie

Forbici per ginecologia



Doyen  
11-230-17-07 -  
11-231-17-07  
18,5 cm / 7 2/8"

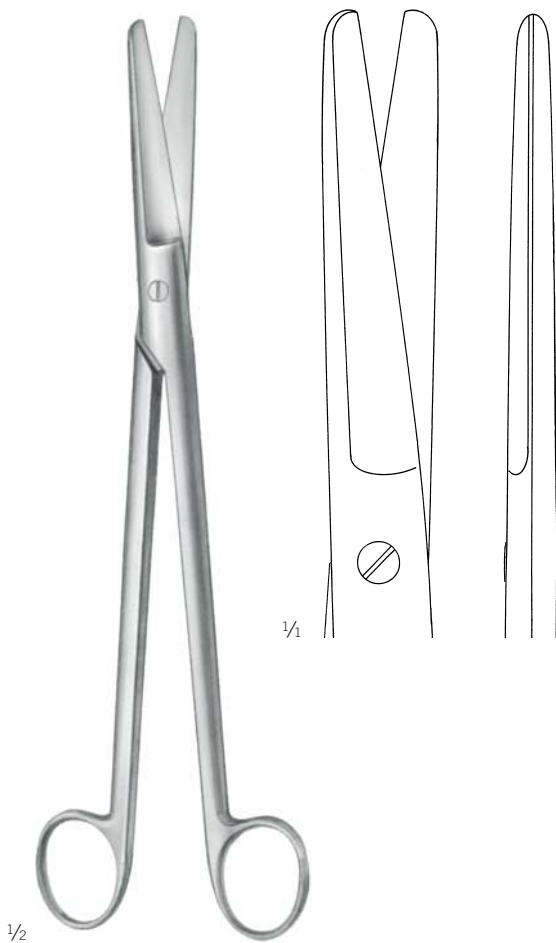


## Gynäkologische Scheren

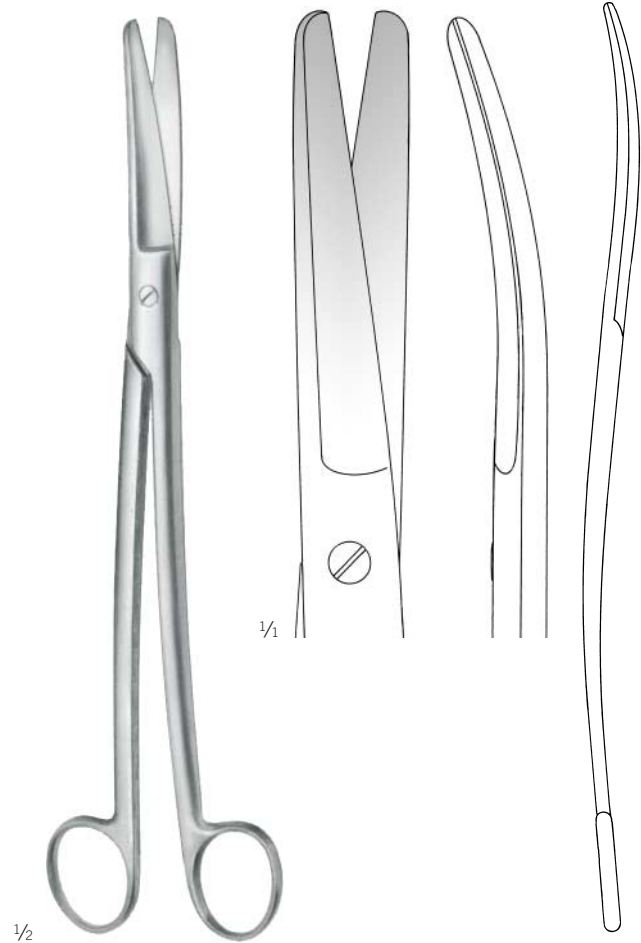
Gynecological Scissors  
Tijeras para ginecología  
Ciseaux à gynécologie  
Forbici per ginecologia

## Scheren

Scissors  
Tijeras  
Ciseaux  
Forbici



Sims-Siebold  
11-232-24-07  
24,5 cm / 9 5/8"



Sims-Siebold  
11-233-24-07  
24,5 cm / 9 5/8"

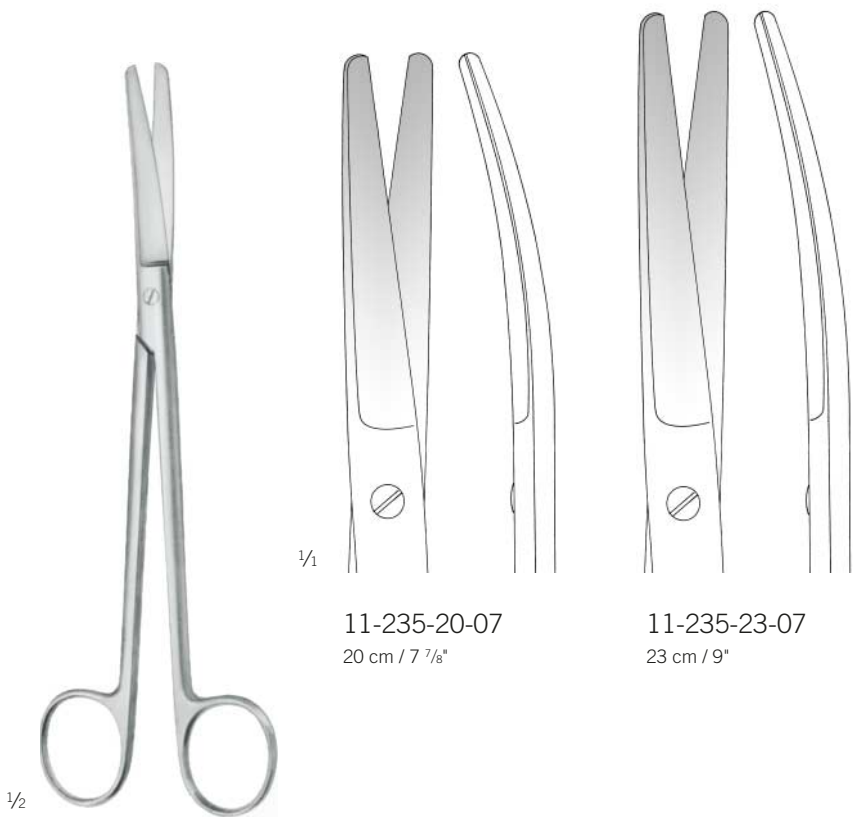
## Gynäkologische Scheren

Gynecological Scissors

Tijeras para ginecología

Ciseaux à gynécologie

Forbici per ginecologia



Wertheim  
11-235-20-07 -  
11-235-23-07

## Präparierscheren

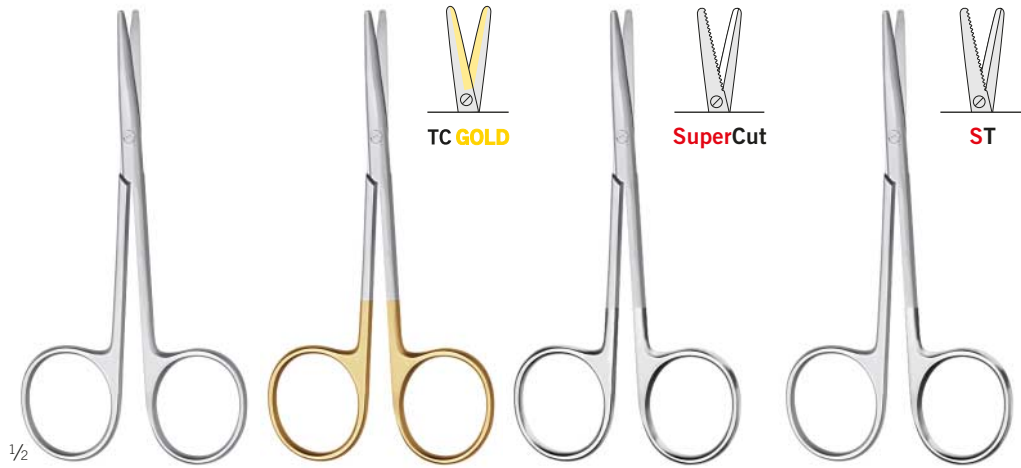
Dissecting Scissors  
Tijeras de disección  
Ciseaux à dissection  
Forbici per dissezione

## Scheren

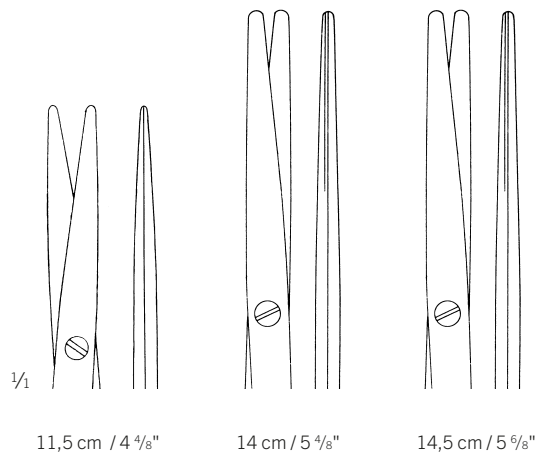
Scissors  
Tijeras  
Ciseaux  
Forbici



11



| Metzenbaum       | Standard     | TC GOLD      | SuperCut     | ST           |
|------------------|--------------|--------------|--------------|--------------|
| 11,5 cm / 4 1/8" | 11-248-11-07 | 11-936-11-07 | 11-658-11-07 | 28-424-11-07 |
| 14 cm / 5 1/8"   |              |              |              | 28-424-14-07 |
| 14,5 cm / 5 7/8" | 11-250-14-07 | 11-938-14-07 | 11-658-14-07 |              |

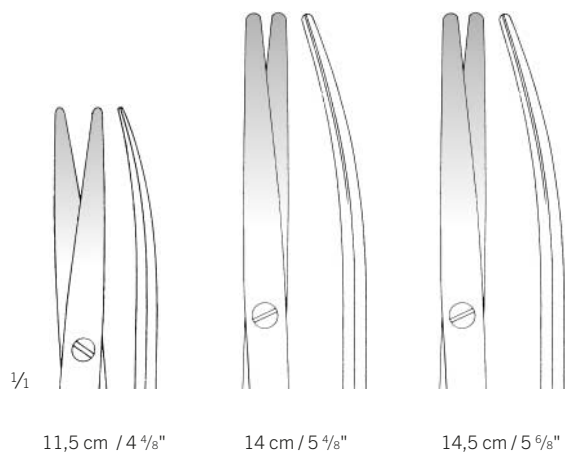


## Präparierscheren

Dissecting Scissors  
Tijeras de disección  
Ciseaux à dissection  
Forbici per dissezione



| Metzenbaum       | Standard     | TC GOLD      | SuperCut     | ST           |
|------------------|--------------|--------------|--------------|--------------|
| 11,5 cm / 4 1/8" | 11-249-11-07 | 11-937-11-07 | 11-659-11-07 | 28-425-11-07 |
| 14 cm / 5 1/8"   |              |              |              | 28-425-14-07 |
| 14,5 cm / 5 6/8" | 11-255-14-07 | 11-939-14-07 | 11-659-14-07 |              |



## Präparierscheren

Dissecting Scissors  
Tijeras de disección  
Ciseaux à dissection  
Forbici per dissezione

## Scheren

Scissors  
Tijeras  
Ciseaux  
Forbici



11



| Metzenbaum     |  AQUILA | TCCBlackLine |
|----------------|--|--------------|
| 12 cm / 4 5/8" | 11-887-11-07   | 11-917-11-07 |



12 cm / 4 5/8"

# Präparierscheren

Dissecting Scissors

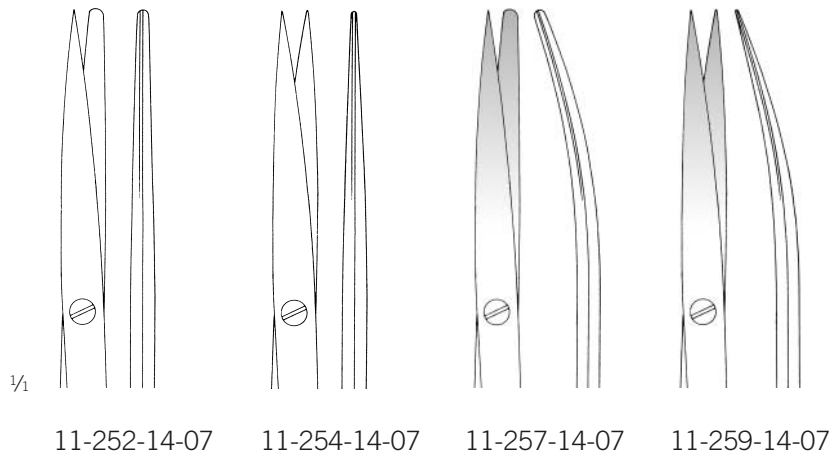
Tijeras de disección

Ciseaux à dissection

Forbici per dissezione

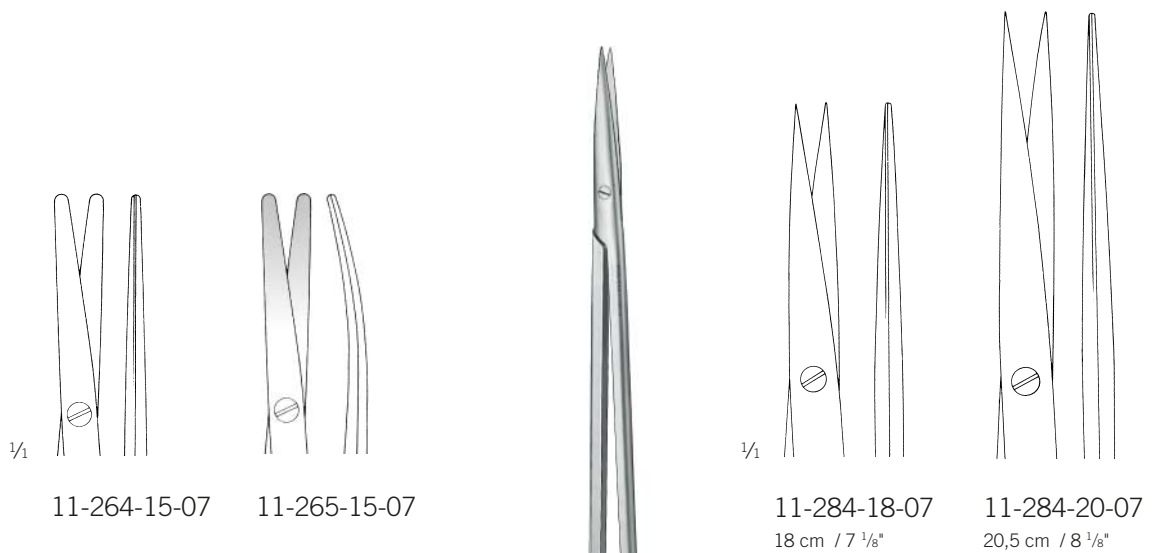


Metzenbaum  
11-252-14-07 -  
11-259-14-07  
14,5 cm / 5 7/8"



1/2

Metzenbaum  
11-264-15-07 -  
11-265-15-07  
15,5 cm / 6 1/8"



1/2

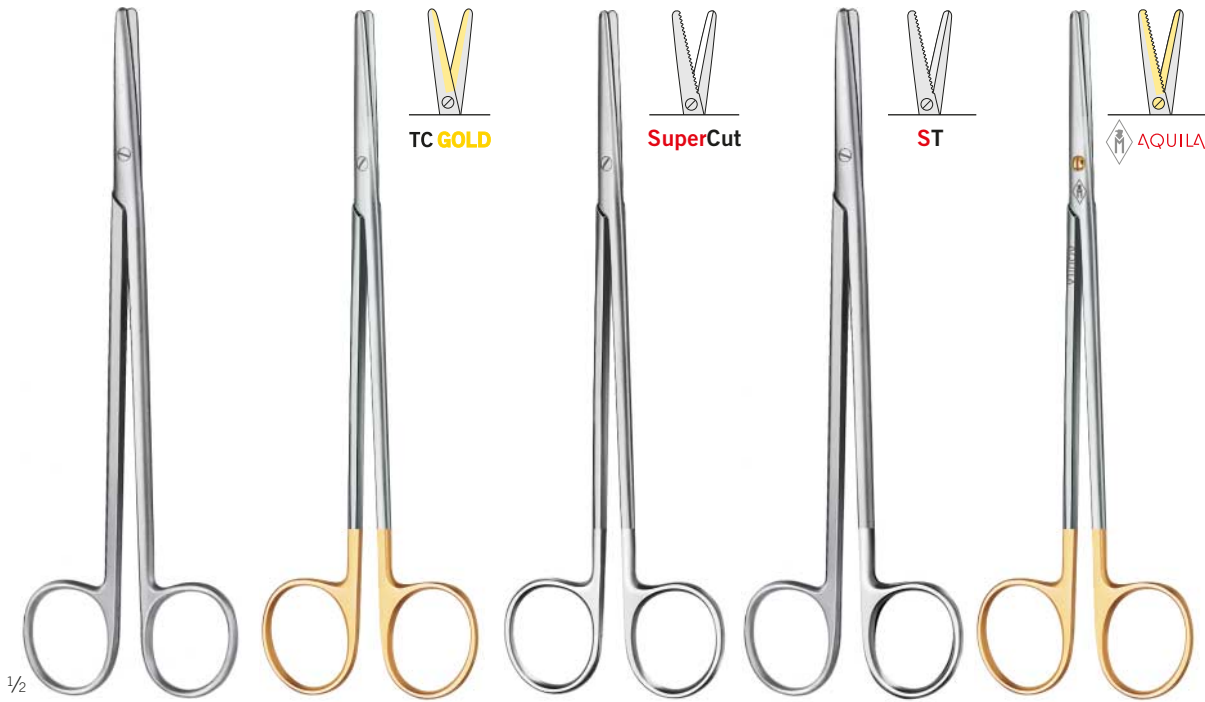
Metzenbaum-Nelson  
11-284-18-07 -  
11-284-20-07

# Präparierscheren

Dissecting Scissors  
Tijeras de disección  
Ciseaux à dissection  
Forbici per dissezione

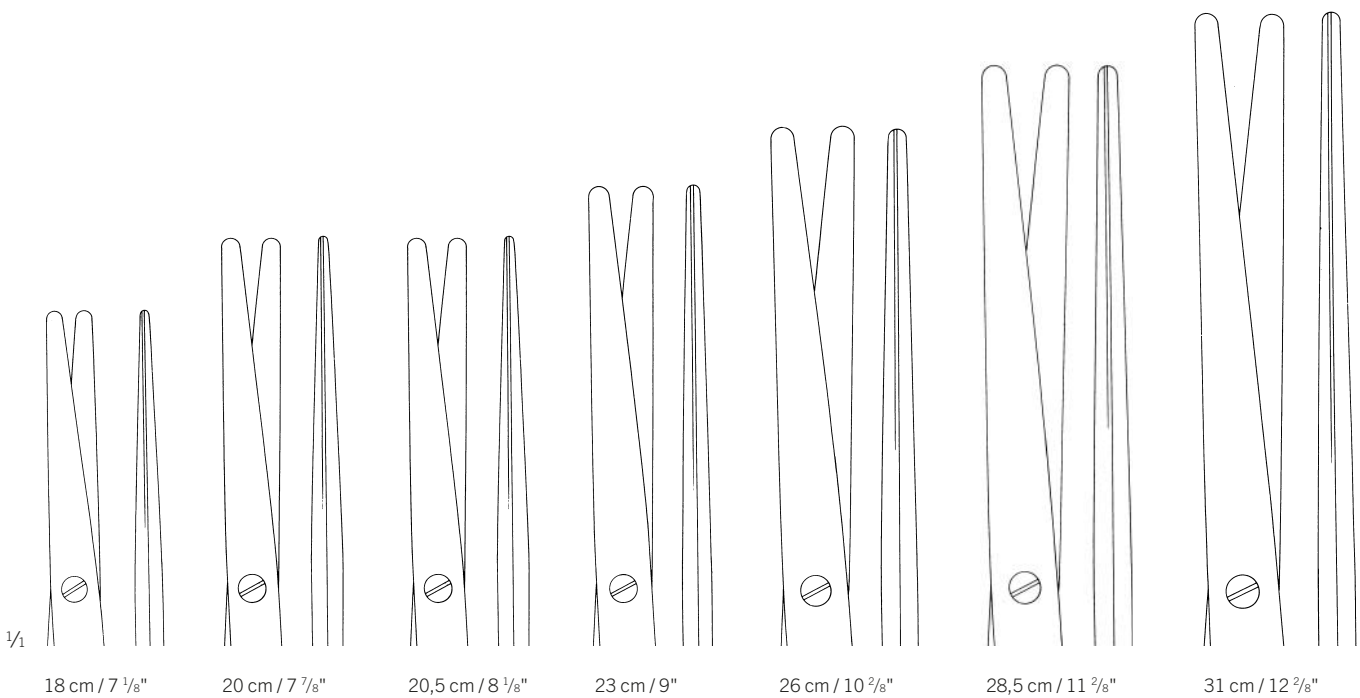
# Scheren

Scissors  
Tijeras  
Ciseaux  
Forbici



11

| Metzenbaum        | Standard     | TC GOLD      | SuperCut     | ST           | AQUILA       |
|-------------------|--------------|--------------|--------------|--------------|--------------|
| 18 cm / 7 1/8"    | 11-280-18-07 | 11-942-18-07 | 11-660-18-07 | 28-424-18-07 |              |
| 20 cm / 7 7/8"    |              |              |              |              | 28-472-20-07 |
| 20,5 cm / 8 1/8"  | 11-280-20-07 | 11-942-20-07 | 11-660-20-07 | 28-424-20-07 |              |
| 23 cm / 9"        | 11-280-23-07 | 11-942-23-07 | 11-660-23-07 | 28-426-23-07 | 28-472-23-07 |
| 26 cm / 10 2/8"   | 11-280-25-07 | 11-942-25-07 | 11-660-26-07 | 28-426-26-07 |              |
| 28,5 cm / 11 2/8" | 11-280-28-07 | 11-942-28-07 | 11-660-28-07 |              |              |
| 31 cm / 12 2/8"   | 11-280-30-07 | 11-942-30-07 | 11-660-31-07 | 28-426-30-07 |              |

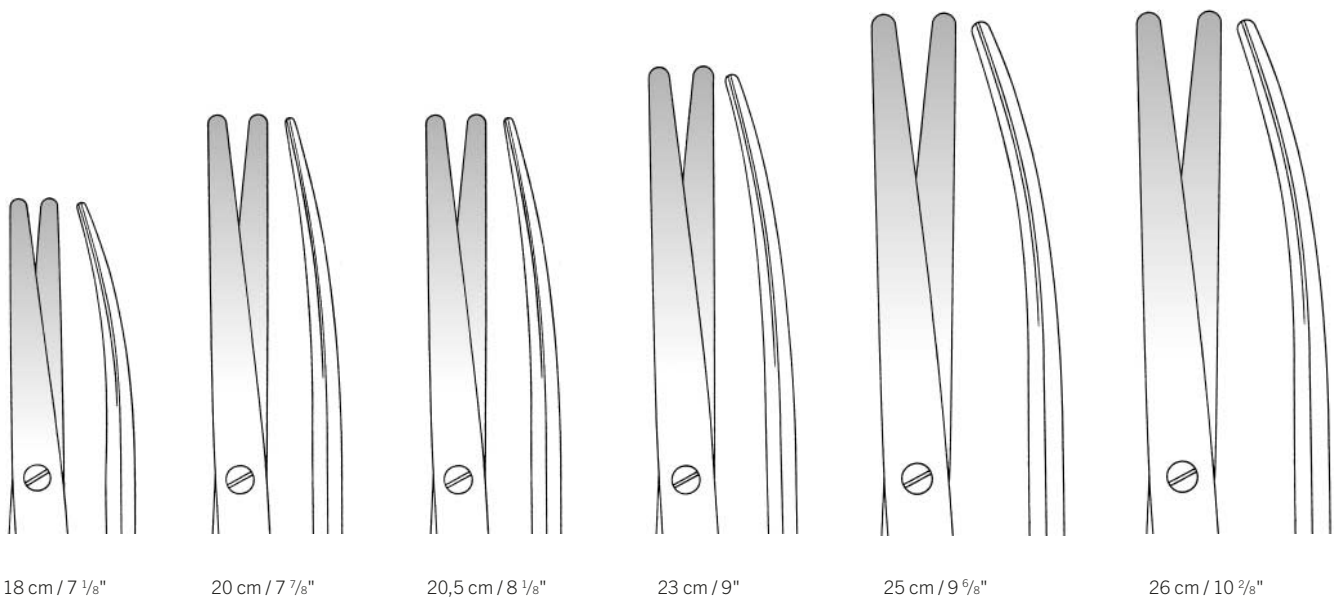


# Präparierscheren

Dissecting Scissors  
 Tijeras de disección  
 Ciseaux à dissection  
 Forbici per dissezione



| Metzenbaum        | Standard     | TC GOLD      | SuperCut     | ST           |
|-------------------|--------------|--------------|--------------|--------------|
| 18 cm / 7 1/8"    | 11-285-18-07 | 11-943-18-07 | 11-661-18-07 | 28-425-18-07 |
| 20 cm / 7 7/8"    |              |              |              | 28-425-20-07 |
| 20,5 cm / 8 1/8"  | 11-285-20-07 | 11-943-20-07 | 11-661-20-07 |              |
| 23 cm / 9"        | 11-285-23-07 | 11-943-23-07 | 11-661-23-07 | 28-427-23-07 |
| 25 cm / 9 5/8"    |              |              |              |              |
| 26 cm / 10 2/8"   | 11-285-25-07 | 11-943-25-07 | 11-661-26-07 | 28-427-26-07 |
| 28,5 cm / 11 2/8" | 11-285-28-07 | 11-943-28-07 | 11-661-28-07 |              |
| 30 cm / 11 5/8"   |              | 11-943-30-07 |              | 28-427-30-07 |
| 31 cm / 12 2/8"   | 11-285-30-07 |              | 11-661-31-07 |              |



18 cm / 7 1/8"

20 cm / 7 7/8"

20,5 cm / 8 1/8"

23 cm / 9"

25 cm / 9 5/8"

26 cm / 10 2/8"



## Präparierscheren

Dissecting Scissors  
Tijeras de disección  
Ciseaux à dissection  
Forbici per dissezione

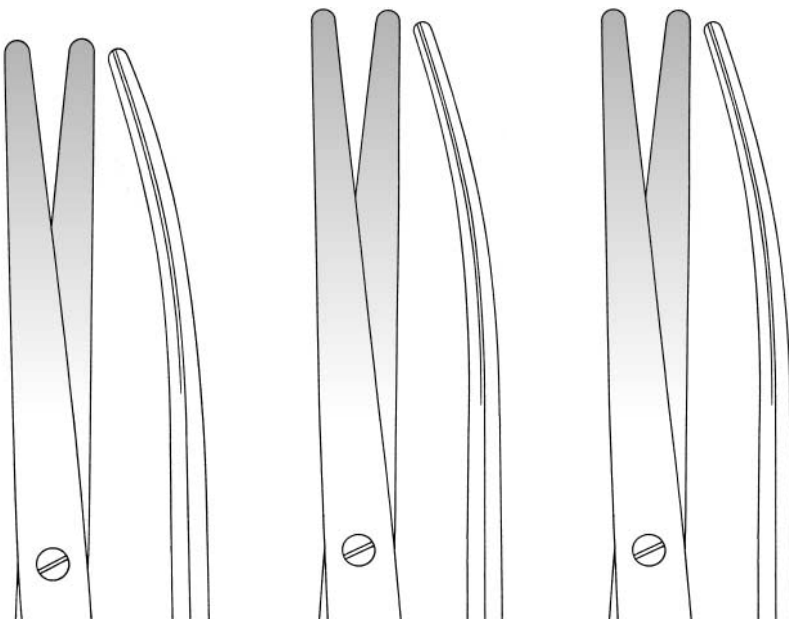
## Scheren

Scissors  
Tijeras  
Ciseaux  
Forbici



11

| Metzenbaum        | AQUILA       | TCCBlackLine |
|-------------------|--------------|--------------|
| 18 cm / 7 1/8"    | 11-887-18-07 | 11-917-18-07 |
| 20 cm / 7 7/8"    |              |              |
| 20,5 cm / 8 1/8"  | 11-887-20-07 | 11-917-20-07 |
| 23 cm / 9"        | 11-887-23-07 | 11-917-23-07 |
| 25 cm / 9 6/8"    | 11-887-25-07 | 11-917-25-07 |
| 26 cm / 10 2/8"   |              |              |
| 28,5 cm / 11 2/8" |              |              |
| 30 cm / 11 6/8"   | 11-887-30-07 | 11-917-30-07 |
| 31 cm / 12 2/8"   |              |              |



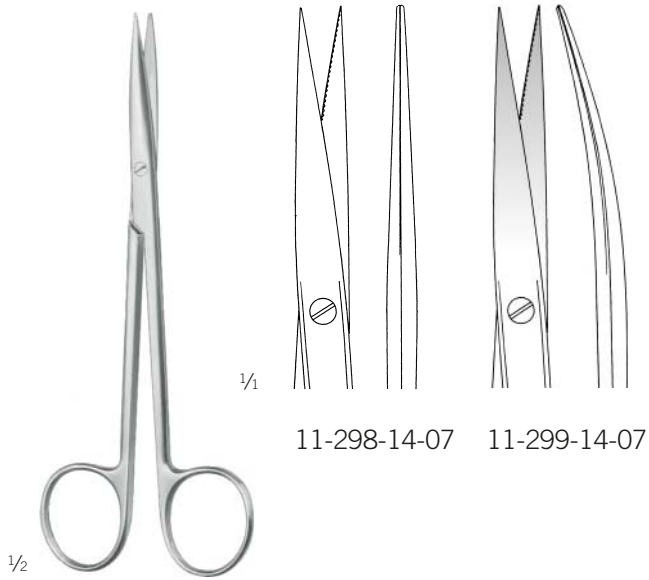
28,5 cm / 11 2/8"

30 cm / 11 6/8"

31 cm / 12 1/8"

## Präparierscheren

Dissecting Scissors  
Tijeras de disección  
Ciseaux à dissection  
Forbici per dissezione



Metzenbaum  
11-298-14-07-  
11-299-14-07

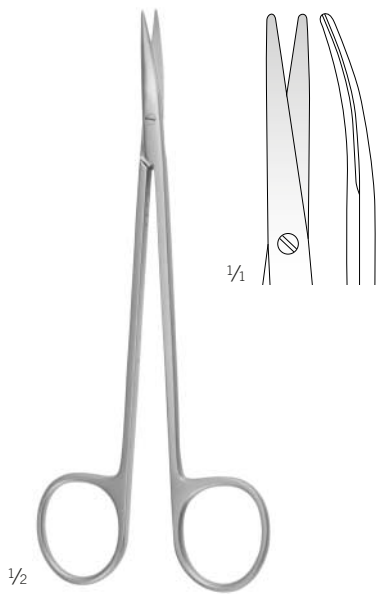
14,5 cm / 5 5/8"

eine Schneide gezahnt  
one toothed cutting edge  
una hoja dentada  
une lame dentelée  
una lama dentata



11-300-15-07 -  
11-301-15-07

15,5 cm / 6 1/8"



Kübler  
11-302-15-07

15 cm / 5 7/8"



Kaye  
11-305-00-07

18,5 cm / 7 2/8"

beide Schneiden gezahnt  
both cutting edges serrated  
ambos filos dentados  
deux lames dentées  
entrambe le lame dentate

## Präparierscheren

Dissecting Scissors  
Tijeras de disección  
Ciseaux à dissection  
Forbici per dissezione

## Scheren

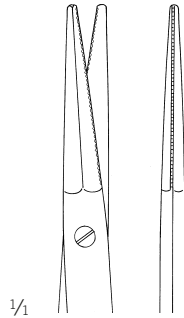
Scissors  
Tijeras  
Ciseaux  
Forbici



11

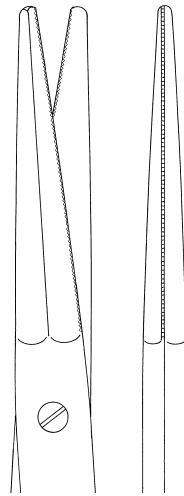


1/2

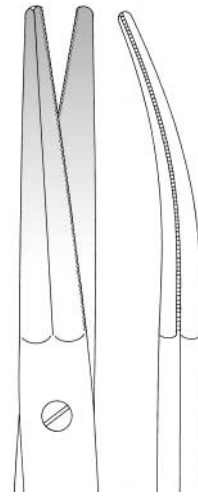


1/1

11-306-12-07  
12,5 cm / 4 7/8"



11-306-19-07  
19,5 cm / 7 5/8"



11-307-19-07  
19,5 cm / 7 5/8"

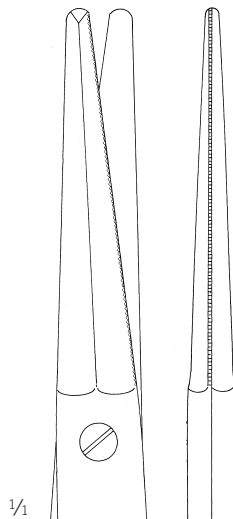
Gorney

11-306-12-07 -  
11-307-19-07

beide Schneiden gezahnt  
both cutting edges serrated  
ambos filos dentados  
deux lames dentées  
entrambe le lame dentate



1/2



1/1

Aston

11-308-17-07

17 cm / 6 5/8"

eine Schneide gezahnt  
one toothed cutting edge  
una hoja dentada  
une lame dentée  
una lama dentata

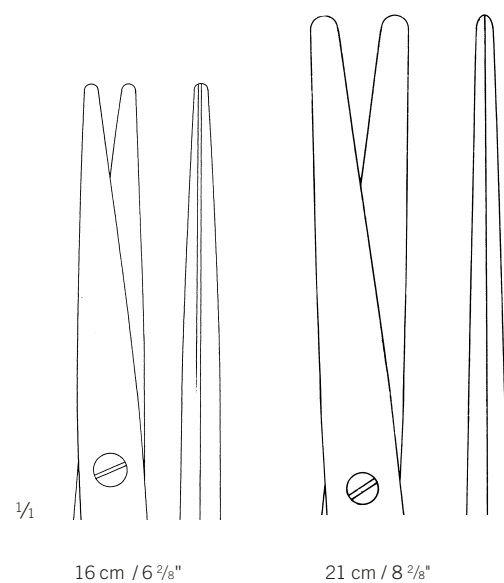
# Präparierscheren

Dissecting Scissors  
 Tijeras de disección  
 Ciseaux à dissection  
 Forbici per dissezione



1/2

| Lexer          | Standard     | TC GOLD      | SuperCut     | ST           | AQUILA       |
|----------------|--------------|--------------|--------------|--------------|--------------|
| 16 cm / 6 2/8" | 11-310-16-07 | 11-950-16-07 | 11-662-16-07 | 28-410-16-07 | 28-468-16-07 |
| 21 cm / 8 2/8" |              | 11-950-21-07 |              |              |              |



1/1

16 cm / 6 2/8"

21 cm / 8 2/8"

## Präparierscheren

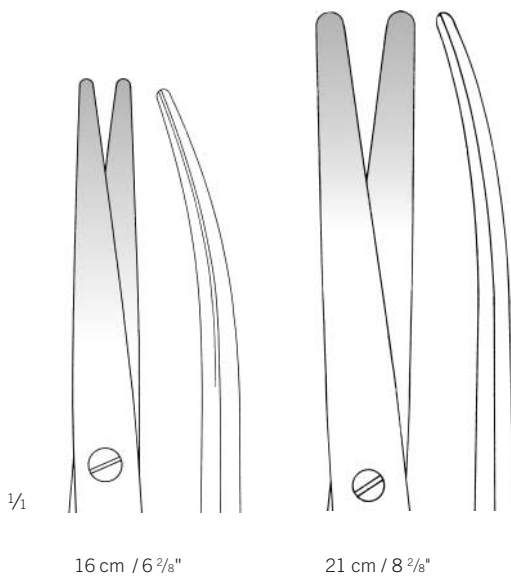
Dissecting Scissors  
Tijeras de disección  
Ciseaux à dissection  
Forbici per dissezione

## Scheren

Scissors  
Tijeras  
Ciseaux  
Forbici



| Lexer          | Standard     | TC GOLD      | SuperCut     | ST           | AQUILA       |
|----------------|--------------|--------------|--------------|--------------|--------------|
| 16 cm / 6 2/8" | 11-311-16-07 | 11-951-16-07 | 11-663-16-07 | 28-411-16-07 | 28-469-16-07 |
| 21 cm / 8 2/8" |              | 11-951-21-07 |              |              |              |



16 cm / 6 2/8"

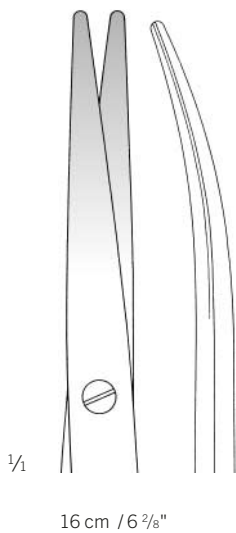
21 cm / 8 2/8"

## Präparierscheren

Dissecting Scissors  
Tijeras de disección  
Ciseaux à dissection  
Forbici per dissezione



| Lexer          | AQUILA       | TCCBlackLine |
|----------------|--------------|--------------|
| 16 cm / 6 2/8" | 11-895-16-07 | 11-923-16-07 |



## Präparierscheren

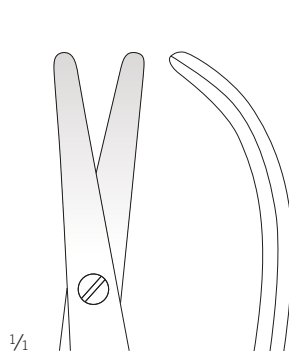
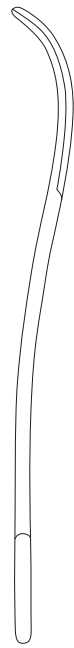
Dissecting Scissors  
Tijeras de disección  
Ciseaux à dissection  
Forbici per dissezione

## Scheren

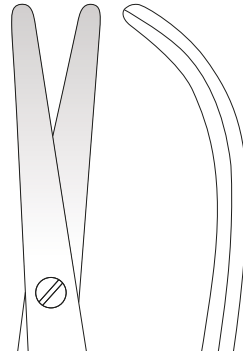
Scissors  
Tijeras  
Ciseaux  
Forbici



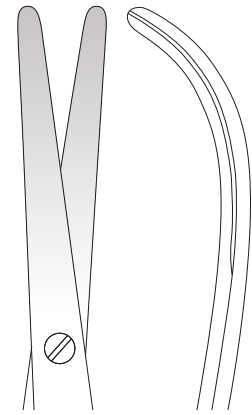
Hohenfellner  
11-314-18-07 -  
11-314-24-07



11-314-18-07  
18 cm / 7 1/8"



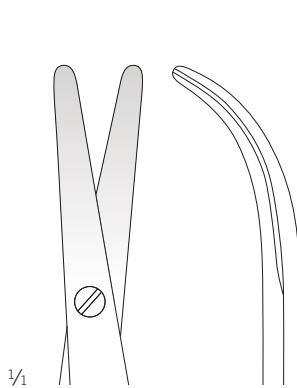
11-314-21-07  
21 cm / 8 2/8"



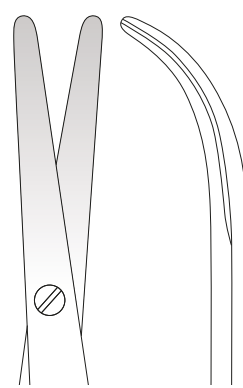
11-314-24-07  
24 cm / 9 4/8"



DeBakey  
11-316-17-07 -  
11-316-20-07



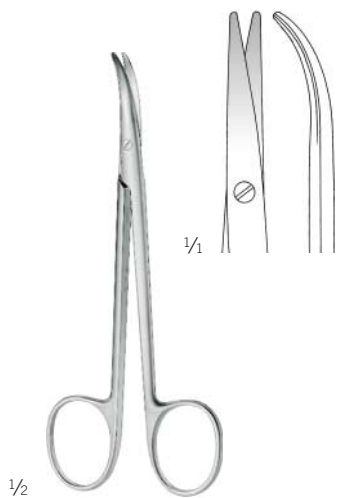
11-316-17-07  
17,5 cm / 6 7/8"



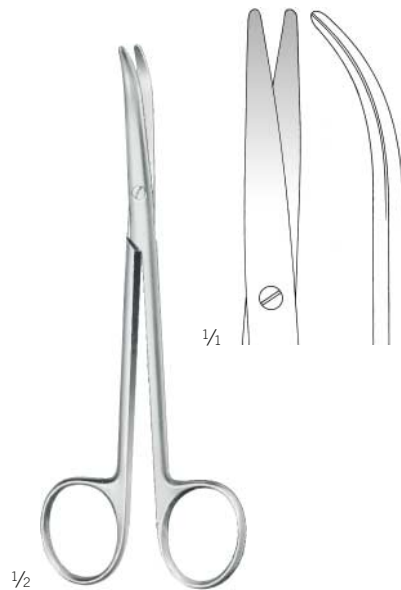
11-316-20-07  
20 cm / 7 7/8"

## Präparierscheren

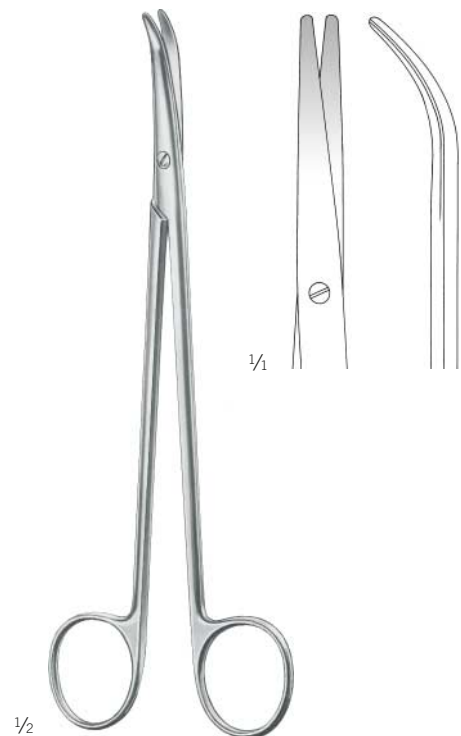
Dissecting Scissors  
Tijeras de disección  
Ciseaux à dissection  
Forbici per dissezione



Cinelli  
11-317-11-07  
11,5 cm / 4 1/8"



Fomon  
11-317-14-07  
14 cm / 5 4/8"



Thorek  
11-319-19-07  
18,5 cm / 7 3/8"



## Präparierscheren

Dissecting Scissors  
Tijeras de disección  
Ciseaux à dissection  
Forbici per dissezione

## Scheren

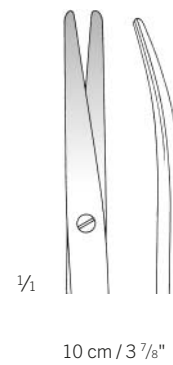
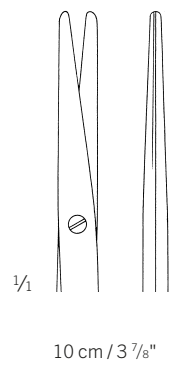
Scissors  
Tijeras  
Ciseaux  
Forbici



| Lexer-Baby     | Standard     | SuperCut     |
|----------------|--------------|--------------|
| 10 cm / 3 7/8" | 11-320-10-07 | 11-662-10-07 |



| Standard     | SuperCut     |
|--------------|--------------|
| 11-321-10-07 | 11-663-10-07 |



## Präparierscheren

Dissecting Scissors  
Tijeras de disección  
Ciseaux à dissection  
Forbici per dissezione

**fino**Line



Lexer-Fino  
11-324-16-07 -  
11-325-16-07

16,5 cm / 6 4/8"  
schlankes Modell  
slender pattern  
modelo delgado  
modèle gracile  
modello delicato

## Feine Präparierscheren

Delicate Dissecting Scissors

Tijeras finas de disección

Ciseaux fins à dissection

Forbici fini per dissezione

## Scheren

Scissors

Tijeras

Ciseaux

Forbici



### finoLine

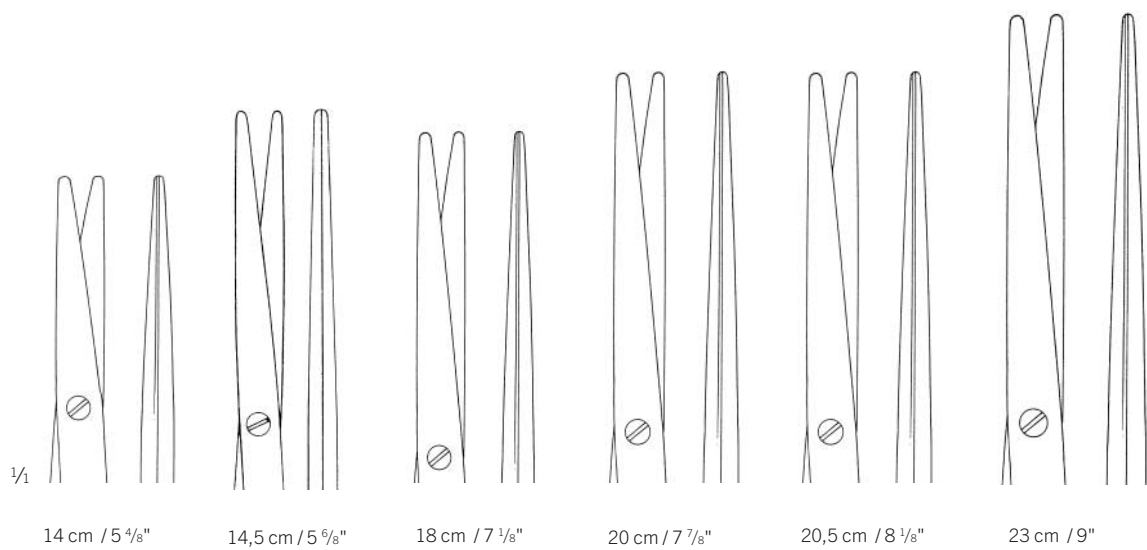


1/2

TC GOLD

ST

| Metzenbaum       | Standard     | TC GOLD      | ST           |
|------------------|--------------|--------------|--------------|
| 14 cm / 5 1/8"   |              |              | 28-428-14-07 |
| 14,5 cm / 5 9/8" | 11-326-14-07 | 11-954-14-07 |              |
| 18 cm / 7 1/8"   | 11-330-18-07 | 11-960-18-07 | 28-428-18-07 |
| 20 cm / 7 7/8"   |              |              | 28-428-20-07 |
| 20,5 cm / 8 1/8" | 11-330-20-07 |              |              |
| 23 cm / 9"       | 11-330-23-07 |              | 28-428-23-07 |



1/1

14 cm / 5 1/8"

14,5 cm / 5 9/8"

18 cm / 7 1/8"

20 cm / 7 7/8"

20,5 cm / 8 1/8"

23 cm / 9"

## Feine Präparierscheren

Delicate Dissecting Scissors

Tijeras finas de disección

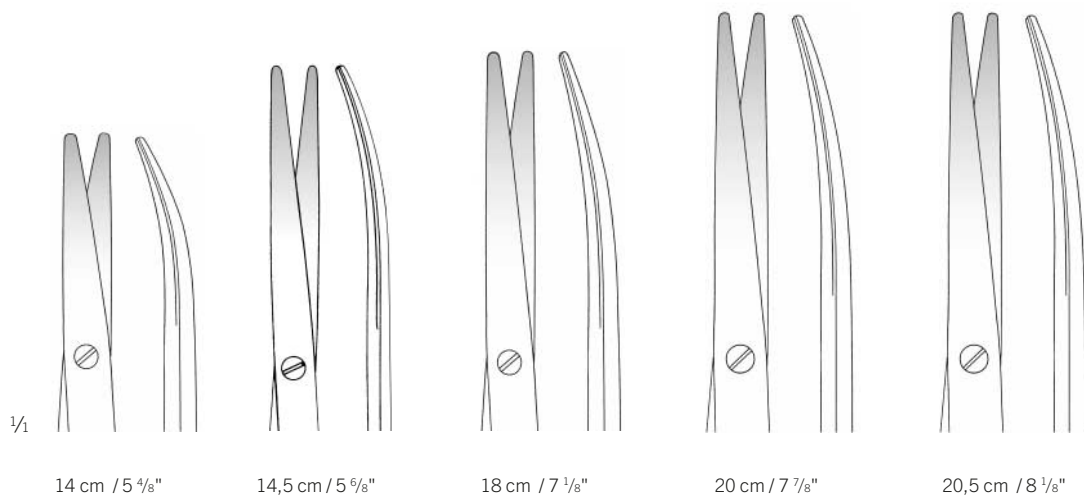
Ciseaux fins à dissection

Forbici fini per dissezione

### finoLine



| Metzenbaum-Fino   | Standard     | TCGOLD       | SuperCut     |
|-------------------|--------------|--------------|--------------|
| 14 cm / 5 4/8"    |              |              |              |
| 14,5 cm / 5 6/8"  | 11-327-14-07 | 11-955-14-07 | 11-665-14-07 |
| 18 cm / 7 1/8"    | 11-331-18-07 | 11-961-18-07 | 11-665-18-07 |
| 20 cm / 7 7/8"    |              |              |              |
| 20,5 cm / 8 1/8"  | 11-331-20-07 | 11-961-20-07 | 11-665-20-07 |
| 23 cm / 9"        | 11-331-23-07 | 11-961-23-07 | 11-665-23-07 |
| 26 cm / 10 2/8"   |              | 11-961-25-07 |              |
| 28,5 cm / 11 2/8" |              | 11-961-28-07 |              |



## Feine Präparierscheren

Delicate Dissecting Scissors

Tijeras finas de disección

Ciseaux fins à dissection

Forbici fini per dissezione

## Scheren

Scissors

Tijeras

Ciseaux

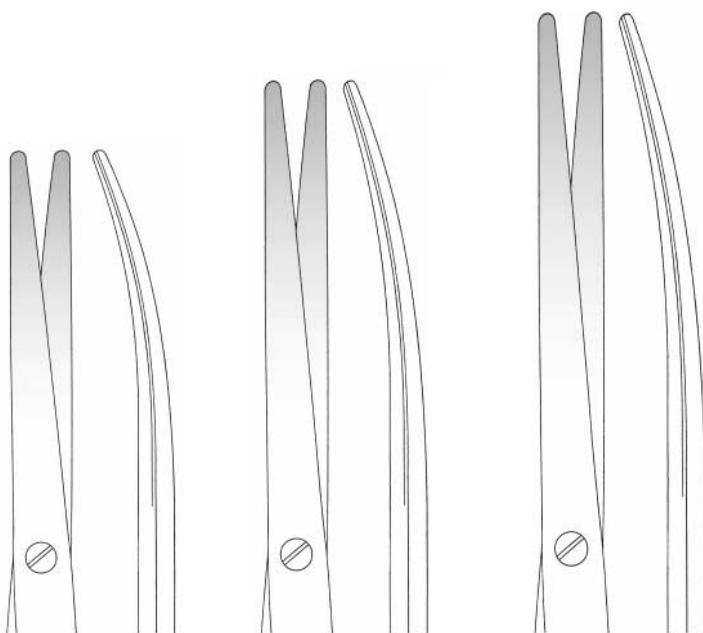
Forbici



### finoLine



| Metzenbaum-Fino   | ST           | AQUILA       |
|-------------------|--------------|--------------|
| 14 cm / 5 1/8"    | 28-429-14-07 |              |
| 14,5 cm / 5 7/8"  |              | 11-889-14-07 |
| 18 cm / 7 1/8"    | 28-429-18-07 | 11-889-18-07 |
| 20 cm / 7 7/8"    | 28-429-20-07 |              |
| 20,5 cm / 8 1/8"  |              |              |
| 23 cm / 9"        | 28-429-23-07 |              |
| 26 cm / 10 2/8"   | 28-429-26-07 |              |
| 28,5 cm / 11 2/8" | 28-429-28-07 |              |



23 cm / 9"

26 cm / 10 2/8"

28,5 cm / 11 2/8"

## Feine Präparierscheren

Delicate Dissecting Scissors

Tijeras finas de disección

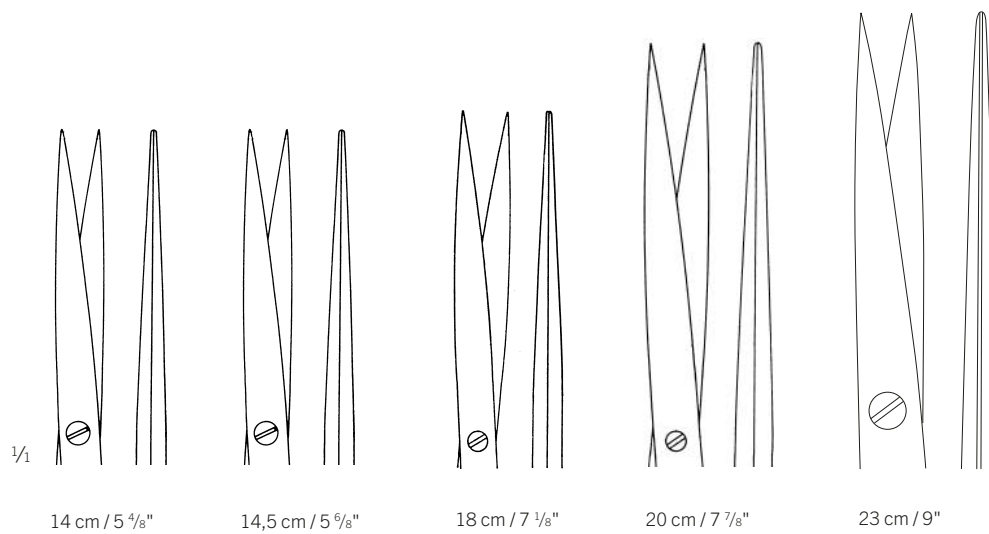
Ciseaux fins à dissection

Forbici fini per dissezione

finoLine



| Metzenbaum-Fino  | Standard     | TC GOLD      | ST           |
|------------------|--------------|--------------|--------------|
| 14 cm / 5 1/8"   |              |              | 28-422-14-07 |
| 14,5 cm / 5 9/8" | 11-328-14-07 | 11-956-14-07 |              |
| 18 cm / 7 1/8"   |              | 11-962-18-07 |              |
| 20 cm / 7 7/8"   |              | 11-962-20-07 |              |
| 23 cm / 9"       |              | 11-962-23-07 |              |



## Feine Präparierscheren

Delicate Dissecting Scissors

Tijeras finas de disección

Ciseaux fins à dissection

Forbici fini per dissezione

## Scheren

Scissors

Tijeras

Ciseaux

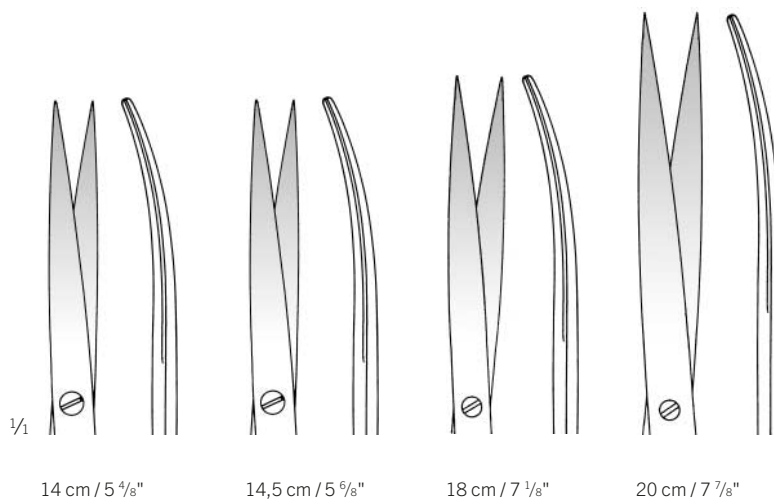
Forbici



### finoLine



| Metzenbaum-Fino  | Standard     | TC GOLD      | ST           |
|------------------|--------------|--------------|--------------|
| 14 cm / 5 4/8"   |              |              | 28-423-14-07 |
| 14,5 cm / 5 6/8" | 11-329-14-07 | 11-957-14-07 |              |
| 18 cm / 7 1/8"   | 11-329-18-07 |              | 28-423-18-07 |
| 20 cm / 7 7/8"   | 11-329-20-07 |              |              |



# Feine Präparierscheren

Delicate Dissecting Scissors

Tijeras finas de disección

Ciseaux fins à dissection

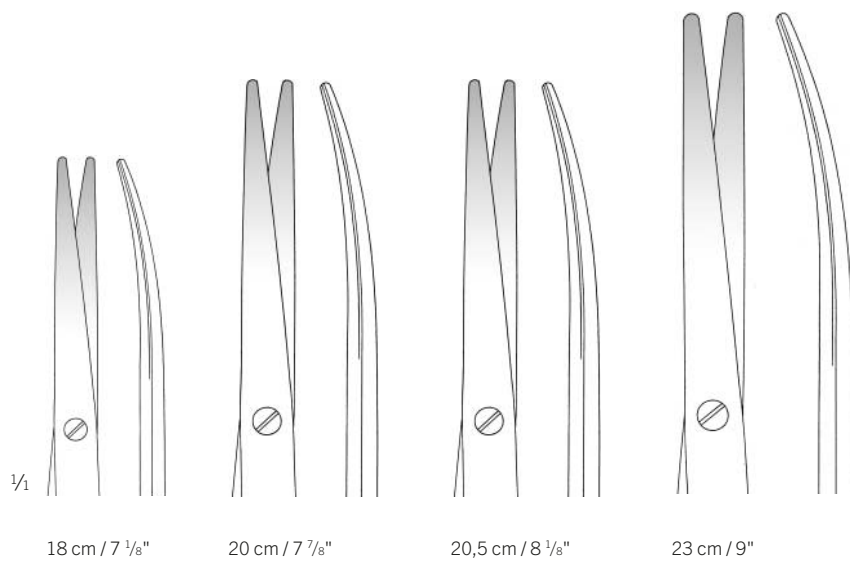
Forbici fini per dissezione

**finoLine**



| Metzenbaum-Fino  | Standard     | TC GOLD      | ST           | AQUILA       |
|------------------|--------------|--------------|--------------|--------------|
| 18 cm / 7 1/8"   | 11-335-18-07 | 11-967-18-07 | 28-431-18-07 | 28-473-18-07 |
| 20 cm / 7 7/8"   |              |              | 28-431-20-07 | 28-473-20-07 |
| 20,5 cm / 8 1/8" | 11-335-20-07 | 11-967-20-07 |              |              |
| 23 cm / 9"       | 11-335-23-07 | 11-967-23-07 | 28-431-23-07 | 28-473-23-07 |

schlankes Modell, S-Form  
slender pattern, S-shaped  
modelo delgado, forma S  
modèle gracile, courbé en S  
modello delicato, curvo in forma S



18 cm / 7 1/8"

20 cm / 7 7/8"

20,5 cm / 8 1/8"

23 cm / 9"



## Präparierscheren, Chirurgische Scheren

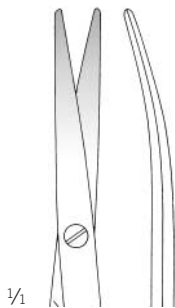
Dissecting Scissors, Operating Scissors  
 Tijeras de disección, Tijeras quirúrgicas  
 Ciseaux à dissection, Ciseaux chirurgicaux  
 Forbici per dissezione, Forbici per chirurgia

## Scheren

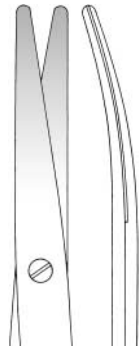
Scissors  
 Tijeras  
 Ciseaux  
 Forbici



11



11-339-12-07  
 12,5 cm / 4 7/8"



11-339-18-07  
 18 cm / 7 1/8"



11-340-14-07



11-341-14-07

Sanvenero  
 11-340-14-07 -  
 11-341-14-07  
 14 cm / 5 4/8"

### Salyer

11-339-12-07 -  
 11-339-18-07

feines Modell, eine Schneide mit Messerschiff  
 delicate pattern, one cutting edge with knife cut  
 modelo delicado, una hoja con afilado de cuchillo  
 modèle fin, une lame avec taille de couteau  
 modello fino, una lama con affilatura di coltello

für Lippen-, Kiefer-, Gaumenspalte  
 for Cleft Palate  
 para fisura paladar  
 pour fente du palais  
 per cheilo-labbro-palato schisi



11-344-11-07



11-345-11-07

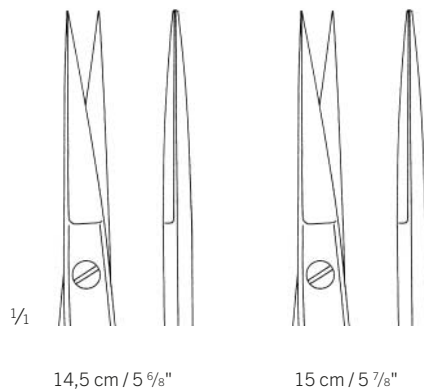
11-344-11-07 -  
 11-345-11-07  
 11 cm / 4 3/8"

# Chirurgische Scheren

Operating Scissors  
 Tijeras quirúrgicas  
 Ciseaux chirurgicaux  
 Forbici per chirurgia



| Joseph           | Standard     | TC GOLD      | SuperCut     | ST           |
|------------------|--------------|--------------|--------------|--------------|
| 14,5 cm / 5 7/8" | 11-350-14-07 | 11-948-14-07 | 11-666-14-07 |              |
| 15 cm / 5 7/8"   |              |              |              | 28-432-15-07 |



# Chirurgische Scheren

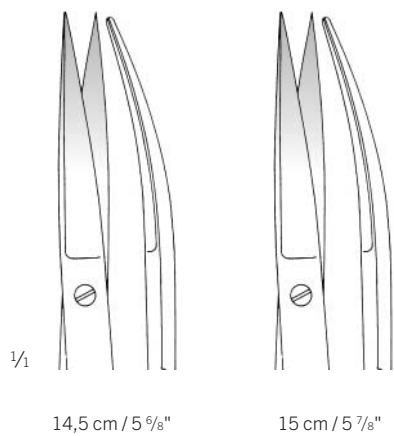
Operating Scissors  
Tijeras quirúrgicas  
Ciseaux chirurgicaux  
Forbici per chirurgia

# Scheren

Scissors  
Tijeras  
Ciseaux  
Forbici



| Joseph           | Standard     | TC GOLD      | SuperCut     | ST           |
|------------------|--------------|--------------|--------------|--------------|
| 14,5 cm / 5 7/8" | 11-351-14-07 | 11-949-14-07 | 11-667-14-07 |              |
| 15 cm / 5 7/8"   |              |              |              | 28-433-15-07 |



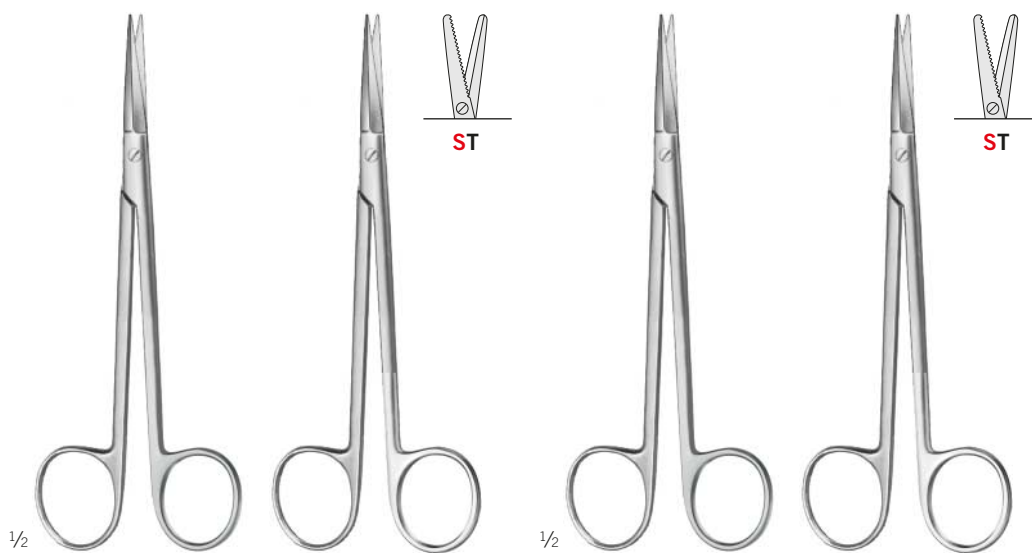
## Face-lift-Scheren

Face-lift Scissors

Tijeras para Face-lift

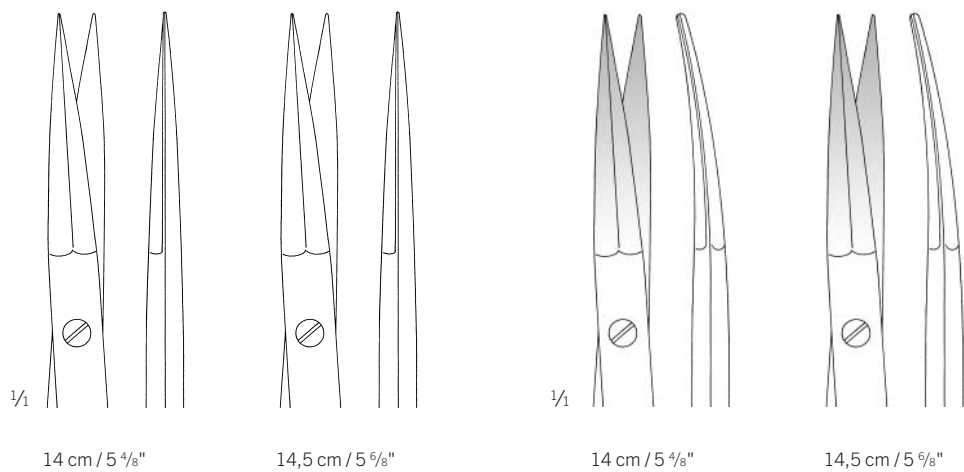
Ciseaux pour Face-lift

Forbici per Face-lift



| Peck-Joseph      | Standard     | ST           |
|------------------|--------------|--------------|
| 14 cm / 5 4/8"   |              | 28-418-14-07 |
| 14,5 cm / 5 6/8" | 11-352-14-07 |              |

| Standard     | ST           |
|--------------|--------------|
|              | 28-419-14-07 |
| 11-353-14-07 |              |



14 cm / 5 4/8"

14,5 cm / 5 6/8"

14 cm / 5 4/8"

14,5 cm / 5 6/8"

## Face-lift-Scheren

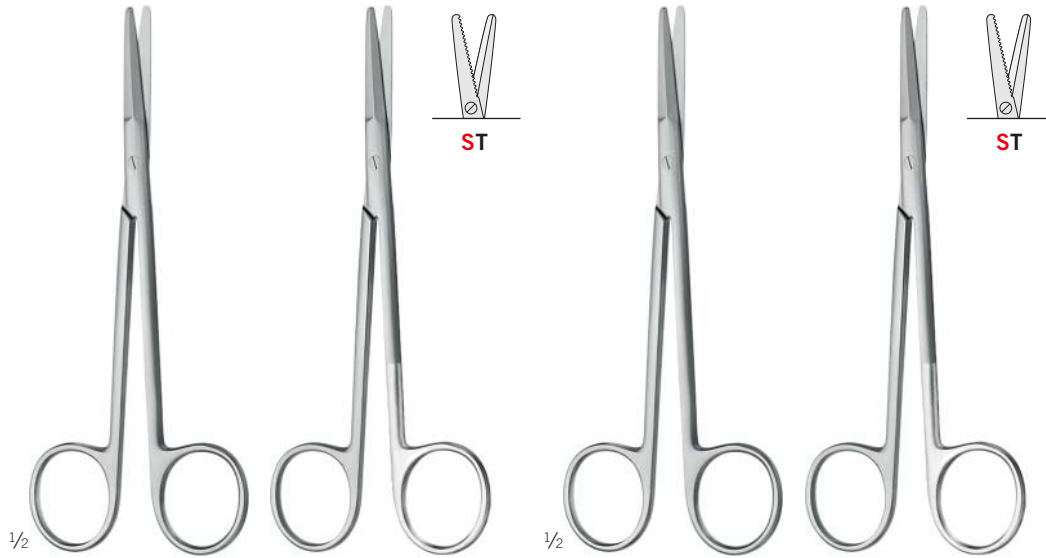
Face-lift Scissors  
Tijeras para Face-lift  
Ciseaux pour Face-lift  
Forbici per Face-lift

## Scheren

Scissors  
Tijeras  
Ciseaux  
Forbici

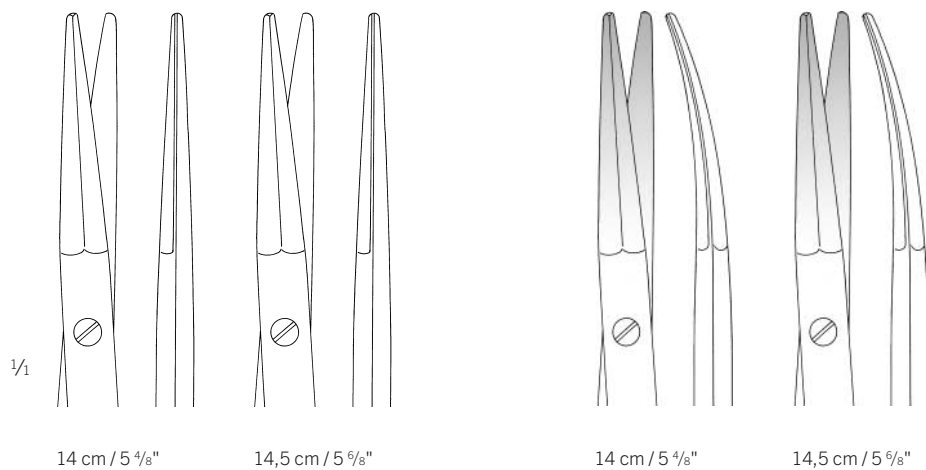


11



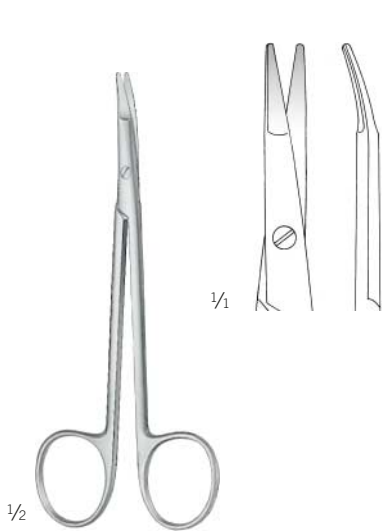
| Peck-Joseph      | Standard     | ST           |
|------------------|--------------|--------------|
| 14 cm / 5 4/8"   |              | 28-420-14-07 |
| 14,5 cm / 5 5/8" | 11-354-14-07 |              |

| Standard     | ST           |
|--------------|--------------|
|              | 28-421-14-07 |
| 11-355-14-07 |              |

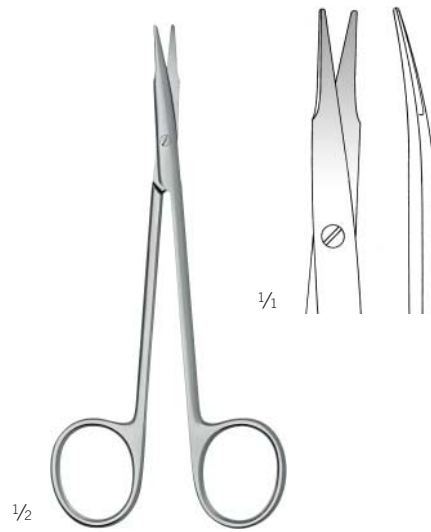


## Dissektions- u. Zahnfleischschere

Dissecting Scissors  
Tijera de disección  
Ciseaux à dissection  
Forbici per dissezione



Shea Vein Graft  
11-357-12-07  
12 cm / 4  $\frac{5}{8}$ "



11-358-13-07  
13 cm / 5  $\frac{1}{8}$ "  
Dissektions- u. Zahnfleischschere  
Dissecting Scissors  
Tijera de disección  
Ciseaux à dissection  
Forbici per dissezione

## Präparierscheren

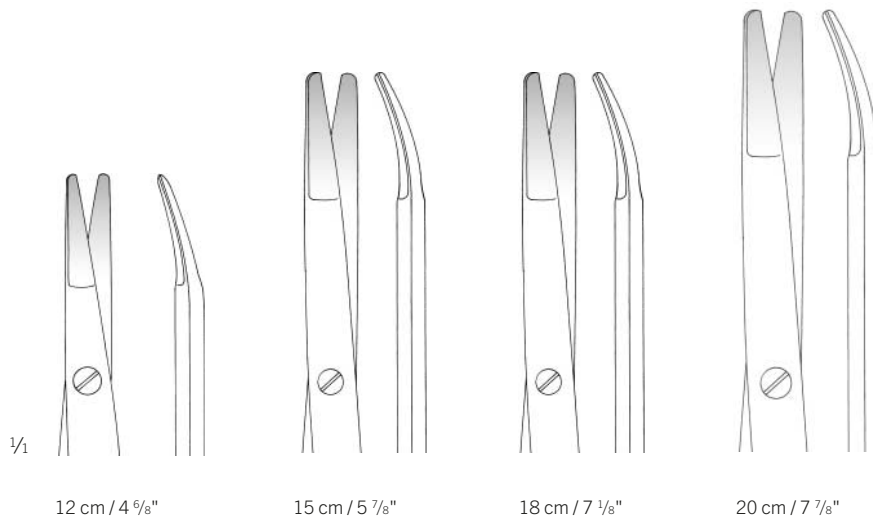
Dissecting Scissors  
Tijeras de disección  
Ciseaux à dissection  
Forbici per dissezione

## Scheren

Scissors  
Tijeras  
Ciseaux  
Forbici



| Kilner         | Standard     | SuperCut     |
|----------------|--------------|--------------|
| 12 cm / 4 5/8" | 11-359-12-07 | 11-669-12-07 |
| 15 cm / 5 7/8" | 11-359-15-07 | 11-669-15-07 |
| 18 cm / 7 1/8" | 11-359-18-07 | 11-670-18-07 |
| 20 cm / 7 7/8" | 11-359-20-07 |              |



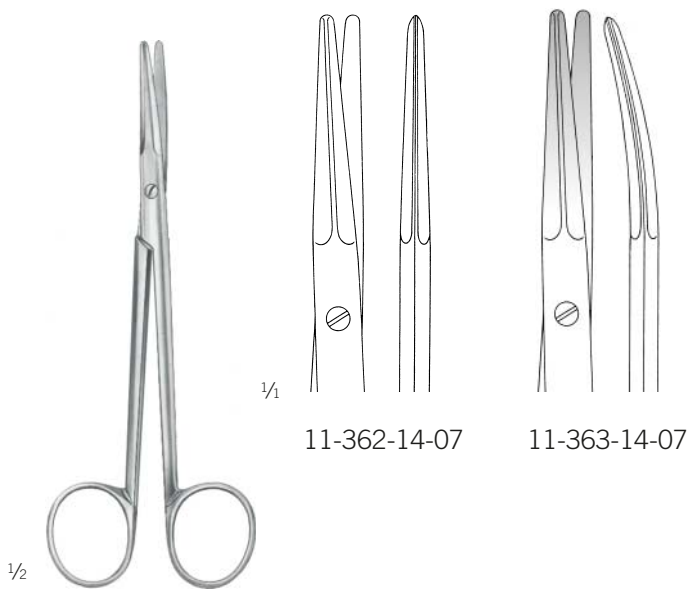
## Face-lift-Scheren

Face-lift Scissors

Tijeras para Face-lift

Ciseaux pour Face-lift

Forbici per Face-lift



11-362-14-07 -  
11-363-14-07

14,5 cm / 5  $\frac{5}{8}$ "



## Präparierscheren, Gefäßscheren

Dissecting Scissors, Vascular Scissors

Tijeras de disección, Tijeras vasculares

Ciseaux à dissection, Ciseaux vasculaires

Forbici per dissezione, Forbici vascolari

## Scheren

Scissors

Tijeras

Ciseaux

Forbici



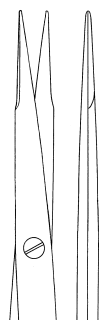
11



| Reynolds         | Standard     |
|------------------|--------------|
| 14 cm / 5 4/8"   | 11-364-14-07 |
| 15,5 cm / 6 1/8" | 11-364-15-07 |
| 18 cm / 7 1/8"   | 11-364-18-07 |



14 cm / 5 4/8"



15,5 cm / 6 1/8"



18 cm / 7 1/8"

## Präparierscheren, Gefäßscheren

Dissecting Scissors, Vascular Scissors

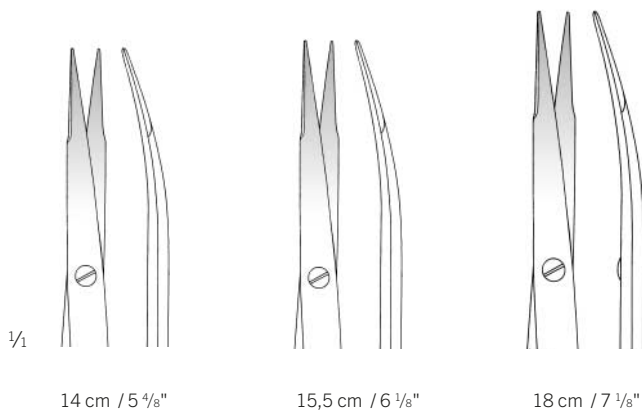
Tijeras de disección, Tijeras vasculares

Ciseaux à dissection, Ciseaux vasculaires

Forbici per dissezione, Forbici vascolari



| Reynolds                    | Standard     | SuperCut     |
|-----------------------------|--------------|--------------|
| 14 cm / 5 $\frac{4}{8}$ "   | 11-365-14-07 |              |
| 15,5 cm / 6 $\frac{1}{8}$ " | 11-365-15-07 | 11-671-15-07 |
| 18 cm / 7 $\frac{1}{8}$ "   | 11-365-18-07 | 11-671-18-07 |

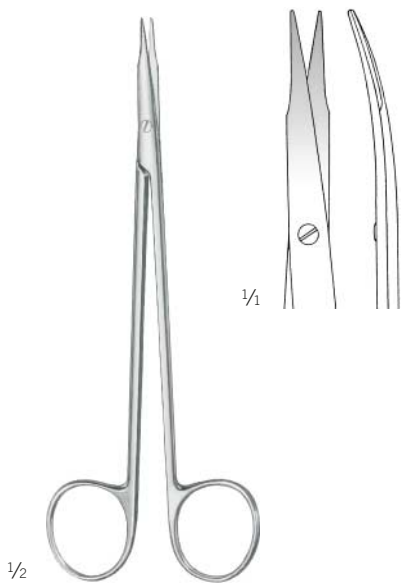


## Präparierscheren, Gefäßscheren

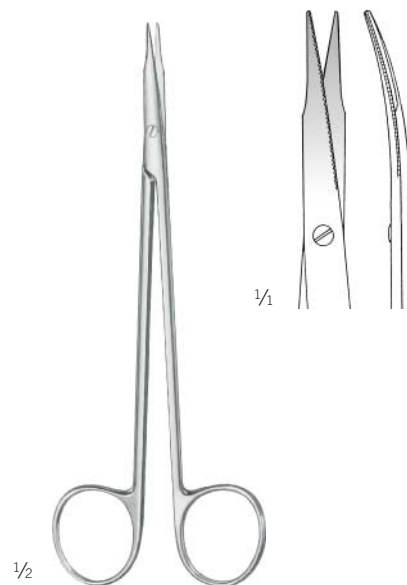
Dissecting Scissors, Vascular Scissors  
Tijeras de disección, Tijeras vasculares  
Ciseaux à dissection, Ciseaux vasculaires  
Forbici per dissezione, Forbici vascolari

## Scheren

Scissors  
Tijeras  
Ciseaux  
Forbici



Jameson  
11-367-14-07  
15,5 cm / 6 1/8"



Jameson  
11-369-14-07  
15,5 cm / 6 1/8"  
eine Schneide gezahnt  
one toothed cutting edge  
una hoja dentada  
une lame dentelée  
una lama dentata

## Kurze Mikro-Scheren

Short Micro Scissors

Micro-Tijeras, corto

Micro-Ciseaux, court

Micro-Forbici, corto













1/2

11-370-01-07 -

11-371-04-07

12 cm / 4 5/8"



|  |   |   |   |   |   |   |   |   |   |
|--|---|---|---|---|---|---|---|---|---|
| <br>safety-wave |  | <b>A</b>  | spitz/spitz<br>sharp/sharp<br>agudo/agudo<br>pointu/pointu<br>appuntato/appuntato                 | <b>A</b>  | spitz/spitz<br>sharp/sharp<br>agudo/agudo<br>pointu/pointu<br>appuntato/appuntato                 | spitz/stumpf<br>sharp/blunt<br>agudo/romo<br>pointu/mousse<br>appuntato/smusso            | <b>D</b>  | stumpf/stumpf<br>blunt/blunt<br>romo/romo<br>mousse/mousse<br>smusso/smusso                 | mit Knopf<br>with button<br>con botón<br>avec bouton<br>con bottone                                 |
|  |   | <br>7 mm | <br>11-370-01-07 | <br>7 mm | <br>11-371-01-07 | <br>7 mm | <br>11-371-02-07 | <br>7 mm | <br>11-371-03-07 |

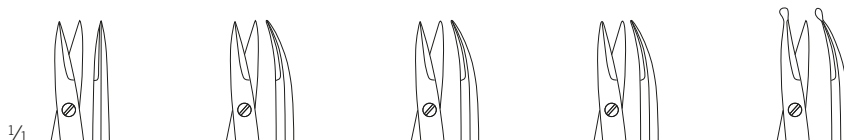


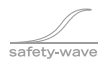









1/2

11-370-02-07 -

11-371-08-07

12 cm / 4 5/8"



|  |   |   |   |   |   |   |   |   |   |
|--|---|---|---|---|---|---|---|---|---|
| <br>safety-wave |  | <b>A</b>  | spitz/spitz<br>sharp/sharp<br>agudo/agudo<br>pointu/pointu<br>appuntato/appuntato                   | <b>A</b>  | spitz/spitz<br>sharp/sharp<br>agudo/agudo<br>pointu/pointu<br>appuntato/appuntato                   | spitz/stumpf<br>sharp/blunt<br>agudo/romo<br>pointu/mousse<br>appuntato/smusso              | <b>D</b>  | stumpf/stumpf<br>blunt/blunt<br>romo/romo<br>mousse/mousse<br>smusso/smusso                   | mit Knopf<br>with button<br>con botón<br>avec bouton<br>con bottone                                   |
|  |   | <br>7 mm | <br>11-370-02-07 | <br>7 mm | <br>11-371-05-07 | <br>7 mm | <br>11-371-06-07 | <br>7 mm | <br>11-371-07-07 |

A = Adventitia  
 D = Präparation  
 A-SB = Adventitia, ein gezahntes Blatt  
 D-SB = Präparation, ein gezahntes Blatt

A = Adventitia  
 D = Dissection  
 A-SB = Adventitia, one serrated blade  
 D-SB = Dissection, one serrated blade

A = Adventicia  
 D = Disección  
 A-SB = Adventicia, una hoja dentada  
 D-SB = Disección, una hoja dentada

A = Advantice  
 D = Dissection  
 A-SB = Advantice, une lame dentelée  
 D-SB = Dissection, une lame dentelée

A = Avventizia  
 D = Dissezione  
 A-SB = Avventizia, una lama dentata  
 D-SB = Dissezione, una lama dentata

## Präparierscheren, Gefäßscheren

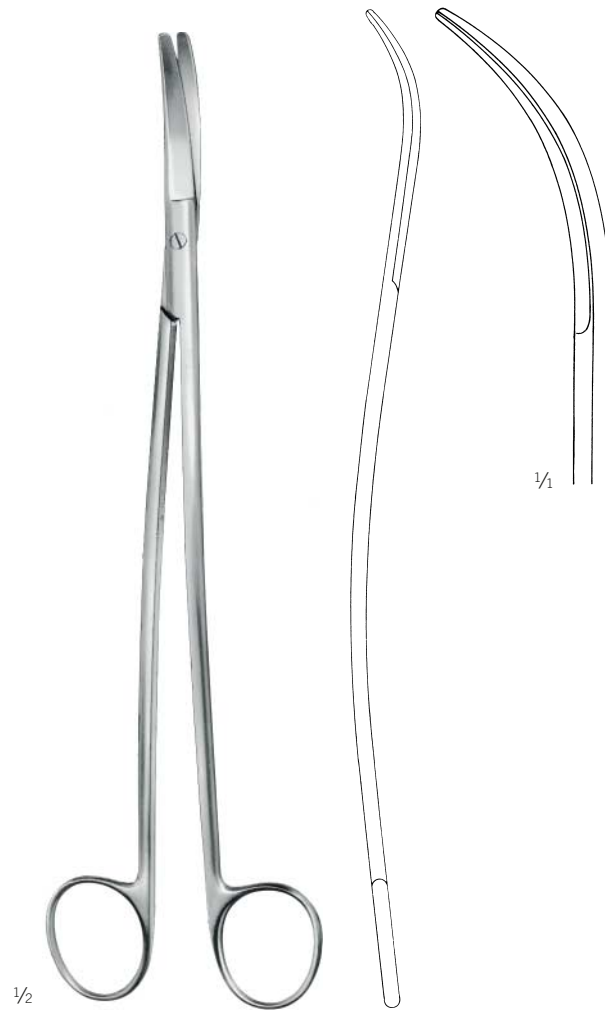
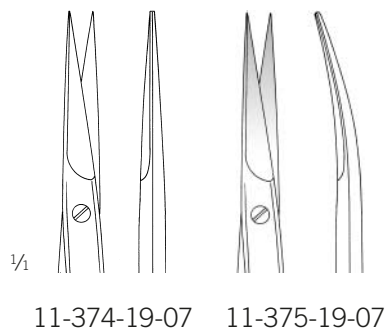
Dissecting Scissors, Vascular Scissors  
Tijeras de disección, Tijeras vasculares  
Ciseaux à dissection, Ciseaux vasculaires  
Forbici per dissezione, Forbici vascolari

## Scheren

Scissors  
Tijeras  
Ciseaux  
Forbici



11-374-19-07 -  
11-375-19-07  
20 cm / 7 7/8"



Satinsky  
11-375-24-07  
25,5 cm / 10"

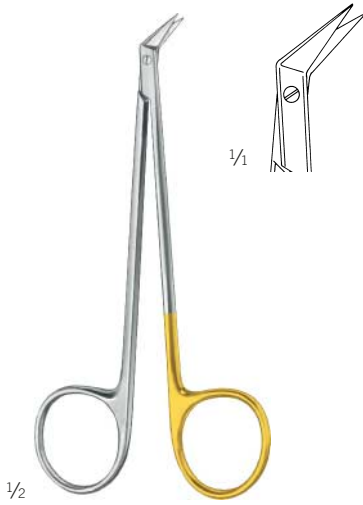
## Gefäßscheren, Koronarscheren

Vascular Scissors, Coronary Scissors

Tijeras vasculares, Tijeras coronarias

Ciseaux vasculaires, Ciseaux coronaires

Forbici vascolari, Forbici per arteria coronaria



**60°**  
Diethrich-Salyer  
11-379-45-07

12 cm / 4 5/8"

ein Blatt mit Messerschiff  
one cutting edge with knife cut  
una hoja con afilado de cuchillo  
une lame avec taille de couteau  
una lama con affilatura di coltello

für Lippen-, Kiefer-, Gaumenspalte  
for Cleft Palate  
para fisura paladar  
pour fente du palais  
per cheilo-labbro-palato schisi

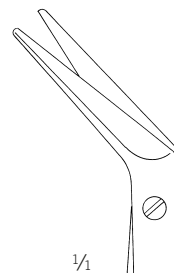


Diethrich  
11-381-01-07  
17,5 cm / 6 7/8"

**125°**  
mit Führung  
with guidance  
con guiado  
avec guide  
con guida



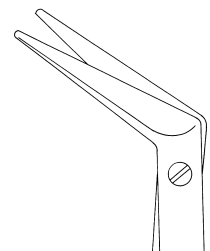
De Bakey  
11-390-45-07 -  
11-390-60-07  
16 cm / 6 3/8"



11-390-45-07

**20 mm**

**45°**



11-390-60-07

**23 mm**

**60°**

## Gefäßscheren

Vascular Scissors  
Tijeras vasculares  
Ciseaux vasculaires  
Forbici vascolari

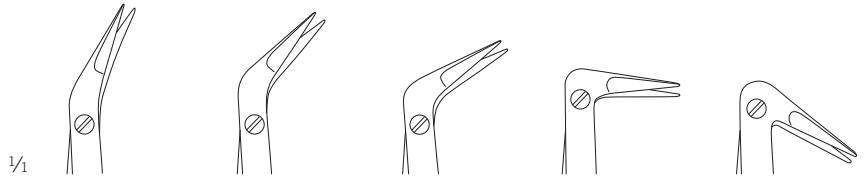
## Scheren






Scissors  
Tijeras  
Ciseaux  
Forbici



1/2

Dietrich-Potts  
11-380-25-07 -  
11-382-00-07

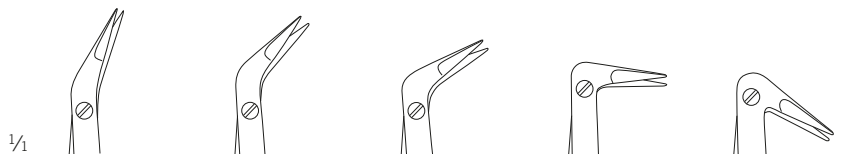







|  |   | 25°          | 45°          | 60°          | 90°          | 125°         |
|--|---|--------------|--------------|--------------|--------------|--------------|
| 18 cm / 7 1/8"   |  10 mm | 10 mm        | 10 mm        | 10 mm        | 10 mm        | 10 mm        |
|  |  St    | 11-380-25-07 | 11-380-45-07 | 11-380-60-07 | 11-380-90-07 | 11-381-00-07 |
|  18 cm / 7 1/8" |  10 mm | 10 mm        | 10 mm        | 10 mm        | 10 mm        | 10 mm        |
|  |  St   | 11-381-25-07 | 11-381-45-07 | 11-381-60-07 | 11-381-90-07 | 11-382-00-07 |



1/2

Dietrich-Potts  
11-382-25-07 -  
11-384-00-07



|  |  | 25°          | 45°          | 60°          | 90°          | 125°         |
|--|--|--------------|--------------|--------------|--------------|--------------|
| 18 cm / 7 1/8"   |  7 mm | 7 mm         | 7 mm         | 7 mm         | 7 mm         | 7 mm         |
|  |  St   | 11-382-25-07 | 11-382-45-07 | 11-382-60-07 | 11-382-90-07 | 11-383-01-07 |
|  18 cm / 7 1/8" |  7 mm | 7 mm         | 7 mm         | 7 mm         | 7 mm         | 7 mm         |
|  |  St   | 11-383-25-07 | 11-383-45-07 | 11-383-60-07 | 11-383-90-07 | 11-384-00-07 |

## Gefäßscheren

Vascular Scissors

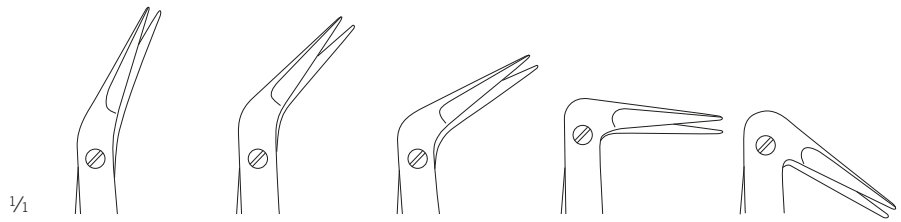
Tijeras vasculares

Ciseaux vasculaires

Forbici vascolari



1/2

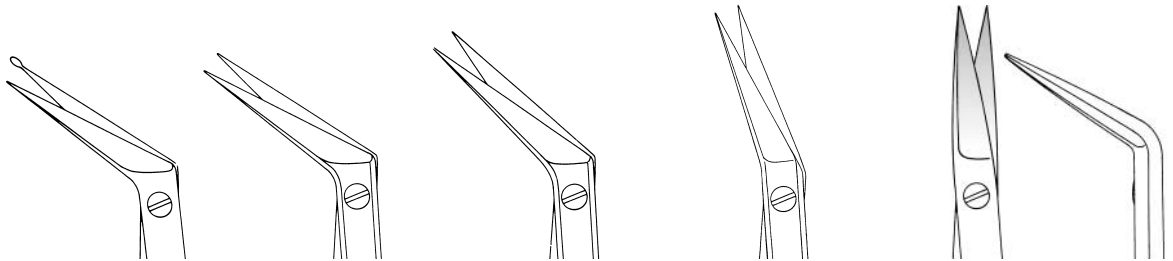


|                       |  | 25°          | 45°          | 60°          | 90°          | 125°         |
|-----------------------|--|--------------|--------------|--------------|--------------|--------------|
| <b>18 cm / 7 1/8"</b> |  | 15 mm        | 15 mm        | 15 mm        | 15 mm        | 15 mm        |
|                       |  | 11-386-25-07 | 11-386-45-07 | 11-386-60-07 | 11-386-90-07 | 11-387-00-07 |
| <b>14 cm / 5 1/8"</b> |  | 15 mm        | 15 mm        | 15 mm        | 15 mm        | 15 mm        |
|                       |  | 11-387-25-07 | 11-387-45-07 | 11-387-60-07 | 11-387-90-07 | 11-388-00-07 |

Dietrich-Hegemann  
11-386-25-07 -  
11-388-00-07



1/2



1/4

11-391-19-07

18 cm / 7 1/8"



20 mm

60°

11-393-19-07

18 cm / 7 1/8"



20 mm

60°

11-394-19-07

18,5 cm / 7 2/8"



20 mm

40°

11-395-19-07

19 cm / 7 4/8"



20 mm

25°

11-397-19-07

19,5 cm / 7 5/8"



20 mm

25°

Potts-Smith  
11-391-19-07 -  
11-397-19-07



## Gefäßscheren

Vascular Scissors  
Tijeras vasculares  
Ciseaux vasculaires  
Forbici vascolari

## Scheren

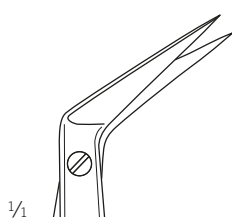
Scissors  
Tijeras  
Ciseaux  
Forbici



11



Potts-Smith  
11-396-19-07 -  
11-398-19-07

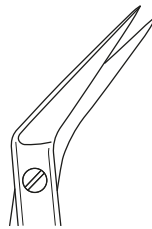


11-396-19-07  
18 cm / 7 1/8"



20 mm

60°



11-398-19-07  
18,5 cm / 7 2/8"



20 mm

40°

## Mikro-Scheren

Micro Scissors

Micro-Tijeras

Micro-Ciseaux

Micro-Forbici

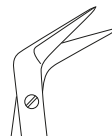
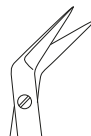


1/2

11-384-25-07 -  
11-401-00-07



1/1



|                       |  | 25°          | 45°          | 60°          | 90°          | 125°         |
|-----------------------|--|--------------|--------------|--------------|--------------|--------------|
|                       |  | 10 mm        | 10 mm        | 10 mm        | 10 mm        | 10 mm        |
| <b>18 cm / 7 1/8"</b> |  | 11-400-25-07 | 11-400-45-07 | 11-400-60-07 | 11-400-90-07 | 11-401-00-07 |
| <b>21 cm / 8 2/8"</b> |  | 11-384-25-07 | 11-384-45-07 | 11-384-60-07 | 11-384-90-07 | 11-385-00-07 |

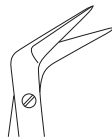
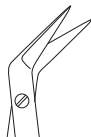


1/2

11-412-25-07 -  
11-437-00-07



1/1



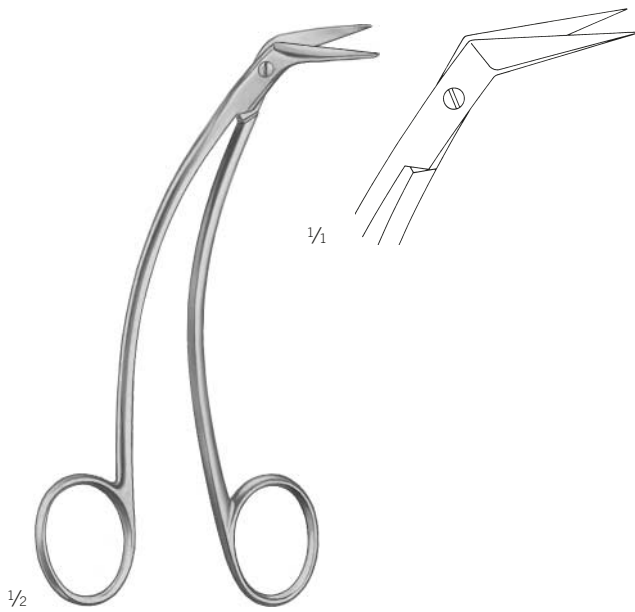
|                       |  | 25°          | 45°          | 60°          | 90°          | 125°         |
|-----------------------|--|--------------|--------------|--------------|--------------|--------------|
|                       |  | 10 mm        | 10 mm        | 10 mm        | 10 mm        | 10 mm        |
| <b>18 cm / 7 1/8"</b> |  | 11-412-25-07 | 11-412-45-07 | 11-412-60-07 | 11-412-90-07 | 11-413-00-07 |
| <b>21 cm / 8 2/8"</b> |  | 11-436-25-07 | 11-436-45-07 | 11-436-60-07 | 11-436-90-07 | 11-437-00-07 |

## Gefäßscheren

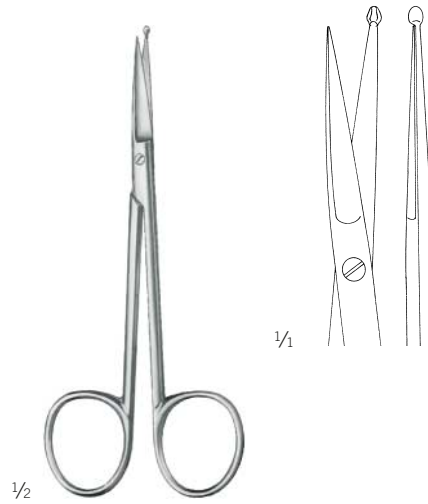
Vascular Scissors  
Tijeras vasculares  
Ciseaux vasculaires  
Forbici vascolari

## Scheren

Scissors  
Tijeras  
Ciseaux  
Forbici



40°  
Favaloro  
11-419-90-07  
14,5 cm / 5 5/8"

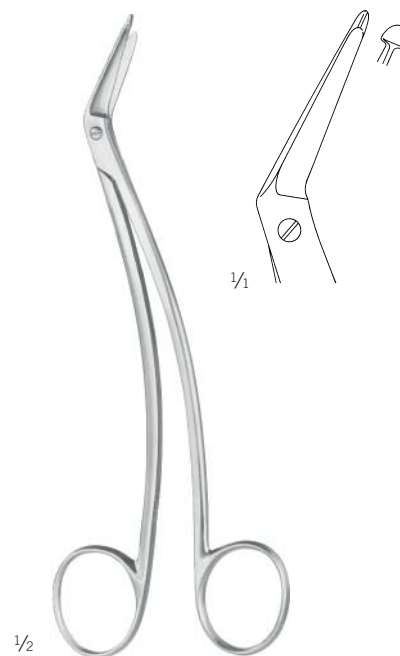


11-420-11-07  
12 cm / 4 5/8"



Strully  
11-445-22-07 - 11-446-22-07  
22 cm / 8 5/8"

Neurochirurgische Schere  
Neurosurgical scissors  
Tijeras para neurocirugía  
Ciseaux pour neurochirurgie  
Forbici per neurochirurgia



40°  
Schmieden-Taylor  
11-455-17-07  
16,5 cm / 6 4/8"

# Feine Präparierscheren

Delicate Dissecting Scissors

Tijeras finas de disección

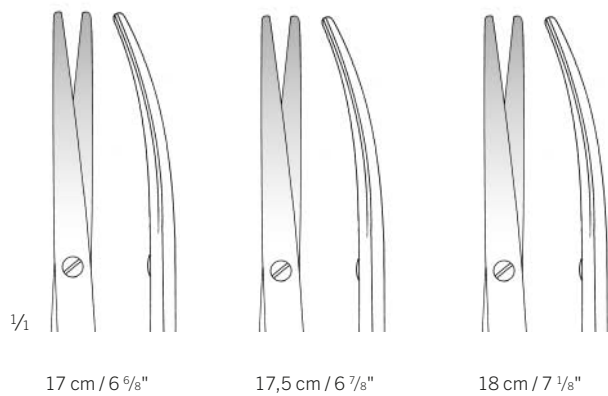
Ciseaux fins à dissection

Forbici fini per dissezione

## finoLine



| Toennis-Adson    | Standard     | TC GOLD      | AQUILA       | TCCBlackLine | ST           |
|------------------|--------------|--------------|--------------|--------------|--------------|
| 17 cm / 6 5/8"   |              |              |              | 11-921-17-07 |              |
| 17,5 cm / 6 7/8" | 11-459-17-07 | 11-965-17-07 | 11-893-17-07 |              |              |
| 18 cm / 7 1/8"   |              |              | 28-477-18-07 |              | 28-437-18-07 |



## Präparierscheren

Dissecting Scissors  
Tijeras de disección  
Ciseaux à dissection  
Forbici per dissezione

## Scheren

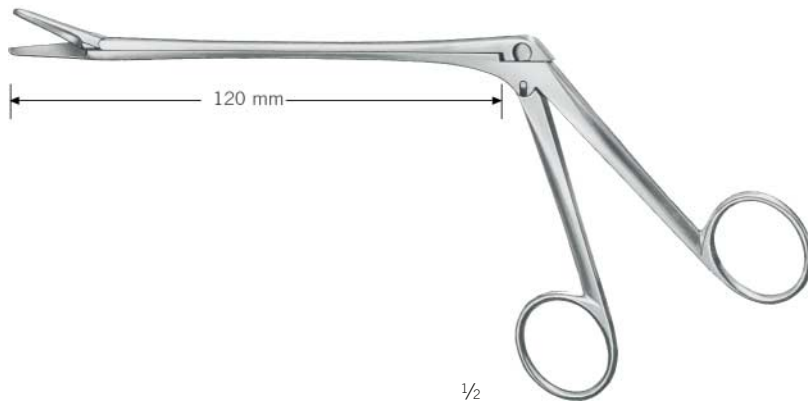
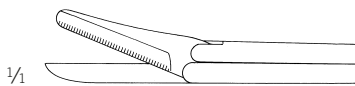
Scissors  
Tijeras  
Ciseaux  
Forbici



11

Arbeitslänge  
working length  
largo útil  
longueur utile  
lunghezza utile

**120 mm**



Olivecrona  
11-475-23-07

13 cm / 5 1/8"

Trigeminusschere  
Trigeminal scissors  
Tijeras para nervio trigémino  
Ciseaux pour le nerf trigéminal  
Forbici per il nervo trigemino

eine Schneide gezahnt  
one toothed cutting edge  
una hoja dentada  
une lame dentelée  
una lama dentata

## Tonsillenscheren

Tonsil Scissors

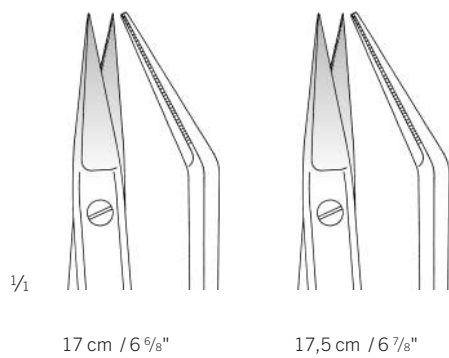
Tijeras para amígdalas

Ciseaux pour les amygdales

Forbici per tonsille



| Dean             | Standard     | ST           |
|------------------|--------------|--------------|
| 17 cm / 6 5/8"   |              | 28-463-17-07 |
| 17,5 cm / 6 7/8" | 11-495-17-07 |              |

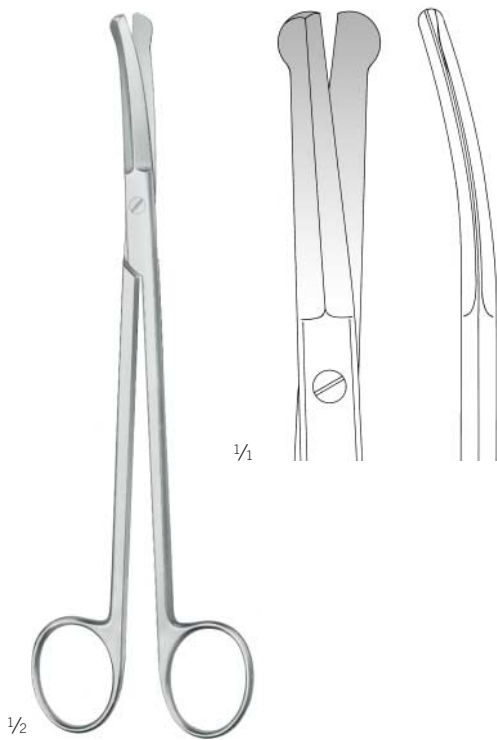


## Tonsillenscheren

Tonsil Scissors  
Tijeras para amígdalas  
Ciseaux pour les amygdales  
Forbici per tonsille

## Scheren

Scissors  
Tijeras  
Ciseaux  
Forbici



Good  
11-499-19-07  
19,5 cm / 7 5/8"

## Tonsillenscheren

Tonsil Scissors

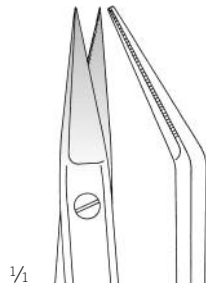
Tijeras para amígdalas

Ciseaux pour les amygdales

Forbici per tonsille



| Dean             | Standard     | TCGOLD       |
|------------------|--------------|--------------|
|                  | 25°          | 25°          |
| 17,5 cm / 6 7/8" | 11-497-17-07 | 11-994-17-07 |



eine Schneide gezahnt  
 one toothed cutting edge  
 una hoja dentada  
 une lame dentelée  
 una lama dentata



## Nasenscheren

Nasal Scissors  
Tijeras nasales  
Ciseaux nasaux  
Forbici nasali

## Scheren

Scissors  
Tijeras  
Ciseaux  
Forbici



11



$\frac{1}{2}$

$\frac{1}{2}$

40°  
Fomon  
11-503-15-07  
14,5 cm / 5  $\frac{6}{8}$ "

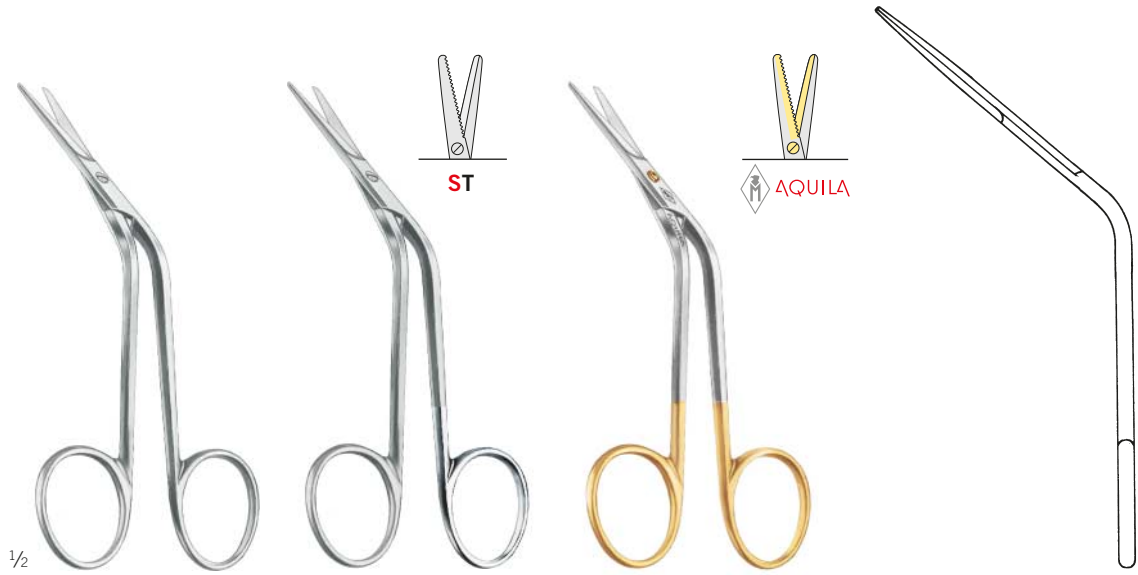
# Nasenscheren

Nasal Scissors

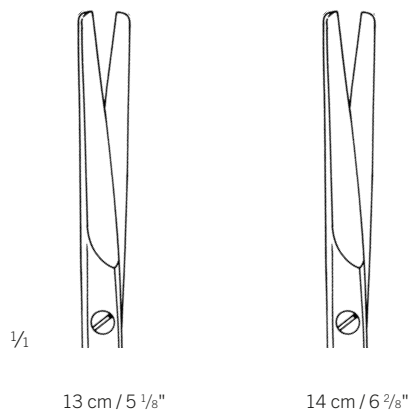
Tijeras nasales

Ciseaux nasaux

Forbici nasali



| Fomon          | Standard     | ST           | AQUILA       |
|----------------|--------------|--------------|--------------|
|                | 40°          | 40°          | 40°          |
| 13 cm / 5 1/8" |              | 28-459-13-07 | 28-481-13-07 |
| 14 cm / 6 2/8" | 11-507-15-07 |              |              |



13 cm / 5 1/8"

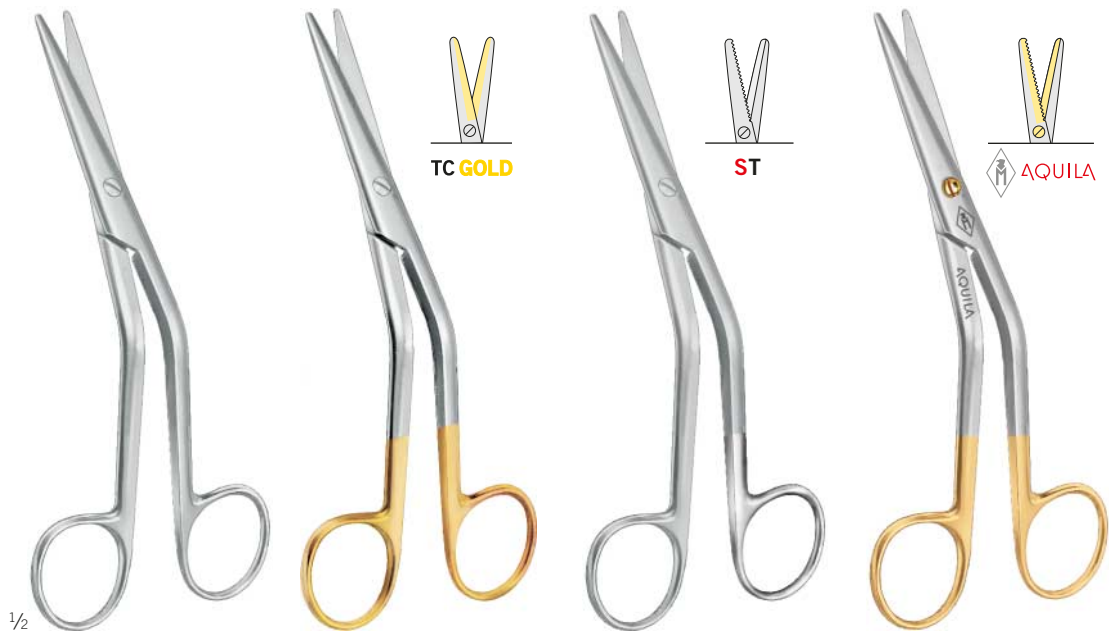
14 cm / 6 2/8"

## Nasenscheren

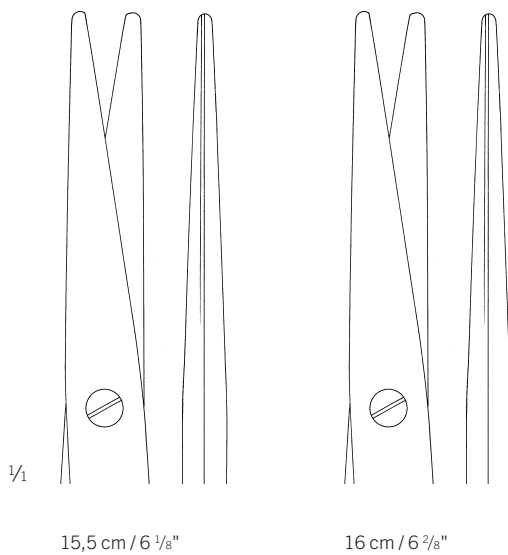
Nasal Scissors  
Tijeras nasales  
Ciseaux nasaux  
Forbici nasali

## Scheren

Scissors  
Tijeras  
Ciseaux  
Forbici



| Cottle           | Standard     | TCGOLD       | ST           | AQUILA       |
|------------------|--------------|--------------|--------------|--------------|
|                  | 40°          | 40°          | 40°          | 40°          |
| 15,5 cm / 6 1/8" | 11-509-16-07 |              |              |              |
| 16 cm / 6 3/8"   |              | 11-505-16-07 | 28-461-16-07 | 28-479-16-07 |



# Nasenscheren

Nasal Scissors

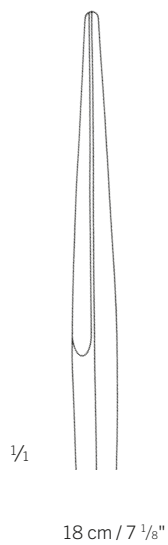
Tijeras nasales

Ciseaux nasaux

Forbici nasali



| Heymann        | Standard     | ST           |
|----------------|--------------|--------------|
|                | 40°          | 40°          |
| 18 cm / 7 1/8" | 11-511-18-07 | 28-453-18-07 |



## Nasenscheren

Nasal Scissors

Tijeras nasales

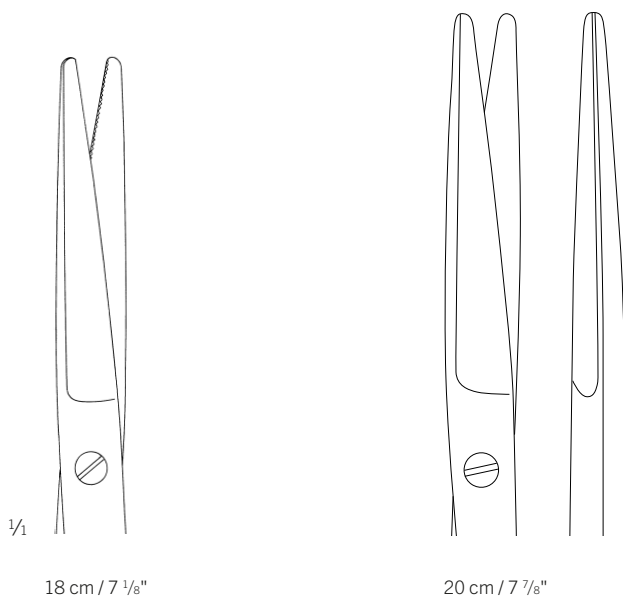
Ciseaux nasaux

Forbici nasali



| Heymann        | Standard     | Standard     |
|----------------|--------------|--------------|
|                | 40°          | 40°          |
| 18 cm / 7 1/8" | 11-513-18-07 |              |
| 20 cm / 7 7/8" |              | 11-510-20-07 |

eine Schneide gezahnt  
 one toothed cutting edge  
 una hoja dentada  
 une lame dentelée  
 una lama dentata



## Nasenscheren

Nasal Scissors

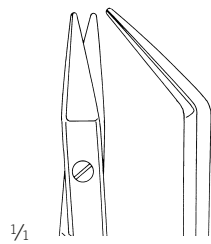
Tijeras nasales

Ciseaux nasaux

Forbici nasali

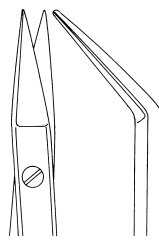


Converse  
11-517-11-07 -  
11-519-11-07  
10,5 cm / 4 1/8"



40°  
11-517-11-07

stumpf  
blunt  
romo  
mousse  
smusso



40°  
11-519-11-07

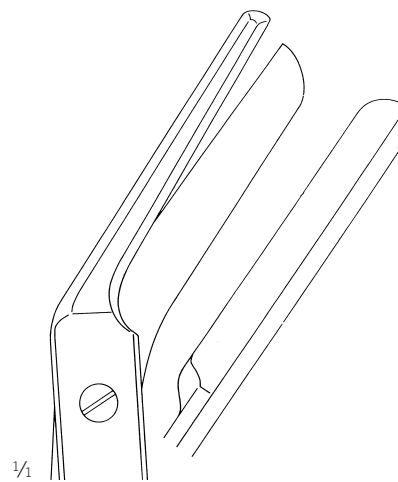
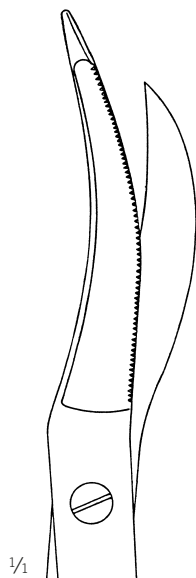
spitz  
sharp  
agudo  
pointu  
appuntato

## Episiotomiescheren

Episiotomy Scissors  
Tijeras para episiotomía  
Ciseaux à épisiotomie  
Forbici per episiotomia

## Scheren

Scissors  
Tijeras  
Ciseaux  
Forbici



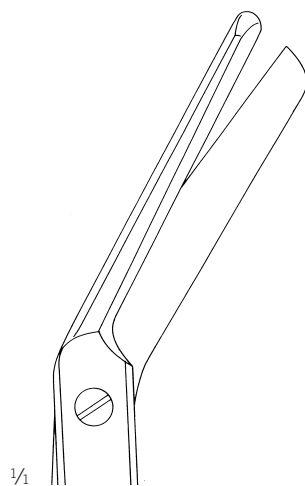
Waldmann  
11-531-18-07

18 cm / 7 1/8"

eine Schneide gezahnt  
one toothed cutting edge  
una hoja dentada  
une lame dentelée  
una lama dentata

35°  
Braun-Stadler  
11-535-14-07

14,5 cm / 5 6/8"



30°  
Braun-Stadler  
11-537-22-07

22 cm / 8 5/8"

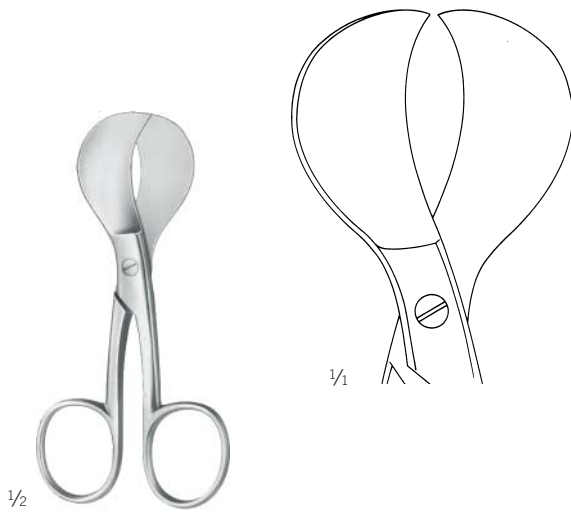
## Nabelschnurscheren

Umbilical Scissors

Tijeras umbilicales

Ciseaux pour le cordon ombilical

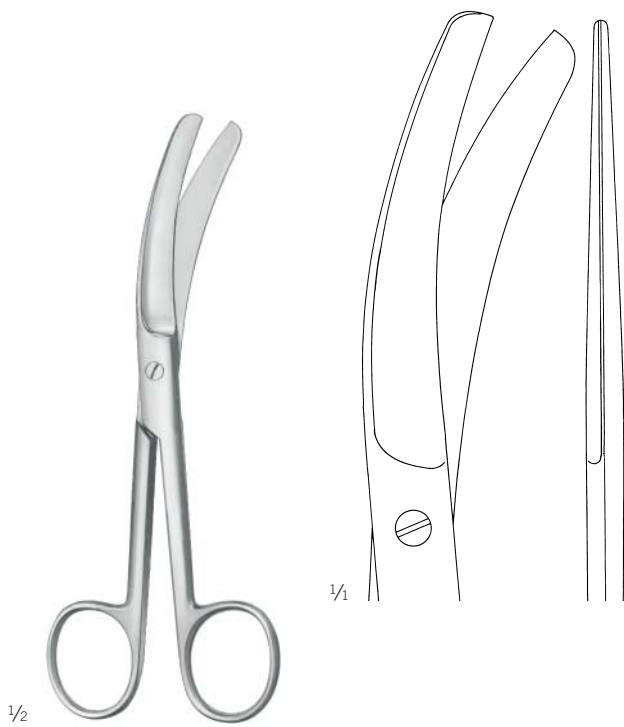
Forbici ombelicali



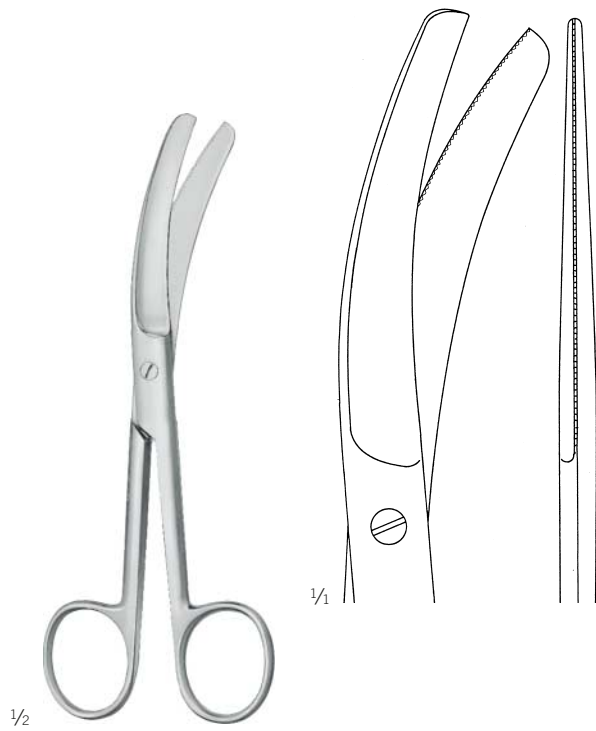
Mod. USA  
11-545-10-07  
10,5 cm / 4 1/8"



Schuhmacher  
11-547-16-07  
15,5 cm / 6 1/8"



Busch  
11-551-16-07  
16 cm / 6 2/8"



Busch  
11-553-16-07  
16 cm / 6 2/8"  
eine Schneide gezahnt  
one toothed cutting edge  
una hoja dentada  
una lame dentelée  
una lama dentata



# Chirurgische Scheren, Zahnfleischscheren

Operating Scissors, Gum Scissors

Tijeras quirúrgicas, Tijeras para encías

Ciseaux chirurgicaux, Ciseaux à gencives

Forbici per chirurgia, Forbici per gengiva

# Scheren

Scissors

Tijeras

Ciseaux

Forbici

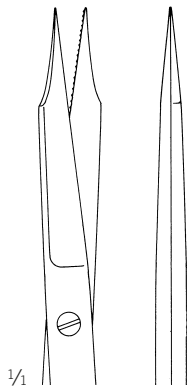


11



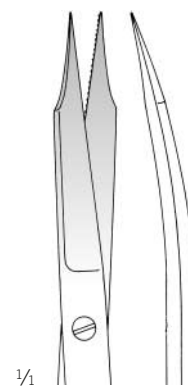
| Goldman-Fox    | Standard     | TC GOLD      |
|----------------|--------------|--------------|
| 13 cm / 5 1/8" | 11-566-13-07 | 11-980-13-07 |

| Standard     | TC GOLD      |
|--------------|--------------|
| 11-567-13-07 | 11-981-13-07 |



13 cm / 5 1/8"

eine Schneide gezahnt  
one toothed cutting edge  
una hoja dentada  
une lame dentelée  
una lama dentata



13 cm / 5 1/8"

eine Schneide gezahnt  
one toothed cutting edge  
una hoja dentada  
une lame dentelée  
una lama dentata

## Chirurgische Scheren, Zahnfleischscheren

Operating Scissors, Gum Scissors

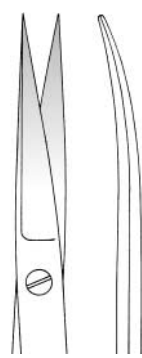
Tijeras quirúrgicas, Tijeras para encías

Ciseaux chirurgicaux, Ciseaux à gencives

Forbici per chirurgia, Forbici per gengiva



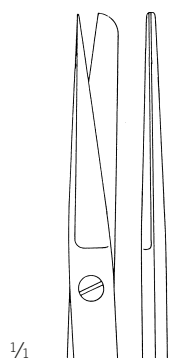
11-570-12-07



11-571-12-07

Wagner  
11-570-12-07 -  
11-571-12-07

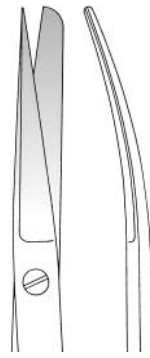
12 cm / 4 5/8"



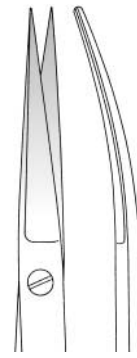
11-582-12-07



11-584-12-07



11-587-12-07



11-589-12-07

11-582-12-07 -  
11-589-12-07

12 cm / 4 5/8"

## Chirurgische Scheren, Zahnfleischscheren

Operating Scissors, Gum Scissors

Tijeras quirúrgicas, Tijeras para encías

Ciseaux chirurgicaux, Ciseaux à gencives

Forbici per chirurgia, Forbici per gengiva

## Scheren

Scissors

Tijeras

Ciseaux

Forbici



11



La Grange

11-593-11-07

11,5 cm / 4 1/8"

S-Form, eine Schneide gezahnt  
S-shape, one toothed cutting edge  
forma S, una hoja dentada  
courbé en S, une lame dentelée  
curvo in forma S, una lama de



11-594-11-07 -

11-595-11-07

11,5 cm / 4 1/8"

fein  
delicate  
fino  
fin  
fino

# Zahnfleischscheren

Gum Scissors

Tijeras para encías

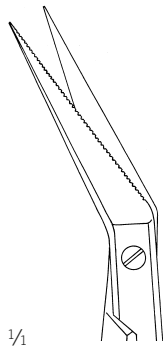
Ciseaux à gencives

Forbici per gengiva

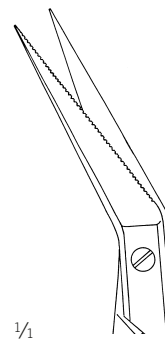


|                | Standard     | TC GOLD      |
|----------------|--------------|--------------|
|                | 25°          | 25°          |
| 16 cm / 6 2/8" | 11-605-16-07 | 11-999-16-07 |

|  | Standard     | TC GOLD      |
|--|--------------|--------------|
|  | 25°          | 25°          |
|  | 11-607-16-07 | 11-997-16-07 |



eine Schneide gezahnt  
one toothed cutting edge  
una hoja dentada  
une lame dentelée  
una lama dentata



eine Schneide gezahnt  
one toothed cutting edge  
una hoja dentada  
une lame dentelée  
una lama dentata

## Irisscheren

Iris Scissors

Tijeras para iridectomía

Ciseaux à iridectomie

Forbici per iridectomia

## Scheren

Scissors

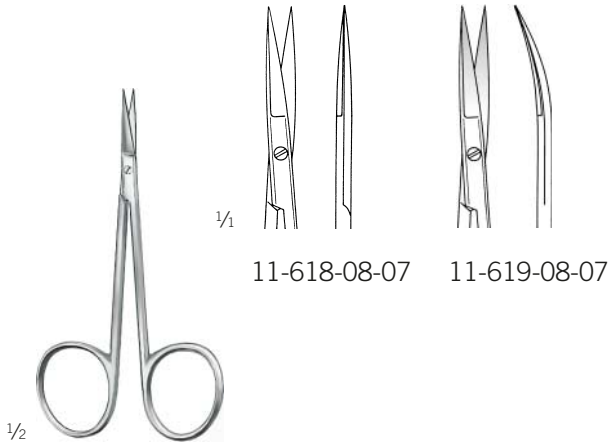
Tijeras

Ciseaux

Forbici



11



11-618-08-07

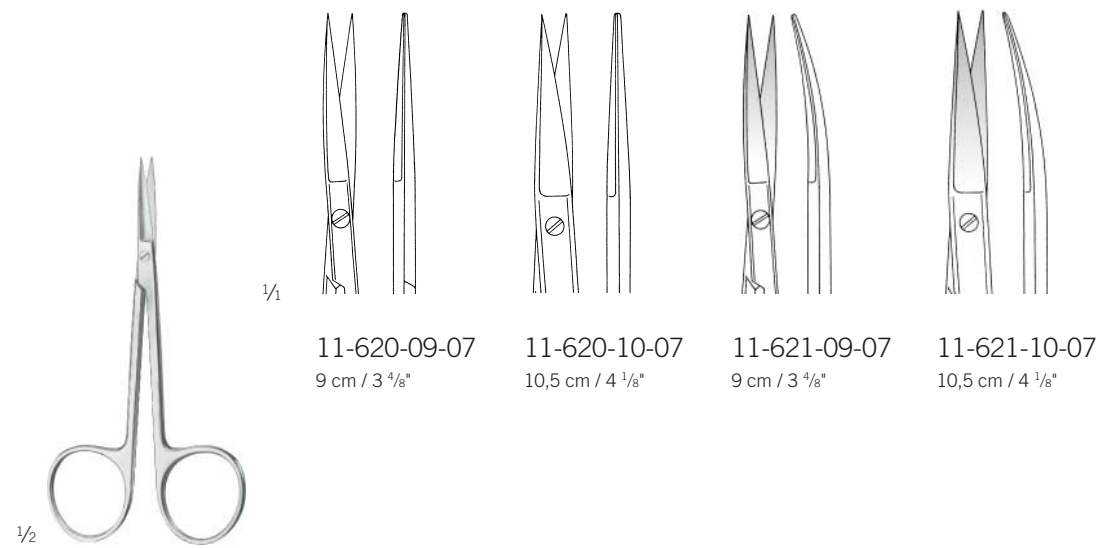
11-619-08-07

11-618-08-07 -  
11-619-08-07  
9 cm / 3 4/8"  
sehr fein  
very delicate  
muy fino  
très fin  
strafino



11-622-10-07

10,5 cm / 4 1/8"  
extra flache Blätter  
extra flat blades  
hojas muy delgadas  
lames extrêmement plates  
con lame molto piate



11-620-09-07  
9 cm / 3 4/8"

11-620-10-07  
10,5 cm / 4 1/8"

11-621-09-07  
9 cm / 3 4/8"

11-621-10-07  
10,5 cm / 4 1/8"

11-620-09-07 -  
11-621-10-07

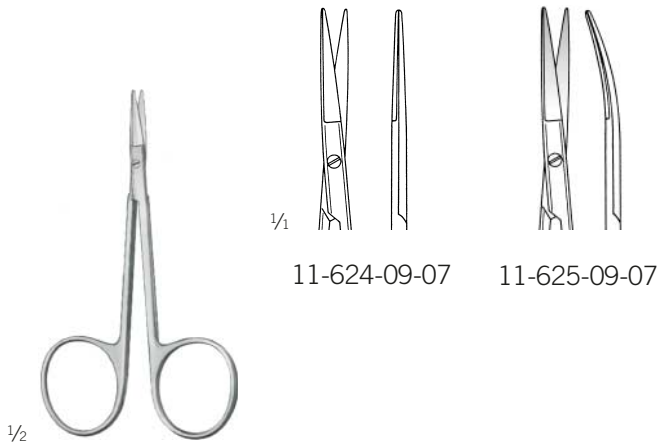
## Irisscheren

Iris Scissors

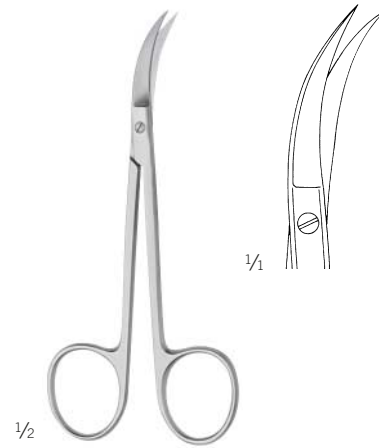
Tijeras para iridectomía

Ciseaux à iridectomie

Forbici per iridectomia



Mod. Bonn  
11-624-09-07 -  
11-625-09-07  
9 cm / 3 4/8"



11-633-11-07  
11,5 cm / 4 1/8"



11-640-12-07 -  
11-641-12-07  
12,5 cm / 4 7/8"

## Irisscheren

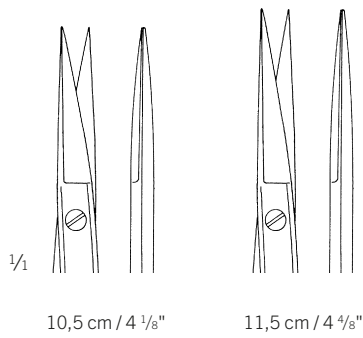
Iris Scissors  
Tijeras para iridectomía  
Ciseaux à iridectomie  
Forbici per iridectomia

## Scheren

Scissors  
Tijeras  
Ciseaux  
Forbici



|                  | Standard     | TC GOLD      | SuperCut     | AQUILA       |
|------------------|--------------|--------------|--------------|--------------|
| 10,5 cm / 4 1/8" |              |              | 11-672-10-07 |              |
| 11,5 cm / 4 5/8" | 11-630-11-07 | 11-982-11-07 | 11-672-11-07 | 28-464-11-07 |



# Irisscheren

Iris Scissors

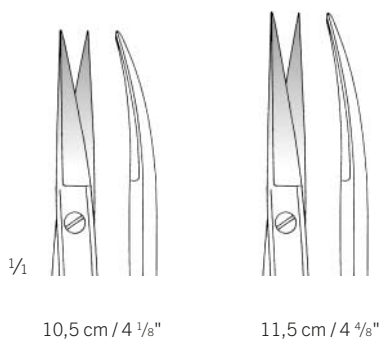
Tijeras para iridectomía

Ciseaux à iridectomie

Forbici per iridectomia



|                  | Standard     | TC GOLD      | SuperCut     | AQUILA       |
|------------------|--------------|--------------|--------------|--------------|
| 10,5 cm / 4 1/8" |              |              | 11-673-10-07 |              |
| 11,5 cm / 4 5/8" | 11-631-11-07 | 11-983-11-07 | 11-673-11-07 | 28-465-11-07 |



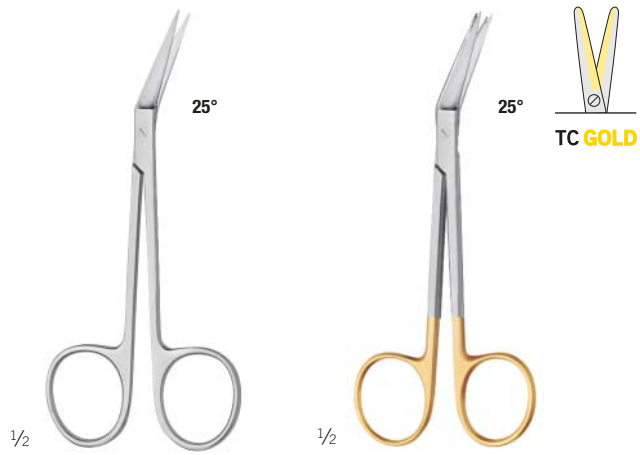


## Irisscheren

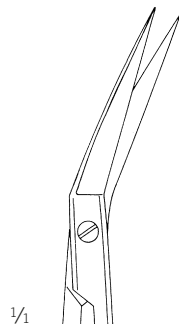
Iris Scissors  
Tijeras para iridectomía  
Ciseaux à iridectomie  
Forbici per iridectomia

## Scheren

Scissors  
Tijeras  
Ciseaux  
Forbici



|                  | Standard     | TCGOLD       |
|------------------|--------------|--------------|
| 11,5 cm / 4 7/8" | 11-635-11-07 | 11-989-11-07 |



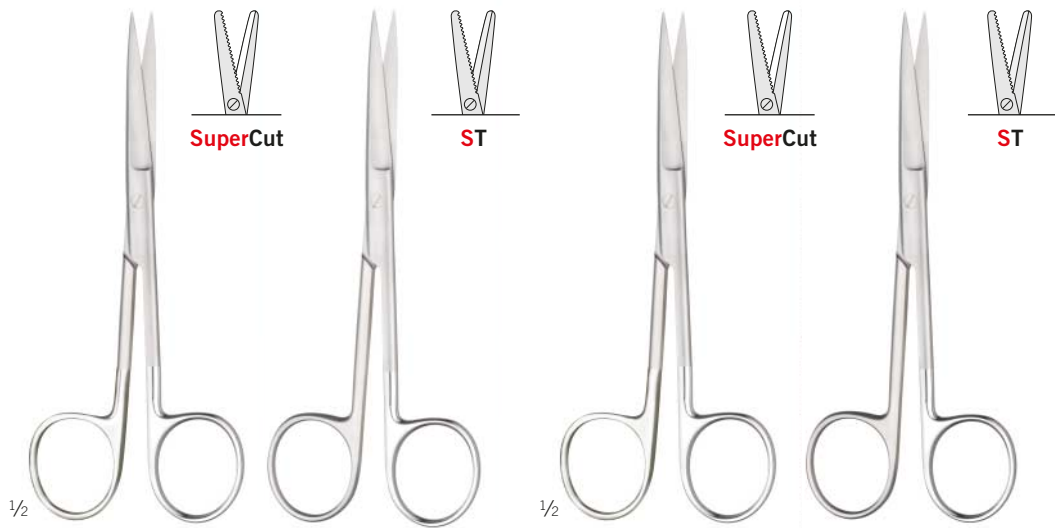
# Irisscheren

Iris Scissors

Tijeras para iridectomía

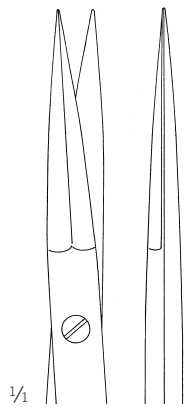
Ciseaux à iridectomie

Forbici per iridectomia

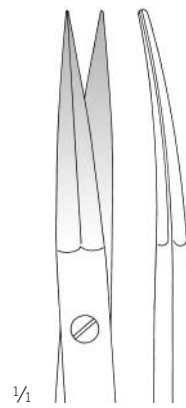


| Jabaley        | SuperCut     | ST           |
|----------------|--------------|--------------|
| 13 cm / 5 1/8" | 11-644-13-07 | 28-400-13-07 |

| SuperCut     | ST           |
|--------------|--------------|
| 11-645-13-07 | 28-401-13-07 |



13 cm / 5 1/8"



13 cm / 5 1/8"

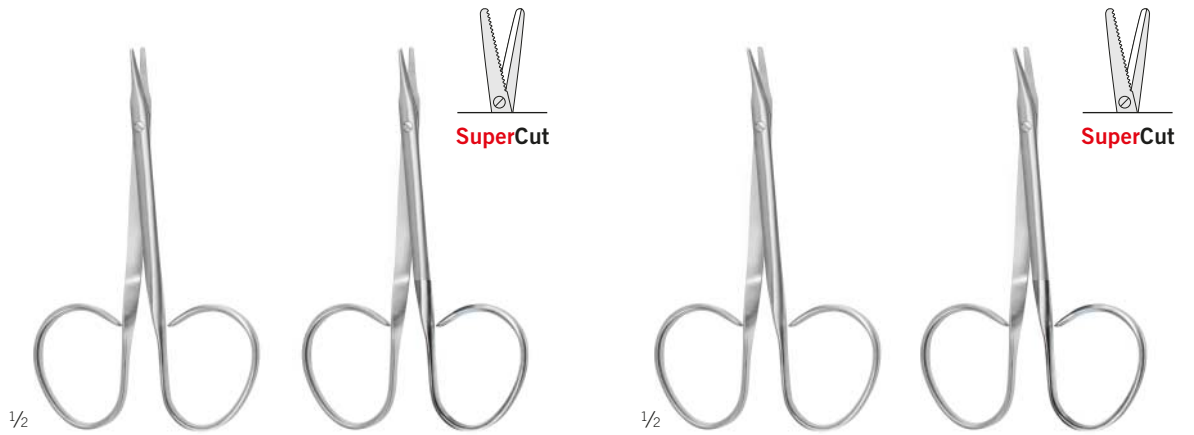
# Irisscheren

Iris Scissors

Tijeras para iridectomía

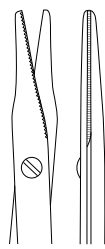
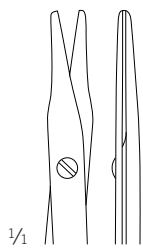
Ciseaux à iridectomie

Forbici per iridectomia



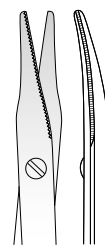
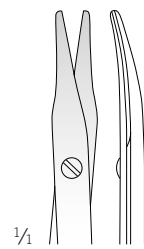
| Stevens          | Standard     | SuperCut     |
|------------------|--------------|--------------|
| 10 cm / 3 7/8"   | 11-678-10-07 |              |
| 10,5 cm / 4 1/8" |              | 11-676-10-07 |
| 11 cm / 4 3/8"   | 11-682-11-07 |              |

| Standard     | SuperCut     |
|--------------|--------------|
| 11-679-10-07 |              |
|              | 11-677-10-07 |
| 11-683-11-07 |              |



1/1

stumpf/stumpf  
blunt/blunt  
romo/romo  
mousse/mousse  
smusso/smusso



1/1

stumpf/stumpf  
blunt/blunt  
romo/romo  
mousse/mousse  
smusso/smusso

# Irisscheren

Iris Scissors

Tijeras para iridectomía

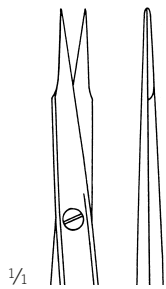
Ciseaux à iridectomie

Forbici per iridectomia



| Stevens          | Standard     | SuperCut     |
|------------------|--------------|--------------|
| 10,5 cm / 4 1/8" |              | 11-674-10-07 |
| 11 cm / 4 3/8"   | 11-680-11-07 |              |

| Standard     | SuperCut     |
|--------------|--------------|
|              | 11-675-10-07 |
| 11-681-11-07 |              |



spitz/spitz  
sharp/sharp  
agudo/agudo  
pointu/pointu  
appuntato/appuntato



spitz/spitz  
sharp/sharp  
agudo/agudo  
pointu/pointu  
appuntato/appuntato

## Strabismusscheren

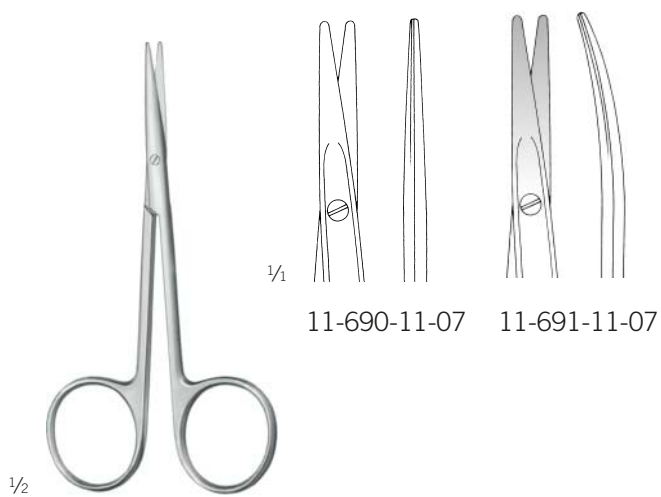
Strabismus Scissors  
Tijeras para estrabismo  
Ciseaux à strabisme  
Forbici per strabismo

## Scheren

Scissors  
Tijeras  
Ciseaux  
Forbici



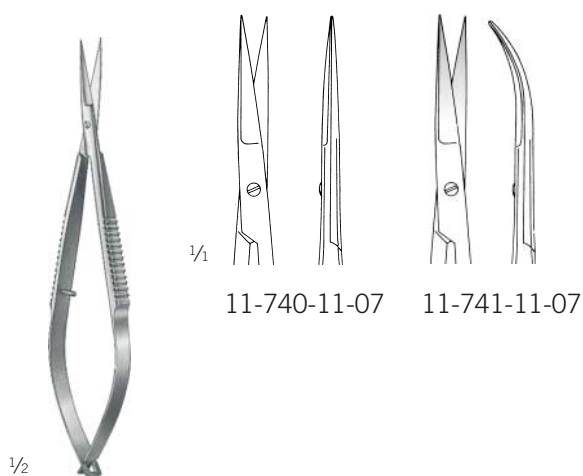
11



11-690-11-07 -  
11-691-11-07  
11,5 cm / 4 5/8"



11-705-11-07  
11,5 cm / 4 5/8"  
Enukleationsschere  
Enucleation Scissors  
Tijera para enucleación  
Ciseaux à énucléation  
Forbici per enucleazione



Westcott  
11-740-11-07 -  
11-741-11-07  
11,5 cm / 4 5/8"

# Mikro-Scheren

Micro Scissors

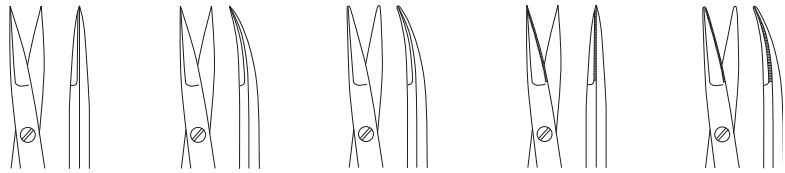
Micro-Tijeras

Micro-Ciseaux

Micro-Forbici



1/1



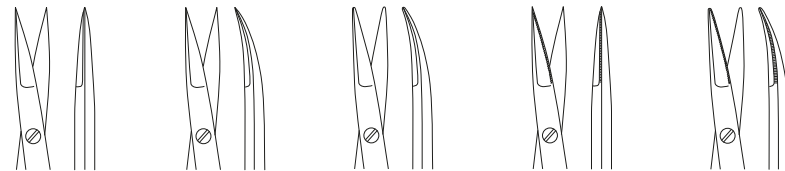
|                |  | D            | A-SB         | D-SB         |              |              |
|----------------|--|--------------|--------------|--------------|--------------|--------------|
| 15 cm / 5 7/8" |  | 10 mm        | 10 mm        | 10 mm        |              |              |
|                |  | 11-710-15-07 | 11-711-15-07 |              |              |              |
| 18 cm / 7 1/8" |  | 11-710-18-07 | 11-711-18-07 | 11-711-19-07 | 11-710-19-07 | 11-711-20-07 |

1/2

11-710-15-07 -  
11-711-20-07



1/1



|                |  | D            | A-SB         | D-SB         |              |              |
|----------------|--|--------------|--------------|--------------|--------------|--------------|
| 15 cm / 5 7/8" |  | 10 mm        | 10 mm        | 10 mm        |              |              |
|                |  | 11-712-15-07 | 11-713-15-07 |              |              |              |
| 18 cm / 7 1/8" |  | 11-712-18-07 | 11-713-18-07 | 11-713-19-07 | 11-712-19-07 | 11-713-20-07 |

1/2

11-712-15-07 -  
11-713-20-07

A = Adventitia  
D = Präparation  
A-SB = Adventitia, ein gezahntes Blatt  
D-SB = Präparation, ein gezahntes Blatt

A = Adventitia  
D = Dissection  
A-SB = Adventitia, one serrated blade  
D-SB = Dissection, one serrated blade

A = Adventicia  
D = Disección  
A-SB = Adventicia, una hoja dentada  
D-SB = Disección, una hoja dentada

A = Advantice  
D = Dissection  
A-SB = Advantice, une lame dentelée  
D-SB = Dissection, une lame dentelée

A = Avventizia  
D = Dissezione  
A-SB = Avventizia, una lama dentata  
D-SB = Dissezione, una lama dentata

## Mikro-Scheren

Micro Scissors

Micro-Tijeras

Micro-Ciseaux

Micro-Forbici

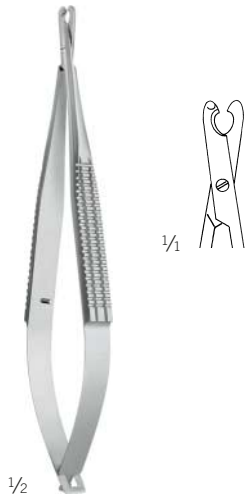
## Scheren

Scissors

Tijeras

Ciseaux

Forbici



1/2

Biemer

11-758-12-07

12 cm / 4 5/8"

Mikro-Venenschere

Micro scissors for veins

Tijeras de micro para venas

Micro-ciseaux pour les veines

Forbici micro per vene

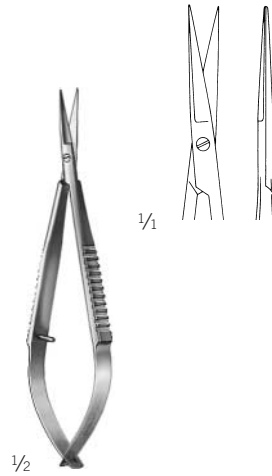
Zum Auffrischen von Gefäßstümpfen. Kein Abgleiten des Gefäßes und glatte, saubere Durchtrennung

For roughening vessel ends, vessel cannot slip off, clean, smooth cut

Renovación de extremos vasculares. Ningún resbalamiento del vaso, cortes limpios y lisos

Pour rafraîchir des moignons vasculaires. Les vaisseau ne peut pas glisser, coupe lisse et propre

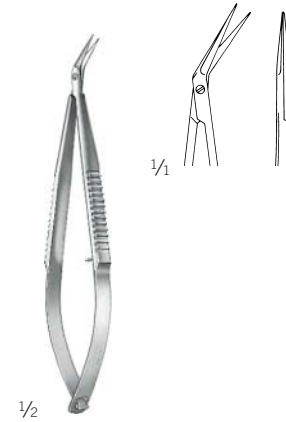
Per cruentare le estremità vasili. Senza scivolamento del vaso, con distacco preciso



1/2

11-760-09-07

10 cm / 3 7/8"



1/2

11-761-09-07

9,5 cm / 3 5/8"



1/2

Jaboma

11-765-18-07

18 cm / 7 1/8"

für Lippen-, Kiefer-, Gaumenspalte

for Cleft Palate

para fisura paladar

pour fente du palais

per cheilo-labbro-palato schisi



1/2

Jaboma

11-767-18-07

18 cm / 7 1/8"

für Lippen-, Kiefer-, Gaumenspalte

for Cleft Palate

para fisura paladar

pour fente du palais

per cheilo-labbro-palato schisi



1/2

Jaboma

11-769-18-07

18 cm / 7 1/8"

für Lippen-, Kiefer-, Gaumenspalte

for Cleft Palate

para fisura paladar

pour fente du palais

per cheilo-labbro-palato schisi

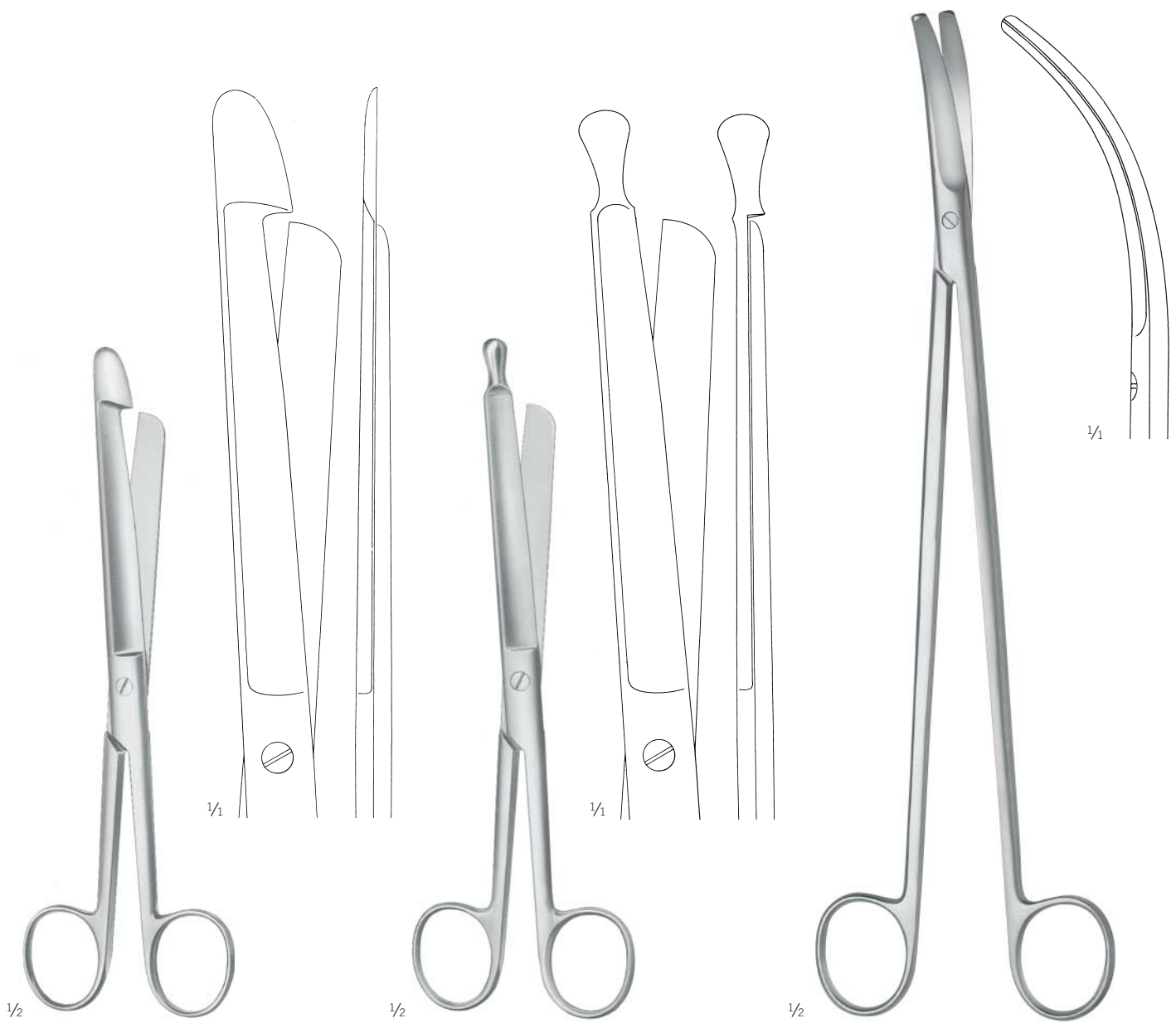
## Darmscheren

Enterotomy Scissors

Tijeras para intestino

Ciseaux-entérotomes

Forbici per enterotomia



11-782-21-07  
21,5 cm / 8 4/8"

11-784-21-07  
21,5 cm / 8 4/8"

11-785-32-07  
32,5 cm / 12 6/8"  
Rektumschere  
Rectal Scissors  
Tijera para recto  
Ciseaux pour rectum  
Forbici per il retto



## Präparierscheren, Face-lift-Scheren, Fadenscheren

Dissecting Scissors, Face-lift Scissors, Stitch Scissors

Tijeras de disección, Tijeras para Face-Lift, Tijeras para hilos

Ciseaux à dissection, Ciseaux pour Face-lift, Ciseaux à ligatures

Forbici per dissezione, Forbici per Face-lift, Forbici per legature

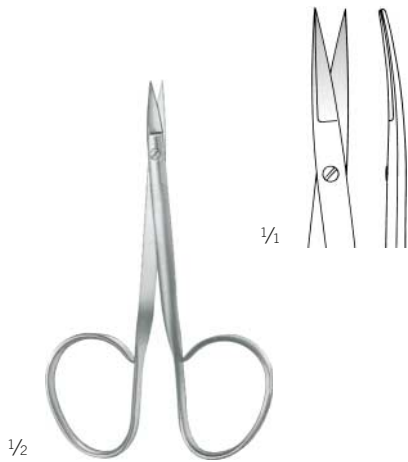
## Scheren

Scissors

Tijeras

Ciseaux

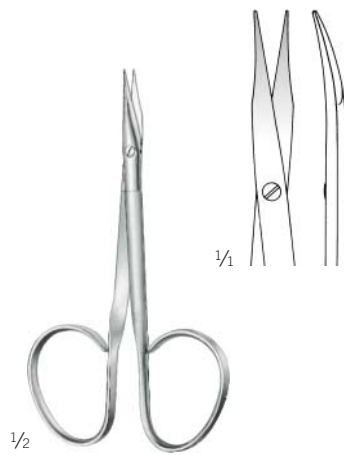
Forbici



Salyer  
11-784-09-07

9,5 cm / 3 5/8"

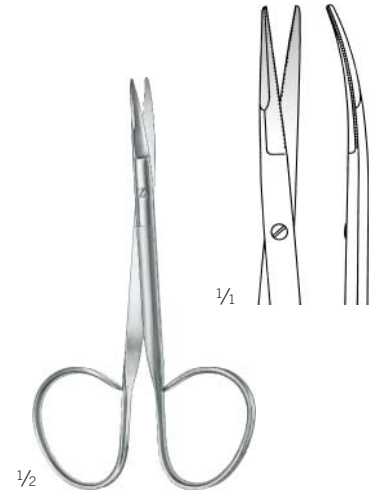
für Lippen-, Kiefer-, Gaumenspalte  
for Cleft Palate  
para fisura paladar  
pour fente du palais  
per cheilo-labbro-palato schisi



Salyer  
11-801-10-07

10 cm / 3 7/8"

für Lippen-, Kiefer-, Gaumenspalte  
for Cleft Palate  
para fisura paladar  
pour fente du palais  
per cheilo-labbro-palato schisi



Kaye  
11-809-11-07

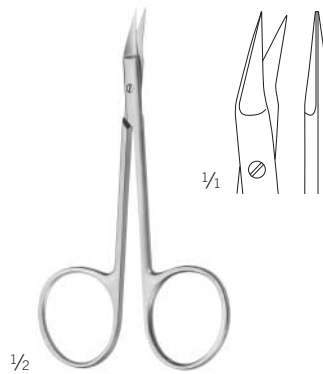
11 cm / 4 3/8"

beide Schneiden gezahnt  
both cutting edges serrated  
ambos filos dentados  
deux lames dentées  
entrambe le lame dentate



Northbent  
11-819-13-07

13 cm / 5 1/8"



O'Brian  
11-821-09-07

9 cm / 3 4/8"

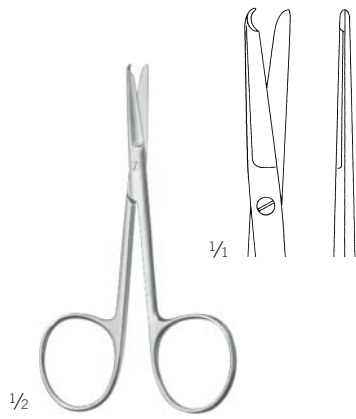
## Fadenscheren

Stitch Scissors

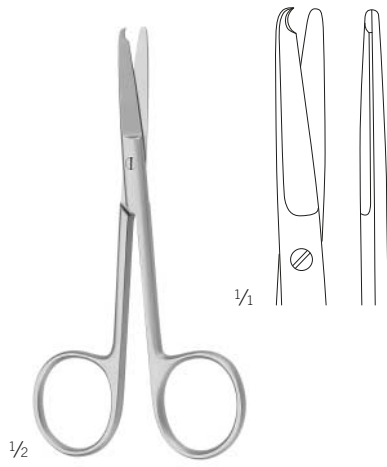
Tijeras para hilos

Ciseaux à ligatures

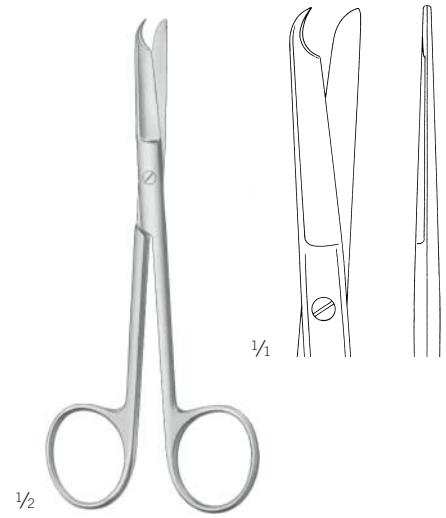
Forbici per legature



Spencer  
11-824-09-07  
9 cm / 3 1/8"



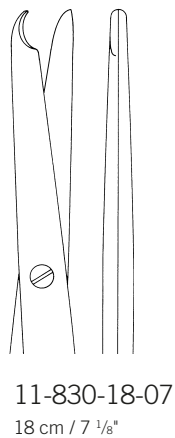
Spencer  
11-824-10-07  
10,5 cm / 4 1/8"



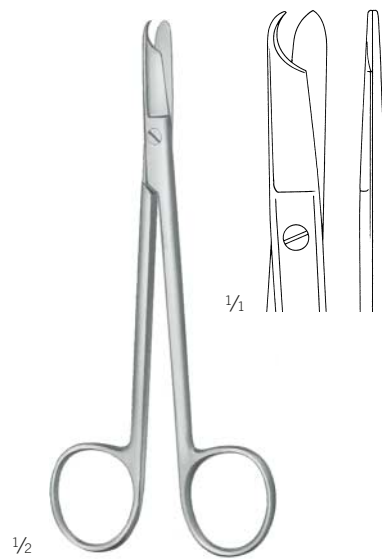
Spencer  
11-826-13-07  
13 cm / 5 1/8"



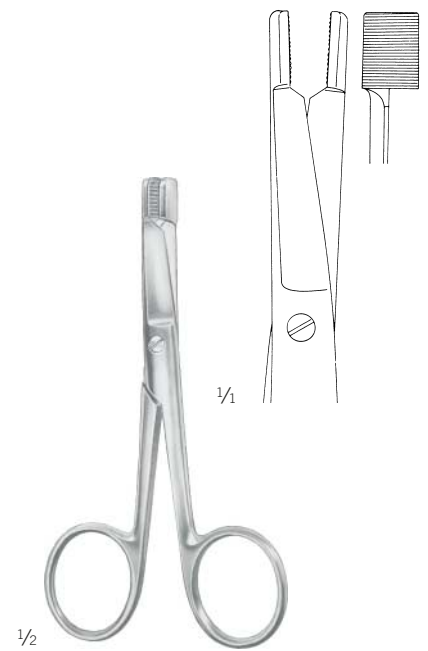
Buck  
11-830-14-07 -  
11-830-18-07



11-830-18-07  
18 cm / 7 1/8"



Littauer  
11-834-14-07  
14 cm / 5 1/8"



Eiselsberg  
11-840-12-07  
12 cm / 4 6/8"

## Drahtscheren

Wire Cutting Scissors  
Tijeras para cortar hilos de acero  
Ciseaux coupe-fil  
Forbici per tagliare fili metallici

## Scheren

Scissors  
Tijeras  
Ciseaux  
Forbici



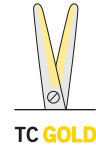
1/2

Universal  
11-865-12-07



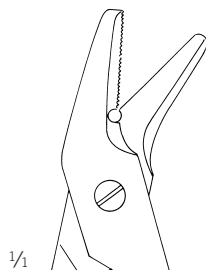
1/2

Universal  
11-995-12-07



TC GOLD

|                | Standard  | TC GOLD   |
|----------------|---|---|
| 12 cm / 4 5/8" | 11-865-12-07  | 11-995-12-07  |
|                | max Ø = 0,4 mm<br>weicher Draht<br>soft wire<br>alambre blando<br>fil métallique souple<br>filo morbido | max Ø = 1,0 mm<br>weicher Draht<br>soft wire<br>alambre blando<br>fil métallique souple<br>filo morbido |
|                |   | max Ø = 0,5 mm<br>harter Draht<br>hard wire<br>alambre duro<br>fil métallique raide<br>filo rigido      |



1/1

eine Schneide gezahnt  
one toothed cutting edge  
una hoja dentada  
une lame dentelée  
una lama dentata

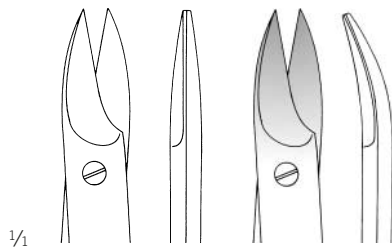
## Drahtscheren

Wire Cutting Scissors

Tijeras para cortar hilos de acero

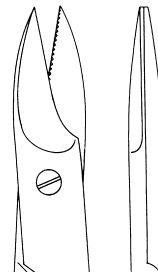
Ciseaux coupe-fil

Forbici per tagliare fili metallici



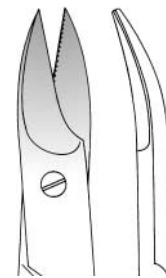
11-874-10-07  
10 cm / 3 7/8"

11-875-10-07  
10 cm / 3 7/8"



11-878-12-07  
12 cm / 4 6/8"

eine Schneide gezahnt  
one toothed cutting edge  
una hoja dentada  
une lame dentelée  
una lama dentata



11-879-12-07  
12 cm / 4 6/8"

eine Schneide gezahnt  
one toothed cutting edge  
una hoja dentada  
une lame dentelée  
una lama dentata

Beebee

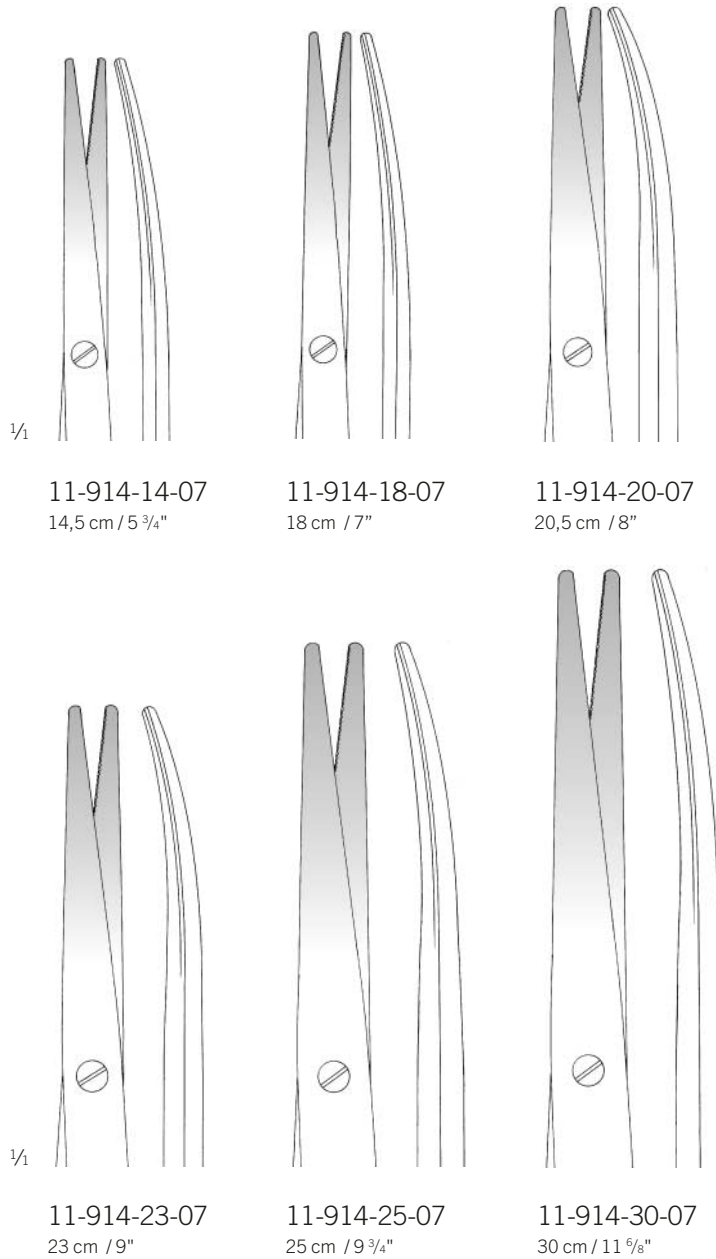
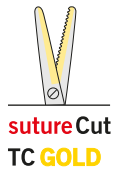
11-874-10-07 -  
11-879-12-07

## Ligaturscheren

Ligature Scissors  
Tijeras para ligaduras  
Ciseaux pour ligatures  
Forbici per legature

## Scheren

Scissors  
Tijeras  
Ciseaux  
Forbici



1/4  
11-914-14-07  
14,5 cm / 5 3/4"

11-914-18-07  
18 cm / 7"

11-914-20-07  
20,5 cm / 8"

1/4  
11-914-23-07  
23 cm / 9"

11-914-25-07  
25 cm / 9 3/4"

11-914-30-07  
30 cm / 11 5/8"

11-914-14-07 -  
11-914-30-07

für Synthetik-Nahtmaterial,  
eine Schneide gezahnt

for synthetic suture material,  
one toothed cutting edge

para hilos de sutura sintéticos,  
una hoja dentada

pour matériel de suture synthétique,  
une lame dentelée

per materiale di sutura sintetico,  
una lama dentata

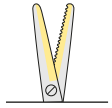
## Ligaturscheren

Ligature Scissors

Tijeras para ligaduras

Ciseaux pour ligatures

Forbici per legature



suture Cut  
TC GOLD



11-915-14-07 -  
11-915-23-07

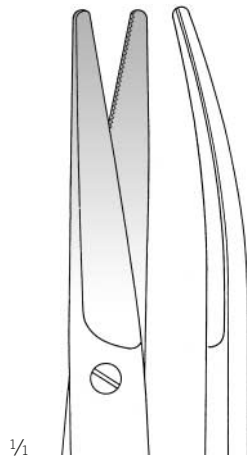
für Synthetik-Nahtmaterial,  
eine Schneide gezahnt

for synthetic suture material,  
one toothed cutting edge

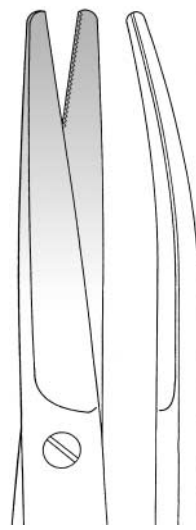
para hilos de sutura sintéticos,  
una hoja dentada

pour matériel de suture synthétique,  
une lame dentelée

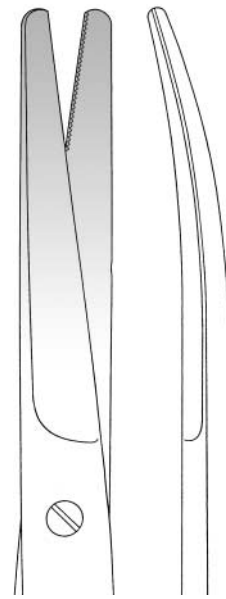
per materiale di sutura sintetico,  
una lama dentata



11-915-14-07  
14,5 cm / 5 3/4"



11-915-17-07  
17 cm / 6 3/4"



11-915-23-07  
23 cm / 9"

## TCC-BlackLine-Scheren

TCC-BlackLine Scissors

Tijeras TCC-BlackLine

Ciseaux TCC-BlackLine

Forbici TCC-BlackLine

## Scheren

Scissors

Tijeras

Ciseaux

Forbici



TCC BlackLine

finoLine TC GOLD

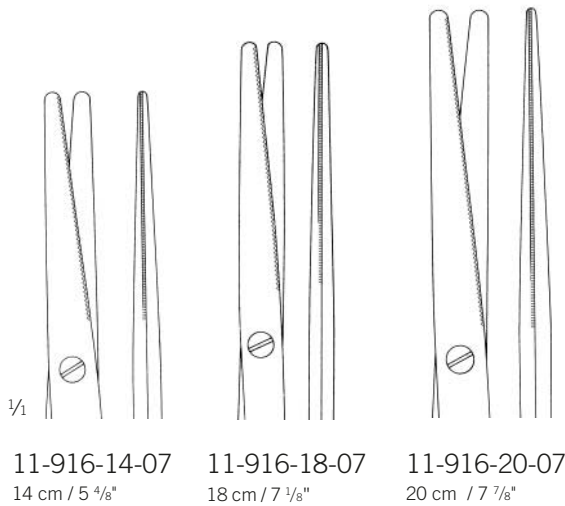


11



1/2

11-916-14-07 -  
11-916-20-07



1/1

11-916-14-07  
14 cm / 5 4/8"

11-916-18-07  
18 cm / 7 1/8"

11-916-20-07  
20 cm / 7 7/8"



1/2

Tönnis-Adson TCC-BlackLine  
11-919-14-07 -  
11-919-18-07

sehr fein  
very delicate  
muy fino  
très fin  
strafino

Keramik-Beschichtung,  
eine Schneide gezahnt

Coated with ceramics,  
one toothed cutting edge

Cubierto con material de cerámicas,  
una hoja dentada

Recouvert avec matériau de la  
céramique, une lame dentelée

Ricoprito con materiale di ceramica,  
una lama dentata

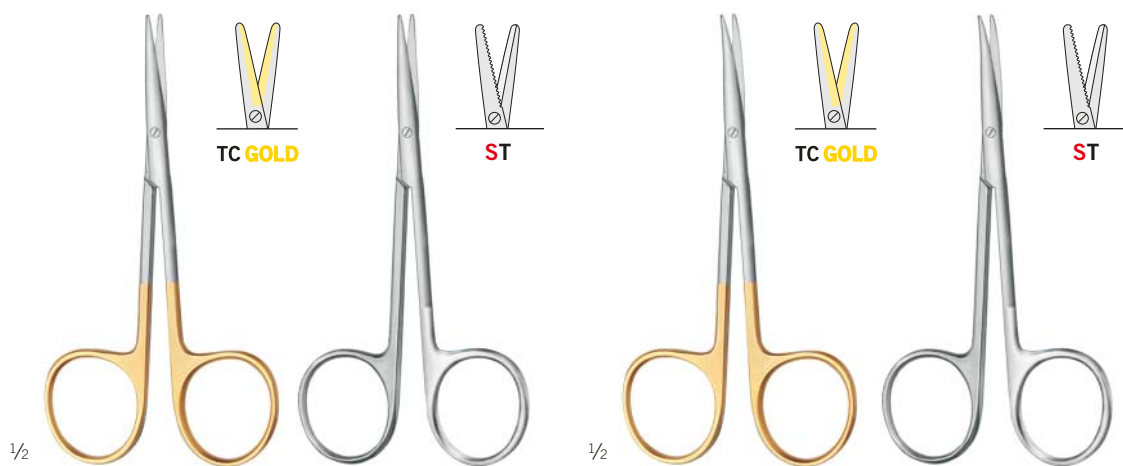
## Präparierscheren

Dissecting Scissors

Tijeras de disección

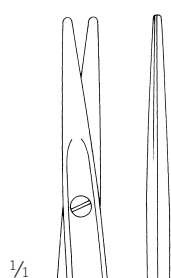
Ciseaux à dissection

Forbici per dissezione



| Knapp            | TC GOLD      | ST           |
|------------------|--------------|--------------|
| 12,5 cm / 4 7/8" | 11-934-12-07 | 28-404-12-07 |

| TC GOLD      | ST           |
|--------------|--------------|
| 11-935-12-07 | 28-405-12-07 |



12,5 cm / 4 1/8"



12,5 cm / 4 1/8"



## Präparierscheren

Dissecting Scissors  
Tijeras de disección  
Ciseaux à dissection  
Forbici per dissezione

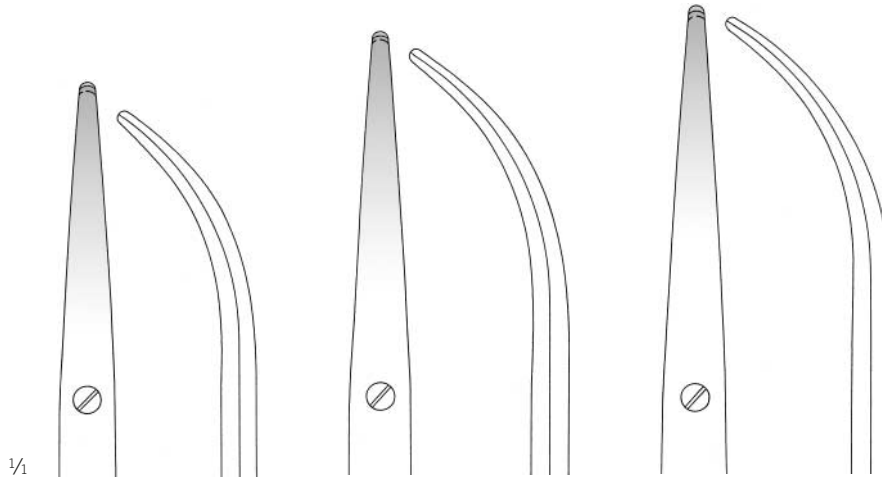
## Scheren

Scissors  
Tijeras  
Ciseaux  
Forbici



1/2

Metzenbaum-Thorek  
11-945-20-07 -  
11-945-28-07



1/4

11-945-20-07  
20 cm / 7 7/8"

11-945-23-07  
23 cm / 9"

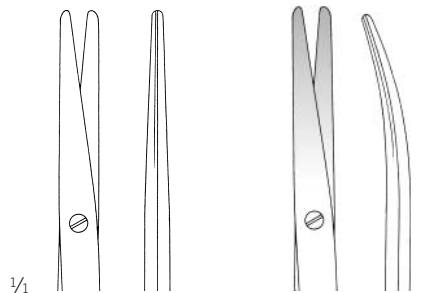
11-945-28-07  
28 cm / 11"



1/2

Lexer  
11-950-10-07 -  
11-951-10-07

10 cm / 3 7/8"



1/4

11-950-10-07

11-951-10-07

## Präparierscheren

Dissecting Scissors

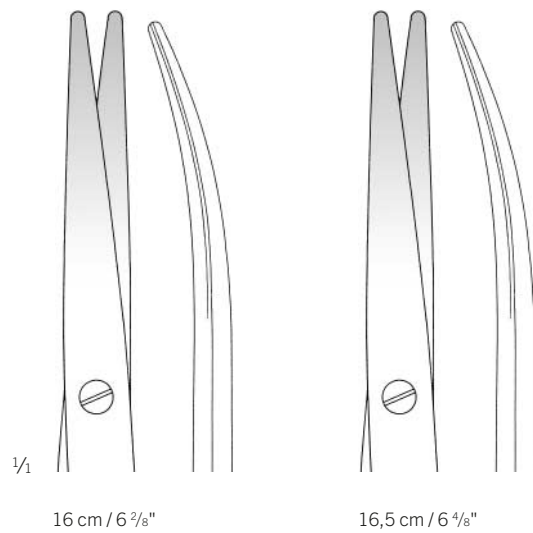
Tijeras de disección

Ciseaux à dissection

Forbici per dissezione



| Mayo-Lexer       | TC GOLD      | ST           |
|------------------|--------------|--------------|
| 16 cm / 6 2/8"   | 11-953-16-07 |              |
| 16,5 cm / 6 4/8" |              | 28-413-16-07 |



16 cm / 6 2/8"

16,5 cm / 6 4/8"

## Feine Präparierscheren

Delicate Dissecting Scissors

Tijeras finas de disección

Ciseaux fins à dissection

Forbici fini per dissezione

## Scheren

Scissors

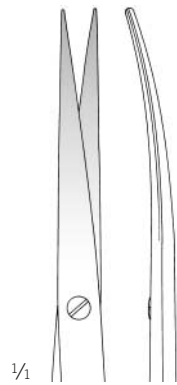
Tijeras

Ciseaux

Forbici



1/2



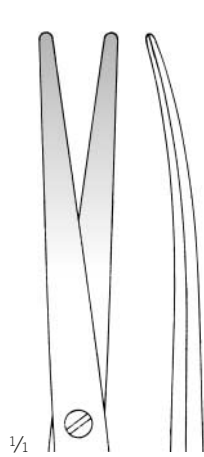
Metzenbaum-Lahey  
11-965-14-07

14,5 cm / 5 7/8"

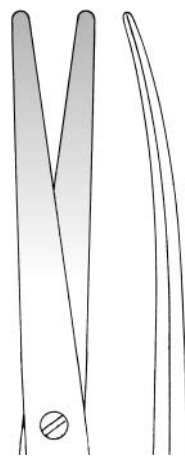
schlankes Modell  
slender pattern  
modelo delgado  
modèle gracile  
modello delicato



1/2



11-965-20-07  
20,5 cm / 8 1/8"



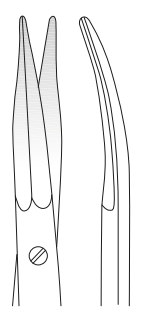
11-965-23-07  
23 cm / 9"



1/2



11-968-11-07



11-969-11-07

Metzenbaum-Fino  
11-965-20-07 -  
11-965-23-07

schlankes Modell  
slender pattern  
modelo delgado  
modèle gracile  
modello delicato

Siegert  
11-968-11-07 -  
11-969-11-07  
11,5 cm / 4 5/8"

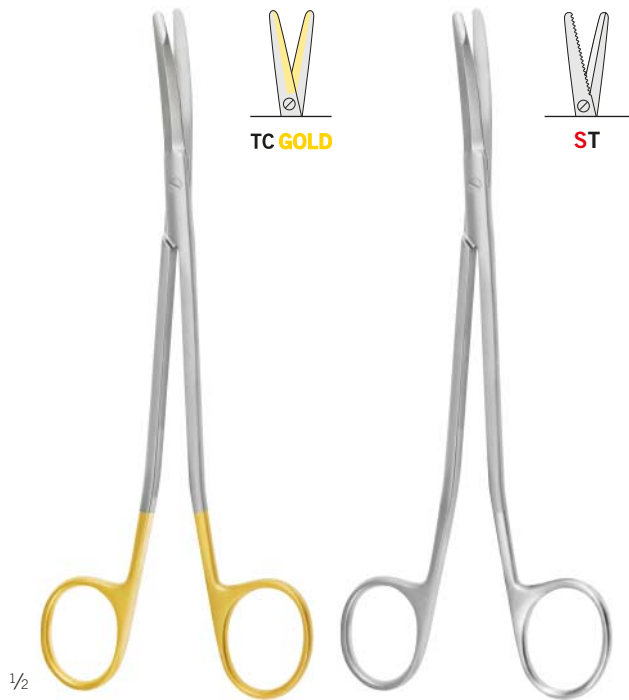
## Face-lift-Scheren

Face-lift Scissors

Tijeras para Face-Lift

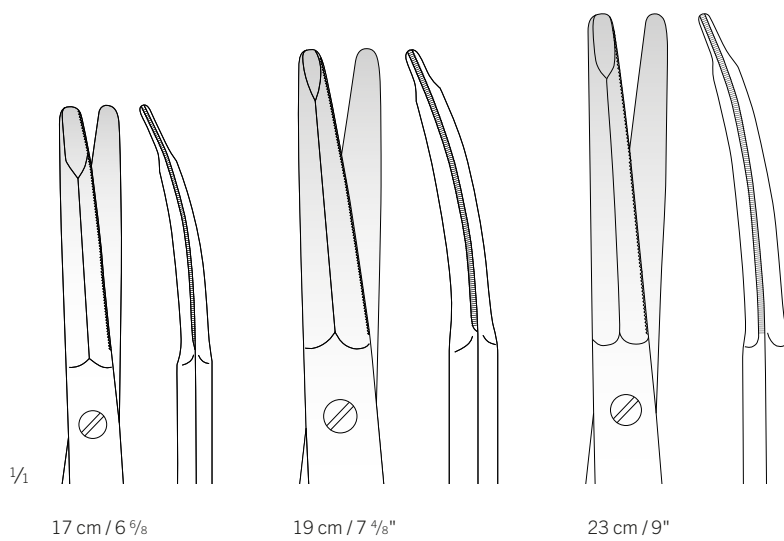
Ciseaux pour Face-lift

Forbici per Face-lift



| Gorney-Freeman | TC GOLD      | ST           |
|----------------|--------------|--------------|
| 17 cm / 6 5/8" | 11-969-17-07 | 28-445-17-07 |
| 19 cm / 7 1/2" | 11-969-19-07 |              |
| 23 cm / 9"     | 11-969-23-07 |              |

eine Schneide gezahnt  
 one toothed cutting edge  
 una hoja dentada  
 une lame dentelée  
 una lama dentata



17 cm / 6 5/8"

19 cm / 7 1/2"

23 cm / 9"

## Face-lift-Scheren

Face-lift Scissors

Tijeras para Face-Lift

Ciseaux pour Face-lift

Forbici per Face-lift

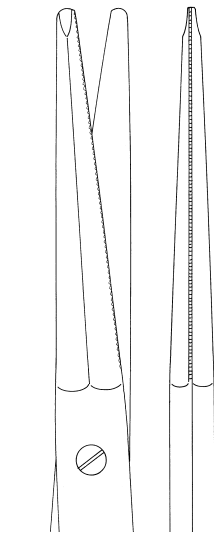
## Scheren

Scissors

Tijeras

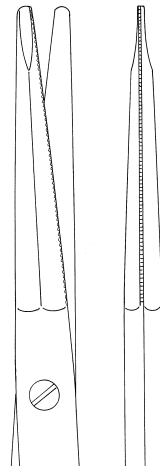
Ciseaux

Forbici

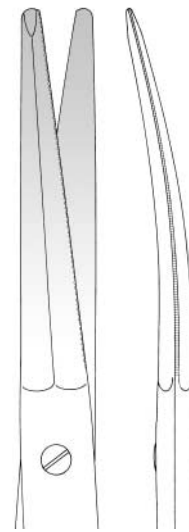


1/1

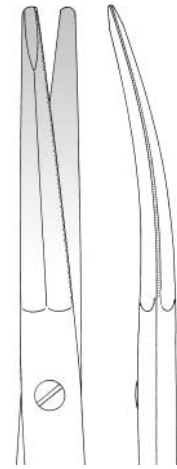
11-970-19-07  
20 cm / 7 7/8"



11-970-23-07  
23 cm / 9"



11-971-19-07  
20 cm / 7 7/8"



11-971-23-07  
23 cm / 9"

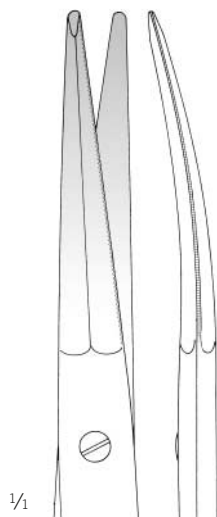
11

Gorney

11-970-19-07 -

11-971-23-07

eine Schneide gezahnt  
one toothed cutting edge  
una hoja dentada  
une lame dentelée  
una lama dentata



1/1

Rees

11-973-17-07

17 cm / 6 5/8"

eine Schneide gezahnt  
one toothed cutting edge  
una hoja dentada  
une lame dentelée  
una lama dentata

# Uterusscheren

Uterine Scissors

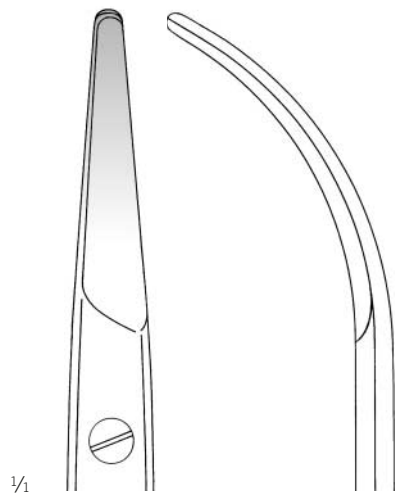
Tijeras uterinas

Ciseaux utérins

Forbici uterine



|                | TC GOLD      | AQUILA       |
|----------------|--------------|--------------|
| 22 cm / 8 5/8" | 11-979-22-07 | 11-989-22-07 |




## Uterusscheren

Uterine Scissors  
Tijeras uterinas  
Ciseaux utérins  
Forbici uterine

## Scheren

Scissors  
Tijeras  
Ciseaux  
Forbici



|            | <b>TC GOLD</b> |  <b>AQUILA</b> |
|------------|----------------|---|
| 23 cm / 9" | 11-979-23-07   | 11-989-23-07  |



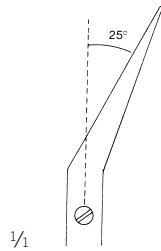
## Winkelscheren

Angled Scissors

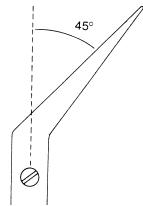
Tijeras acodadas

Ciseaux coudés

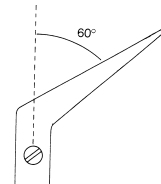
Forbici angolate



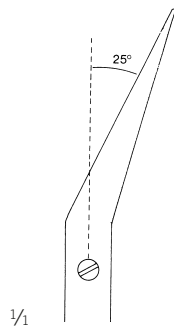
11-985-25-07  
19 cm / 7 <sup>4</sup>/<sub>8</sub>"



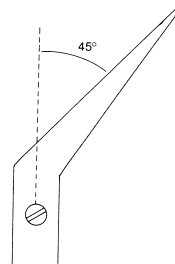
11-985-45-07  
18,5 cm / 7 <sup>2</sup>/<sub>8</sub>"



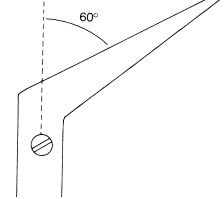
11-985-60-07  
18 cm / 7 <sup>1</sup>/<sub>8</sub>"



11-987-25-07  
23 cm / 9"



11-987-45-07  
23 cm / 9"



11-987-60-07  
22 cm / 8 <sup>5</sup>/<sub>8</sub>"



1/2

De Bakey  
11-985-25-07 -  
11-987-60-07



## Präparierscheren

Dissecting Scissors  
Tijeras de disección  
Ciseaux à dissection  
Forbici per dissezione

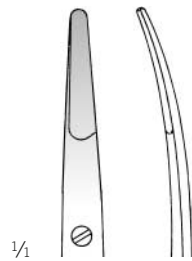
## Scheren

Scissors  
Tijeras  
Ciseaux  
Forbici



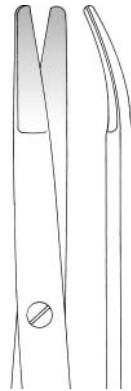
1/2

Ragnell  
11-991-12-07-  
11-991-18-07

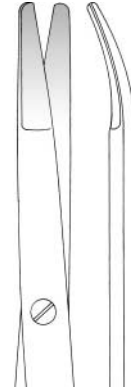


1/4

11-991-12-07  
12,5 cm / 4 7/8"



11-991-15-07  
15 cm / 5 7/8"



11-991-18-07  
18 cm / 7 1/8"

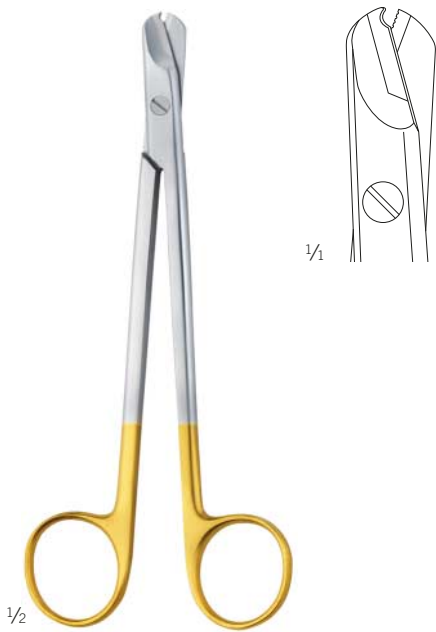
## Drahtscheren

Wire Cutting Scissors

Tijeras para cortar hilos de acero

Ciseaux coupe-fil

Forbici per tagliare fili metallici



Martin  
11-996-16-07

16 cm / 6 2/8"

Drahtschere  
Wire cutting scissors  
Tijera para alambre  
Ciseaux à fils  
Forbici per fili

max Ø = 0,5 mm  
weicher Draht  
hard wire  
alambre duro  
fil métallique raide  
filo rigido


Pinzetten  
Forceps  
Pinzas  
Pinces  
Pinze

# 12






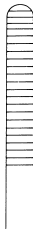
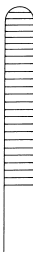

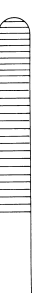
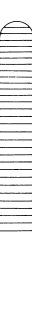


# Anatomische Pinzetten


Dissecting Forceps  
 Pinzas de disección  
 Pinces à dissection  
 Pinze per dissezione








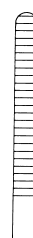


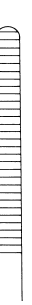
1/2

|     |  |  |  |  |  |
|-----|--|--|--|--|--|
| 1/1 |   |   |   |   |   |
|     | 12-100-10-07<br>10,5 cm / 4 1/8"   | 12-100-11-07<br>11,5 cm / 4 7/8"   | 12-100-13-07<br>13 cm / 5 1/8"   | 12-100-14-07<br>14,5 cm / 5 7/8"   | 12-100-16-07<br>16 cm / 6 2/8"   |
| 1/1 |  |  |  |  |  |
|     | 12-100-18-07<br>18 cm / 7 1/8"   | 12-100-20-07<br>20 cm / 7 7/8"   | 12-100-23-07<br>23 cm / 9"   | 12-100-25-07<br>25 cm / 9 7/8"   | 12-100-30-07<br>30,5 cm / 12"  |

12-100-10-07 -  
12-100-30-07  
 Standardmodell  
 standard pattern  
 modelo estándar  
 modèle standard  
 modello standard



1/2

|     |   |   |   |   |   |
|-----|---|---|---|---|---|
| 1/1 |  |  |  |  |  |
|     | 12-120-11-07<br>12 cm / 4 5/8"  | 12-120-13-07<br>13 cm / 5 1/8"  | 12-120-14-07<br>14,5 cm / 5 5/8"  | 12-120-16-07<br>16 cm / 6 2/8"  | 12-120-18-07<br>18 cm / 7 1/8"  |
| 1/1 |  |  |  |  |   |
|     | 12-120-20-07<br>20 cm / 7 7/8"  | 12-120-23-07<br>23 cm / 9"  | 12-120-25-07<br>25 cm / 9 7/8"  | 12-120-30-07<br>30 cm / 11 5/8"   |   |

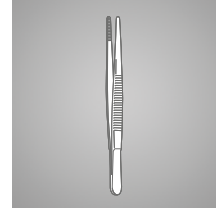
12-120-11-07 -  
12-120-30-07  
 mittelbreit  
 medium width  
 de anchura medio  
 demi-large  
 di media larghezza

# Anatomische Pinzetten

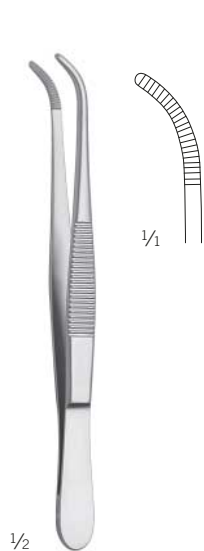
Dissecting Forceps  
 Pinzas de disección  
 Pincés à dissection  
 Pinze per dissezione

# Pinzetten

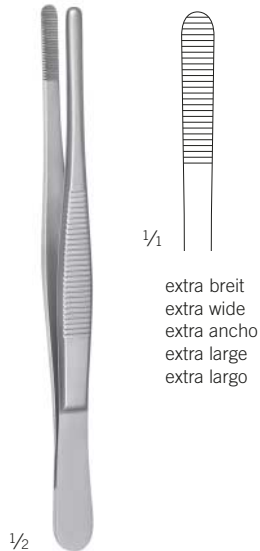
Forceps  
 Pinzas  
 Pincés  
 Pinze



12



12-122-13-07  
 13 cm / 5 1/8"



12-123-15-07  
 14,5 cm / 5 6/8"

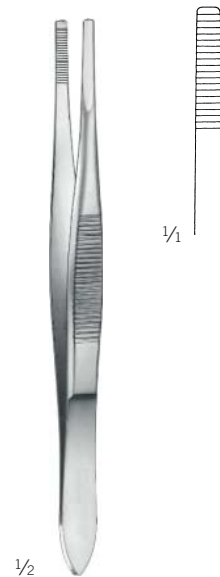
extra breit  
 extra wide  
 extra ancho  
 extra large  
 extra largo



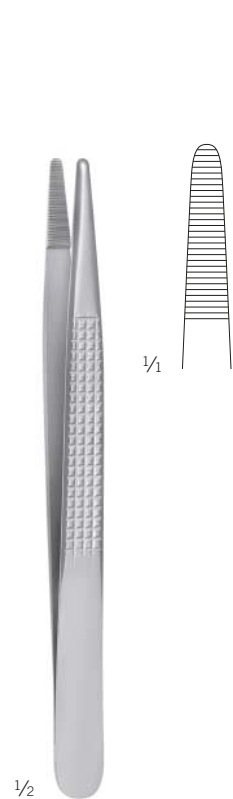
12-126-13-07  
 13 cm / 5 1/8"



12-126-14-07  
 14,5 cm / 5 6/8"



Stille  
 12-130-15-07  
 15 cm / 5 7/8"



Bonney  
 12-131-17-07  
 17 cm / 6 5/8"



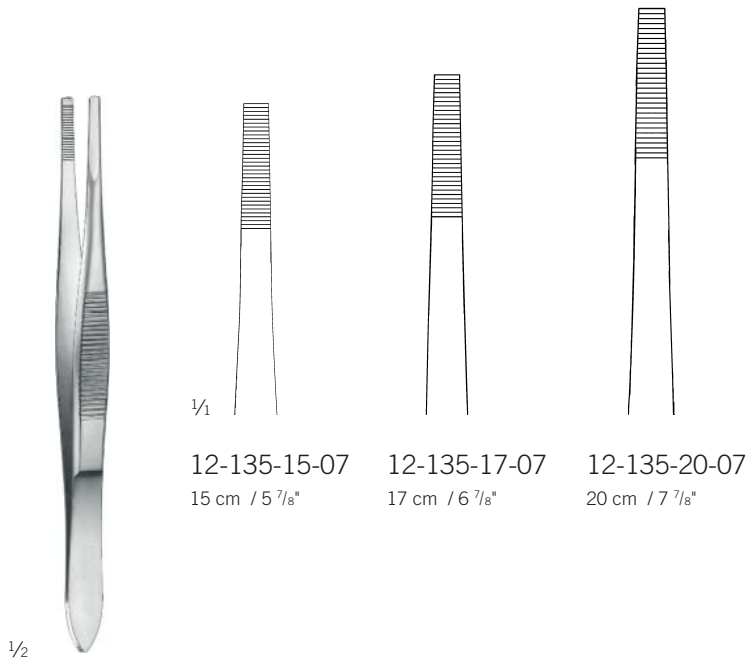
12-132-19-07  
 18,5 cm / 7 2/8"



12-134-20-07  
 20 cm / 7 7/8"

# Anatomische Pinzetten

Dissecting Forceps  
 Pinzas de disección  
 Pinces à dissection  
 Pinze per dissezione

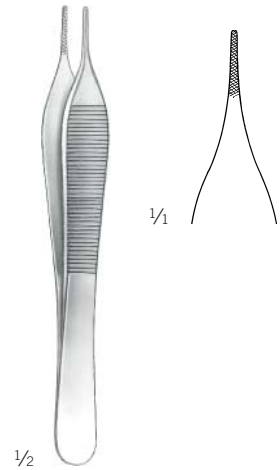


12-135-15-07  
 15 cm / 5 7/8"

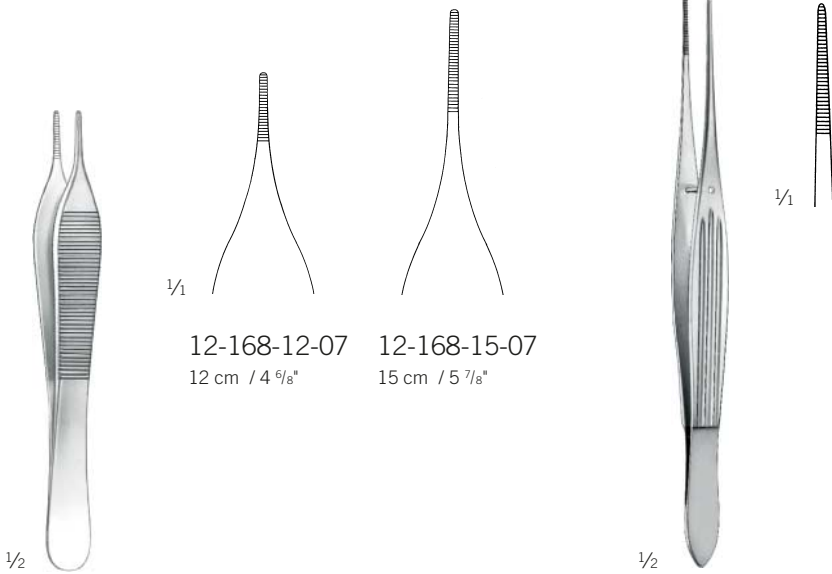
12-135-17-07  
 17 cm / 6 7/8"

12-135-20-07  
 20 cm / 7 7/8"

Schweden-Modell  
 12-135-15-07 -  
 12-135-20-07



Mini-Adson  
 12-166-12-07  
 12 cm / 4 6/8"



12-168-12-07  
 12 cm / 4 6/8"

12-168-15-07  
 15 cm / 5 7/8"

McIndoe  
 12-170-15-07  
 15 cm / 5 7/8"

Adson  
 12-168-12-07 -  
 12-168-15-07



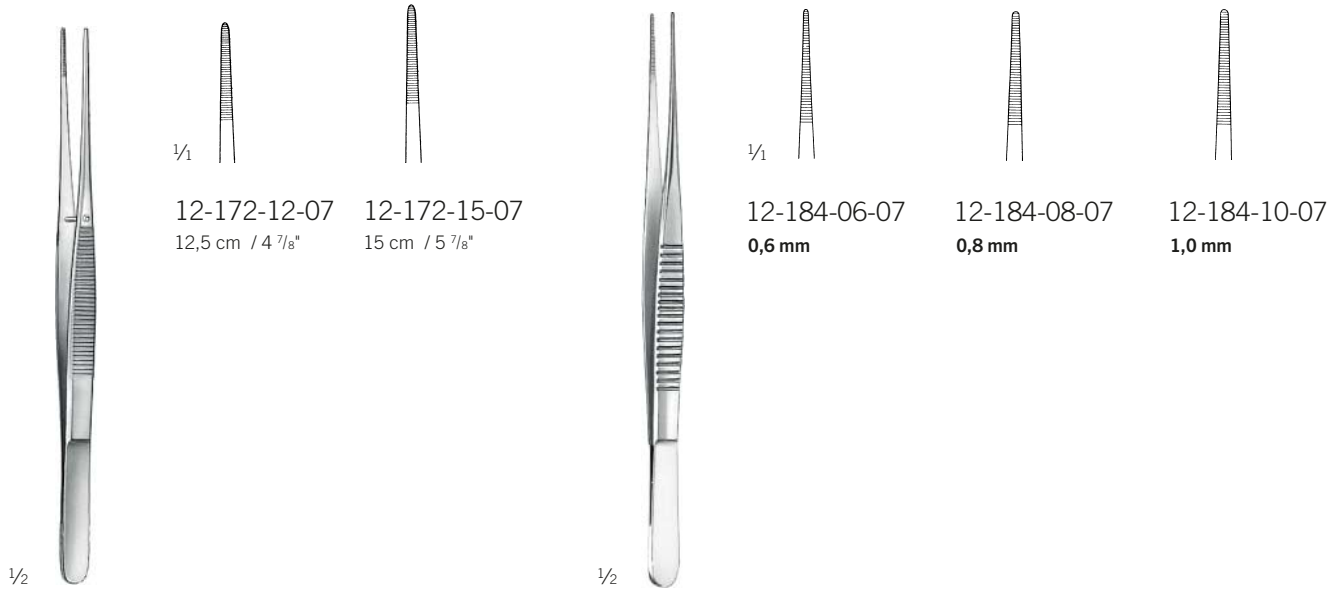
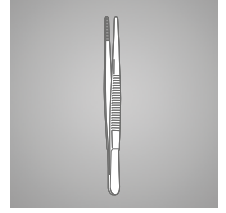
Waugh  
 12-171-20-07  
 20 cm / 7 7/8"

## Anatomische Pinzetten

Dissecting Forceps  
Pinzas de disección  
Pincès à dissection  
Pinze per dissezione

## Pinzetten

Forceps  
Pinzas  
Pincès  
Pinze



12-172-12-07  
12,5 cm / 4 <sup>7</sup>/<sub>8</sub>"

12-172-15-07  
15 cm / 5 <sup>7</sup>/<sub>8</sub>"

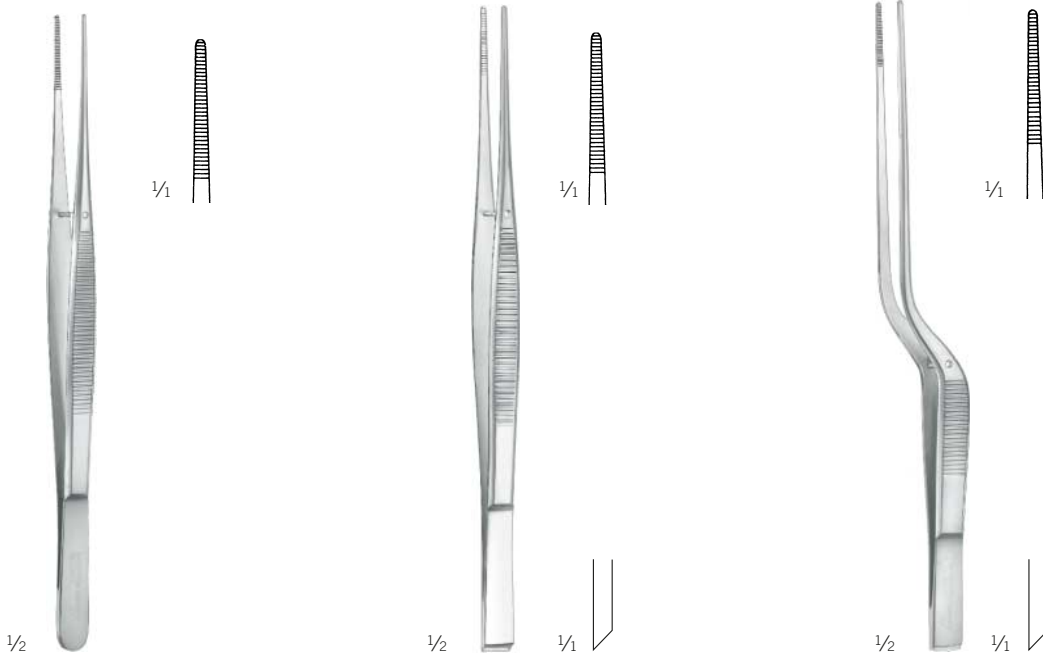
12-184-06-07  
0,6 mm

12-184-08-07  
0,8 mm

12-184-10-07  
1,0 mm

Semken  
12-172-12-07 -  
12-172-15-07

12-184-06-07 -  
12-184-10-07  
15,5 cm / 6 <sup>1</sup>/<sub>8</sub>"



Taylor  
12-174-17-07  
17 cm / 6 <sup>6</sup>/<sub>8</sub>"

Taylor  
12-180-17-07  
17,5 cm / 6 <sup>7</sup>/<sub>8</sub>"  
mit Schaberende  
with dissector end  
con rascador  
à rugine  
con estremita a forma di raschino

Taylor  
12-183-17-07  
18,5 cm / 7 <sup>2</sup>/<sub>8</sub>"  
mit Schaberende  
with dissector end  
con rascador  
à rugine  
con estremita a forma di raschino

12

# Anatomische Pinzetten

Dissecting Forceps  
 Pinzas de disección  
 Pincès à dissection  
 Pinze per dissezione

## Atrauma



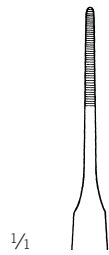
12-184-18-07  
 17,5 cm / 6 7/8"



1/2

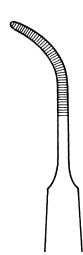


Gerald  
 12-186-18-07 -  
 12-187-18-07



1/2

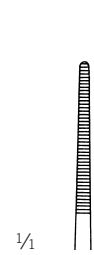
12-186-18-07  
 17,5 cm / 6 7/8"



12-187-18-07  
 17 cm / 6 6/8"

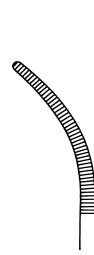


Cushing  
 12-188-17-07 -  
 12-189-17-07



1/2

12-188-17-07  
 17,5 cm / 6 7/8"



12-189-17-07  
 17 cm / 6 6/8"

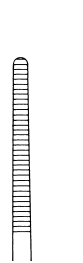


Potts-Smith  
 12-192-18-07 -  
 12-192-30-07

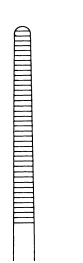


1/2

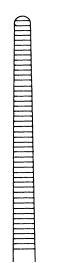
12-192-18-07  
 18 cm / 7 1/8"



12-192-21-07  
 21 cm / 8 2/8"



12-192-25-07  
 25 cm / 9 7/8"



12-192-30-07  
 30 cm / 11 6/8"



# Chirurgische Pinzetten, Anatomische Pinzetten

Tissue Forceps, Dissecting Forceps

Pinzas de disección con diente, Pinzas de disección

Pinces à dissection à griffes, Pinces à dissection

Pinze per dissezione con denti, Pinze per dissezione

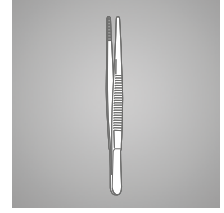
# Pinzetten

Forceps

Pinzas

Pinces

Pinze



## TC GOLD

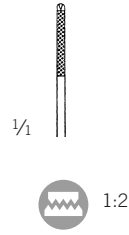


1/2

**Bonney**  
12-230-17-07

17,5 cm / 6 7/8"

Normalprofil  
standard profile  
perfil estándar  
profil normal  
profilo normale

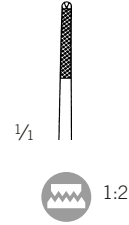


1/2

**Gerald**  
12-234-17-07

17,5 cm / 6 7/8"

Normalprofil  
standard profile  
perfil estándar  
profil normal  
profilo normale



1/2

**Gillies**  
12-236-15-07

15,5 cm / 6 1/8"

Miniprofil  
mini profile  
perfil mini  
profil mini  
mini-profilo



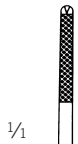
1/2

**McIndoe**  
12-238-15-07

15 cm / 5 7/8"

Miniprofil  
mini profile  
perfil mini  
profil mini  
mini-profilo

12



1/2

**Semken**  
12-240-16-07 -  
12-242-18-07

12-240-16-07

15,5 cm / 6 1/8"

Normalprofil  
normal profile  
perfil normal  
profil normal  
profilo normale



12-240-18-07

17,5 cm / 6 7/8"

Normalprofil  
normal profile  
perfil normal  
profil normal  
profilo normale



12-242-16-07

15,5 cm / 6 1/8"

Miniprofil  
mini profile  
perfil mini  
profil mini  
mini-profilo



12-242-18-07

17,5 cm / 6 7/8"

Miniprofil  
mini profile  
perfil mini  
profil mini  
mini-profilo



# Chirurgische Pinzetten, Anatomische Pinzetten

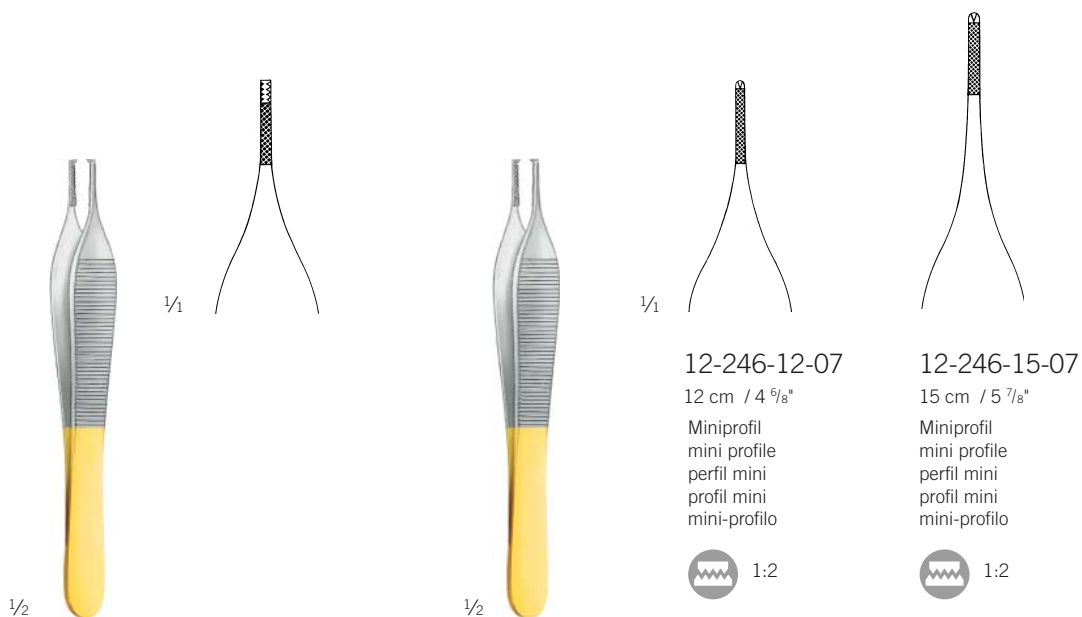
Tissue Forceps, Dissecting Forceps

Pinzas de disección con diente, Pinzas de disección

Pinces à dissection à griffes, Pinces à dissection

Pinze per dissezione con denti, Pinze per dissezione

## TC GOLD



Adson-Brown  
12-244-12-07

12 cm / 4 5/8"

Normalprofil  
normal profile  
perfil normal  
profil normal  
profilo normale

Adson  
12-246-12-07 -  
12-246-15-07

12-246-12-07

12 cm / 4 5/8"

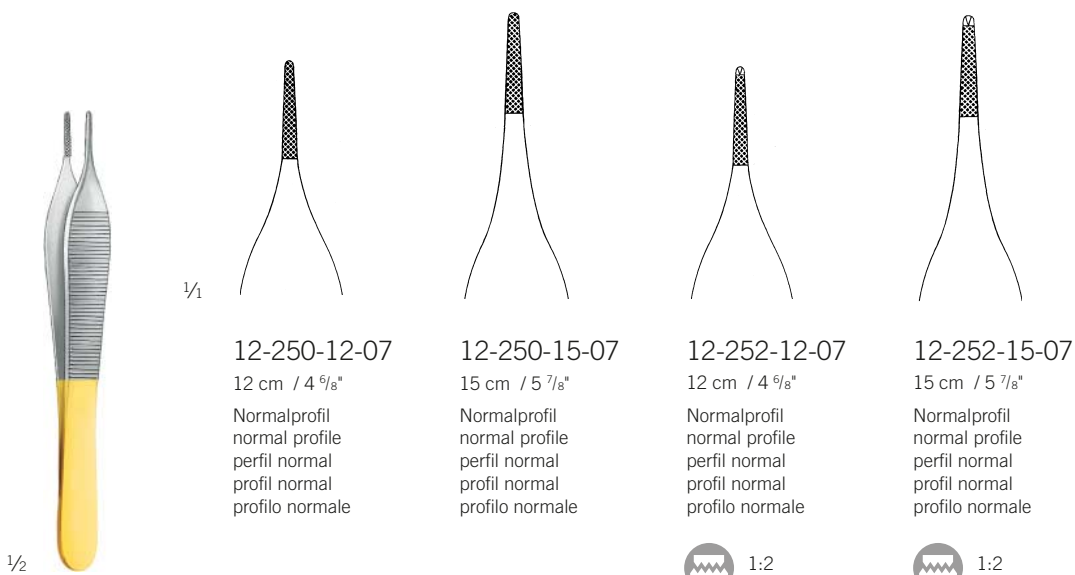
Miniprofil  
mini profile  
perfil mini  
profil mini  
mini-profilo



12-246-15-07

15 cm / 5 7/8"

Miniprofil  
mini profile  
perfil mini  
profil mini  
mini-profilo



Adson  
12-250-12-07 -  
12-252-15-07

12-250-12-07

12 cm / 4 5/8"

Normalprofil  
normal profile  
perfil normal  
profil normal  
profilo normale

12-250-15-07

15 cm / 5 7/8"

Normalprofil  
normal profile  
perfil normal  
profil normal  
profilo normale

12-252-12-07

12 cm / 4 5/8"

Normalprofil  
normal profile  
perfil normal  
profil normal  
profilo normale

12-252-15-07

15 cm / 5 7/8"

Normalprofil  
normal profile  
perfil normal  
profil normal  
profilo normale

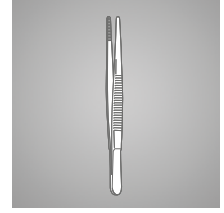


# Anatomische Pinzetten

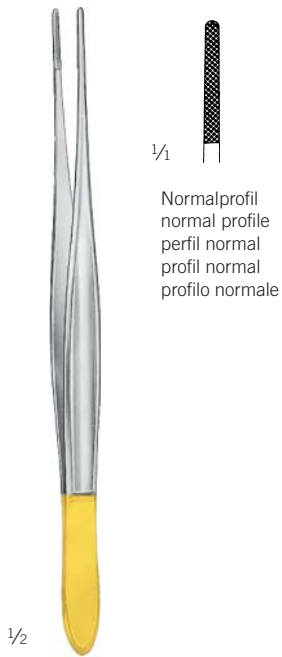
Dissecting Forceps  
Pinzas de disección  
Pincés à dissection  
Pinze per dissezione

# Pinzetten

Forceps  
Pinzas  
Pincés  
Pinze



## TC GOLD



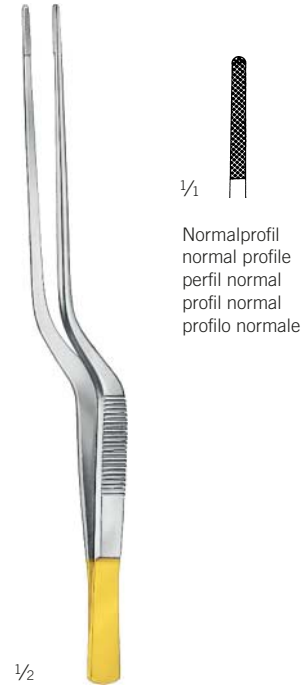
Normalprofil  
normal profile  
perfil normal  
profil normal  
profilo normale

Cushing  
12-254-17-07  
17,5 cm / 6 7/8"



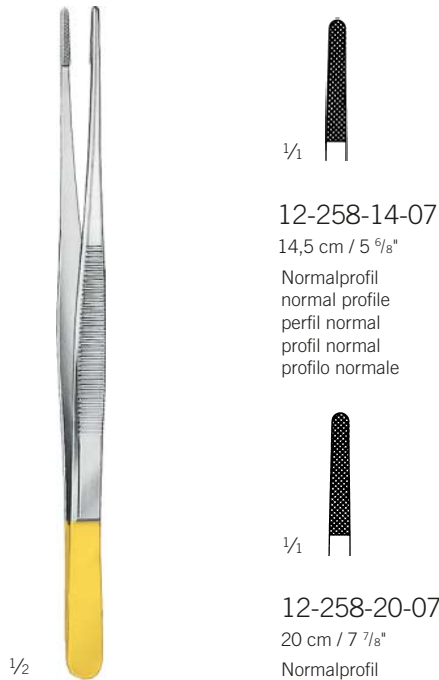
Normalprofil  
normal profile  
perfil normal  
profil normal  
profilo normale

Cushing  
12-255-18-07  
17 cm / 6 6/8"



Normalprofil  
normal profile  
perfil normal  
profil normal  
profilo normale

Cushing-Taylor  
12-256-18-07  
18,5 cm / 7 2/8"



Potts-Smith  
12-258-14-07 -  
12-258-25-07



12

# Chirurgische Pinzetten, Anatomische Pinzetten

Tissue Forceps, Dissecting Forceps

Pinzas de disección con diente, Pinzas de disección

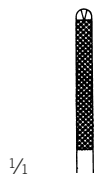
Pinces à dissection à griffes, Pinces à dissection

Pinze per dissezione con denti, Pinze per dissezione

## TC GOLD



1/2



1/1

12-260-14-07

14,5 cm / 5 5/8"

Normalprofil  
normal profile  
perfil normal  
profil normal  
profilo normale



1:2



1:2

12-260-16-07

16 cm / 6 2/8"

Normalprofil  
normal profile  
perfil normal  
profil normal  
profilo normale



1:2

12-260-18-07

18 cm / 7 1/8"

Normalprofil  
normal profile  
perfil normal  
profil normal  
profilo normale



1:2

12-260-20-07

20 cm / 7 7/8"

Normalprofil  
normal profile  
perfil normal  
profil normal  
profilo normale



1:2

12-260-25-07

25 cm / 9 7/8"

Normalprofil  
normal profile  
perfil normal  
profil normal  
profilo normale

Oehler

12-260-14-07 -

12-260-25-07



1/2



1/1

12-266-15-07

15 cm / 5 7/8"

Normalprofil  
normal profile  
perfil normal  
profil normal  
profilo normale



1/1

12-266-23-07

23 cm / 9"

Normalprofil  
normal profile  
perfil normal  
profil normal  
profilo normale

Wangenstein

12-266-15-07 -

12-266-23-07



1/1



1/2

Kübler

12-267-20-07

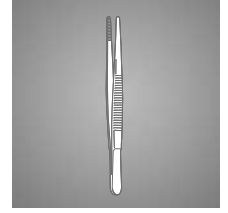
20 cm / 7"

# Anatomische Pinzetten

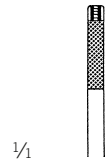
Dissecting Forceps  
Pinzas de disección  
Pincés à dissection  
Pinze per dissezione

# Pinzetten

Forceps  
Pinzas  
Pincés  
Pinze



## TC GOLD Atrauma



|                  |  |
|------------------|--|
|                  | Miniprofil<br>mini profile<br>perfil mini<br>profil mini<br>mini-profilo |
|                  | <b>2,0 mm</b>  |
| 16 cm / 6 2/8"   | 12-272-15-07   |
| 20 cm / 7 7/8"   | 12-272-19-07   |
| 24,5 cm / 9 5/8" | 12-272-24-07   |

1/2

DeBakey  
12-272-15-07 -  
12-272-24-07



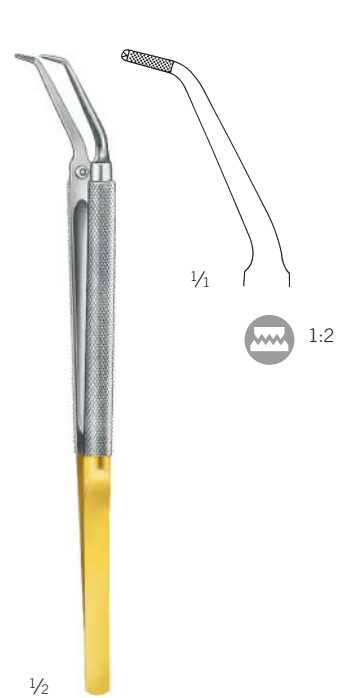
1/2

Jaboma  
12-276-18-07  
18 cm / 7 1/8"



1/2

Jaboma  
12-278-18-07  
18 cm / 7 1/8"



1/2

Jaboma  
12-279-18-07  
18 cm / 7 1/8"

## Anatomische Pinzetten, Atraumatische Pinzetten

Dissecting Forceps, Atraumatic Dissecting Forceps

Pinzas de disección, Pinzas de disección atraumática

Pinces à dissection, Pinces atraumatiques à dissection

Pinze per dissezione, Pinze atraumatiche

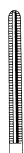


1/2

### Atrauma



1/1



|                  | 1,5 mm       | 1,8 mm       |
|------------------|--------------|--------------|
| 16 cm / 6 2/8"   | 12-282-16-09 | 12-284-16-09 |
| 20,5 cm / 8 1/8" | 12-282-20-09 | 12-284-20-09 |
| 24,5 cm / 9 5/8" | 12-282-24-09 | 12-284-24-09 |

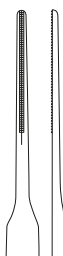
DeBakey  
12-282-16-09 -  
12-284-24-09



1/2



1/1



|                | Atrauma         | diamond      | diamond      |
|----------------|-----------------|--------------|--------------|
|                | Ø 1,2 mm        | 1,0 x 0,5 mm | 1,0 mm       |
| 18 cm / 7 1/8" | St 12-285-18-07 | 12-286-18-07 | 12-287-18-07 |
| 20 cm / 7 7/8" | St 12-285-20-07 | 12-286-20-07 | 12-287-20-07 |

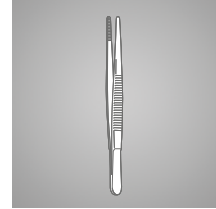
Gerald  
12-285-18-07 -  
12-287-20-07

# Chirurgische Pinzetten

Tissue Forceps  
 Pinzas de disección con diente  
 Pincès à dissection à griffes  
 Pinze per dissezione con denti

# Pinzetten

Forceps  
 Pinzas  
 Pincès  
 Pinze



1/1

|                                  |                                |                                |                                  |                                |
|----------------------------------|--------------------------------|--------------------------------|----------------------------------|--------------------------------|
|                                  |                                |                                |                                  |                                |
| 12-301-10-07<br>10,5 cm / 4 1/8" | 12-301-11-07<br>12 cm / 4 7/8" | 12-301-13-07<br>13 cm / 5 1/8" | 12-301-14-07<br>14,5 cm / 5 7/8" | 12-301-16-07<br>16 cm / 6 2/8" |
| 1:2                              | 1:2                            | 1:2                            | 1:2                              | 1:2                            |

1/1

|                                |                                  |                            |                                |                               |
|--------------------------------|----------------------------------|----------------------------|--------------------------------|-------------------------------|
|                                |                                  |                            |                                |                               |
| 12-301-18-07<br>18 cm / 7 1/8" | 12-301-20-07<br>20,5 cm / 8 1/8" | 12-301-23-07<br>23 cm / 9" | 12-301-25-07<br>25 cm / 9 7/8" | 12-301-30-07<br>30,5 cm / 12" |
| 1:2                            | 1:2                              | 1:2                        | 1:2                            | 1:2                           |

12-301-10-07 -  
12-301-30-07

Standardmodell  
 standard pattern  
 modelo estándar  
 modèle standard  
 modello standard



1/1

|                                |                                |                                  |                                |
|--------------------------------|--------------------------------|----------------------------------|--------------------------------|
|                                |                                |                                  |                                |
| 12-302-11-07<br>12 cm / 4 5/8" | 12-302-13-07<br>13 cm / 5 1/8" | 12-302-14-07<br>14,5 cm / 5 7/8" | 12-302-16-07<br>16 cm / 6 2/8" |
| 2:3                            | 2:3                            | 2:3                              | 2:3                            |

1/1

|                                |                                  |                                |
|--------------------------------|----------------------------------|--------------------------------|
|                                |                                  |                                |
| 12-302-18-07<br>18 cm / 7 1/8" | 12-302-20-07<br>20,5 cm / 8 1/8" | 12-302-25-07<br>25 cm / 9 7/8" |
| 2:3                            | 2:3                              | 2:3                            |

12-302-11-07 -  
12-302-25-07

12

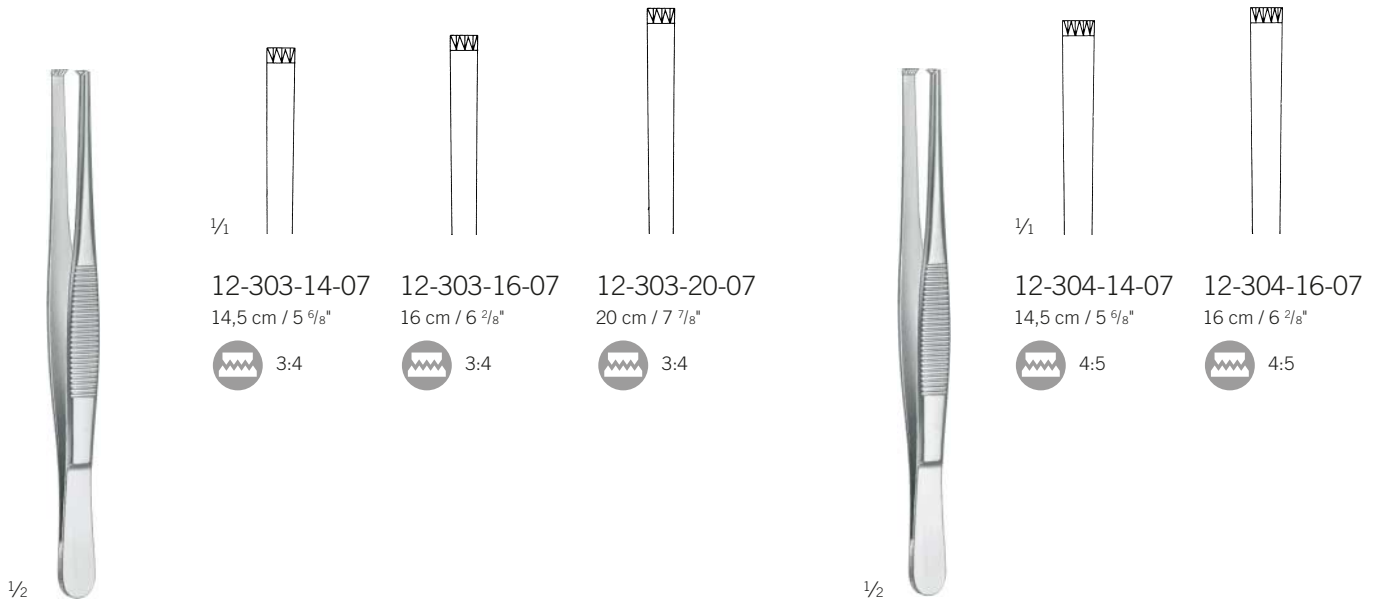
## Chirurgische Pinzetten

Tissue Forceps

Pinzas de disección con diente

Pinces à dissection à griffes

Pinze per dissezione con denti



12-303-14-07  
14,5 cm / 5 9/16"



3:4

12-303-16-07  
16 cm / 6 2/8"



3:4

12-303-20-07  
20 cm / 7 7/8"



3:4

12-304-14-07  
14,5 cm / 5 9/16"



4:5

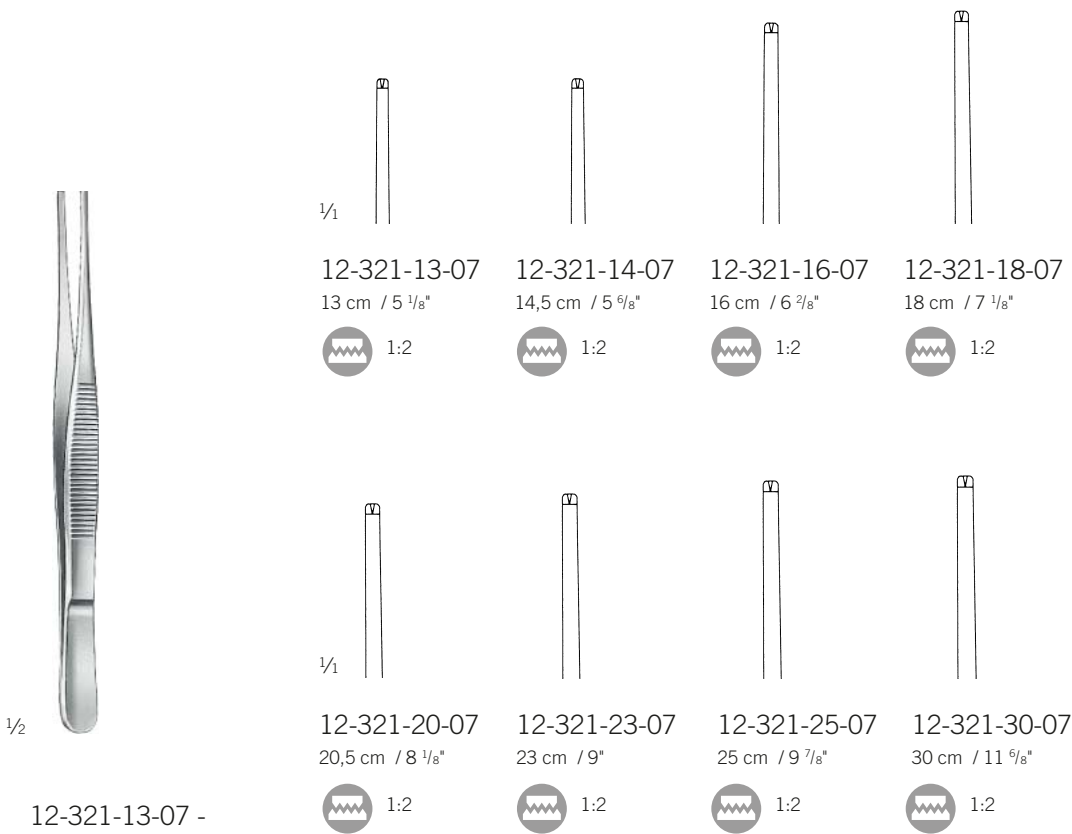
12-304-16-07  
16 cm / 6 2/8"



4:5

12-303-14-07 -  
12-303-20-07

12-304-14-07 -  
12-304-16-07



12-321-13-07  
13 cm / 5 1/8"



1:2

12-321-14-07  
14,5 cm / 5 9/16"



1:2

12-321-16-07  
16 cm / 6 2/8"



1:2

12-321-18-07  
18 cm / 7 1/8"



1:2

12-321-20-07  
20,5 cm / 8 1/8"



1:2

12-321-23-07  
23 cm / 9"



1:2

12-321-25-07  
25 cm / 9 7/8"



1:2

12-321-30-07  
30 cm / 11 6/8"



1:2

12-321-13-07 -  
12-321-30-07

mittelbreit  
medium  
medio  
moyen  
medio

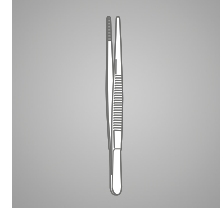


# Chirurgische Pinzetten

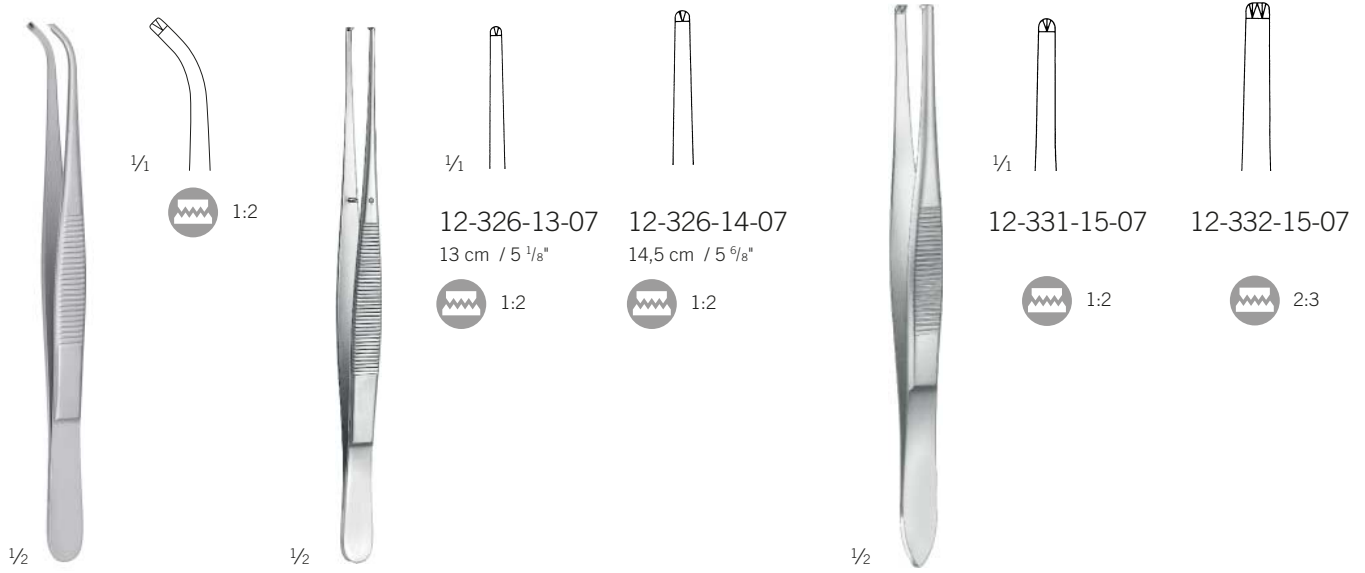
Tissue Forceps  
 Pinzas de disección con diente  
 Pincers à dissection à griffes  
 Pinze per dissezione con denti

# Pinzetten

Forceps  
 Pinzas  
 Pincers  
 Pinze



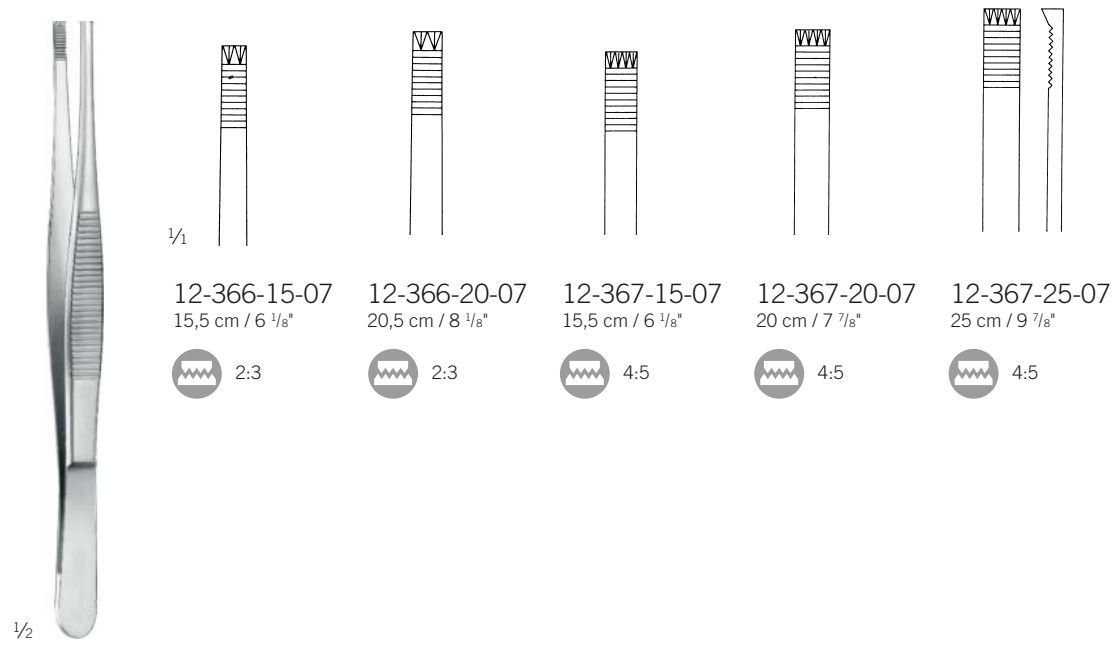
12



12-323-15-07  
 14,5 cm / 5 7/8"

12-326-13-07 -  
 12-326-14-07

Stille  
 12-331-15-07 -  
 12-332-15-07  
 15 cm / 5 7/8"



Adlerkreutz  
 12-366-15-07 -  
 12-367-25-07

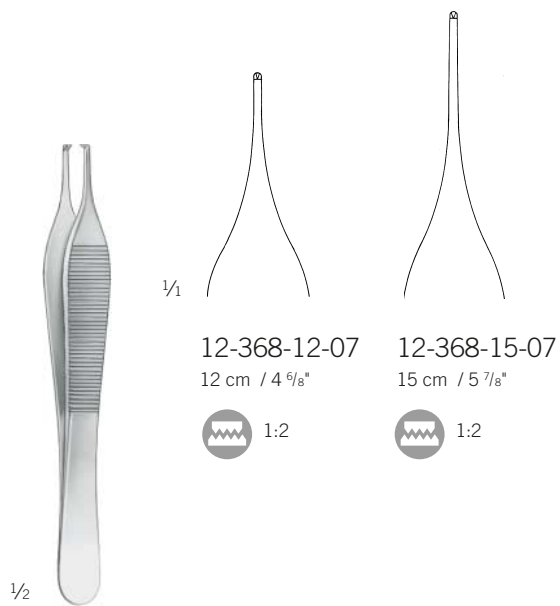
# Chirurgische Pinzetten

Tissue Forceps

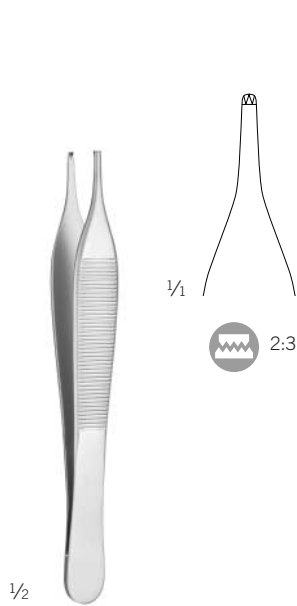
Pinzas de disección con diente

Pinces à dissection à griffes

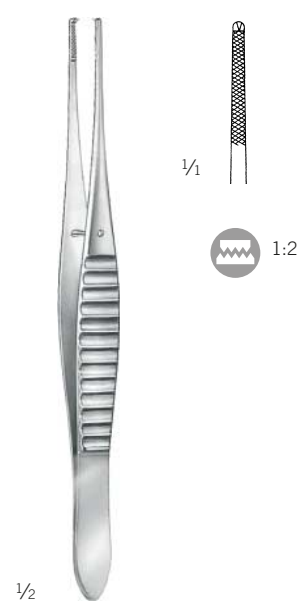
Pinze per dissezione con denti



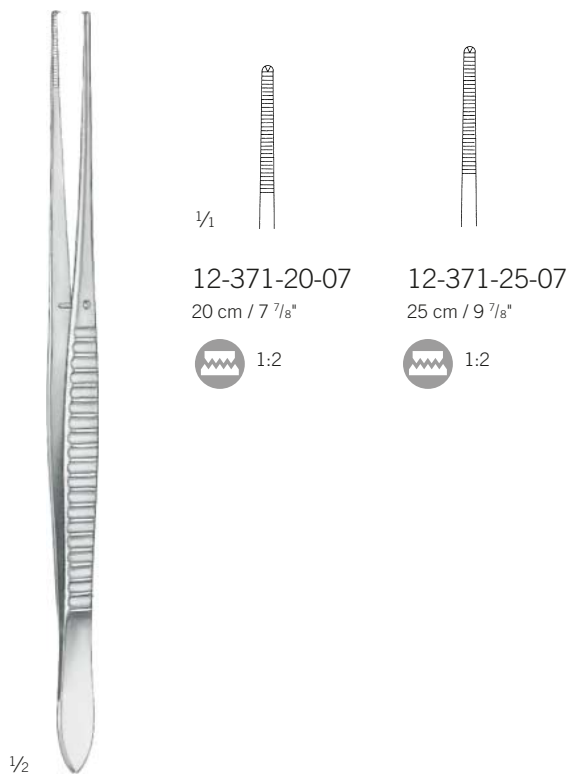
Adson  
12-368-12-07 -  
12-368-15-07



Adson  
12-369-12-07  
12 cm / 4 9/16"



Gillies  
12-370-15-07  
15,5 cm / 6 1/8"



Waugh  
12-371-20-07 -  
12-371-25-07



Semken  
12-372-12-07 -  
12-372-15-07

## Chirurgische Pinzetten, Mikropinzetten

Tissue Forceps, Micro Forceps

Pinzas de disección con diente, Micro Pinzas

Pinces à dissection à griffes, Micro-Pinces

Pinze per dissezione con denti, Micro-Pinze

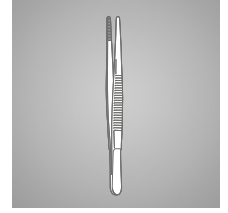
## Pinzetten

Forceps

Pinzas

Pinces

Pinze



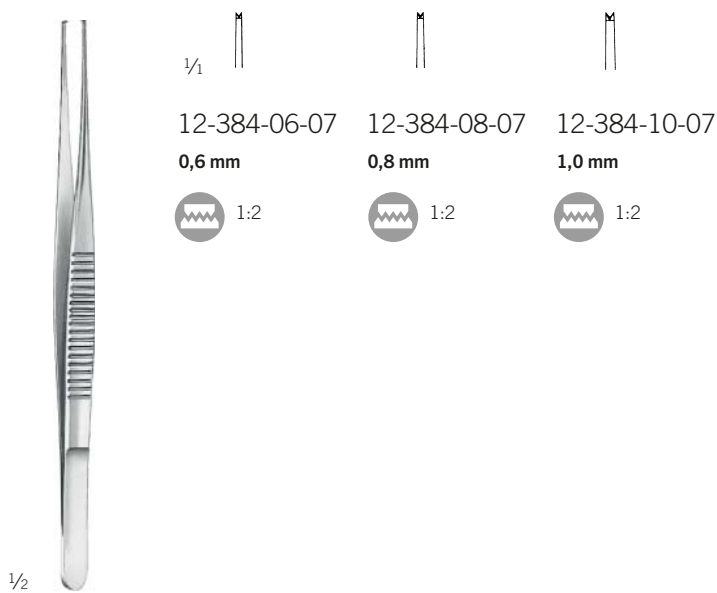
Taylor  
12-374-17-07  
17,5 cm / 6 7/8"



Taylor  
12-380-17-07  
17 cm / 6 5/8"  
mit Schaberende  
with dissector end  
con rascador  
à rugine  
con estremita a forma di raschino



Taylor  
12-383-17-07  
18,5 cm / 7 2/8"  
mit Schaberende  
with dissector end  
con rascador  
à rugine  
con estremita a forma di raschino



12-384-06-07 -  
12-384-10-07  
15,5 cm / 6 1/8"

12

## Chirurgische Pinzetten

Tissue Forceps

Pinzas de disección con diente

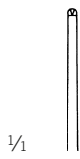
Pinces à dissection à griffes

Pinze per dissezione con denti



1/2

Gerald  
12-386-17-07 -  
12-387-17-07



1/1

12-386-17-07  
17,5 cm / 6 7/8"



1:2



12-387-17-07  
17 cm / 6 5/8"



1:2



1/2

Cushing  
12-388-17-07  
18 cm / 7 1/8"



1/1

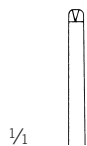


1:2



1/2

Potts-Smith  
12-392-18-07 -  
12-392-25-07



1/1

12-392-18-07  
18 cm / 7 1/8"



1:2



12-392-21-07  
21 cm / 8 2/8"



1:2



12-392-25-07  
25 cm / 9 7/8"

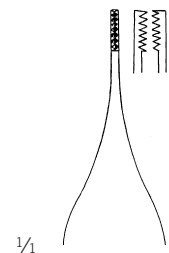


1:2



1/2

Adson-Brown  
12-400-12-07  
12 cm / 4 5/8"



1/1



7:7

## Anatomische Pinzetten, Chirurgische Pinzetten

Dissecting Forceps, Tissue Forceps

Pinzas de disección, Pinzas de disección con dientes

Pinces à dissection, Pinces à dissection à griffes

Pinze per dissezione, Pinze per dissezione con denti

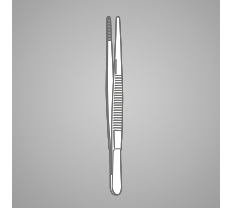
## Pinzetten

Forceps

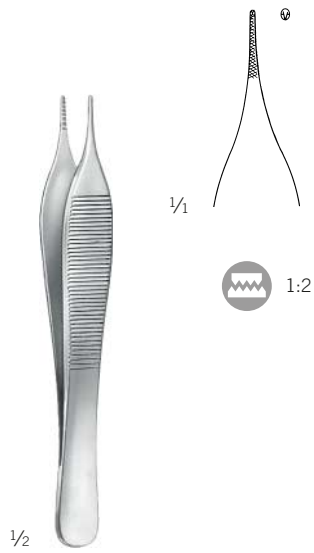
Pinzas

Pinces

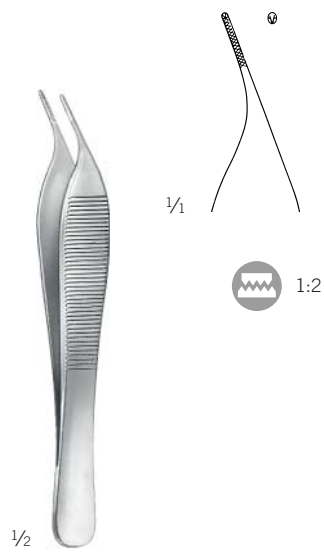
Pinze



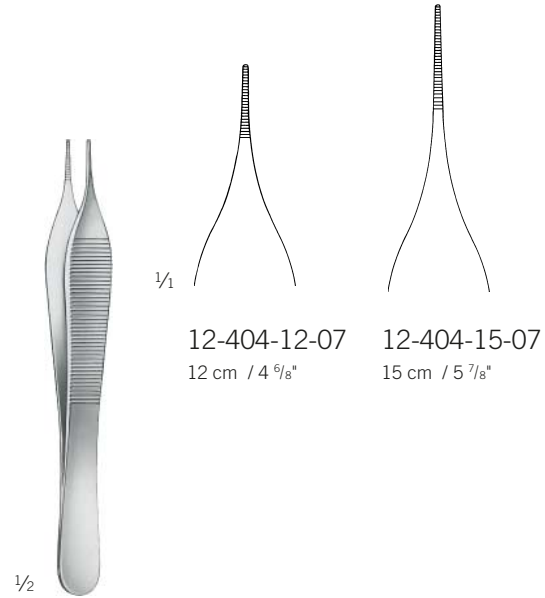
12



Mini-Adson  
12-402-12-07  
12 cm / 4 5/8"



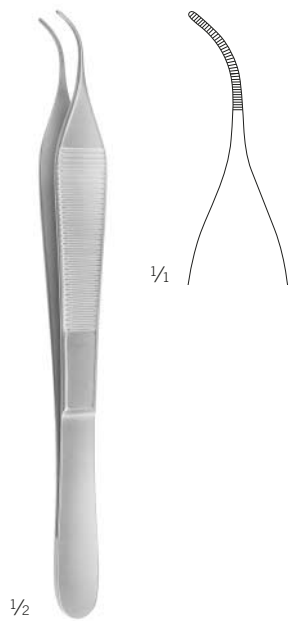
Mini-Adson  
12-403-12-07  
12 cm / 4 5/8"



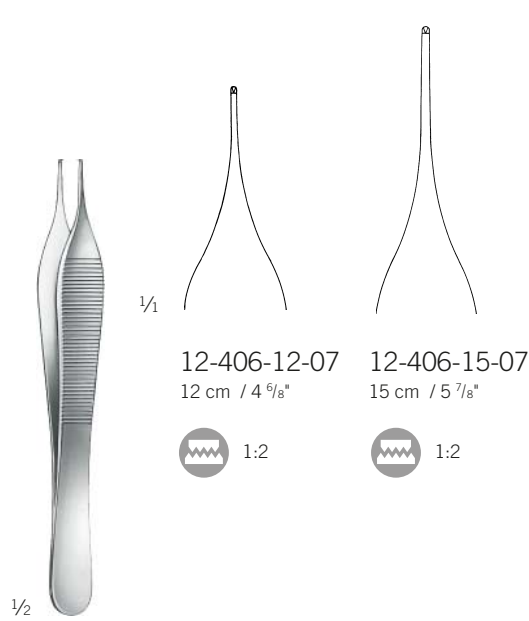
12-404-12-07  
12 cm / 4 5/8"

12-404-15-07  
15 cm / 5 7/8"

Mikro-Adson  
12-404-12-07 -  
12-404-15-07



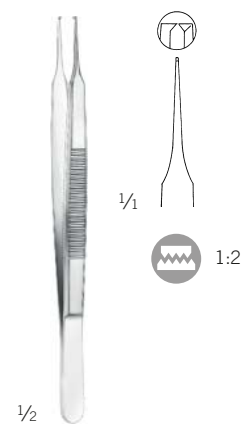
Mikro-Adson  
Shigeno  
12-405-15-07  
15 cm / 5 7/8"



12-406-12-07  
12 cm / 4 5/8"

12-406-15-07  
15 cm / 5 7/8"

Mikro-Adson  
12-406-12-07 -  
12-406-15-07



12-408-11-07  
10,5 cm / 4 1/8"  
sehr feine Zähne  
very fine teeth  
dientes muy finos  
dents très fines  
denti molto fini

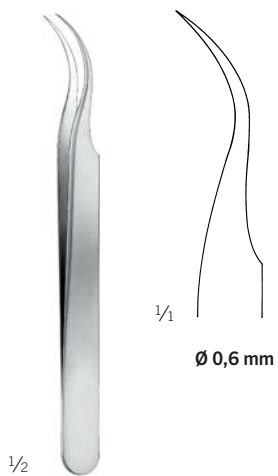
# Uhrmacher-Pinzetten

Jeweler Type Forceps

Pinzas de relojero

Pinces d'horloger

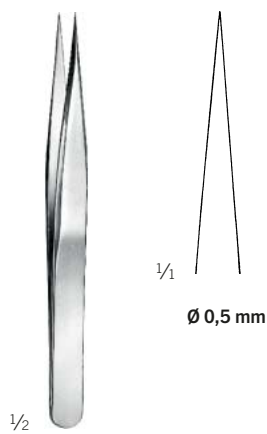
Pinze da orologiaio



12-409-12-07

12 cm / 4 5/8"

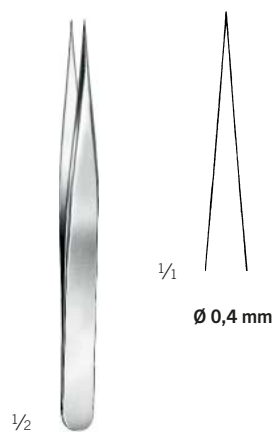
Fig. 7



12-410-12-07

12 cm / 4 5/8"

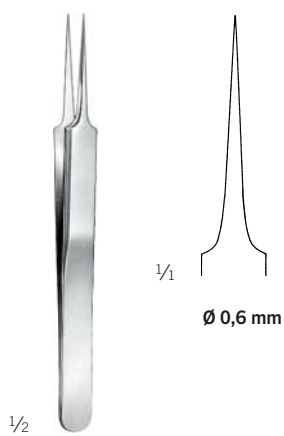
Fig. 3



12-412-11-07

11 cm / 4 3/8"

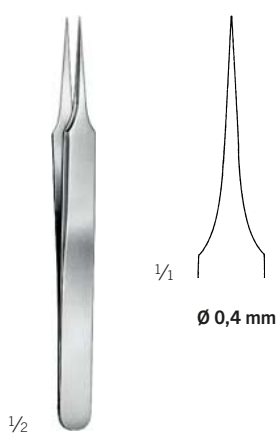
Fig. 3 C



12-414-11-07

11 cm / 4 3/8"

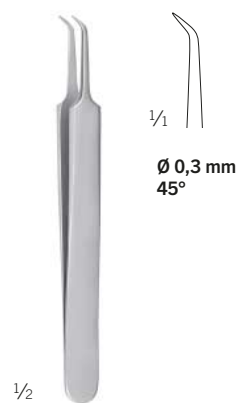
Fig. 5



12-416-11-07

11 cm / 4 3/8"

Fig. 4



12-418-11-07

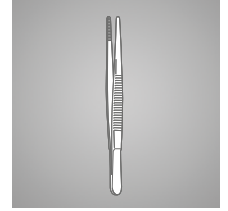
11 cm / 4 3/8"

## Chirurgische Pinzetten

Tissue Forceps  
 Pinzas de disección con diente  
 Pincès à dissection à griffes  
 Pinze per dissezione con denti

## Pinzetten

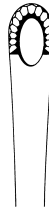
Forceps  
 Pinzas  
 Pincès  
 Pinze



1/1



12-420-15-07  
 15 cm / 5 7/8"



12-420-20-07  
 20 cm / 7 7/8"



12-420-25-07  
 25,5 cm / 10"

1/2

Russ. Modell  
 12-420-15-07 -  
 12-420-25-07

12



1/1



12-426-14-07  
 14,5 cm / 5 6/8"



12-426-16-07  
 16 cm / 6 2/8"



12-426-20-07  
 20,5 cm / 8 1/8"



12-426-25-07  
 25 cm / 9 7/8"

1/2

Durante  
 12-426-14-07 -  
 12-426-25-07



1/1



12-444-18-07  
 18 cm / 7 1/8"



1/2

Stille-Barraya  
 12-444-18-07

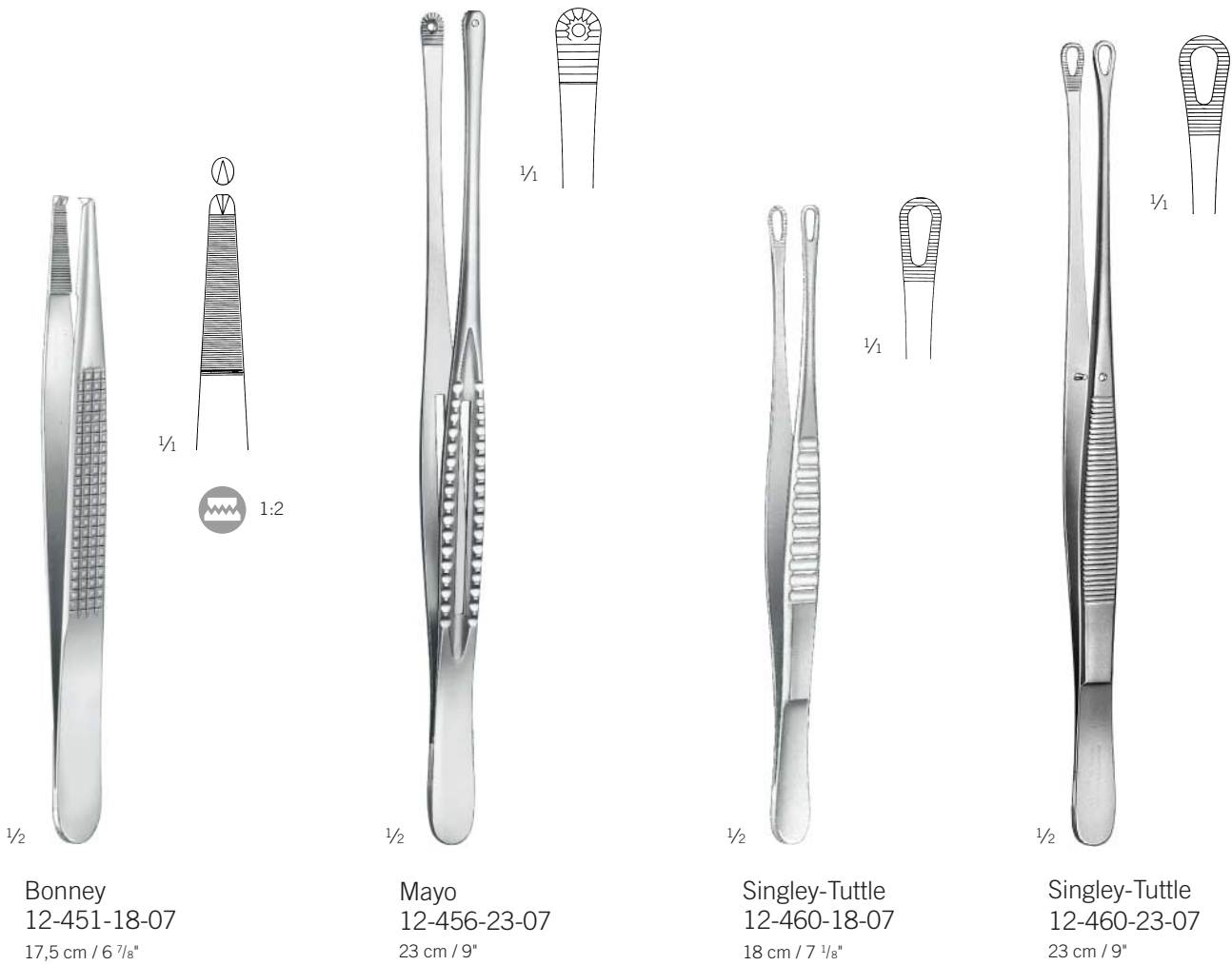
## Chirurgische Pinzetten, Anatomische Pinzetten

Tissue Forceps, Dissecting Forceps

Pinzas de disección con diente, Pinzas de disección

Pinces à dissection à griffes, Pinces à dissection

Pinze per dissezione con denti, Pinze per dissezione





## Chirurgische Pinzetten

Tissue Forceps

Pinzas de disección con diente

Pinces à dissection à griffes

Pinze per dissezione con denti

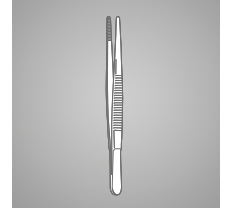
## Pinzetten

Forceps

Pinzas

Pinces

Pinze



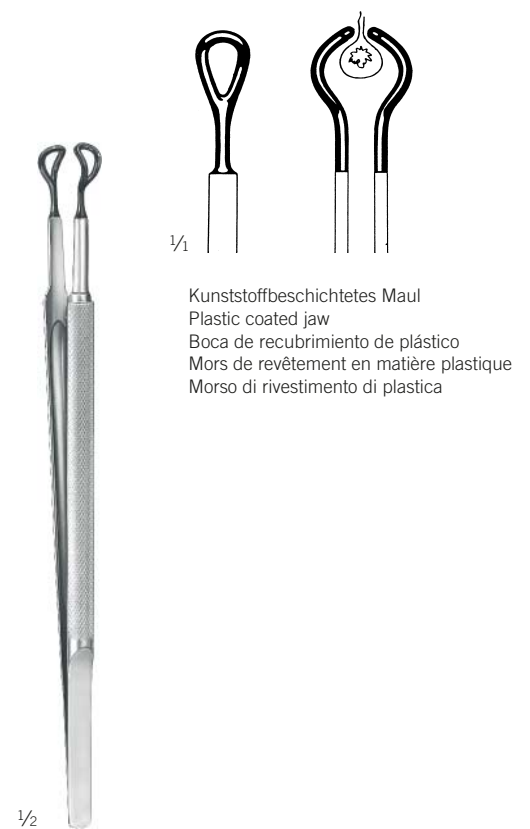
12



Nelson  
12-466-23-07  
23 cm / 9"



Resano  
12-467-23-07  
23 cm / 9"



Hepp-Scheidel  
12-468-18-07  
18 cm / 7 1/8"  
Tubenfasspinzette  
Tubal forceps  
Pinza para tubos  
Pince pour saisir les trompes  
pinza oer afferare tubi

## Anatomische Pinzetten, Chirurgische Pinzetten

Dissecting Forceps, Tissue Forceps

Pinzas de disección, Pinzas de disección con dientes

Pinces à dissection, Pinces à dissection à griffes

Pinze per dissezione, Pinze per dissezione con denti



12-502-10-07  
10 cm / 3 7/8"



12-503-10-07  
10 cm / 3 7/8"



12-505-10-07  
9,5 cm / 3 5/8"



12-512-10-07  
10 cm / 3 7/8"



12-513-10-07  
10 cm / 3 7/8"



12-515-10-07  
9,5 cm / 3 5/8"



1:2



1:2



1:2

1/2

12-502-10-07 -  
12-515-10-07

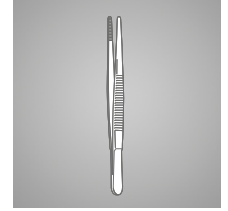
fein  
delicate  
fino  
fin  
fino

## Kurze Mikropinzetten

Short Micro Forceps  
Micro Pinzas, corto  
Micro-Pinces, court  
Micro-Pinze, corto

## Pinzetten

Forceps  
Pinzas  
Pinces  
Pinze



1/2

12-552-01-07 -  
12-553-06-07  
11 cm / 4 3/8"

1/1

|    |              |              |              |
|----|--------------|--------------|--------------|
|    |              |              |              |
| Ø  | 0.15 mm      | 0.20 mm      | 0.30 mm      |
| St | 12-552-01-07 | 12-552-02-07 | 12-552-03-07 |

1/1

|    |              |              |              |
|----|--------------|--------------|--------------|
|    |              |              |              |
| Ø  | 0.50 mm      | 1.2 mm       |              |
| St | 12-553-01-07 | 12-553-05-07 | 12-553-06-07 |

1/1

|   |              |              |              |
|---|--------------|--------------|--------------|
|   | VD           | VD           | VD           |
| Ø   | 0.10 mm      | 0.20 mm      | 0.30 mm      |
| gewinkelt/angled/<br>acodada/angulée/<br>angolata | 10°          | 10°          | 10°          |
| St  | 12-552-04-07 | 12-552-05-07 | 12-552-06-07 |



1/2

12-552-07-07 -  
12-553-09-07  
11 cm / 4 3/8"

1/1

|    |              |              |              |
|----|--------------|--------------|--------------|
|    |              |              |              |
| Ø  | 0.15 mm      | 0.20 mm      | 0.30 mm      |
| St | 12-552-07-07 | 12-552-08-07 | 12-552-09-07 |

1/1

|    |              |              |              |
|----|--------------|--------------|--------------|
|    |              |              |              |
| Ø  | 0.50 mm      | 1.2 mm       |              |
| St | 12-553-07-07 | 12-553-08-07 | 12-553-09-07 |

1/1

|   |              |              |              |
|---|--------------|--------------|--------------|
|   | VD           | VD           | VD           |
| Ø   | 0.10 mm      | 0.20 mm      | 0.30 mm      |
| gewinkelt/angled/<br>acodada/angulée/<br>angolata | 10°          | 10°          | 10°          |
| St  | 12-552-10-07 | 12-552-11-07 | 12-552-12-07 |

12

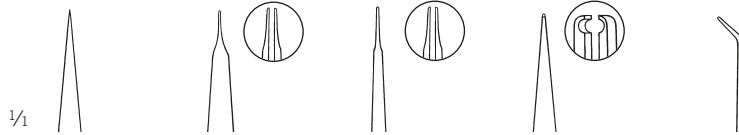
## Mikropinzetten, Gefäß-Dilatationspinzetten

Micro Forceps, Micro dilating forceps

Micro Pinzas, Micro pinza de dilatación

Micro-Pinces, Micro pince à dilater

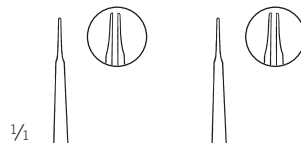
Micro-Pinze, Micro pinze per dilatazione



|                  |    | VD           | VD           | Pierse       | 45°          |
|------------------|----|--------------|--------------|--------------|--------------|
| 11 cm / 4 3/8"   | Ø  | 0.30 mm      | 0.20 mm      | 0.30 mm      | 0.30 mm      |
|                  | St | 12-560-00-07 |              |              | 12-560-05-07 |
| 13,5 cm / 5 3/8" | St | 12-561-00-07 | 12-561-02-07 | 12-561-03-07 | 12-561-05-07 |

1/2

Jeweler mod.  
12-560-00-07 -  
12-561-45-07



|                |   | VD           | VD           |
|----------------|---|--------------|--------------|
| 11 cm / 4 3/8" | Ø   | 0.20 mm      | 0.30 mm      |
|                | gewinkelt/angled/<br>acodada/angulée/<br>angolata | 10°          | 10°          |
|                | St  | 12-560-02-07 | 12-560-03-07 |

1/2

Jeweler mod.  
12-560-02-07 -  
12-560-03-07



|                |    |              |              | 45°          |                  |              | Pierse       |
|----------------|----|--------------|--------------|--------------|------------------|--------------|--------------|
| 15 cm / 5 7/8" | Ø  | 0.30 mm      | 0.30 mm      | 0.30 mm      | R Ø 1.0 x 0.5 mm | VD 0.30 mm   | P 0.30 m     |
|                | St | 12-562-00-07 | 12-562-01-07 | 12-562-02-07 | 12-562-03-07     | 12-562-04-07 | 12-562-05-07 |
| 18 cm / 7 1/8" | St | 12-563-00-07 | 12-563-01-07 | 12-563-02-07 | 12-563-03-07     | 12-563-04-07 | 12-563-05-07 |

1/2

12-562-00-07 -  
12-563-05-07

# Mikropinzetten

Micro Forceps

Micro Pinzas

Micro-Pinces

Micro-Pinze



1/2



1/1



|                |    | 1:2          | 1:2          | 1:2          | 1:2          |
|----------------|----|--------------|--------------|--------------|--------------|
| 15 cm / 5 7/8" | Ø  | 0.40 mm      | 0.40 mm      | 0.70 mm      | 0.70 mm      |
|                | St | 12-568-15-07 | 12-569-15-07 | 12-570-15-07 | 12-571-15-07 |
|                | Ti | 12-582-15-09 | 12-583-15-09 |              |              |
|                |    |              |              |              |              |
| 18 cm / 7 1/8" | St | 12-568-18-07 | 12-569-18-07 | 12-570-18-07 | 12-571-18-07 |
|                | Ti | 12-582-18-09 | 12-583-18-09 |              |              |

12-568-15-07 -  
12-583-18-09



1/2



1/1



|                |    |              |              |              | Atrauma      |              |
|----------------|----|--------------|--------------|--------------|--------------|--------------|
| 15 cm / 5 7/8" | Ø  | 1.0 x 0.5 mm | 1.0 x 0.5 mm | 2.0 x 1.0 mm | 2.0 x 1.0 mm | 1.2 mm       |
|                | St | 12-574-15-07 | 12-774-15-07 | 12-576-15-07 | 12-776-15-07 | 12-589-15-07 |
|                | Ti | 12-586-15-09 | 12-786-15-09 | 12-588-15-09 | 12-787-15-09 | 12-590-15-09 |
| 18 cm / 7 1/8" | St | 12-574-18-07 | 12-774-18-07 | 12-576-18-07 | 12-776-18-07 | 12-589-18-07 |
|                | Ti | 12-586-18-09 | 12-786-18-09 | 12-588-18-09 | 12-787-18-09 | 12-590-18-09 |
| 21 cm / 8 3/8" | St | 12-574-21-07 | 12-774-21-07 | 12-576-21-07 | 12-776-21-07 | 12-589-21-07 |
|                | Ti | 12-586-21-09 | 12-786-21-09 | 12-588-21-09 | 12-787-21-09 | 12-590-21-09 |

12-574-15-07 -  
12-590-21-09

## Mikropinzetten, Gefäß-Dilatationspinzetten

Micro Forceps, Micro dilating forceps

Micro Pinzas, Micro pinza de dilatación

Micro-Pinces, Micro pince à dilater

Micro-Pinze, Micro pinze per dilatazione



1/2

12-564-15-07 -  
12-581-21-09



diamond-coated

1/1



|                | Ø  | 0.40 mm      | 0.40 mm      | 0.70 mm      | 0.70 mm      | 0.80 mm      | 0.80 mm      |
|----------------|----|--------------|--------------|--------------|--------------|--------------|--------------|
| 15 cm / 5 7/8" | St | 12-564-15-07 | 12-565-15-07 | 12-566-15-07 | 12-567-15-07 |              |              |
|                | Ti | 12-578-15-09 | 12-579-15-09 |              |              | 12-580-15-09 | 12-581-15-09 |
| 18 cm / 7 1/8" | St | 12-564-18-07 | 12-565-18-07 | 12-566-18-07 | 12-567-18-07 |              |              |
|                | Ti | 12-578-18-09 | 12-579-18-09 |              |              | 12-580-18-09 | 12-581-18-09 |
| 21 cm / 8 2/8" | St |              |              | 12-566-21-07 | 12-567-21-07 |              |              |
|                | Ti |              |              |              |              | 12-580-21-09 | 12-581-21-09 |



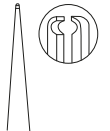
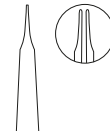
1/2

12-591-01-07 -  
12-592-05-07



diamond-coated

1/1



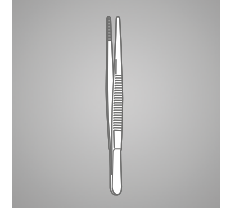
|                |    |              |              | 45°          |              | VD           | Pierse       |
|----------------|----|--------------|--------------|--------------|--------------|--------------|--------------|
|                | Ø  | 0.30 mm      | 0.30 mm      | 0.30 mm      | 1.0 x 0.5 mm | 0.30 mm      | 0.40 mm      |
| 15 cm / 5 7/8" | St | 12-591-00-07 | 12-591-01-07 | 12-591-02-07 | 12-591-03-07 | 12-591-04-07 | 12-591-05-07 |
| 18 cm / 7 1/8" | St | 12-592-00-07 | 12-592-01-07 | 12-592-02-07 | 12-592-03-07 | 12-592-04-07 | 12-592-05-07 |

## Splitterpinzetten

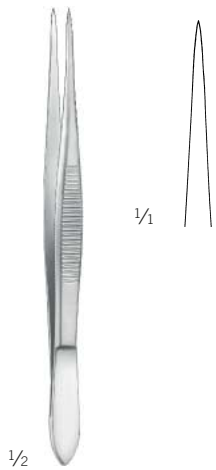
Splinter Forceps  
Pinzas para espinas  
Pincas à échardes  
Pinze per scheggie

## Pinzetten

Forceps  
Pinzas  
Pincas  
Pinze

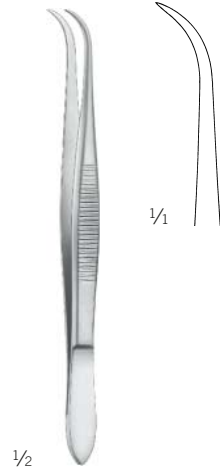


12



12-600-12-07

12,5 cm / 4 7/8"  
glattes Maul  
smooth jaw  
boca lisa  
mors lisse  
morso liscio



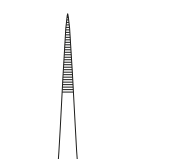
12-601-12-07

12,5 cm / 4 7/8"  
glattes Maul  
smooth jaw  
boca lisa  
mors lisse  
morso liscio



1/1

12-604-09-07  
9 cm / 3 4/8"



12-604-11-07  
10,5 cm / 4 1/8"

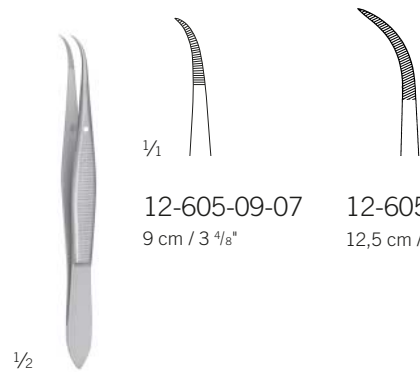


12-604-12-07  
12,5 cm / 4 7/8"

1/2

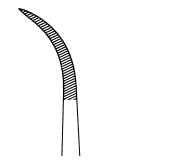
12-604-09-07 -  
12-604-12-07

gerieftes Maul  
serrated jaw  
boca estriada  
mors strié  
morso striato



1/1

12-605-09-07  
9 cm / 3 4/8"



12-605-12-07  
12,5 cm / 4 7/8"

1/2

12-605-09-07 -  
12-605-12-07

gerieftes Maul  
serrated jaw  
boca estriada  
mors strié  
morso striato

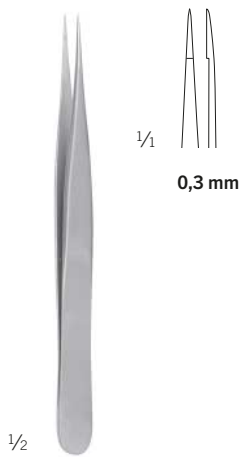
## Splitterpinzetten

Splinter Forceps

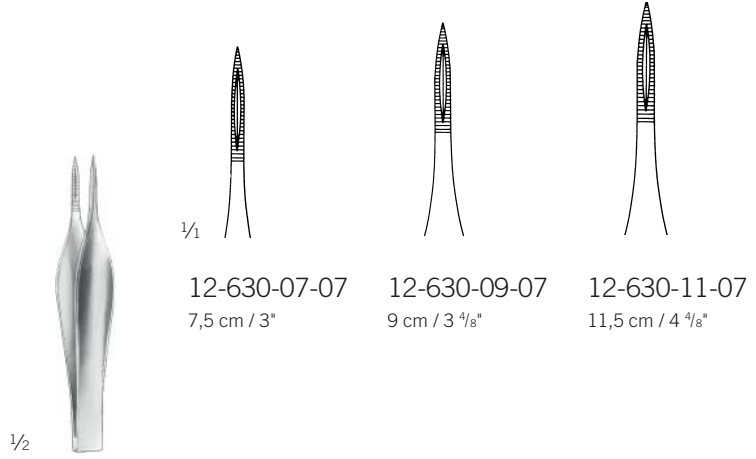
Pinzas para espinas

Pinces à échardes

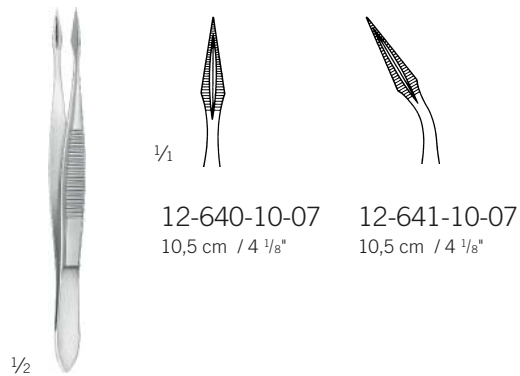
Pinze per scheggie



12-624-12-07  
12 cm / 5 <sup>9</sup>/<sub>8</sub>"



Feilchenfeld  
12-630-07-07 -  
12-630-11-07



Hunter  
12-640-10-07 -  
12-641-10-07

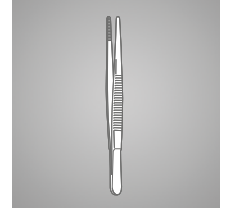


## Cilienpinzetten

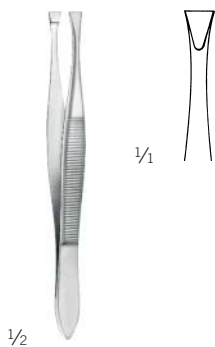
Cilia Forceps  
Pinzas depilatorias  
Pincès à épiler les cils  
Pinze depilatoria

## Pinzetten

Forceps  
Pinzas  
Pincès  
Pinze



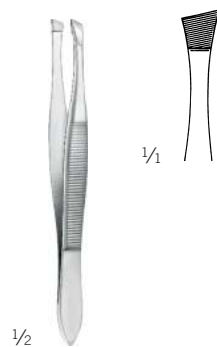
12



Littauer  
12-664-08-07

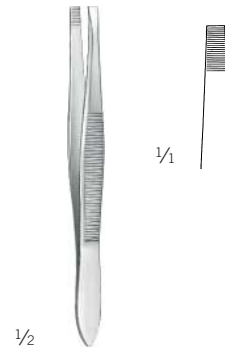
8,5 cm / 3 <sup>3</sup>/<sub>8</sub>"

glattes Maul  
smooth jaw  
boca lisa  
mors lisse  
morso liscio



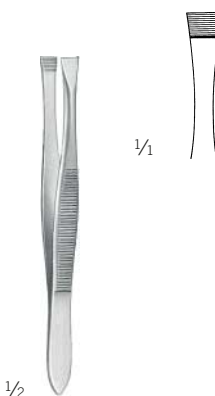
12-666-09-07

9 cm / 3 <sup>4</sup>/<sub>8</sub>"



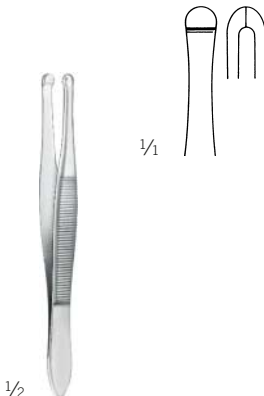
Douglas  
12-674-09-07

9 cm / 3 <sup>4</sup>/<sub>8</sub>"



Douglas  
12-676-09-07

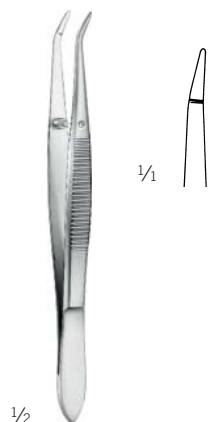
9 cm / 3 <sup>4</sup>/<sub>8</sub>"



Beer  
12-680-09-07

9 cm / 3 <sup>4</sup>/<sub>8</sub>"

glattes Maul  
smooth jaw  
boca lisa  
mors lisse  
morso liscio



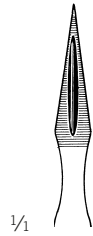
Barraquer  
12-695-10-07

11 cm / 4 <sup>3</sup>/<sub>8</sub>"

glattes Maul  
smooth jaw  
boca lisa  
mors lisse  
morso liscio

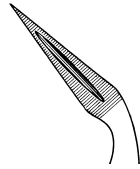
## Splitterzangen

Splinter Forceps  
Pinzas para espinas  
Pincers à échardes  
Pinze per scheggie



1/1

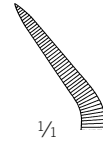
12-720-13-07  
14 cm / 5 4/8"



12-721-13-07  
13,5 cm / 5 3/8"

1/2

Stieglitz  
12-720-13-07 -  
12-721-13-07



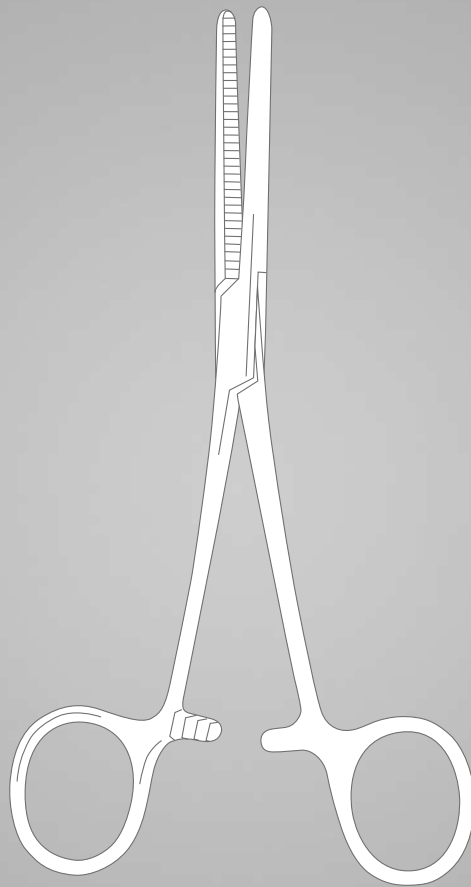
1/1

1/2

Peet  
12-725-11-07  
12,5 cm / 4 7/8"

Arterienklemmen  
Haemostatic Forceps  
Pinzas hemostáticas  
Pincès hémostatiques  
Pinze emostatiche

# 13



## Clip-Anlegepinzette, Gefäßclips

Clip Applying Forceps, Vessel Clips

Pinzas para aplicar clips,

Pinces pour poser les clips vasculaires, Clips vasculaires

Pinze per applicazione clips vascolari,



Biemer  
13-010-00-07  
16 cm / 6 2/8"  
Gefäßspreizer  
Vascular spreader  
Dilatador de vasos  
Ecarteur vasculaire  
Dilatatore vascolare



➔ 13-052-04-07 -  
13-060-04-07

13-050-14-07  
14,5 cm / 5 5/8"  
ohne Sperre  
w/o ratchet  
sin cremallera  
sans cremaillère  
senza cremagliera



➔ 13-052-04-07 -  
13-060-04-07

13-051-14-07  
14,5 cm / 5 5/8"  
mit Sperre  
with ratchet  
con cremallera  
avec cremaillère  
con cremagliera



Biemer  
13-052-04-07 -  
13-053-05-07



|    |              |              |              |
|----|--------------|--------------|--------------|
| St | 13-052-04-07 | 13-052-05-07 | 13-053-05-07 |
|    | 14 mm        | 17 mm        | 17 mm        |
|    | 6 mm         | 9 mm         | 9 mm         |
|    | 4 mm         | 7 mm         | 7 mm         |
| P  | 30 - 40 g    | 30 - 40 g    | 20 - 25 g    |

## Gefäßclips, Approximatoren

Vessel Clips, Approximators  
Clips vasculares, Aproximadores  
Clips vasculaires, Approximateurs  
Clip vascolari, Approssimatori

## Arterienklemmen

Haemostatic Forceps  
Pinzas hemostáticas  
Pincas hémostatiques  
Pinze emostatiche



Biemer-Müller  
13-054-05-07 -  
13-059-05-07



|           | gerade, breit<br>straight, wide<br>recto, ancho<br>droit, large<br>retto, largo | gewinkelt, breit<br>angled, wide<br>angulado, ancho<br>coudé, large<br>angulato, largo | gerade, schmal<br>straight, narrow<br>recto, estrecho<br>droit, étroit<br>retto, stretto | gerade, schmal<br>straight, narrow<br>recto, estrecho<br>droit, étroit<br>retto, stretto | gewinkelt, schmal<br>angled, narrow<br>angulado, estrecho<br>coudé, étroit<br>angulato, stretto |
|-----------|---|--|--|--|---|
| <b>St</b> | 13-054-05-07  | 13-055-05-07   | 13-056-03-07   | 13-058-05-07   | 13-059-05-07  |
|           | 17 mm   | 17 mm  | 13 mm  | 17 mm  | 17 mm   |
|           | 9 mm  | 9 mm   | 4,5 mm   | 9 mm   | 9 mm  |
|           | 7 mm  | 7 mm   | 4 mm   | 7 mm   | 7 mm  |
| <b>P</b>  | 30 - 40 g   | 30 - 40 g  | 30 - 40 g  | 30 - 40 g  | 25 - 30 g   |

## Approximatoren

Approximators

Aproximadores

Approximateurs

Approssimatori

für Mikro-Gefäßanastomosen in der Tiefe  
for Micro vessel anastomosis in the depth  
para micro anastomosis en la profundidad  
pour micro-anastomoses vasculaires en profondeur  
per micro-anastomosi vascolari nella profondità



13-062-00-07  
komplett mit Schlüssel  
complete with key  
completo con llave  
complet avec clef  
completti con chiave



13-062-01-07  
Schlüssel für Approximator  
Key for Approximator  
Llave para aproximador  
Clef pour approximateur  
Chiave per approssimatore



13-062-02-07



13-062-02-07  
Approximator, allein  
Approximator, only  
Aproximador, suelto  
Approximateur, seul  
Approssimatore, solo

## Mini-Gefäßclips, Clip-Anlegezangen, Bulldogklemmen

Mini Vessel Clips, Clip Applying Forceps

Mini Clips vasculaires, Pinzas para aplicar clips

Micro-clips vasculaires, Pincers pour poser micro-clips

Mini-clip vascolari, Pinze per applicare clips vascolari

## Arterienklemmen

Haemostatic Forceps

Pinzas hemostáticas

Pincers hémostatiques

Pinze emostatiche



1/2



13-102-04-07 -  
13-102-10-07

13-104-14-07

14,5 cm / 5 7/8"

mit Sperre  
with ratchet  
con cremallera  
avec cremaillère  
con cremagliera



1/2



13-102-04-07 -  
13-102-10-07

13-106-18-07

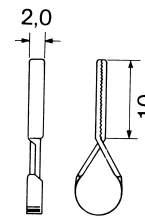
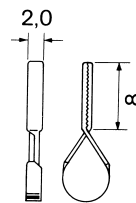
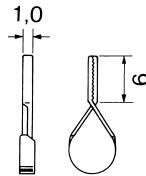
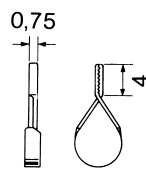
18,5 cm / 7 3/8"

mit Sperre  
with ratchet  
con cremallera  
avec cremaillère  
con cremagliera

1/4



1/4



13-102-04-07 -  
13-102-10-07

| St | 13-102-04-07 | 13-102-06-07 | 13-102-08-07 | 13-102-10-07 |
|----|--------------|--------------|--------------|--------------|
|    | 1,3 cm       | 1,5 cm       | 1,7 cm       | 2,0 cm       |
|    | 4 mm         | 6 mm         | 8 mm         | 10 mm        |
|    | 4 mm         | 5 mm         | 6 mm         | 7 mm         |
|    | 60 g         | 85 g         | 100 g        | 125 g        |

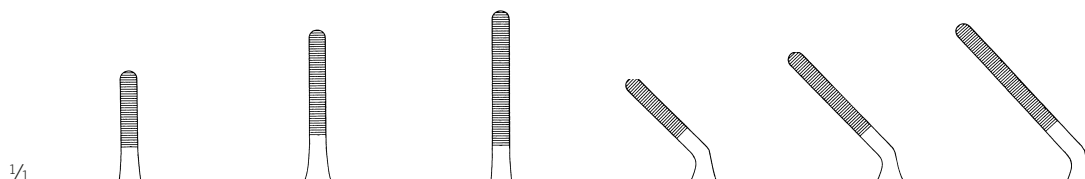
## Bulldogklemmen

Bulldog Clamps  
Clamps Bulldog  
Clamps Bulldog  
Pinze Bulldog



1/2

13-108-10-07 -  
13-109-18-07



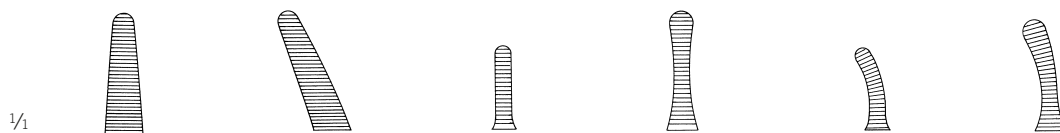
1/4

| St | 13-108-10-07 | 13-108-14-07 | 13-108-18-07 | 13-109-10-07 | 13-109-14-07 | 13-109-18-07 |
|----|--------------|--------------|--------------|--------------|--------------|--------------|
|    | 3,1 cm       | 3,5 cm       | 3,9 cm       | 3,0 cm       | 3,3 cm       | 3,6 cm       |
|    | 10 mm        | 14 mm        | 18 mm        | 10 mm        | 14 mm        | 18 mm        |
|    | 30 g         | 30 g         | 30 g         | 30 g         | 30 g         | 30 g         |



1/2

Dieffenbach  
13-110-06-07 -  
13-115-05-07



1/4

| St | 13-110-06-07  | 13-111-06-07  | 13-114-03-07    | 13-114-05-07 | 13-115-03-07    | 13-115-05-07 |
|----|---------------|---------------|-----------------|--------------|-----------------|--------------|
|    | 6 cm / 2 3/8" | 6 cm / 2 3/8" | 3,5 cm / 1 3/8" | 5 cm / 2"    | 3,5 cm / 1 3/8" | 5 cm / 2"    |
|    | 17 mm         | 17 mm         | 11 mm           | 15 mm        | 11 mm           | 15 mm        |



## Bulldogklemmen

Bulldog Clamps  
Clamps Bulldog  
Clamps Bulldog  
Pinze Bulldog

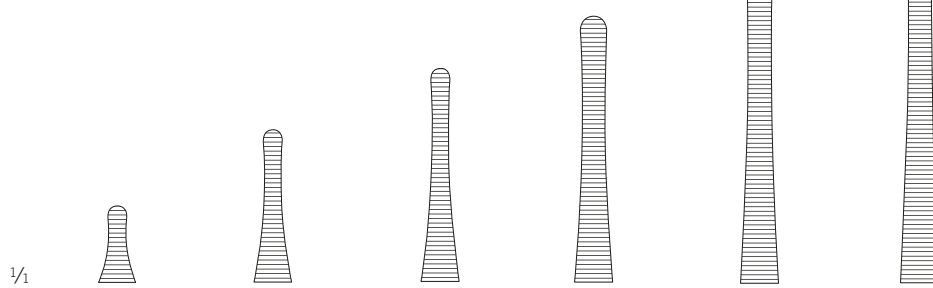
## Arterienklemmen

Haemostatic Forceps  
Pinzas hemostáticas  
Pinces hémostatiques  
Pinze emostatiche



1/2

Johns-Hopkins  
13-115-38-07 -  
13-115-90-07



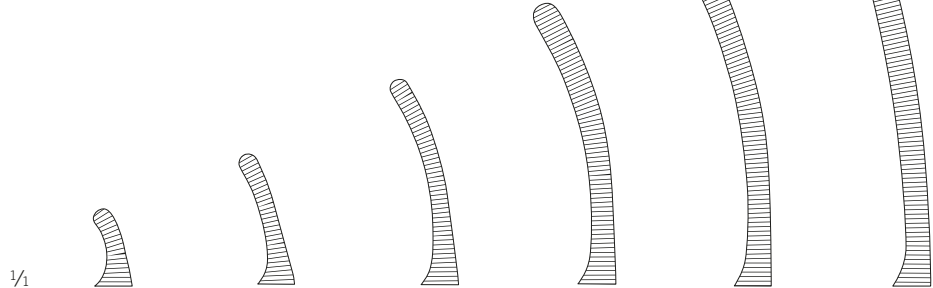
1/1

|           |                 |                 |                 |                 |              |               |
|-----------|-----------------|-----------------|-----------------|-----------------|--------------|---------------|
| <b>St</b> | 13-115-38-07    | 13-115-45-07    | 13-115-55-07    | 13-115-65-07    | 13-115-75-07 | 13-115-90-07  |
|           | 3,8 cm / 1 3/8" | 4,5 cm / 1 6/8" | 5,5 cm / 2 1/8" | 6,5 cm / 2 4/8" | 7,5 cm / 3"  | 9 cm / 3 4/8" |
|           | 12 mm           | 17 mm           | 25 mm           | 30 mm           | 40 mm        | 50 mm         |
| <b>P</b>  | 300 g           | 300 g           | 300 g           | 300 g           | 300 g        | 300 g         |



1/2

Johns-Hopkins  
13-116-38-07 -  
13-116-90-07



1/1

|           |                 |                 |                 |                 |              |               |
|-----------|-----------------|-----------------|-----------------|-----------------|--------------|---------------|
| <b>St</b> | 13-116-38-07    | 13-116-45-07    | 13-116-55-07    | 13-116-65-07    | 13-116-75-07 | 13-116-90-07  |
|           | 3,8 cm / 1 4/8" | 4,5 cm / 1 6/8" | 5,5 cm / 2 1/8" | 6,5 cm / 2 4/8" | 7,5 cm / 3"  | 9 cm / 3 4/8" |
|           | 12 mm           | 17 mm           | 25 mm           | 30 mm           | 40 mm        | 50 mm         |
| <b>P</b>  | 300 g           | 300 g           | 300 g           | 300 g           | 300 g        | 300 g         |

## Bulldogklemmen

Bulldog Clamps

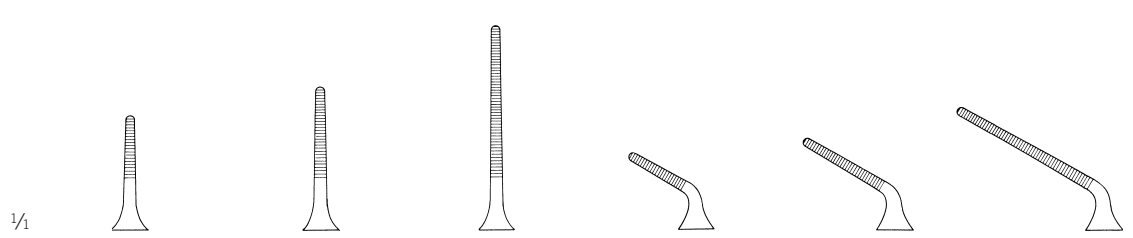
Clamps Bulldog

Clamps Bulldog

Pinze Bulldog

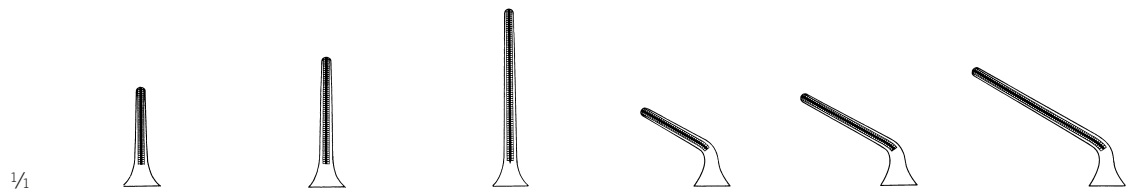


Diethrich  
13-120-08-07 -  
13-121-12-07



|           |                   |                    |                 |                   |                   |                    |
|-----------|-------------------|--------------------|-----------------|-------------------|-------------------|--------------------|
| <b>St</b> | 13-120-08-07      | 13-120-10-07       | 13-120-12-07    | 13-121-08-07      | 13-121-10-07      | 13-121-12-07       |
|           | 4,5 cm / 11 7/16" | 5,0 cm / 12 11/16" | 6,0 cm / 2 3/8" | 4,0 cm / 10 3/16" | 4,5 cm / 11 7/16" | 5,0 cm / 12 11/16" |
|           | 8 mm              | 12 mm              | 20 mm           | 8 mm              | 12 mm             | 20 mm              |
| <b>P</b>  | 50 g              | 50 g               | 50 g            | 50 g              | 50 g              | 50 g               |

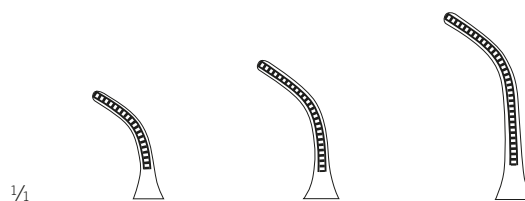
## Atrauma



|           |                   |                    |                   |                   |                   |                    |
|-----------|-------------------|--------------------|-------------------|-------------------|-------------------|--------------------|
| <b>St</b> | 13-122-10-07      | 13-122-14-07       | 13-122-20-07      | 13-123-10-07      | 13-123-14-07      | 13-123-20-07       |
|           | 4,5 cm / 11 7/16" | 5,0 cm / 12 11/16" | 6,0 cm / 15 4/16" | 3,5 cm / 8 14/16" | 4,5 cm / 11 7/16" | 5,0 cm / 12 11/16" |
|           | 10 mm             | 14 mm              | 20 mm             | 10 mm             | 14 mm             | 20 mm              |
| <b>P</b>  | 180 g             | 180 g              | 180 g             | 180 g             | 180 g             | 180 g              |



DeBakey-Diethrich  
13-122-10-07 -  
13-125-20-07



|           |                   |                   |                    |
|-----------|-------------------|-------------------|--------------------|
| <b>St</b> | 13-125-10-07      | 13-125-14-07      | 13-125-20-07       |
|           | 3,5 cm / 8 14/16" | 4,5 cm / 11 7/16" | 5,0 cm / 12 11/16" |
|           | 10 mm             | 14 mm             | 20 mm              |
| <b>P</b>  | 180 g             | 180 g             | 180 g              |

## Bulldogklemmen

Bulldog Clamps  
Clamps Bulldog  
Clamps Bulldog  
Pinze Bulldog

## Arterienklemmen

Haemostatic Forceps  
Pinzas hemostáticas  
Pincas hémostatiques  
Pinze emostatiche



### Atrauma

1/1



1/1

Mini-Glover  
13-132-30-09 -  
13-142-50-09

| Vena      |  |  |  |   |
|-----------|--|--|--|---|
| <b>Ti</b> | 13-132-30-09                               | 13-132-35-09                               | 13-132-40-09                               | 13-132-50-09                                |
|           | 3,0 cm / 7 <sup>10</sup> / <sub>16</sub> " | 3,5 cm / 8 <sup>14</sup> / <sub>16</sub> " | 4,0 cm / 10 <sup>3</sup> / <sub>16</sub> " | 5,0 cm / 12 <sup>11</sup> / <sub>16</sub> " |
|           | 9 mm                                       | 13 mm                                      | 14 mm                                      | 23 mm                                       |
| <b>P</b>  | 110 g <sup>+40</sup> / <sub>-0</sub> g     | 110 g <sup>+40</sup> / <sub>-0</sub> g     | 110 g <sup>+40</sup> / <sub>-0</sub> g     | 110 g <sup>+40</sup> / <sub>-0</sub> g      |

| Arteria   |  |  |  |   |
|-----------|--|--|--|---|
| <b>Ti</b> | 13-142-30-09                               | 13-142-35-09                               | 13-142-40-09                               | 13-142-50-09                                |
|           | 3,0 cm / 7 <sup>10</sup> / <sub>16</sub> " | 3,5 cm / 8 <sup>14</sup> / <sub>16</sub> " | 4,0 cm / 10 <sup>3</sup> / <sub>16</sub> " | 5,0 cm / 12 <sup>11</sup> / <sub>16</sub> " |
|           | 9 mm                                       | 13 mm                                      | 14 mm                                      | 23 mm                                       |
| <b>P</b>  | 220 g <sup>+60</sup> / <sub>-0</sub> g     | 220 g <sup>+60</sup> / <sub>-0</sub> g     | 220 g <sup>+60</sup> / <sub>-0</sub> g     | 220 g <sup>+60</sup> / <sub>-0</sub> g      |

### Atrauma

1/1



1/1

Mini-Glover  
13-133-30-09 -  
13-143-50-09

| Vena      |  |  |  |   |
|-----------|--|--|--|---|
| <b>Ti</b> | 13-133-30-09                               | 13-133-35-09                               | 13-133-40-09                               | 13-133-50-09                                |
|           | 3,0 cm / 7 <sup>10</sup> / <sub>16</sub> " | 3,5 cm / 8 <sup>14</sup> / <sub>16</sub> " | 4,0 cm / 10 <sup>3</sup> / <sub>16</sub> " | 5,0 cm / 12 <sup>11</sup> / <sub>16</sub> " |
|           | 9 mm                                       | 13 mm                                      | 14 mm                                      | 23 mm                                       |
| <b>P</b>  | 110 g <sup>+40</sup> / <sub>-0</sub> g     | 110 g <sup>+40</sup> / <sub>-0</sub> g     | 110 g <sup>+40</sup> / <sub>-0</sub> g     | 110 g <sup>+40</sup> / <sub>-0</sub> g      |

| Arteria   |  |  |  |   |
|-----------|--|--|--|---|
| <b>Ti</b> | 13-143-30-09                               | 13-143-35-09                               | 13-143-40-09                               | 13-143-50-09                                |
|           | 3,0 cm / 7 <sup>10</sup> / <sub>16</sub> " | 3,5 cm / 8 <sup>14</sup> / <sub>16</sub> " | 4,0 cm / 10 <sup>3</sup> / <sub>16</sub> " | 5,0 cm / 12 <sup>11</sup> / <sub>16</sub> " |
|           | 9 mm                                       | 13 mm                                      | 14 mm                                      | 23 mm                                       |
| <b>P</b>  | 220 g <sup>+60</sup> / <sub>-0</sub> g     | 220 g <sup>+60</sup> / <sub>-0</sub> g     | 220 g <sup>+60</sup> / <sub>-0</sub> g     | 220 g <sup>+60</sup> / <sub>-0</sub> g      |

## Bulldogklemmen

Bulldog Clamps

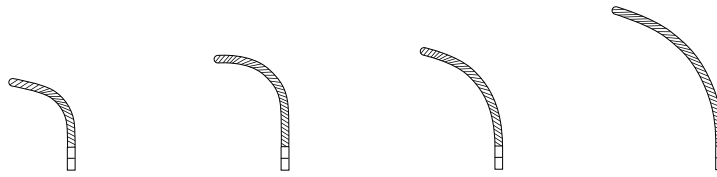
Clamps Bulldog

Clamps Bulldog

Pinze Bulldog

### Atrauma

1/1



| Vena      |  |  |  |   |
|-----------|--|--|--|---|
| <b>Ti</b> | 13-135-30-09                               | 13-135-35-09                               | 13-135-40-09                               | 13-135-50-09                                |
|           | 3,0 cm / 7 <sup>10</sup> / <sub>16</sub> " | 3,5 cm / 8 <sup>14</sup> / <sub>16</sub> " | 4,0 cm / 10 <sup>3</sup> / <sub>16</sub> " | 5,0 cm / 12 <sup>11</sup> / <sub>16</sub> " |
|           | 9 mm                                       | 13 mm                                      | 14 mm                                      | 23 mm                                       |
| <b>P</b>  | 110 g <sup>+40</sup> / <sub>-0</sub> g     | 110 g <sup>+40</sup> / <sub>-0</sub> g     | 110 g <sup>+40</sup> / <sub>-0</sub> g     | 110 g <sup>+40</sup> / <sub>-0</sub> g      |

1/1



Mini-Glover  
13-135-30-09 -  
13-145-50-09

| Arteria   |  |  |  |   |
|-----------|--|--|--|---|
| <b>Ti</b> | 13-145-30-09                               | 13-145-35-09                               | 13-145-40-09                               | 13-145-50-09                                |
|           | 3,0 cm / 7 <sup>10</sup> / <sub>16</sub> " | 3,5 cm / 8 <sup>14</sup> / <sub>16</sub> " | 4,0 cm / 10 <sup>3</sup> / <sub>16</sub> " | 5,0 cm / 12 <sup>11</sup> / <sub>16</sub> " |
|           | 9 mm                                       | 13 mm                                      | 14 mm                                      | 23 mm                                       |
| <b>P</b>  | 220 g <sup>+60</sup> / <sub>-0</sub> g     | 220 g <sup>+60</sup> / <sub>-0</sub> g     | 220 g <sup>+60</sup> / <sub>-0</sub> g     | 220 g <sup>+60</sup> / <sub>-0</sub> g      |



Mini-Glover  
13-131-24-07

24 cm / 9 <sup>4</sup>/<sub>8</sub>"

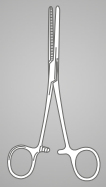
Anlegezange für Bulldogklemmen, Mini-Glover  
Applying Forceps for Bulldog clamps, Mini-Glover  
Pinza aplicadora para clamps bulldog, Mini-Glover  
Pince pour poser les clamps Bulldog, Mini-Glover  
Pinza per posizionare le pinze Bulldog, Mini-Glover

## Arterienklemmen

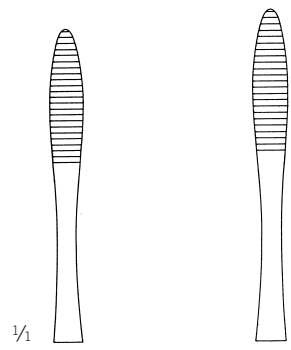
Haemostatic Forceps  
Pinzas hemostáticas  
Pincas hémostatiques  
Pinze emostatiche

## Arterienklemmen

Haemostatic Forceps  
Pinzas hemostáticas  
Pincas hémostatiques  
Pinze emostatiche



1/2

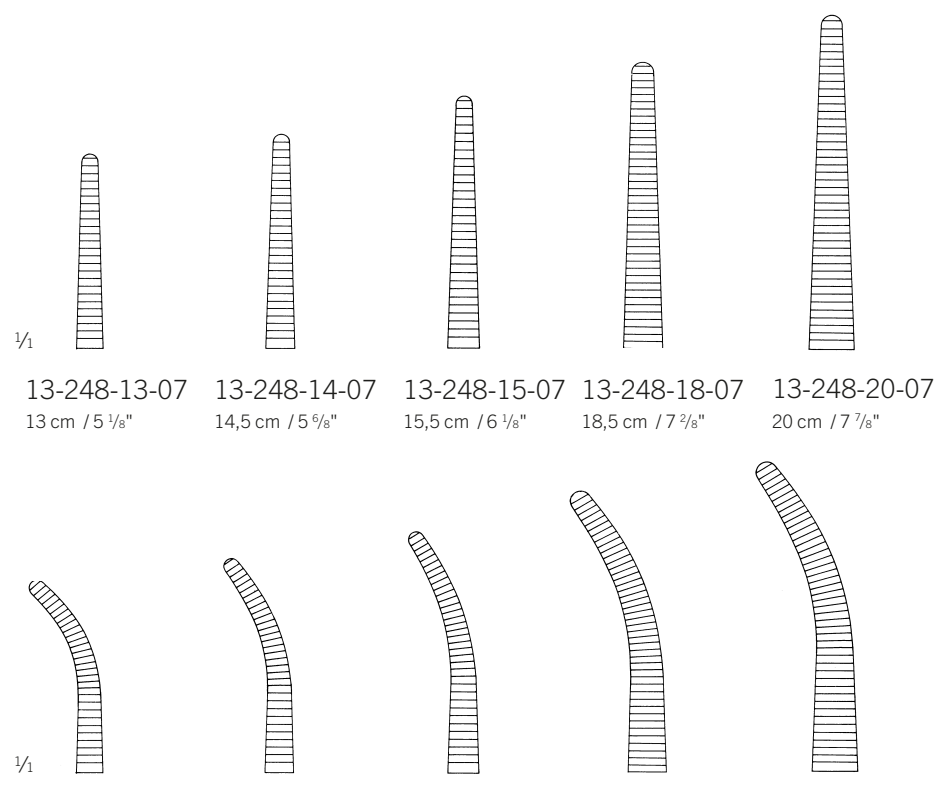


13-176-14-07 13-176-16-07  
14,5 cm / 5 9/16" 16 cm / 6 3/8"

Pean  
13-176-14-07 -  
13-176-16-07



1/2



|                                |                                   |                                  |                                  |                                |
|--------------------------------|-----------------------------------|----------------------------------|----------------------------------|--------------------------------|
| 13-248-13-07<br>13 cm / 5 1/8" | 13-248-14-07<br>14,5 cm / 5 9/16" | 13-248-15-07<br>15,5 cm / 6 1/8" | 13-248-18-07<br>18,5 cm / 7 3/8" | 13-248-20-07<br>20 cm / 7 7/8" |
| 13-249-13-07<br>13 cm / 5 1/8" | 13-249-14-07<br>14 cm / 5 4/8"    | 13-249-15-07<br>15 cm / 5 7/8"   | 13-249-18-07<br>18 cm / 7 1/8"   | 13-249-20-07<br>20 cm / 7 7/8" |

Spencer-Wells  
13-248-13-07 -  
13-249-20-07

## Arterienklemmen, Organfasszangen

Haemostatic Forceps, Organ Grasping Forceps  
 Pinzas hemostáticas, Pinzas para sacar órganos  
 Pinces hémostatiques, Pinces pour saisir organes  
 Pinze emostatiche, Pinze per afferrare organi

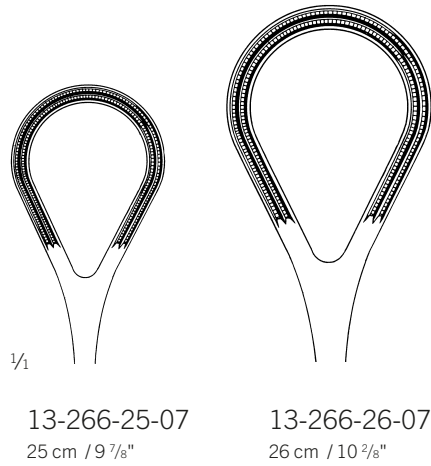
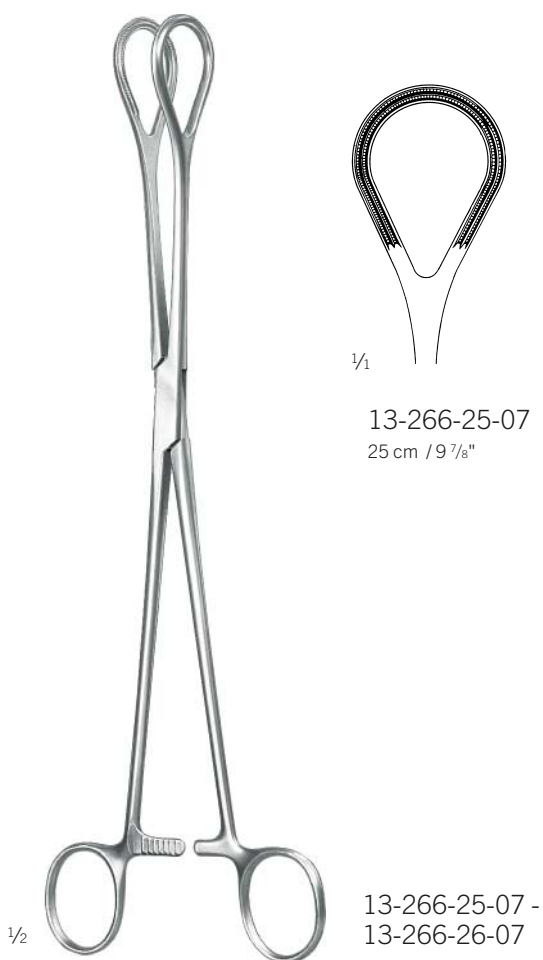


Chaput  
 13-256-13-07  
 12,5 cm / 4 7/8"



Tuffier  
 13-258-13-07  
 12,5 cm / 4 7/8"

## Atrauma



13-266-25-07 -  
 13-266-26-07

## Organfasszangen

Organ Grasping Forceps  
Pinzas para sacar órganos  
Pincés pour saisir organes  
Pinze per afferrare organi

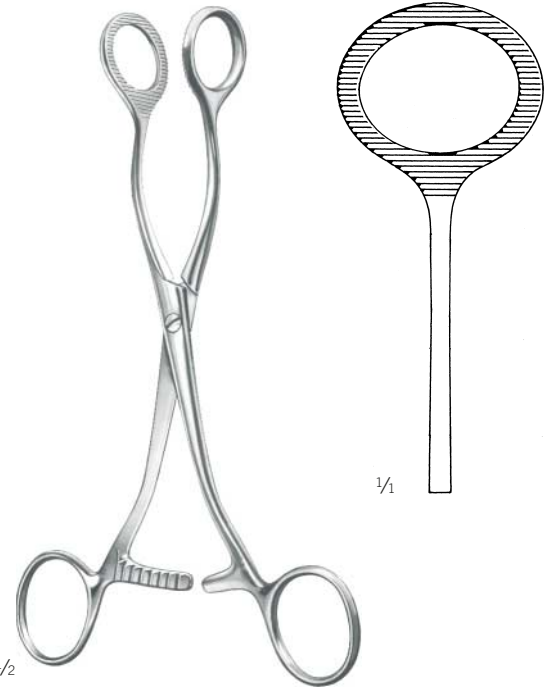
## Arterienklemmen

Haemostatic Forceps  
Pinzas hemostáticas  
Pincés hémostatiques  
Pinze emostatiche



1/2

Collin  
13-268-14-07  
14 cm / 5 1/8"



1/2

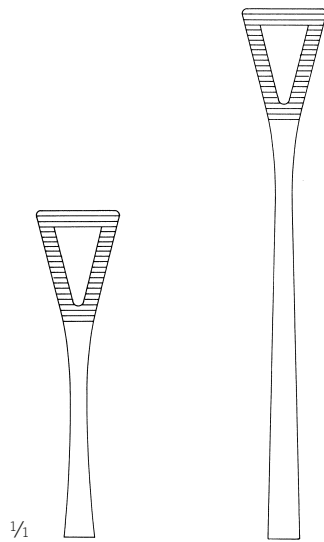
Collin  
13-278-17-07  
17 cm / 6 5/8"

Tumorfasszange  
Tumor Grasping Forceps  
Pinzas para sacar órganos  
Pincés à tumeurs à vis  
Pinze per afferrare tumori



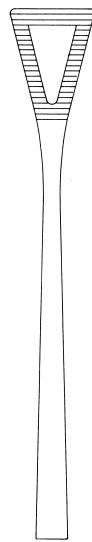
1/2

Pennington  
13-280-15-07 -  
13-280-20-07



1/2

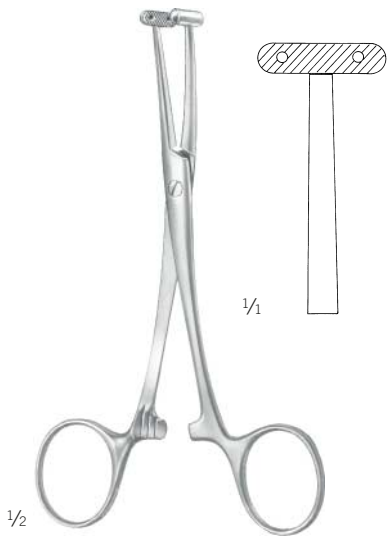
13-280-15-07  
15,5 cm / 6 1/8"



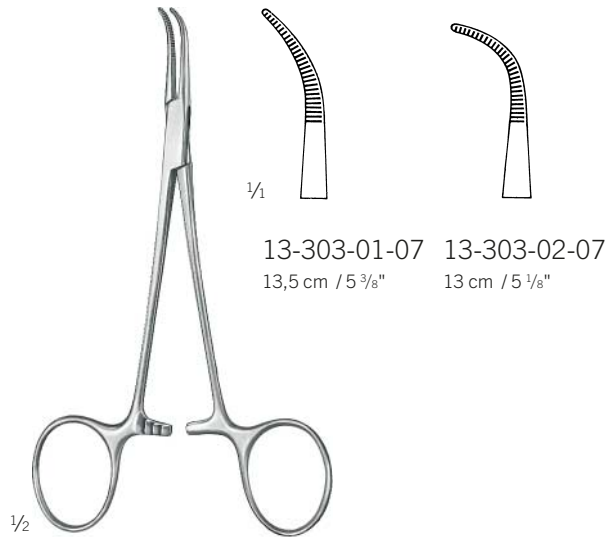
13-280-20-07  
21 cm / 8 2/8"

## Arterienklemmen, Präparierklemmen

Haemostatic Forceps, Dissecting and Ligature Forceps  
Pinzas hemostáticas, Pinzas para preparación y ligadura  
Pinces hémostatiques, Pinces à dissecquer et à ligatures  
Pinze emostatiche, Pinze per preparazioni e legature



Martel-Rees  
13-290-14-07  
13,5 cm / 5 3/8"  
Face-lift-Klemme  
Face-lift Forceps  
Pinza para Face-lift  
Pinces pour Face-lift  
Pinze per Face-lift



13-303-01-07 13-303-02-07  
13,5 cm / 5 3/8" 13 cm / 5 1/8"

Mixer-Baby  
13-303-01-07 -  
13-303-02-07



Mikro-Adson  
13-304-14-07  
14 cm / 5 4/8"



Baby-Adson  
13-305-18-07  
18 cm / 7 1/8"

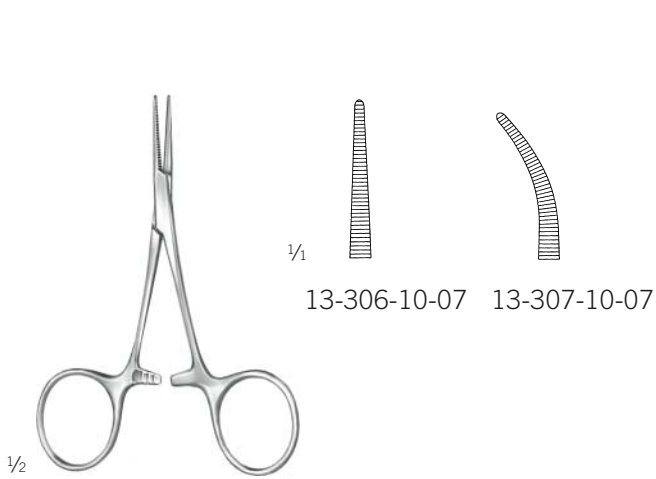
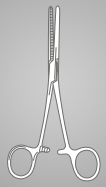


## Arterienklemmen

Haemostatic Forceps  
Pinzas hemostáticas  
Pincas hémostatiques  
Pinze emostatiche

## Arterienklemmen

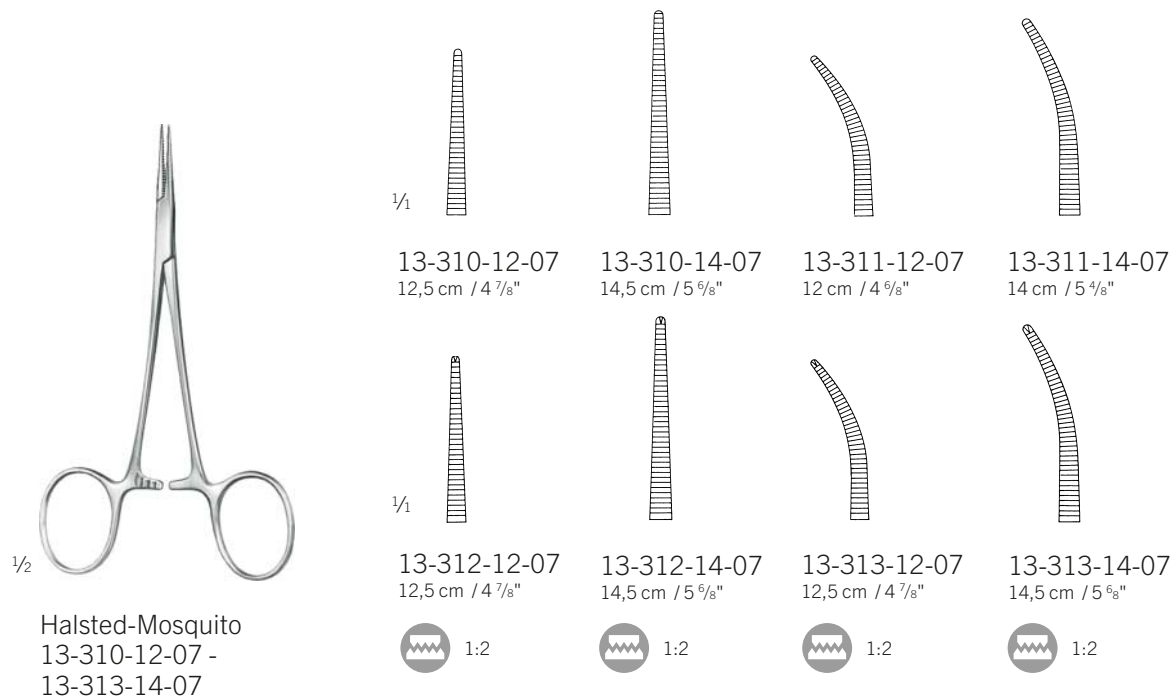
Haemostatic Forceps  
Pinzas hemostáticas  
Pincas hémostatiques  
Pinze emostatiche



Hartmann  
13-306-10-07 -  
13-307-10-07  
10 cm / 3 7/8"



13-309-12-07  
12 cm / 4 5/8"  
Fadenklemme  
Ligature Forceps  
Pinza para hilos  
Pince à ligatures  
Pinza per legature



Halsted-Mosquito  
13-310-12-07 -  
13-313-14-07



# Arterienklemmen

Haemostatic Forceps  
Pinzas hemostáticas  
Pinces hémostatiques  
Pinze emostatiche

Ti



1/2

Halsted-Mosquito  
13-310-62-09 -  
13-313-62-09

|     |                                  |                                |                                |                                |
|-----|----------------------------------|--------------------------------|--------------------------------|--------------------------------|
| 1/1 |                                  |                                |                                |                                |
|     | 13-310-62-09<br>12,5 cm / 4 7/8" | 13-311-62-09<br>12 cm / 4 6/8" | 13-312-62-09<br>12 cm / 4 6/8" | 13-313-62-09<br>12 cm / 4 6/8" |
|     |                                  |                                | 1:2                            | 1:2                            |



1/2

Halsted-Mosquito  
13-316-18-07 -  
13-319-21-07

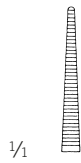
|     |                                  |                                |                                |                                  |
|-----|----------------------------------|--------------------------------|--------------------------------|----------------------------------|
| 1/1 |                                  |                                |                                |                                  |
|     | 13-316-18-07<br>18,5 cm / 7 2/8" | 13-316-21-07<br>21 cm / 8 2/8" | 13-317-18-07<br>18 cm / 7 1/8" | 13-317-21-07<br>20,5 cm / 8 1/8" |
| 1/1 |                                  |                                |                                |                                  |
|     | 13-318-18-07<br>18,5 cm / 7 2/8" | 13-318-21-07<br>21 cm / 8 2/8" | 13-319-18-07<br>18 cm / 7 1/8" | 13-319-21-07<br>20,5 cm / 8 1/8" |
|     | 1:2                              | 1:2                            | 1:2                            | 1:2                              |

## Arterienklemmen

Haemostatic Forceps  
Pinzas hemostáticas  
Pincas hémostatiques  
Pinze emostatiche

## Arterienklemmen

Haemostatic Forceps  
Pinzas hemostáticas  
Pincas hémostatiques  
Pinze emostatiche



1/1

13-320-10-07  
10 cm / 3 7/8"



13-320-12-07  
12 cm / 4 6/8"



13-321-10-07  
10 cm / 3 7/8"

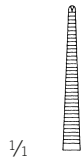


13-321-12-07  
12 cm / 4 6/8"



1/2

Mikro-Mosquito  
13-320-10-07 -  
13-323-12-07



1/1

13-322-10-07  
10 cm / 3 7/8"



13-322-12-07  
12 cm / 4 6/8"



13-323-10-07  
10 cm / 3 7/8"



13-323-12-07  
12 cm / 4 6/8"



1:2



1:2



1:2

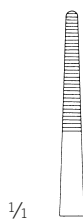


1:2



1/2

Providence-Hospital  
13-324-14-07 -  
13-325-14-07



1/1

13-324-14-07  
14 cm / 5 4/8"

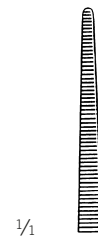


13-325-14-07  
13,5 cm / 5 3/8"



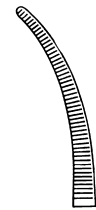
1/2

Leriche  
13-326-15-07 -  
13-329-15-07



1/1

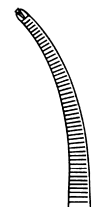
13-326-15-07  
15,5 cm / 6 1/8"



13-327-15-07  
15 cm / 5 7/8"



13-328-15-07  
15,5 cm / 6 1/8"



13-329-15-07  
15 cm / 5 7/8"



1:2



1:2

## Arterienklemmen

Haemostatic Forceps

Pinzas hemostáticas

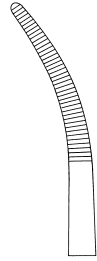
Pinces hémostatiques

Pinze emostatiche



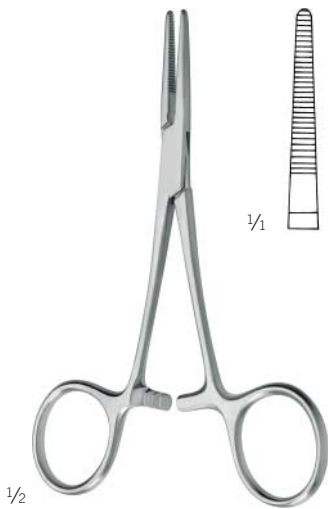
1/1

13-330-14-07  
14,5 cm / 5 7/8"



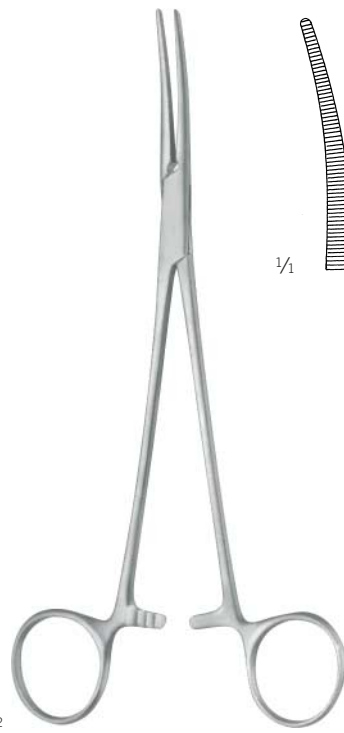
13-331-14-07  
14 cm / 5 4/8"

Kelly  
13-330-14-07 -  
13-331-14-07



1/1

Dunhill  
13-332-12-07  
12,5 cm / 4 7/8"



1/1

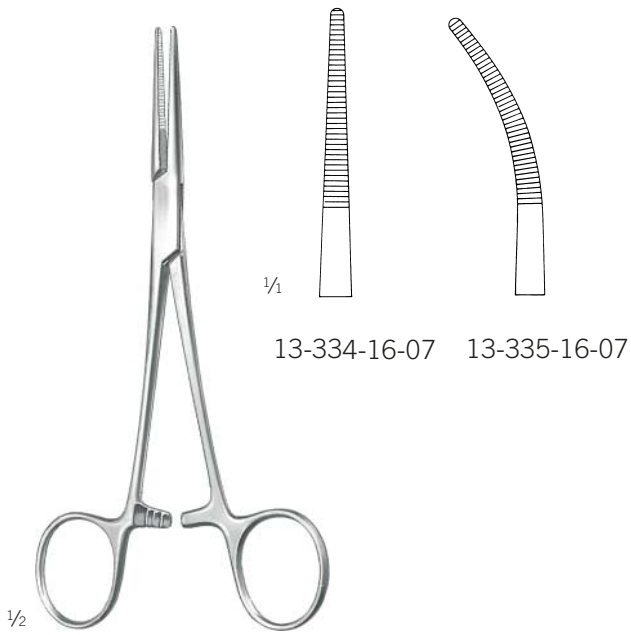
Dunhill  
13-333-19-07  
18,5 cm / 7 2/8"

## Arterienklemmen, Präparierklemmen

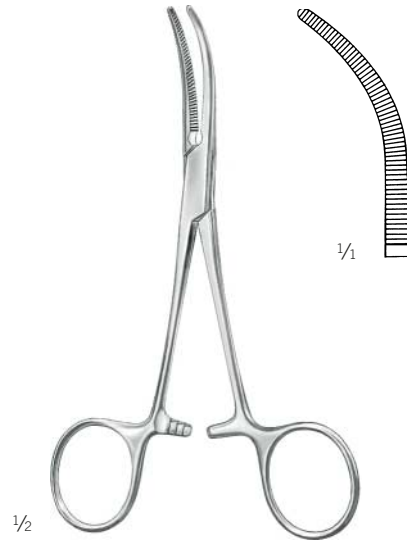
Haemostatic Forceps, Dissecting and Ligature Forceps  
 Pinzas hemostáticas, Pinzas para preparación y ligadura  
 Pincas hémostatiques, Pincas à dissecquer et à ligatures  
 Pinze emostatiche, Pinze per preparazioni e legature

## Arterienklemmen

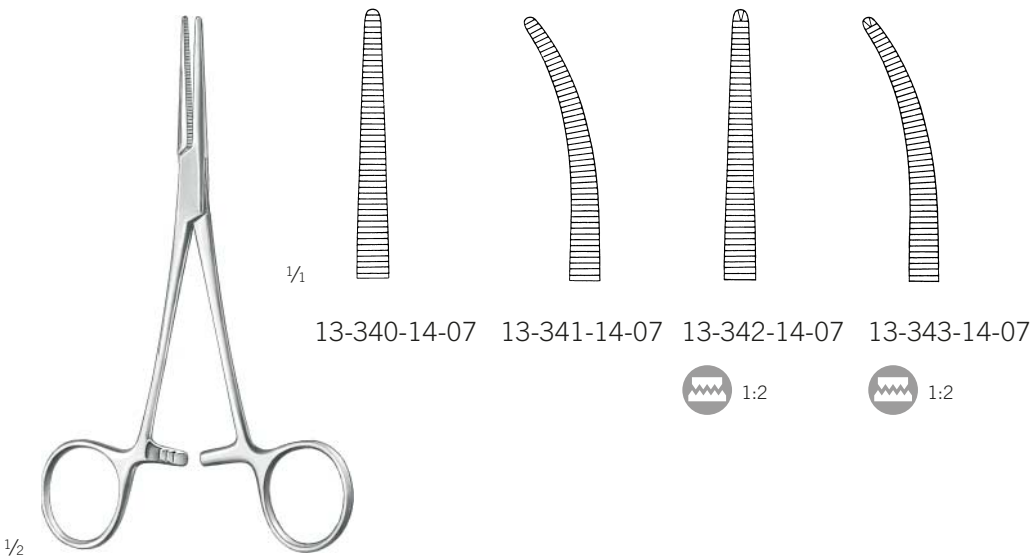
Haemostatic Forceps  
 Pinzas hemostáticas  
 Pincas hémostatiques  
 Pinze emostatiche



13-334-16-07 13-335-16-07



Overholt-Baby  
 13-339-14-07  
 13,5 cm / 5 3/8"



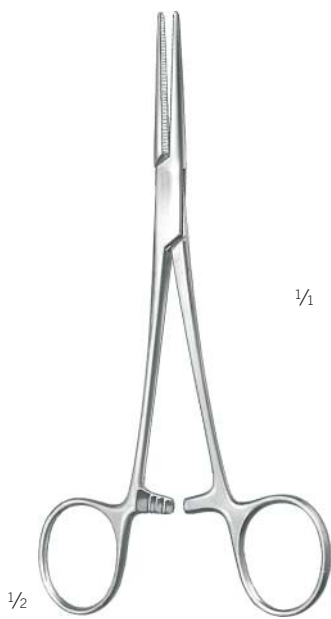
13-340-14-07 13-341-14-07 13-342-14-07 13-343-14-07



Crile  
 13-340-14-07 -  
 13-343-14-07  
 14,5 cm / 5 7/8"

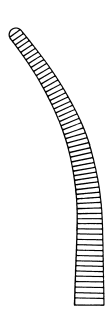
## Arterienklemmen

Haemostatic Forceps  
Pinzas hemostáticas  
Pincas hémostatiques  
Pinze emostatiche



1/2

13-346-16-07



13-347-16-07

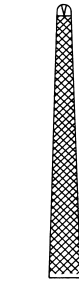
Crile-Rankin  
13-346-16-07 -  
13-347-16-07  
16 cm / 6 2/8"



1/2

1/2

13-348-15-07



13-350-15-07

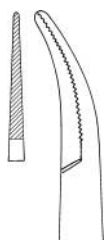


Lovelace  
13-348-15-07 -  
13-350-15-07  
16 cm / 6 2/8"

kreuzgerieftes Maul  
cross serrated jaw  
boca estriada en forma de cruz  
mors à rainures croisées  
morso con striatura cruciforme

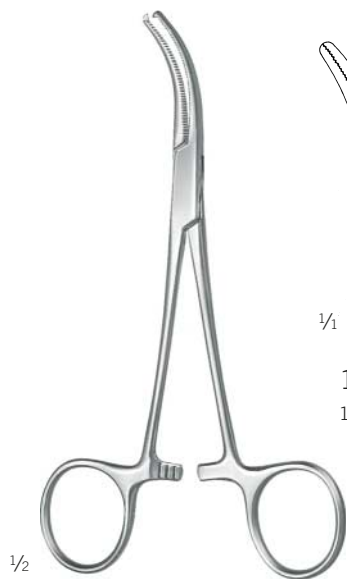


1/2

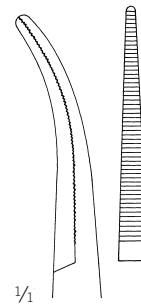


Dandy-Mosquito  
13-351-12-07  
12 cm / 4 6/8"

seitlich gebogen  
laterally curved  
curva lateralmente  
courbe lateralement  
curva laterale

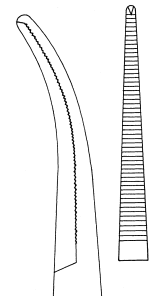


1/2



1/2

13-355-14-07  
14,5 cm / 5 6/8"



13-357-14-07  
14 cm / 5 4/8"



Dandy  
13-355-14-07 -  
13-357-14-07

seitlich gebogen  
laterally curved  
curva lateralmente  
courbe lateralement  
curva laterale

## Arterienklemmen, Präparierklemmen

Haemostatic Forceps, Dissecting and Ligature Forceps  
 Pinzas hemostáticas, Pinzas para preparación y ligadura  
 Pincas hémostatiques, Pincas à dissecquer et à ligatures  
 Pinze emostatiche, Pinze per preparazioni e legature

## Arterienklemmen

Haemostatic Forceps  
 Pinzas hemostáticas  
 Pincas hémostatiques  
 Pinze emostatiche

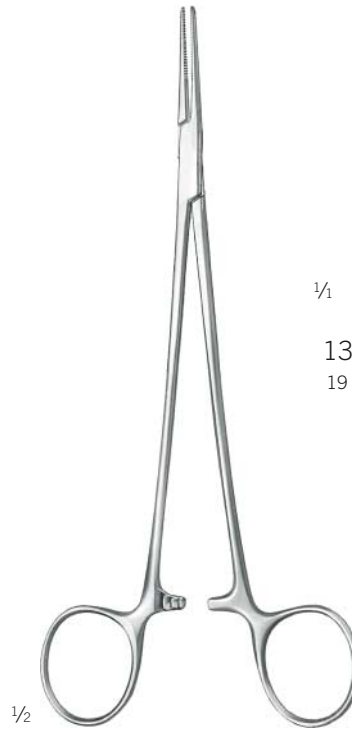


1/1

13-363-18-07  
 18,5 cm / 7 3/8"

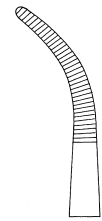


13-363-19-07  
 19 cm / 7 4/8"



1/1

13-364-18-07  
 19 cm / 7 4/8"



13-365-18-07  
 18,5 cm / 7 2/8"

Schnidt  
 13-363-18-07 -  
 13-363-19-07

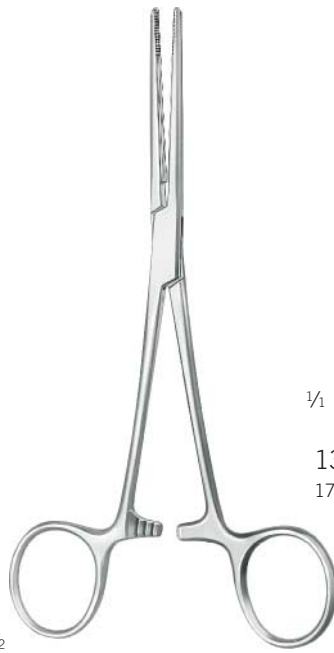
Adson  
 13-364-18-07 -  
 13-365-18-07

13



1/1

Martin-Fuchsig  
 13-369-20-07  
 20,5 cm / 8 1/8"

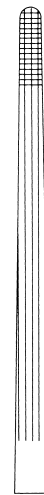


1/2

Rochester-Carmalt  
 13-370-16-07 -  
 13-371-20-07

1/1

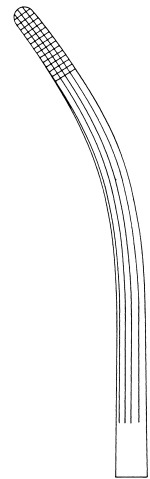
13-370-16-07  
 17 cm / 6 6/8"



13-370-20-07  
 20,5 cm / 8 1/8"



13-371-16-07  
 16,5 cm / 6 4/8"



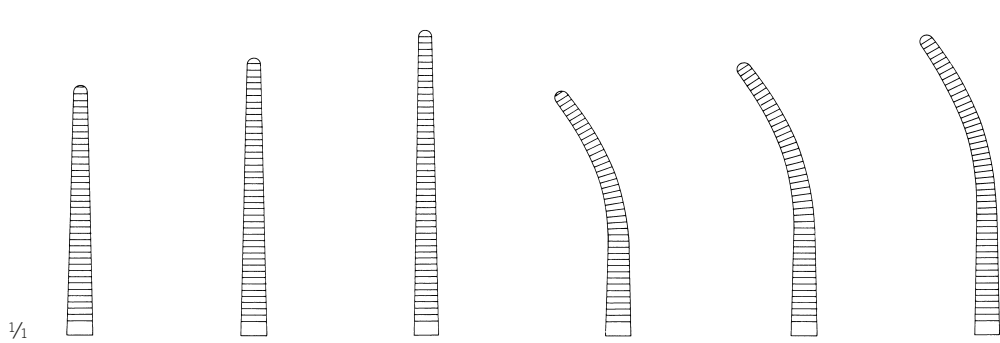
13-371-20-07  
 20 cm / 7 7/8"

## Arterienklemmen

Haemostatic Forceps  
Pinzas hemostáticas  
Pincès hémostatiques  
Pinze emostatiche



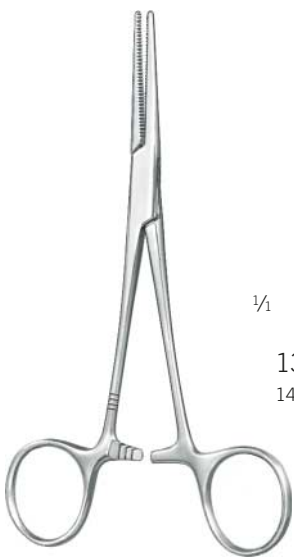
1/2



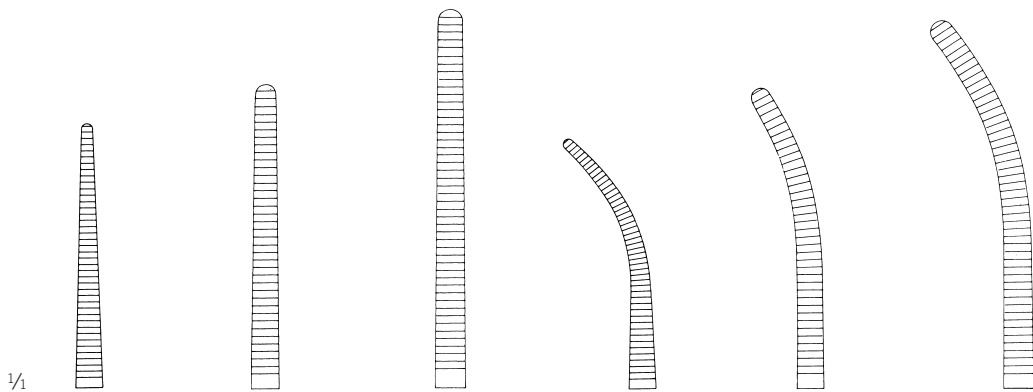
1/4

|                  |                  |                |                |                |                  |
|------------------|------------------|----------------|----------------|----------------|------------------|
| 13-374-13-07     | 13-374-14-07     | 13-374-16-07   | 13-375-13-07   | 13-375-14-07   | 13-375-16-07     |
| 13,5 cm / 5 3/8" | 14,5 cm / 5 7/8" | 17 cm / 6 5/8" | 13 cm / 5 1/8" | 14 cm / 5 4/8" | 16,5 cm / 6 4/8" |

Pean  
13-374-13-07 -  
13-375-16-07



1/2



1/4

|                  |                  |                  |                |                |                |
|------------------|------------------|------------------|----------------|----------------|----------------|
| 13-380-14-07     | 13-380-16-07     | 13-380-18-07     | 13-381-14-07   | 13-381-16-07   | 13-381-18-07   |
| 14,5 cm / 5 6/8" | 16,5 cm / 6 4/8" | 18,5 cm / 7 2/8" | 14 cm / 5 4/8" | 16 cm / 6 2/8" | 18 cm / 7 1/8" |

Pean-Nippon  
13-380-14-07 -  
13-381-18-07

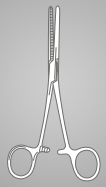


## Arterienklemmen

Haemostatic Forceps  
Pinzas hemostáticas  
Pincès hémostatiques  
Pinze emostatiche

## Arterienklemmen

Haemostatic Forceps  
Pinzas hemostáticas  
Pincès hémostatiques  
Pinze emostatiche



13

1/2

1/4

|                   |                  |                  |                |                |                |
|-------------------|------------------|------------------|----------------|----------------|----------------|
| 13-382-14-07      | 13-382-16-07     | 13-382-18-07     | 13-383-14-07   | 13-383-16-07   | 13-383-18-07   |
| 14,5 cm / 5 9/16" | 16,5 cm / 6 4/8" | 18,5 cm / 7 2/8" | 14 cm / 5 4/8" | 16 cm / 6 2/8" | 18 cm / 7 1/8" |
| 1:2               | 1:2              | 1:2              | 1:2            | 1:2            | 1:2            |

Kocher-Nippon  
13-382-14-07 -  
13-383-18-07

1/2

1/4

|                |                |                |                |                |                |
|----------------|----------------|----------------|----------------|----------------|----------------|
| 13-384-13-07   | 13-384-14-07   | 13-384-16-07   | 13-385-13-07   | 13-385-14-07   | 13-385-16-07   |
| 13 cm / 5 1/8" | 14 cm / 5 4/8" | 16 cm / 6 2/8" | 13 cm / 5 1/8" | 14 cm / 5 4/8" | 16 cm / 6 2/8" |
| 1:2            | 1:2            | 1:2            | 1:2            | 1:2            | 1:2            |

Kocher  
13-384-13-07 -  
13-385-16-07

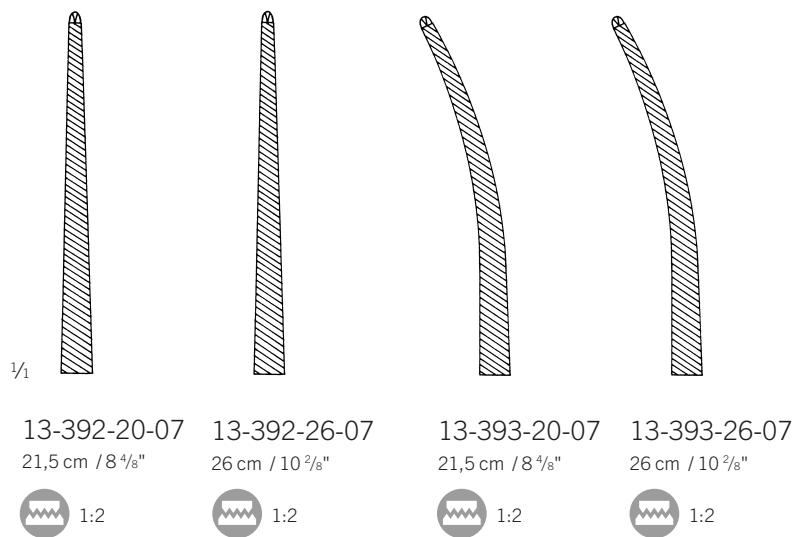
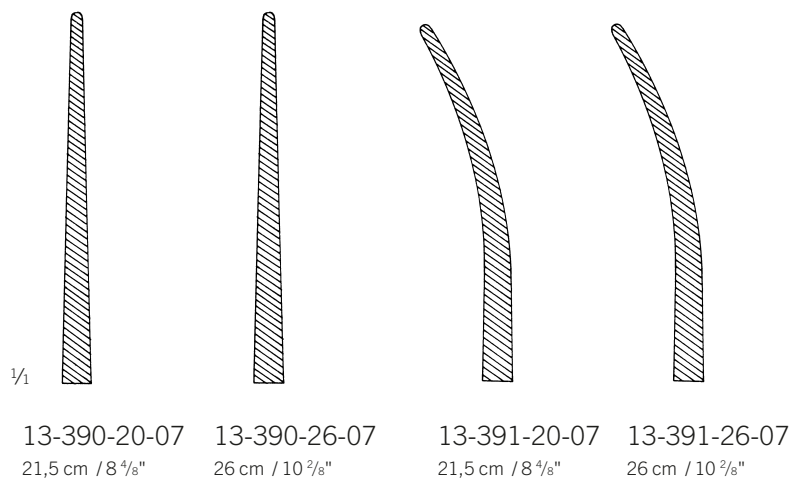
## Arterienklemmen

Haemostatic Forceps

Pinzas hemostáticas

Pinces hémostatiques

Pinze emostatiche



Bengolea  
13-390-20-07 -  
13-393-26-07

## Arterienklemmen

Haemostatic Forceps  
Pinzas hemostáticas  
Pincas hémostatiques  
Pinze emostatiche

## Arterienklemmen

Haemostatic Forceps  
Pinzas hemostáticas  
Pincas hémostatiques  
Pinze emostatiche



13

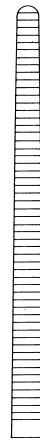
1/1



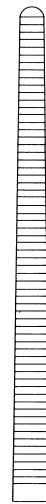
13-410-14-07  
14,5 cm / 5 7/8"



13-410-16-07  
16,5 cm / 6 4/8"



13-410-18-07  
18,5 cm / 7 3/8"



13-410-20-07  
20,5 cm / 8 1/8"

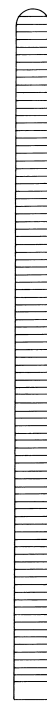
1/1



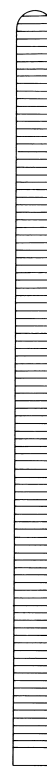
13-410-22-07  
22,5 cm / 8 7/8"



13-410-24-07  
24 cm / 9 4/8"



13-410-26-07  
26 cm / 10 2/8"



13-410-30-07  
31 cm / 12 2/8"

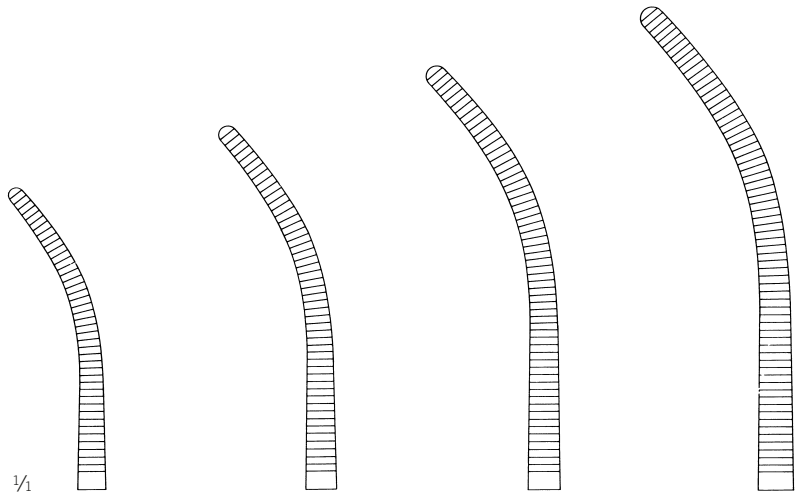
1/2



Pean (Rochester)  
13-410-14-07 -  
13-410-30-07

## Arterienklemmen

Haemostatic Forceps  
Pinzas hemostáticas  
Pincas hémostatiques  
Pinze emostatiche



1/1

13-411-14-07  
14 cm / 5 1/8"

13-411-16-07  
16,5 cm / 6 4/8"

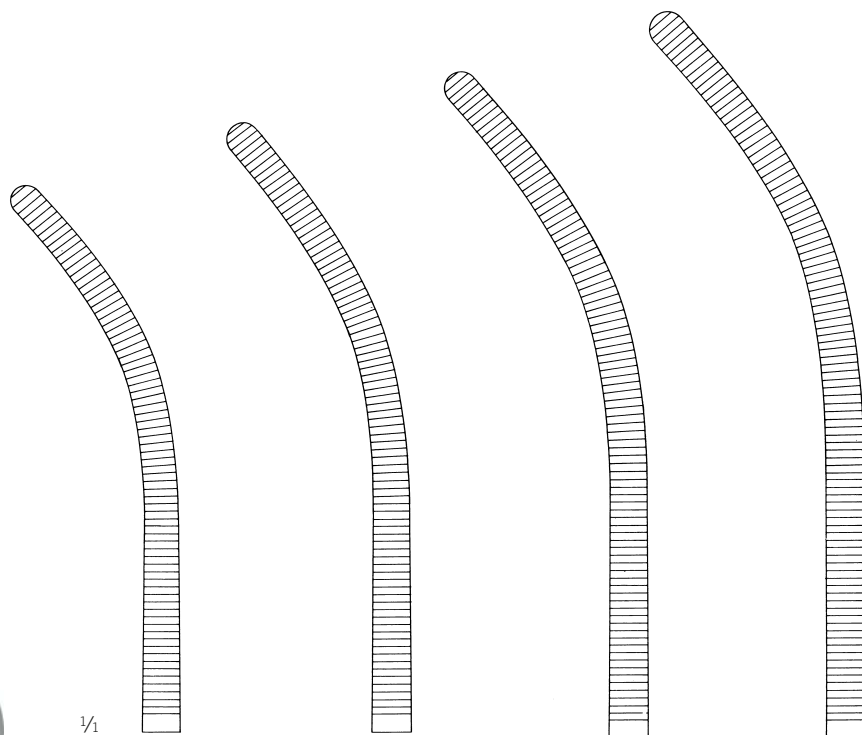
13-411-18-07  
18,5 cm / 7 2/8"

13-411-20-07  
20,5 cm / 8 1/8"



1/2

Pean (Rochester)  
13-411-14-07 -  
13-411-30-07



1/1

13-411-22-07  
22 cm / 8 5/8"

13-411-24-07  
24 cm / 9 4/8"

13-411-26-07  
26 cm / 10 2/8"

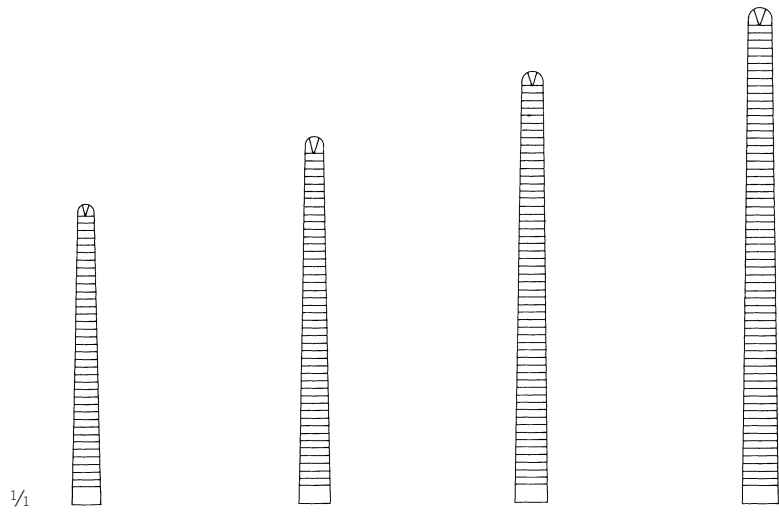
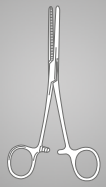
13-411-30-07  
30,5 cm / 12"

## Arterienklemmen

Haemostatic Forceps  
Pinzas hemostáticas  
Pincas hémostatiques  
Pinze emostatiche

## Arterienklemmen

Haemostatic Forceps  
Pinzas hemostáticas  
Pincas hémostatiques  
Pinze emostatiche



1/1

13-414-14-07  
14,5 cm / 5 6/8"



13-414-16-07  
16,5 cm / 6 4/8"



13-414-18-07  
18,5 cm / 7 2/8"

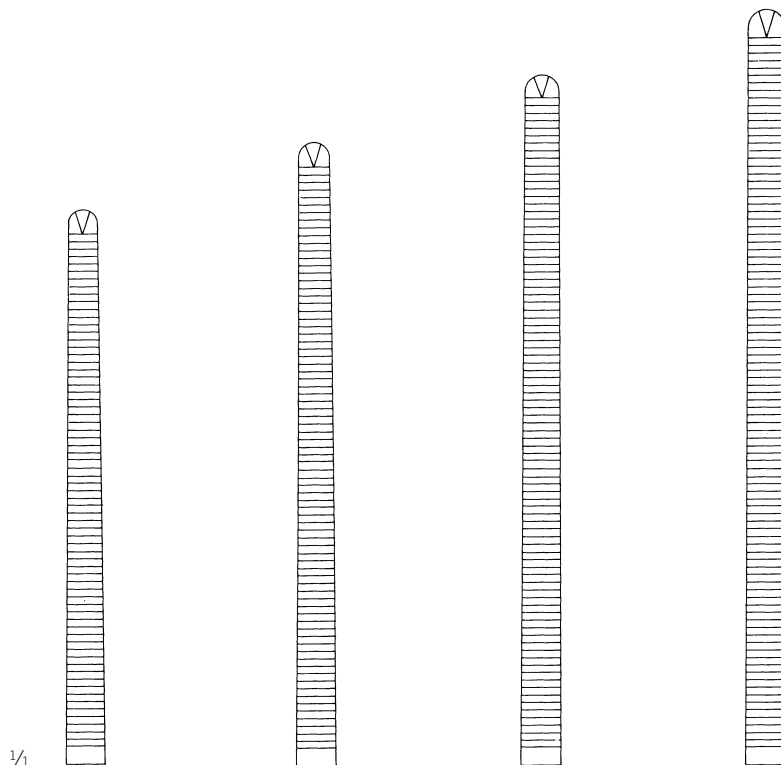


13-414-20-07  
20,5 cm / 8 1/8"



1/2

Kocher (Ochsner)  
13-414-14-07 -  
13-414-30-07



1/1

13-414-22-07  
22,5 cm / 8 7/8"



13-414-24-07  
24 cm / 9 4/8"



13-414-26-07  
26 cm / 10 2/8"



13-414-30-07  
31 cm / 12 2/8"



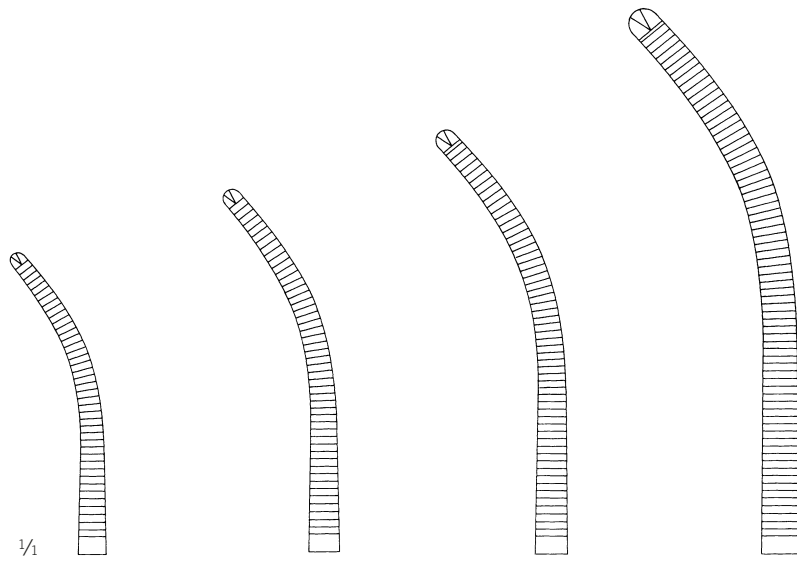
## Arterienklemmen

Haemostatic Forceps

Pinzas hemostáticas

Pinces hémostatiques

Pinze emostatiche



1/4

13-415-14-07

14 cm / 5 4/8"



13-415-16-07

16,5 cm / 6 4/8"



13-415-18-07

18,5 cm / 7 2/8"



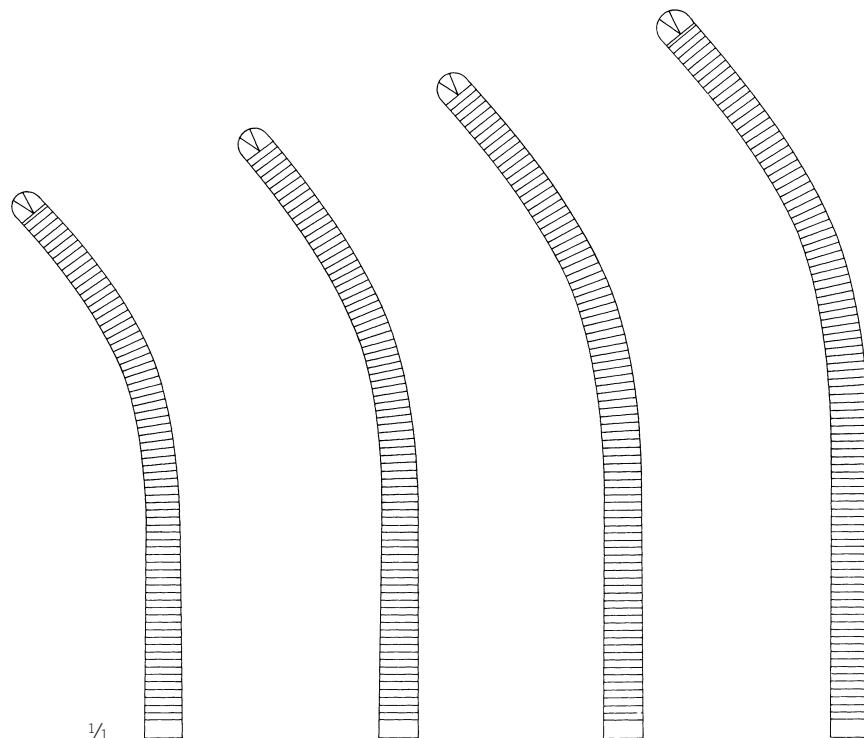
13-415-20-07

20 cm / 7 7/8"



1/2

Kocher (Ochsner)  
13-415-14-07 -  
13-415-30-07



1/4

13-415-22-07

22,5 cm / 8 7/8"



13-415-24-07

24 cm / 9 4/8"



13-415-26-07

26 cm / 10 2/8"



13-415-30-07

30,5 cm / 12"



## Präparierklemmen

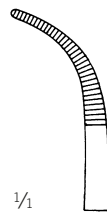
Dissecting and Ligature Forceps  
Pinzas para preparación y ligadura  
Pinces à disséquer et à ligatures  
Pinze per preparazioni e legature

## Arterienklemmen

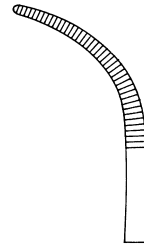
Haemostatic Forceps  
Pinzas hemostáticas  
Pinces hémostatiques  
Pinze emostatiche



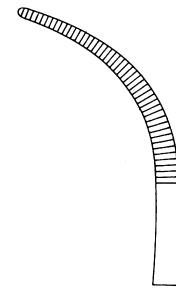
1/1



**Fig. 1**  
13-417-01-07  
18,5 cm / 7 3/8"

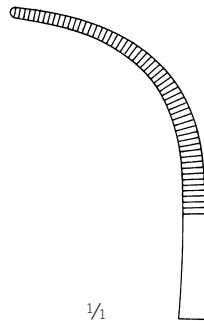


**Fig. 2**  
13-417-02-07  
20,5 cm / 8 1/8"

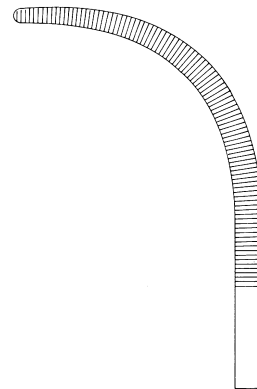


**Fig. 3**  
13-417-03-07  
21cm / 8 2/8"

1/1



**Fig. 4**  
13-417-04-07  
21,5 cm / 8 2/8"



**Fig. 5**  
13-417-05-07  
24,5 cm / 9 6/8"

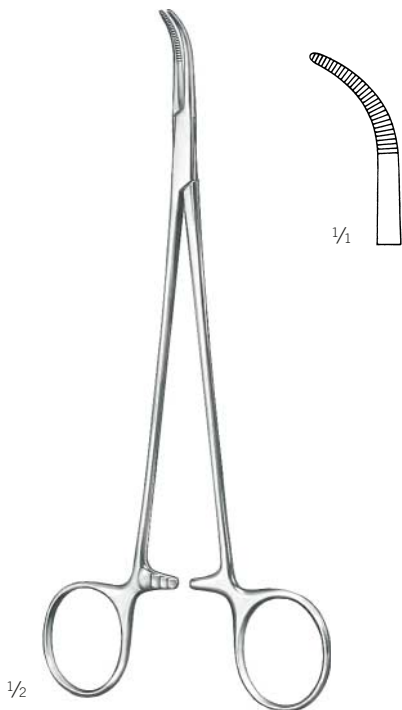
1/2



Overholt-Martin  
13-417-01-07 -  
13-417-05-07

## Präparierklemmen

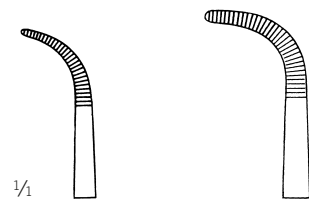
Dissecting and Ligature Forceps  
 Pinzas para preparación y ligadura  
 Pincès à disséquer et à ligatures  
 Pinze per preparazioni e legature



Mixer-Baby  
 13-419-18-07  
 18,5 cm / 7 3/8"



Adson-Baby  
 13-421-14-07 -  
 13-421-18-07

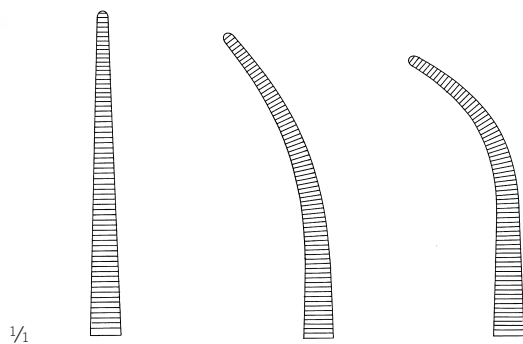


13-421-14-07  
 14,5 cm / 5 5/8"

13-421-18-07  
 18 cm / 7 1/8"



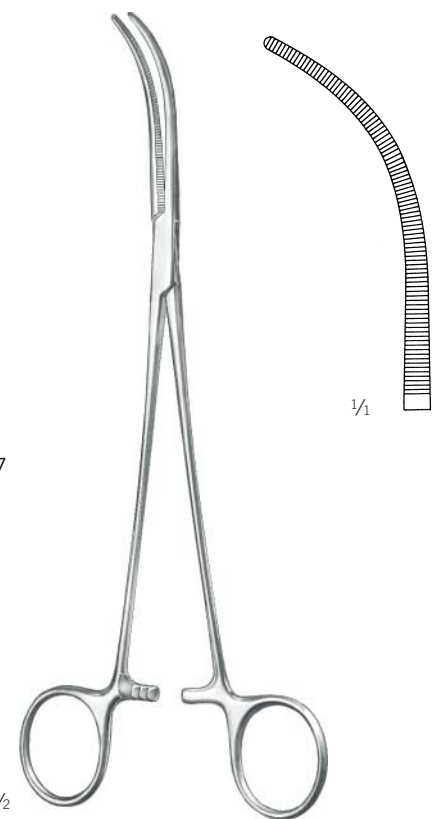
Heiss  
 13-422-20-07 -  
 13-425-20-07



13-422-20-07  
 21 cm / 8 2/8"

13-423-20-07  
 20,5 cm / 8 1/8"

13-425-20-07  
 21 cm / 8 2/8"



Overholt-Mixer  
 13-427-21-07  
 22 cm / 8 5/8"

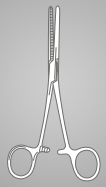


## Präparierklemmen

Dissecting and Ligature Forceps  
Pinzas para preparación y ligadura  
Pincès à disséquer et à ligatures  
Pinze per preparazioni e legature

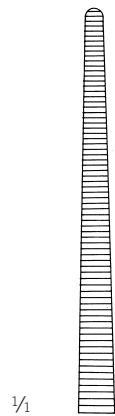
## Arterienklemmen

Haemostatic Forceps  
Pinzas hemostáticas  
Pincès hémostatiques  
Pinze emostatiche



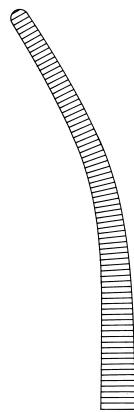
1/2

Roberts  
13-428-22-07 -  
13-429-22-07



1/1

13-428-22-07  
22,5 cm / 8 7/8"

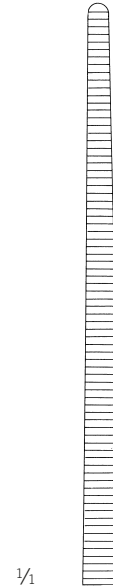


13-429-22-07  
22 cm / 8 5/8"



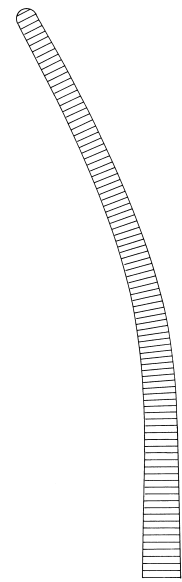
1/2

Sarot  
13-432-24-07 -  
13-433-24-07



1/1

13-432-24-07  
25 cm / 9 7/8"



13-433-24-07  
24,5 cm / 9 5/8"

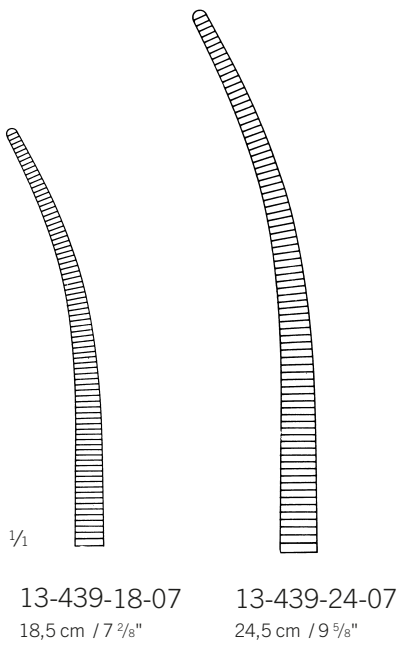
## Präparierklemmen

Dissecting and Ligature Forceps  
Pinzas para preparación y ligadura  
Pinces à disséquer et à ligatures  
Pinze per preparazioni e legature



1/2

Crafoord  
13-439-18-07 -  
13-439-24-07

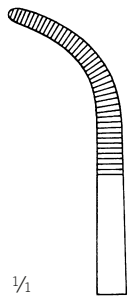


## Präparierklemmen

Dissecting and Ligature Forceps  
 Pinzas para preparación y ligadura  
 Pincas à disséquer et à ligatures  
 Pinze per preparazioni e legature

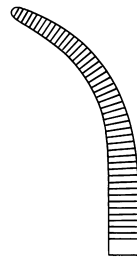
## Arterienklemmen

Haemostatic Forceps  
 Pinzas hemostáticas  
 Pincas hémostatiques  
 Pinze emostatiche

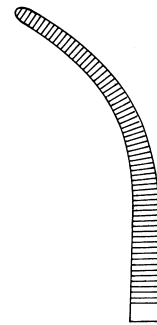


1/1

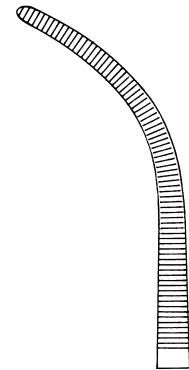
**Fig. 1**  
 13-443-01-07  
 20,5 cm / 8 1/8"



**Fig. 2**  
 13-443-02-07  
 20 cm / 7 7/8"



**Fig. 3**  
 13-443-03-07  
 21,5 cm / 8 4/8"



**Fig. 4**  
 13-443-04-07  
 22 cm / 8 5/8"

13-447-01-07  
 27 cm / 10 5/8"

13-447-02-07  
 26,5 cm / 10 3/8"

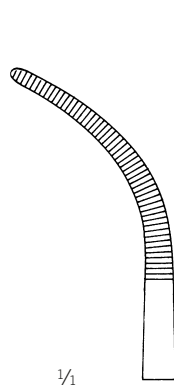
13-447-03-07  
 27,5 cm / 10 7/8"

13-447-04-07  
 28 cm / 11"



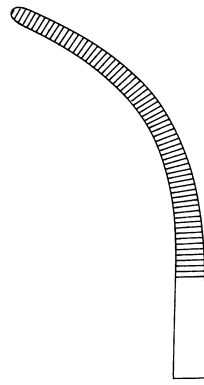
1/2

Overholt-Geissendörfer  
 13-443-01-07 -  
 13-447-07-07



1/1

**Fig. 5**  
 13-443-05-07  
 21,5 cm / 8 4/8"



**Fig. 6**  
 13-443-06-07  
 21,5 cm / 8 5/8"



**Fig. 7**  
 13-443-07-07  
 22 cm / 8 5/8"

13-447-05-07  
 27,5 cm / 10 7/8"

13-447-06-07  
 28 cm / 11"

13-447-07-07  
 27,5 cm / 10 7/8"

## Präparierklemmen

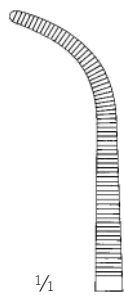
Dissecting and Ligature Forceps  
Pinzas para preparación y ligadura  
Pinces à disséquer et à ligatures  
Pinze per preparazioni e legature

finoLine



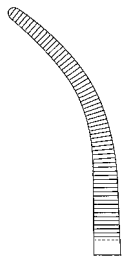
1/2

Overholt-Fino  
13-448-00-07 -  
13-448-06-07

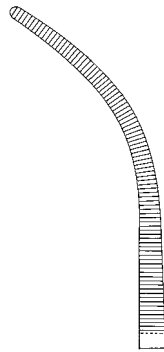


1/1

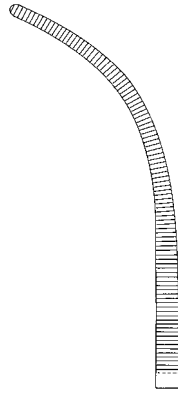
13-448-00-07  
21,5 cm / 8 4/8"



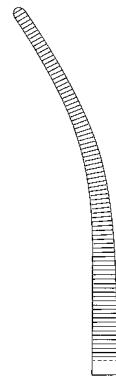
13-448-01-07  
22 cm / 8 5/8"



13-448-02-07  
22,5 cm / 8 7/8"



13-448-03-07  
23 cm / 9"



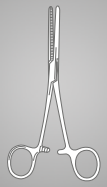
13-448-06-07  
22,5 cm / 8 7/8"

## Präparierklemmen

Dissecting and Ligature Forceps  
Pinzas para preparación y ligadura  
Pinces à disséquer et à ligatures  
Pinze per preparazioni e legature

## Arterienklemmen

Haemostatic Forceps  
Pinzas hemostáticas  
Pinces hémostatiques  
Pinze emostatiche



13



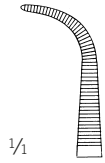
## Präparierklemmen

Dissecting and Ligature Forceps  
 Pinzas para preparación y ligadura  
 Pinces à disséquer et à ligatures  
 Pinze per preparazioni e legature



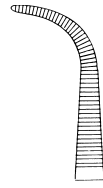
1/2

Gemini  
 13-451-13-07 -  
 13-451-28-07

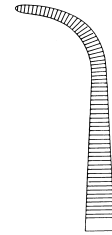


1/4

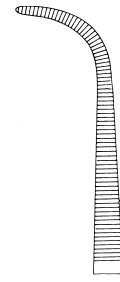
13-451-13-07  
 13 cm / 5 1/8"



13-451-16-07  
 16 cm / 6 2/8"



13-451-18-07  
 18 cm / 7 1/8"



13-451-20-07  
 21 cm / 8 2/8"

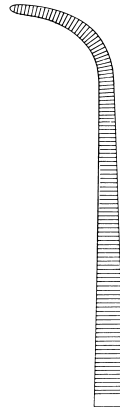


1/4

13-451-23-07  
 23 cm / 9"



13-451-25-07  
 25 cm / 9 7/8"

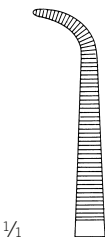


13-451-28-07  
 28 cm / 11"



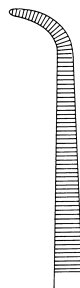
1/2

Mini-Gemini  
 13-453-18-07 -  
 13-453-28-07

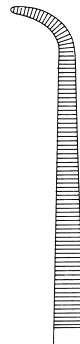


1/4

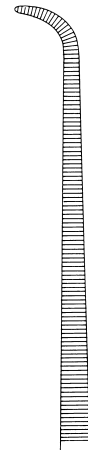
13-453-18-07  
 18 cm / 7 1/8"



13-453-22-07  
 23 cm / 9"



13-453-25-07  
 25 cm / 9 7/8"



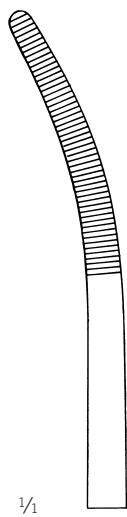
13-453-28-07  
 28,5 cm / 11 2/8"

## Präparierklemmen

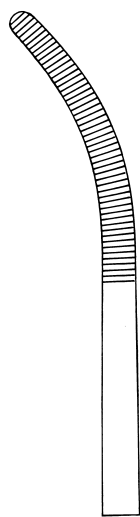
Dissecting and Ligature Forceps  
Pinzas para preparación y ligadura  
Pinces à disséquer et à ligatures  
Pinze per preparazioni e legature

## Arterienklemmen

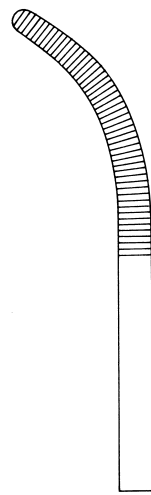
Haemostatic Forceps  
Pinzas hemostáticas  
Pinces hémostatiques  
Pinze emostatiche



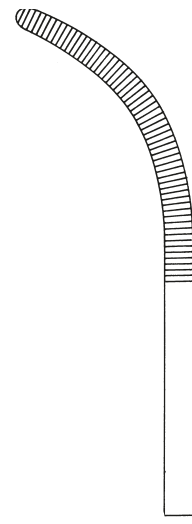
**Fig. 1**  
13-461-01-07  
24 cm / 9 4/8"



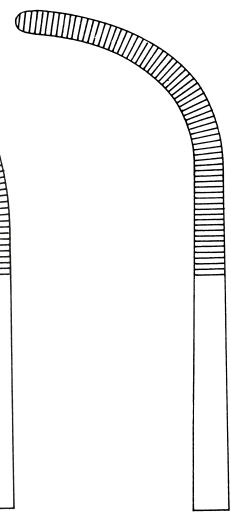
**Fig. 2**  
13-461-02-07  
24 cm / 9 4/8"



**Fig. 3**  
13-461-03-07  
23,5 cm / 9 2/8"



**Fig. 4**  
13-461-04-07  
24 cm / 9 4/8"



**Fig. 5**  
13-461-05-07  
24 cm / 9 4/8"

Rumel  
13-461-01-07 -  
13-461-05-07

## Präparierklemmen

Dissecting and Ligature Forceps

Pinzas para preparación y ligadura

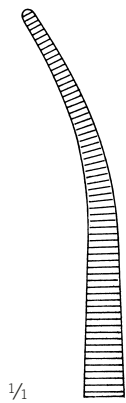
Pinces à disséquer et à ligatures

Pinze per preparazioni e legature



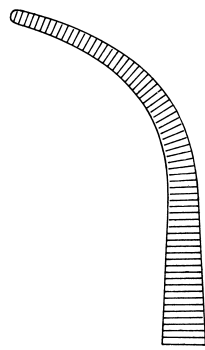
1/2

Zenker  
13-469-01-07 -  
13-469-02-07



1/1

13-469-01-07  
29,5 cm / 11 5/8"



13-469-02-07  
28,5 cm / 11 2/8"



1/2

Mixer-Baby  
13-471-14-07  
13 cm / 5 1/8"



1/1

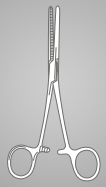


## Präparierklemmen

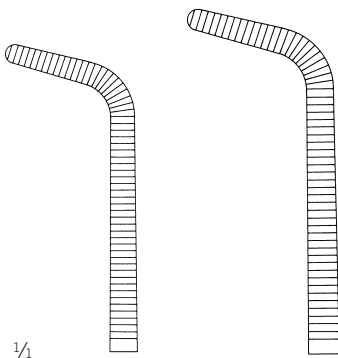
Dissecting and Ligature Forceps  
 Pinzas para preparación y ligadura  
 Pincès à disséquer et à ligatures  
 Pinze per preparazioni e legature

## Arterienklemmen

Haemostatic Forceps  
 Pinzas hemostáticas  
 Pincès hémostatiques  
 Pinze emostatiche



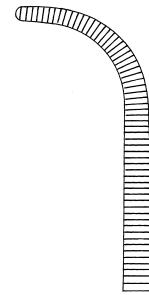
13



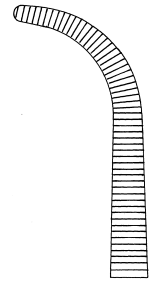
1/4

13-473-15-07  
 16 cm / 6 2/8"

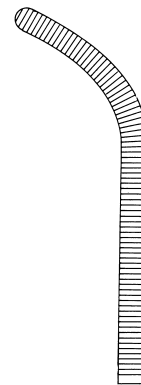
13-473-19-07  
 17,5 cm / 6 7/8"



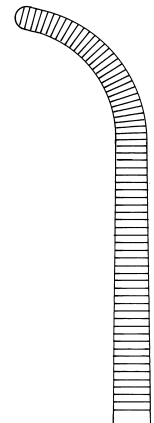
13-479-14-07  
 15 cm / 5 7/8"



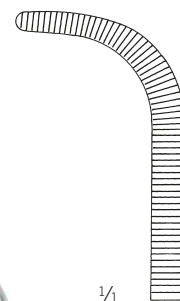
13-479-17-07  
 18 cm / 7 1/8"



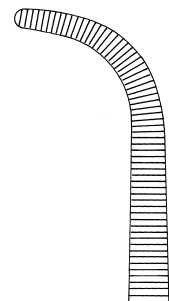
13-479-19-07  
 18,5 cm / 7 2/8"



13-479-20-07  
 20 cm / 7 7/8"



1/4  
 13-479-23-07  
 23 cm / 9"



13-479-26-07  
 26 cm / 10 2/8"



1/2

Mixer  
 13-473-15-07 -  
 13-473-19-07



1/2

O'Shaughnessy  
 13-479-14-07 -  
 13-479-26-07

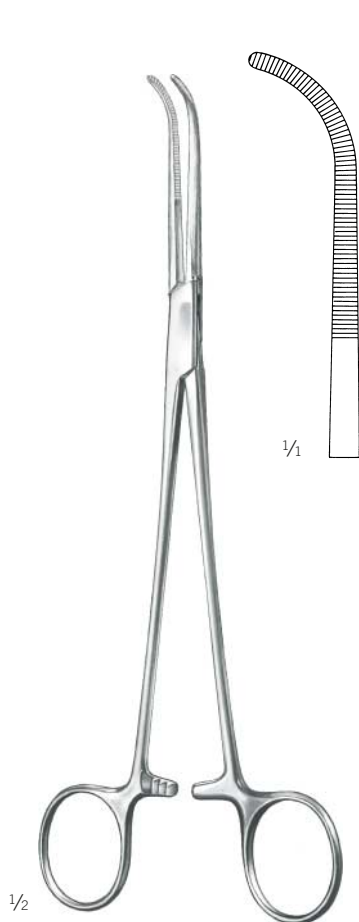
## Präparierklemmen

Dissecting and Ligature Forceps

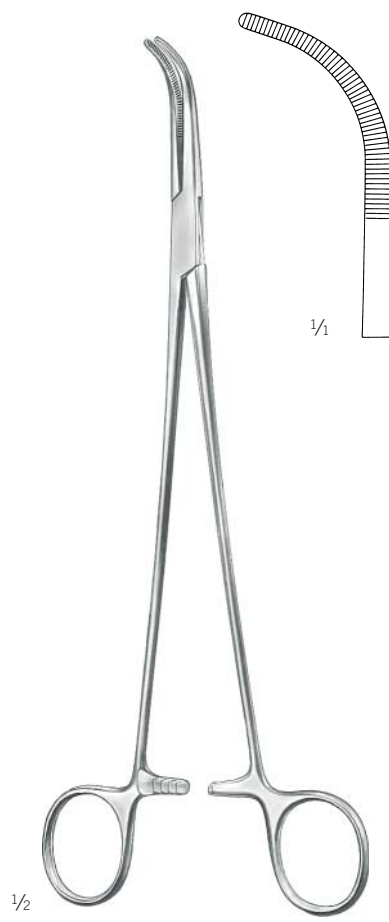
Pinzas para preparación y ligadura

Pinces à disséquer et à ligatures

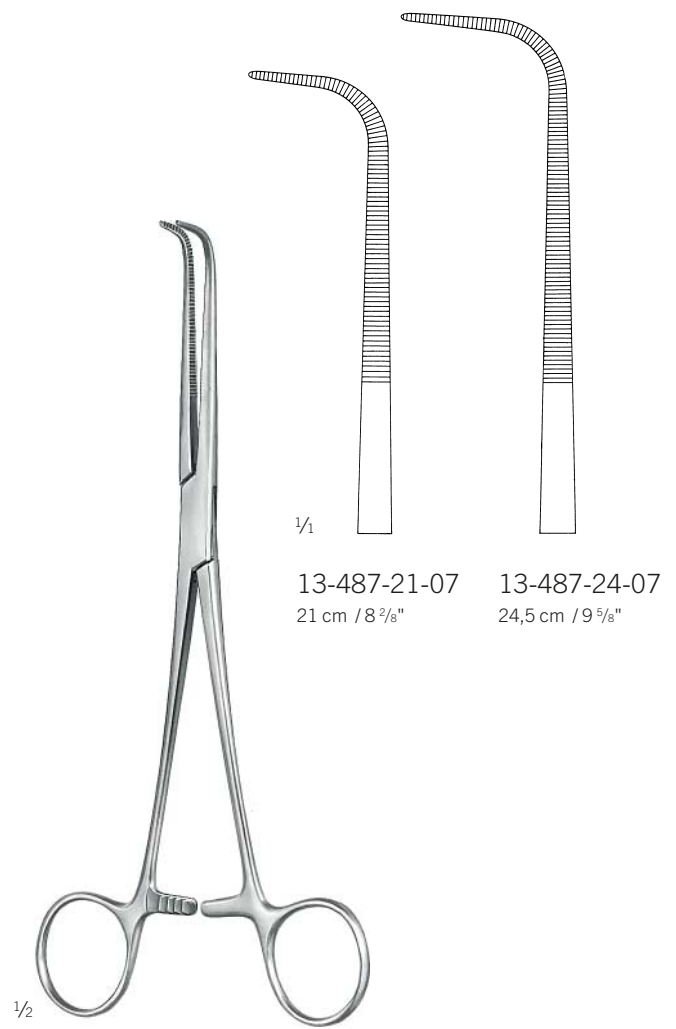
Pinze per preparazioni e legature



Mixer  
13-483-22-07  
22,5 cm / 8 7/8"



Mixer  
13-485-23-07  
23 cm / 9"



13-487-21-07  
21 cm / 8 2/8"

13-487-24-07  
24,5 cm / 9 5/8"

## Präparierklemmen

Dissecting and Ligature Forceps  
Pinzas para preparación y ligadura  
Pincès à disséquer et à ligatures  
Pinze per preparazioni e legature

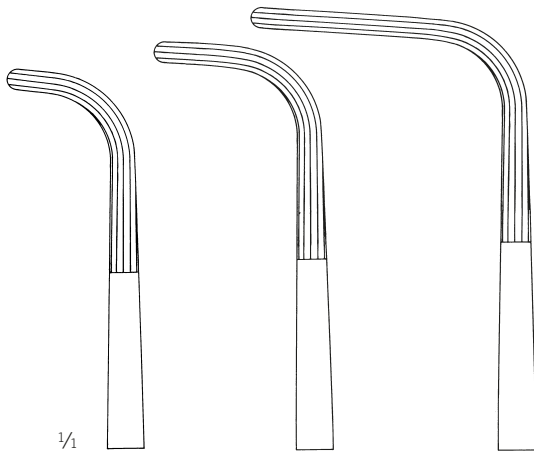
## Arterienklemmen

Haemostatic Forceps  
Pinzas hemostáticas  
Pincès hémostatiques  
Pinze emostatiche



1/2

Mixer  
13-491-22-07 -  
13-495-28-07

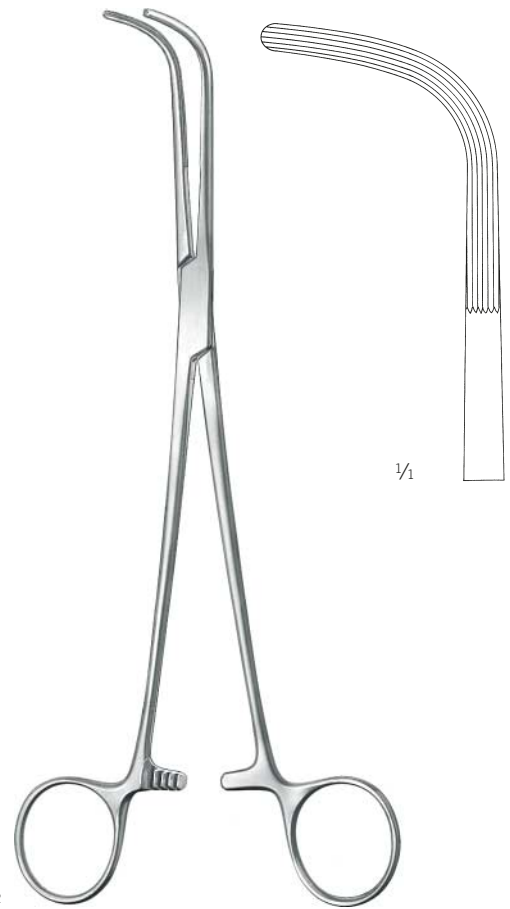


1/1

13-491-22-07  
22,5 cm / 8 7/8"

13-493-25-07  
26 cm / 10 2/8"

13-495-28-07  
28 cm / 11"



1/2

McQuigg-Mixer  
13-497-22-07  
23,5 cm / 9 2/8"

1/1

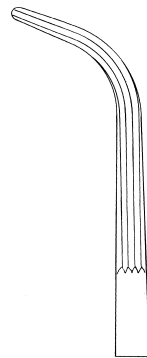
## Gallenkanalklemmen, Präparierklemmen

Bile Duct Clamps, Dissecting and Ligature Forceps

Pinzas para conducto biliar, Pinzas para preparación y ligadura

Pinces pour les voies biliaires, Pinces à disséquer et à ligatures

Pinze per vie biliari, Pinze per preparazioni e legature



13-511-19-07  
19,5 cm / 7 <sup>5</sup>/<sub>8</sub>"

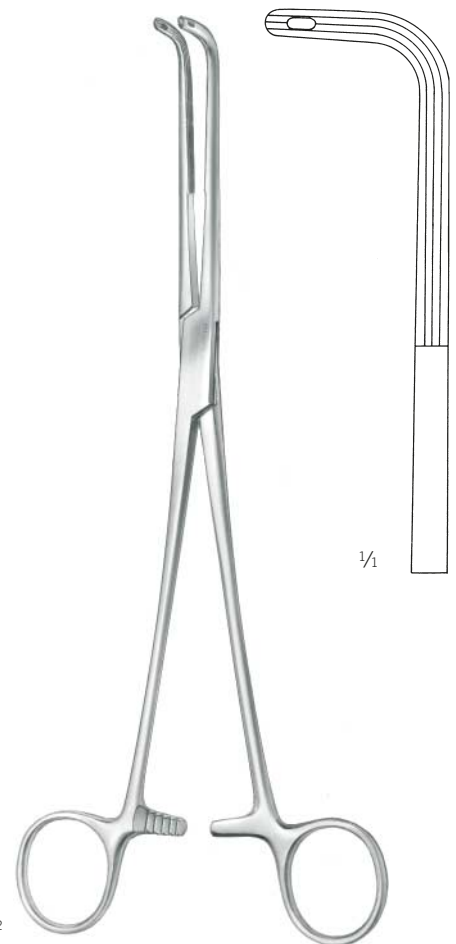


Lower  
13-501-18-07  
18,5 cm / 7 <sup>1</sup>/<sub>4</sub>"



Lahey  
13-511-19-07 -  
13-513-23-07

13-513-23-07  
22,5 cm / 8 <sup>7</sup>/<sub>8</sub>"



Finochietto  
13-521-24-07  
24,5 cm / 9 <sup>5</sup>/<sub>8</sub>"

## Tangentialklemmen, Nierenstielklemmen

Tangential Forceps, Kidney Pedicle Clamps

Pinzas tangenciales, Pinzas para pedículo renal

Pinces tangentielles, Pince-clamps pour pédicules rénaux

Pinze tangenziali, Pinze per peduncoli renali

## Arterienklemmen

Haemostatic Forceps

Pinzas hemostáticas

Pinces hémostatiques

Pinze emostatiche



## Atrauma

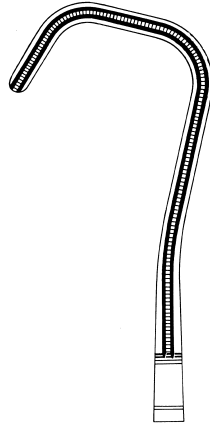
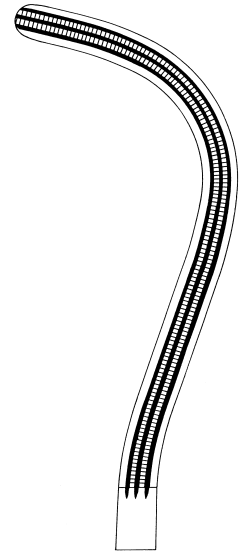


Fig. 1  
13-527-01-07  
25 cm / 9 7/8"



13-529-23-07  
23 cm / 9"

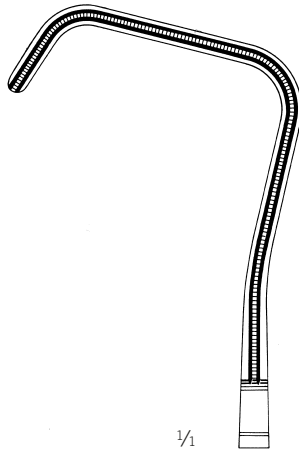
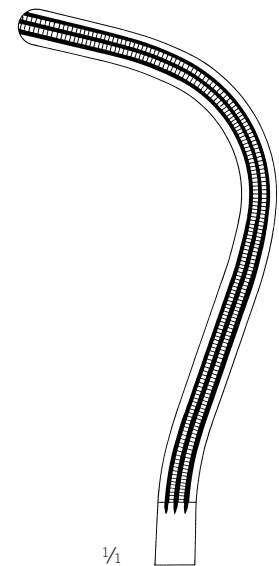


Fig. 2  
13-527-02-07  
26 cm / 10 2/8"



13-529-24-07  
24 cm / 9 4/8"



1/2

Uro-Tangential  
13-527-01-07 -  
13-527-02-07



1/2

Guyon  
13-529-23-07 -  
13-529-24-07

## Nierenstielklemmen

Kidney Pedicle Clamps

Pinzas para pedículo renal

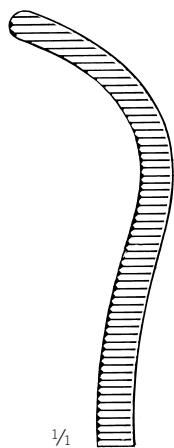
Pince-clamps pour pédicules rénaux

Pinze per peduncoli renali



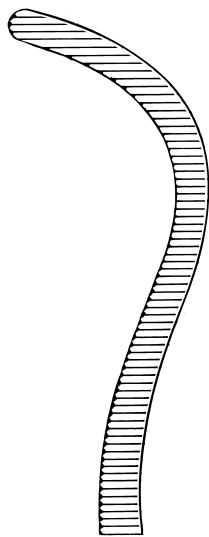
1/2

Guyon  
13-531-20-07 -  
13-531-24-07

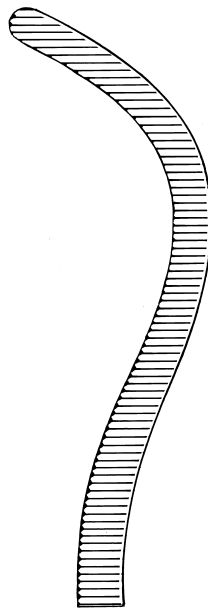


1/1

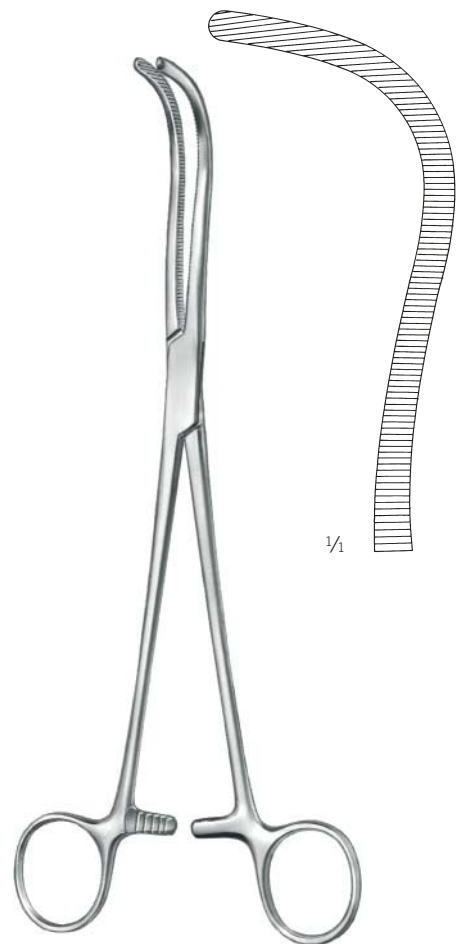
13-531-20-07  
19,5 cm / 7 5/8"



13-531-22-07  
21,5 cm / 8 4/8"



13-531-24-07  
24,5 cm / 9 5/8"



1/2

Guyon  
13-533-23-07  
24 cm / 9 4/8"

1/1

## Gallenkanalklemmen

Bile Duct Clamps  
Pinzas para conducto biliar  
Pincas pour les voies biliaires  
Pinze per vie biliari

## Arterienklemmen

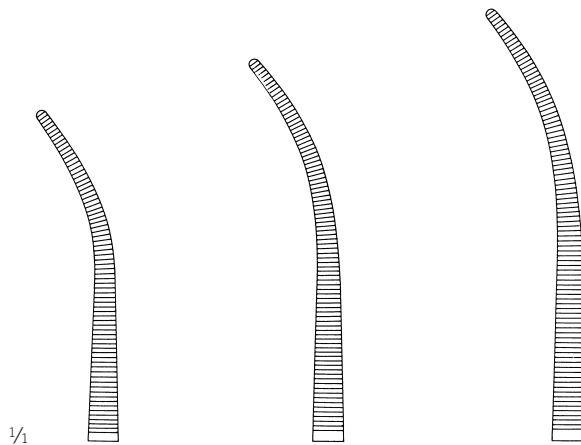
Haemostatic Forceps  
Pinzas hemostáticas  
Pincas hémostatiques  
Pinze emostatiche



Desjardins  
13-571-21-07  
21 cm / 8 2/8"

## Präparierklemmen

Dissecting and Ligature Forceps  
 Pinzas para preparación y ligadura  
 Pinces à disséquer et à ligatures  
 Pinze per preparazioni e legature

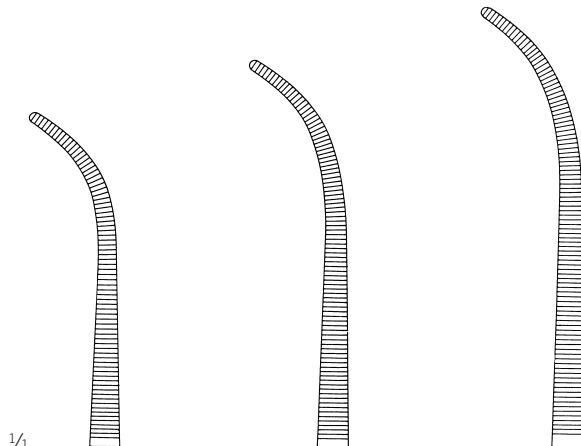


1/1

**Fig. 1**  
 13-577-19-07  
 19 cm / 7 7/8"

**Fig. 1**  
 13-577-22-07  
 22,5 cm / 8 7/8"

**Fig. 1**  
 13-577-24-07  
 23 cm / 9"

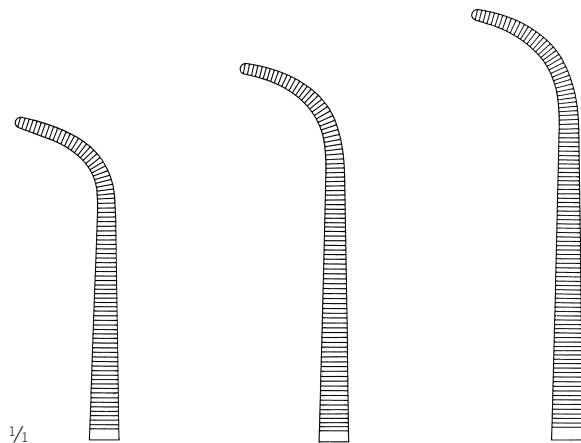


1/1

**Fig. 2**  
 13-579-19-07  
 19 cm / 7 7/8"

**Fig. 2**  
 13-579-22-07  
 22 cm / 8 5/8"

**Fig. 2**  
 13-579-24-07  
 23,5 cm / 9 1/8"



1/1

**Fig. 3**  
 13-581-19-07  
 18,5 cm / 7 3/8"

**Fig. 3**  
 13-581-22-07  
 21,5 cm / 8 4/8"

**Fig. 3**  
 13-581-24-07  
 23 cm / 9"



1/2

**Kelly**  
 13-577-19-07 -  
 13-581-24-07



## Präparierklemmen, Arterienklemmen

Dissecting and Ligature Forceps, Haemostatic Forceps  
Pinzas para preparación y ligadura, Pinzas hemostáticas  
Pincas à disséquer et à ligatures, Pincas hémostatiques  
Pinze per preparazioni e legature, Pinze emostatiche

## Arterienklemmen

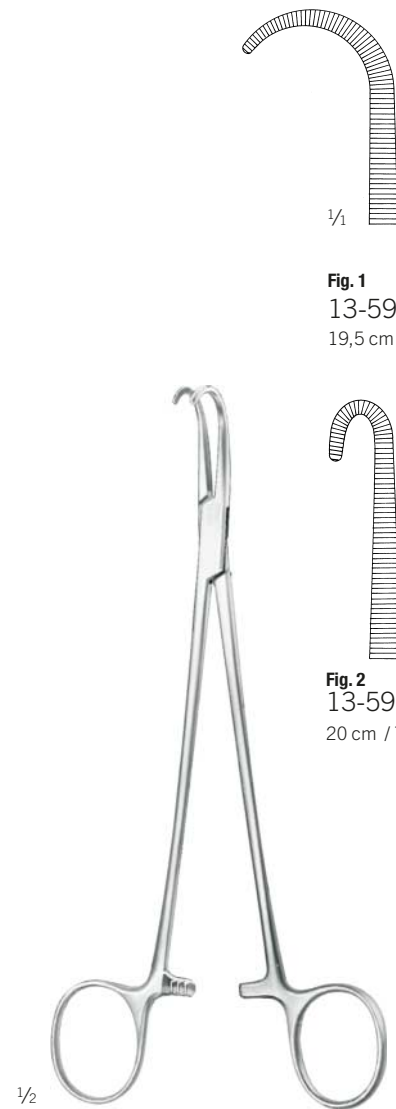
Haemostatic Forceps  
Pinzas hemostáticas  
Pincas hémostatiques  
Pinze emostatiche



Lawrence  
13-583-28-07  
28 cm / 11"



Meeker  
13-585-28-07  
28 cm / 11"



Negus  
13-595-19-07 -  
13-597-19-07

**Fig. 1**  
13-595-19-07  
19,5 cm / 7 5/8"

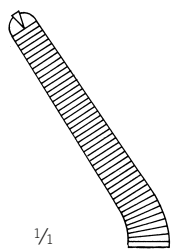
**Fig. 2**  
13-597-19-07  
20 cm / 7 7/8"

# Hysterektomieklemmen

Hysterectomy Forceps  
 Pinzas para histerectomía  
 Pinces à hystérectomie  
 Pinze per isterectomia

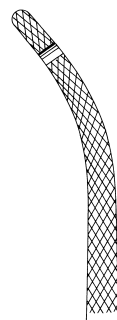


13-600-21-07  
 20,5 cm / 8 1/8"

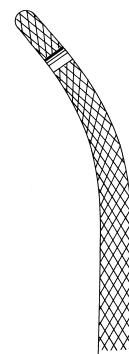


1/4

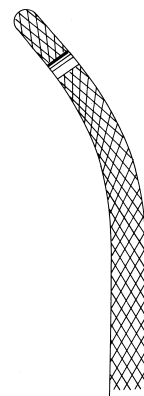
13-601-21-07  
 20 cm / 7 7/8"



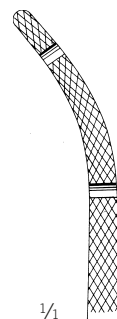
**Fig. 1**  
 13-613-19-07  
 19,5 cm / 7 5/8"



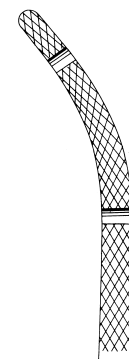
**Fig. 1**  
 13-613-21-07  
 21,5 cm / 8 4/8"



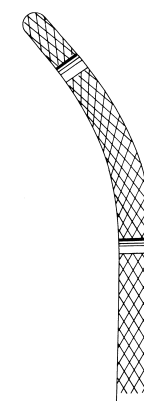
**Fig. 1**  
 13-613-23-07  
 24 cm / 9 4/8"



**Fig. 2**  
 13-615-19-07  
 19,5 cm / 7 5/8"



**Fig. 2**  
 13-615-21-07  
 21,5 cm / 8 4/8"



**Fig. 2**  
 13-615-23-07  
 24 cm / 9 4/8"



1/2

Phaneuf  
 13-600-21-07 -  
 13-601-21-07



1/2

Heaney  
 13-613-19-07 -  
 13-615-23-07

## Vaginalklemmen

Vaginal Clamp  
Pinzas vaginal  
Pincas vaginales  
Pinza vaginale

## Arterienklemmen

Haemostatic Forceps  
Pinzas hemostáticas  
Pincas hémostatiques  
Pinze emostatiche



$\frac{1}{2}$

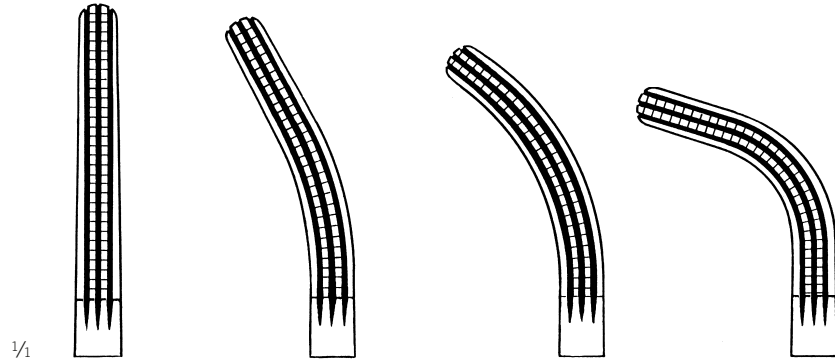
Wertheim-Cullen  
13-625-21-07  
21 cm / 8  $\frac{2}{8}$ "

$\frac{1}{1}$

# Hysterektomieklemmen

Hysterectomy Forceps  
Pinzas para histerectomía  
Pincers à hystérectomie  
Pinze per isterectomia

Atrauma

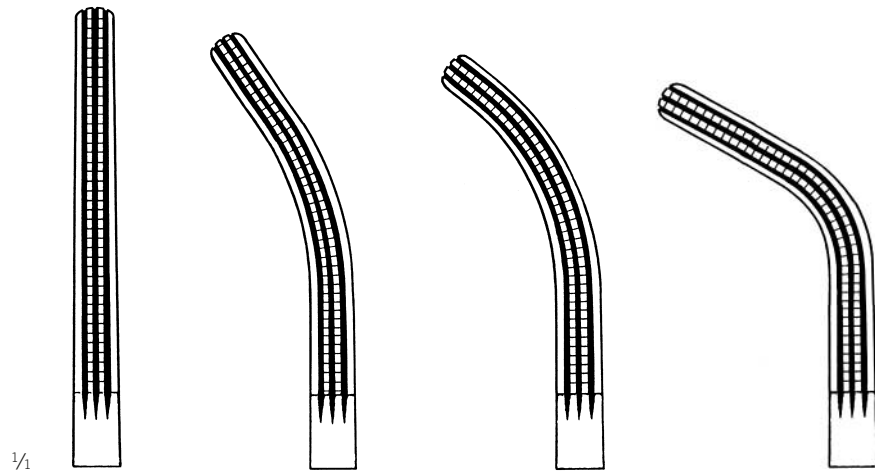


**Fig. 1**  
13-635-10-07  
21,5 cm / 8 4/8"

**Fig. 2**  
13-635-20-07  
21 cm / 8 2/8"

**Fig. 3**  
13-635-30-07  
21 cm / 8 2/8"

**Fig. 4**  
13-635-40-07  
20,5 cm / 8 1/8"



**Fig. 1**  
13-637-10-07  
25,5 cm / 10"

**Fig. 2**  
13-637-20-07  
25 cm / 9 7/8"

**Fig. 3**  
13-637-30-07  
24,5 cm / 9 4/8"

**Fig. 4**  
13-637-35-07  
24,5 cm / 9 4/8"



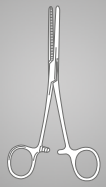
Rogers  
13-635-10-07 -  
13-637-35-07

## Gallenkanalklemmen

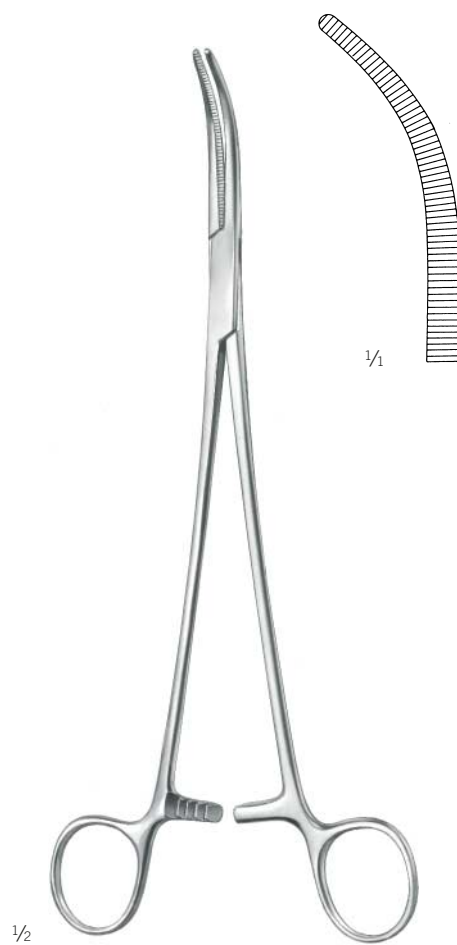
Bile Duct Clamps  
Pinzas para conducto biliar  
Pincas pour les voies biliaires  
Pinze per vie biliari

## Arterienklemmen

Haemostatic Forceps  
Pinzas hemostáticas  
Pincas hémostatiques  
Pinze emostatiche



Moynihan  
13-671-23-07  
23 cm / 9"



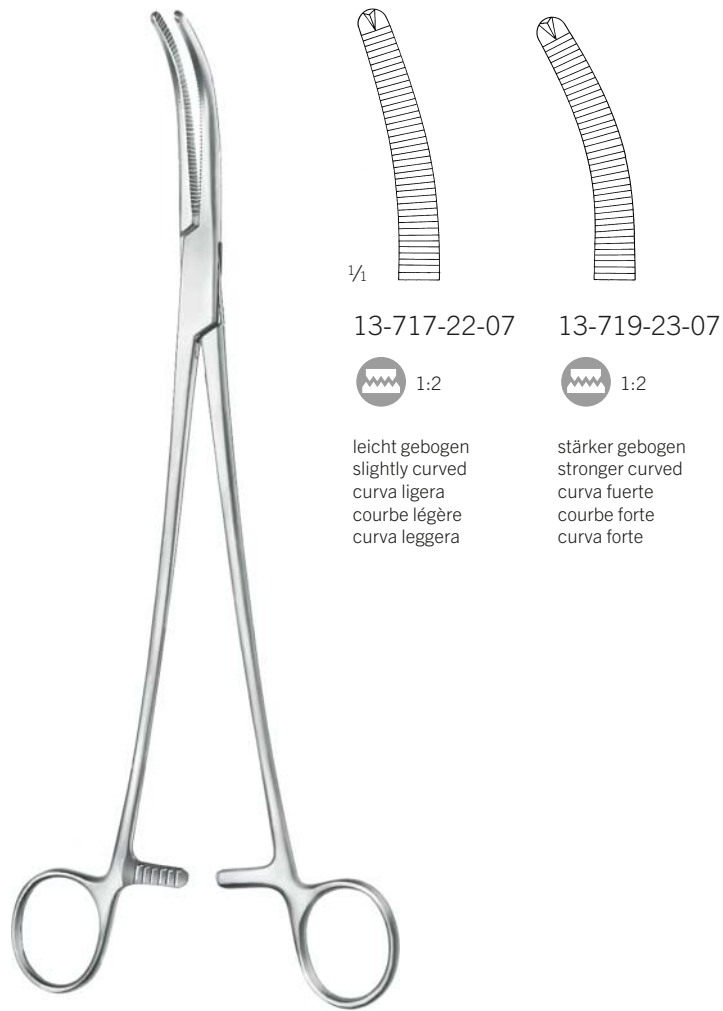
Moynihan  
13-673-24-07  
23,5 cm / 9 2/8"

## Hysterektomieklemmen

Hysterectomy Forceps  
Pinzas para histerectomía  
Pincès à hystérectomie  
Pinze per isterectomia



Wertheim  
13-697-25-07  
26 cm / 10 2/8"



leicht gebogen  
slightly curved  
curva ligera  
courbe légère  
curva leggera

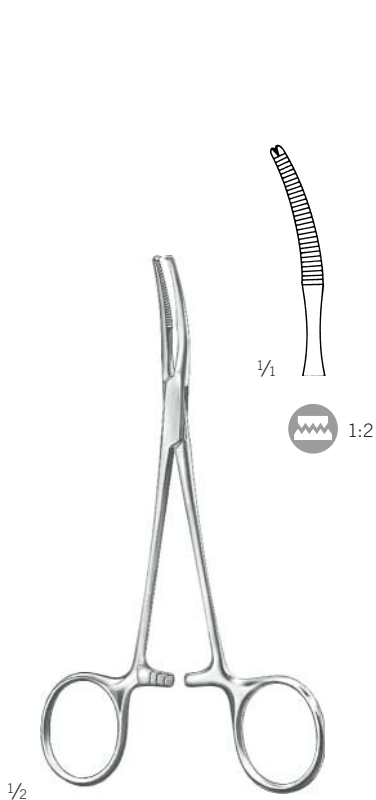
stärker gebogen  
stronger curved  
curva fuerte  
courbe forte  
curva forte

## Peritoneumklemmen

Peritoneum Forceps  
Pinzas para peritoneo  
Pince pour le péritoine  
Pinze per peritoneo

## Arterienklemmen

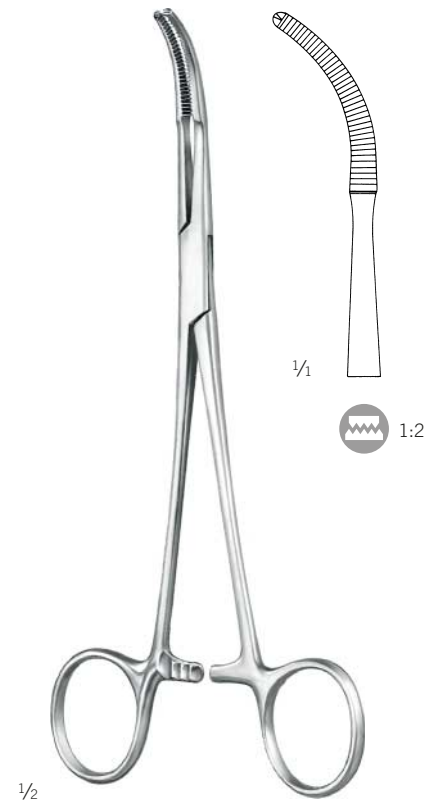
Haemostatic Forceps  
Pinzas hemostáticas  
Pincas hémostatiques  
Pinze emostatiche



Mikulicz-Baby  
13-721-14-07  
14,5 cm / 5 9/16"



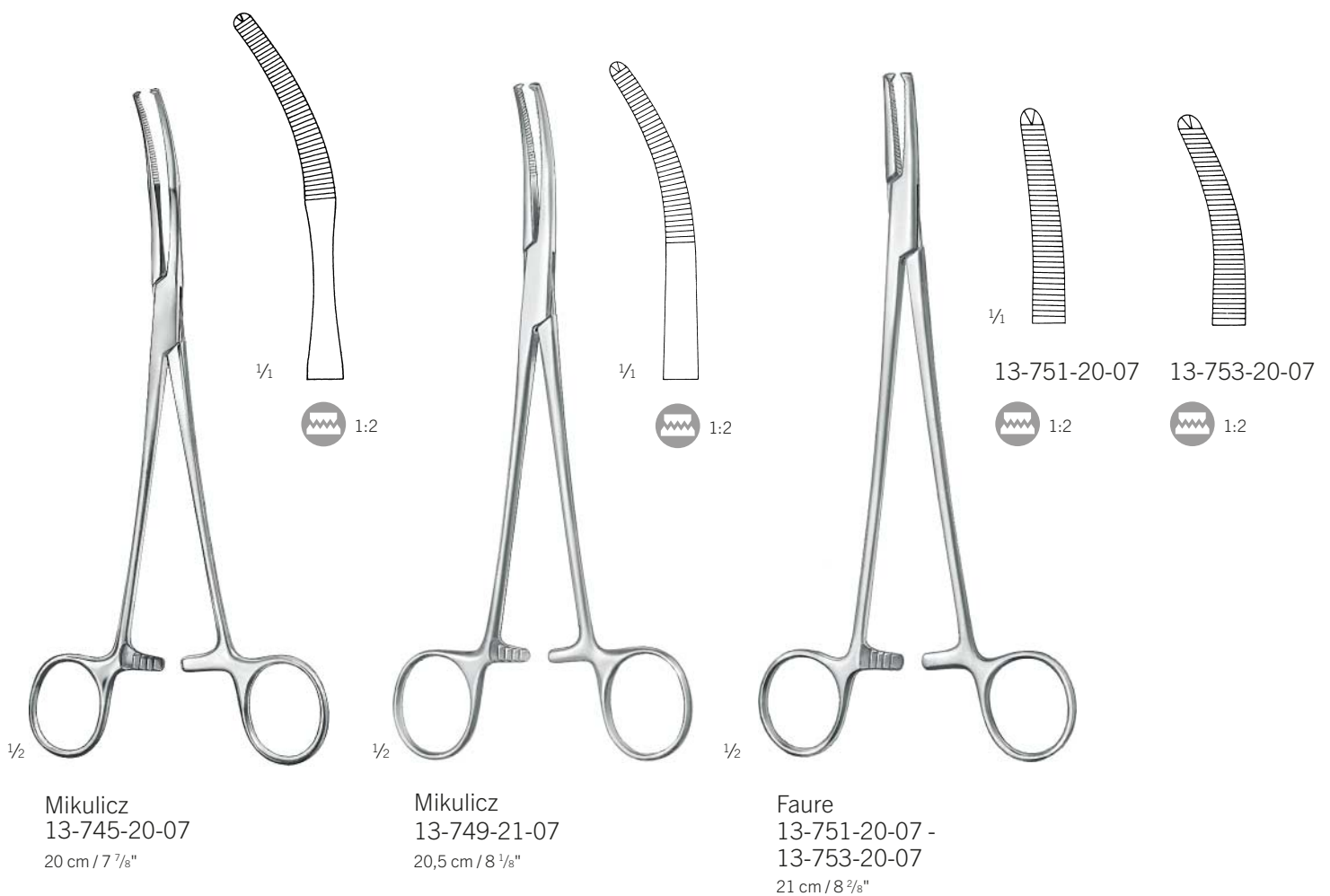
Mikulicz  
13-725-18-07  
18,5 cm / 7 3/8"



Mikulicz  
13-727-20-07  
20 cm / 7 7/8"

## Peritoneumklemmen

Peritoneum Forceps  
Pinzas para peritoneo  
Pince pour le péritoine  
Pinze per peritoneo





## Tuchklemmen

Towel Clamps  
Pinzas de campo  
Pincas à champs  
Pinze fissatele

## Arterienklemmen

Haemostatic Forceps  
Pinzas hemostáticas  
Pincas hémostatiques  
Pinze emostatiche



1/2

Schädel  
13-875-09-07  
9 cm / 3 4/8"

scharf  
sharp  
agudo  
pointu  
acuto



1/2

13-881-05-07

5,5 cm / 2 1/8"

13-881-09-07

8,5 cm / 3 3/8"

Jones  
13-881-05-07 -  
13-881-09-07

scharf  
sharp  
agudo  
pointu  
acuto



1/2

13-909-11-07  
11 cm / 4 3/8"

13-909-13-07  
13 cm / 5 1/8"

Backhaus  
13-909-11-07 -  
13-909-13-07

graziles Modell, scharf  
delicate model, sharp  
modelo delicado, aguda  
modèle gracile, aiguë  
modello delicato, acuto



1/2

Backhaus  
13-913-11-07  
11 cm / 4 3/8"

scharf, mit Schlauchhalter  
sharp, with tube holder  
agudo, con porta-tubo  
pointu, avec clamp porte-tube  
acuto, con porta-tubo



1/2

Backhaus  
13-915-08-07 -  
13-915-15-07

scharf  
sharp  
agudo  
pointu  
acuto



1/1

13-915-08-07  
9 cm / 3 4/8"

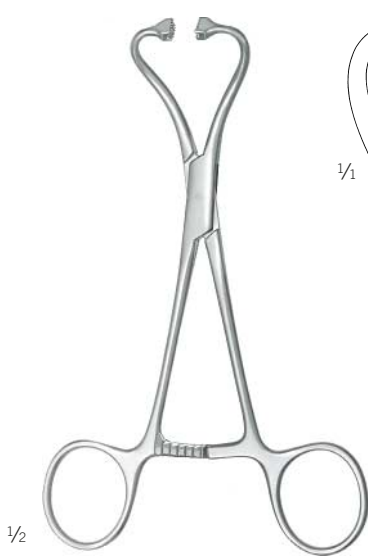
13-915-11-07  
11 cm / 4 3/8"

13-915-13-07  
13 cm / 5 1/8"

13-915-15-07  
16 cm / 6 2/8"

## Tuchklemmen

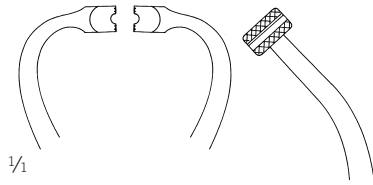
Towel Clamps  
Pinzas de campo  
Pincas à champs  
Pinze fissatele



Peers-Bertram modif.  
13-916-15-07

14,5 cm / 5 7/8"

weites Maul zur Schlauchfixierung  
wide jaw for tube fixation  
boca ancha para fijación de tubos  
mors large pour fixation de tube  
morso spalancato per fissare il tubo



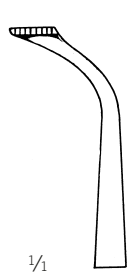
Roeder  
13-917-13-07

13,5 cm / 5 3/8"



Lorna  
13-919-10-07 -  
13-919-13-07

fein gezahnt, breites Maul  
fine serration, wide jaw  
delicadamente dentada, boca ancha  
avec dents fins, mors large  
con denti fini, morso largo



13-919-10-07  
10 cm / 3 7/8"

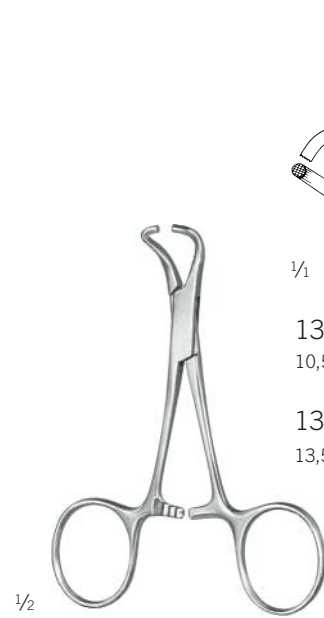
13-919-13-07  
13 cm / 5 1/8"



Bernhard  
13-921-16-07

16,5 cm / 6 4/8"

scharf  
sharp  
agudo  
pointu  
acuto



Tohoku  
13-923-10-07 -  
13-923-13-07

stumpf  
blunt  
romo  
mousse



13-923-10-07  
10,5 cm / 4 1/8"

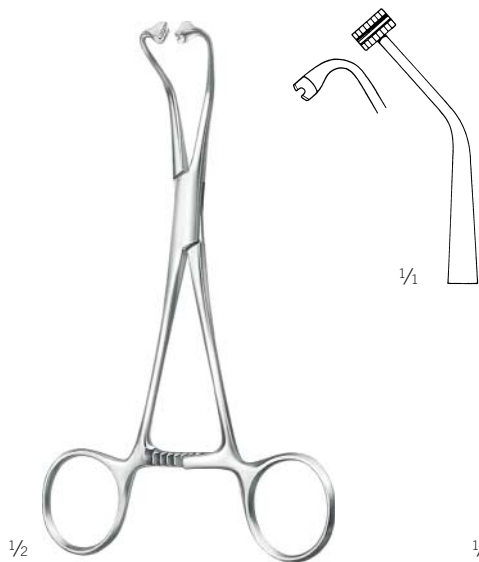
13-923-13-07  
13,5 cm / 5 3/8"

## Tuchklemmen, Schlauchklemmen

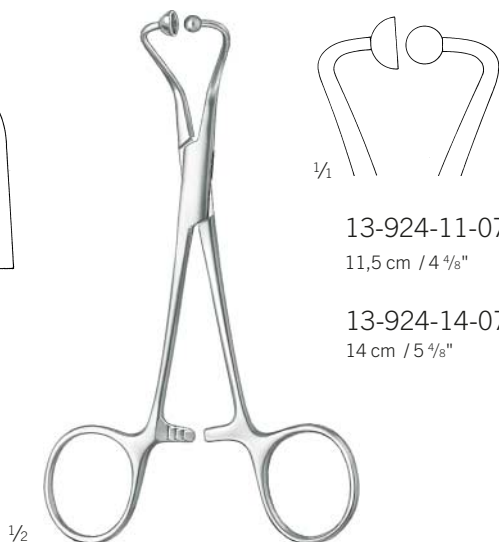
Towel Clamps, Tubing Clamps  
 Pinzas de campo, Pinzas para tubos  
 Pincas à champs, Pincas presse-tubes  
 Pinze fissatele, Pinze serratubi

## Arterienklemmen

Haemostatic Forceps  
 Pinzas hemostáticas  
 Pincas hémostatiques  
 Pinze emostatiche



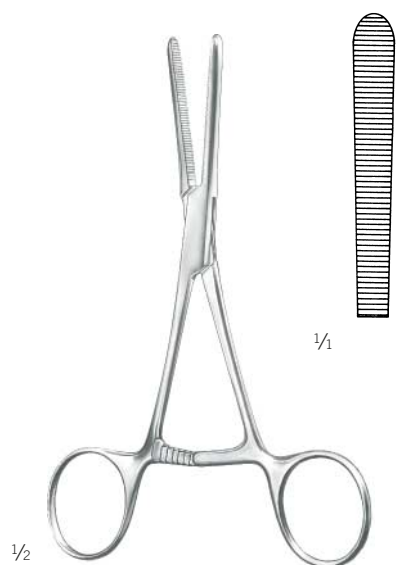
Peers-Bertram  
 13-923-14-07  
 14,5 cm / 5 7/8"



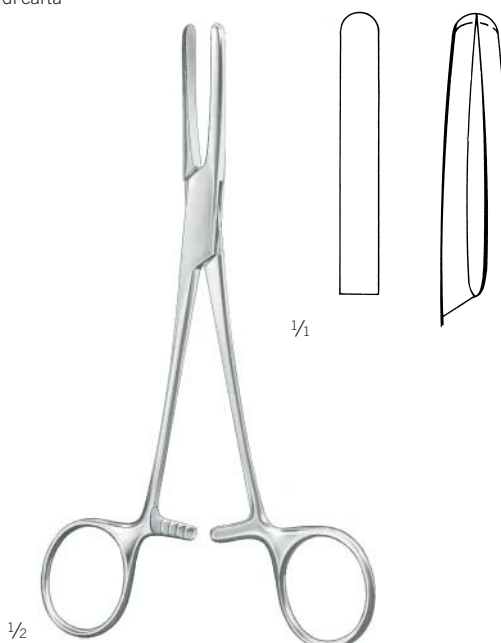
13-924-11-07 -  
 13-924-14-07  
 für Papierabdeckung  
 for paper drapes  
 para paños de papel  
 pour couverture en papier  
 per copertura di carta



Lane  
 13-935-20-07  
 19,5 cm / 7 5/8"



13-940-14-07  
 14 cm / 5 4/8"  
 extra lange Sperre  
 extra long ratchet  
 cremallera extra larga  
 cremaillère extrêmement longue  
 cremagliera stralunga



13-942-16-07  
 16,5 cm / 6 4/8"  
 glattes Maul  
 smooth jaw  
 boca lisa  
 mors lisse  
 morso liscio

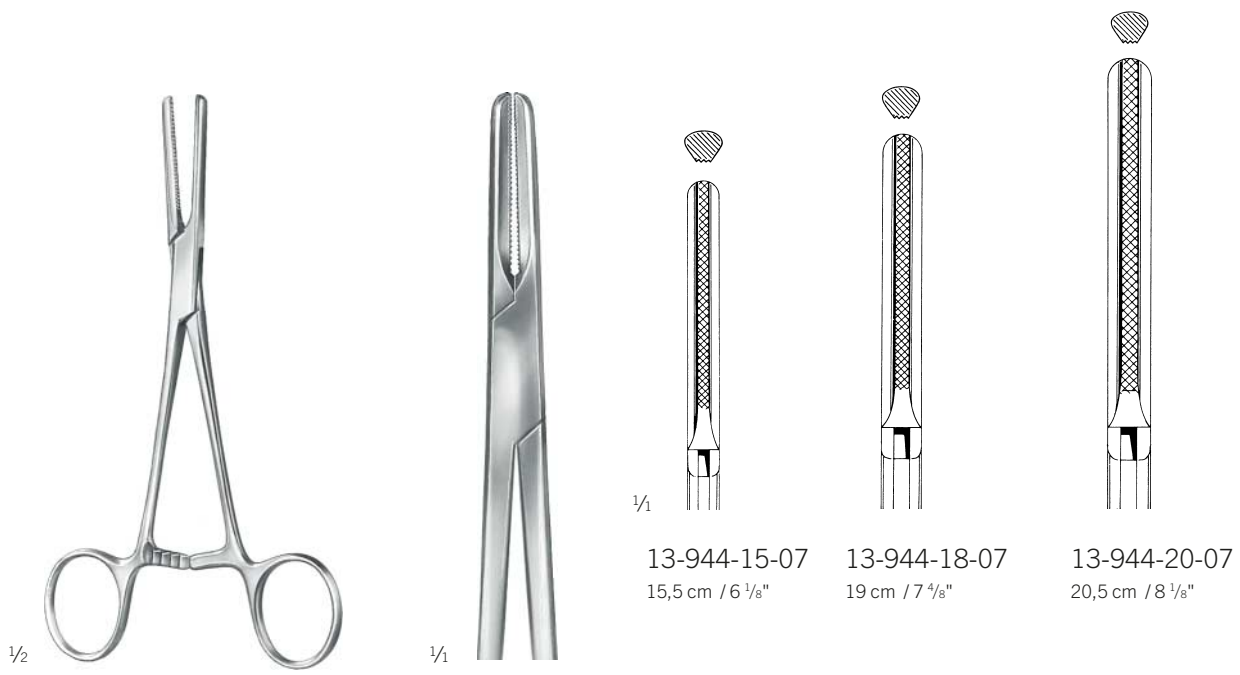
# Schlauchklemmen

Tubing Clamps

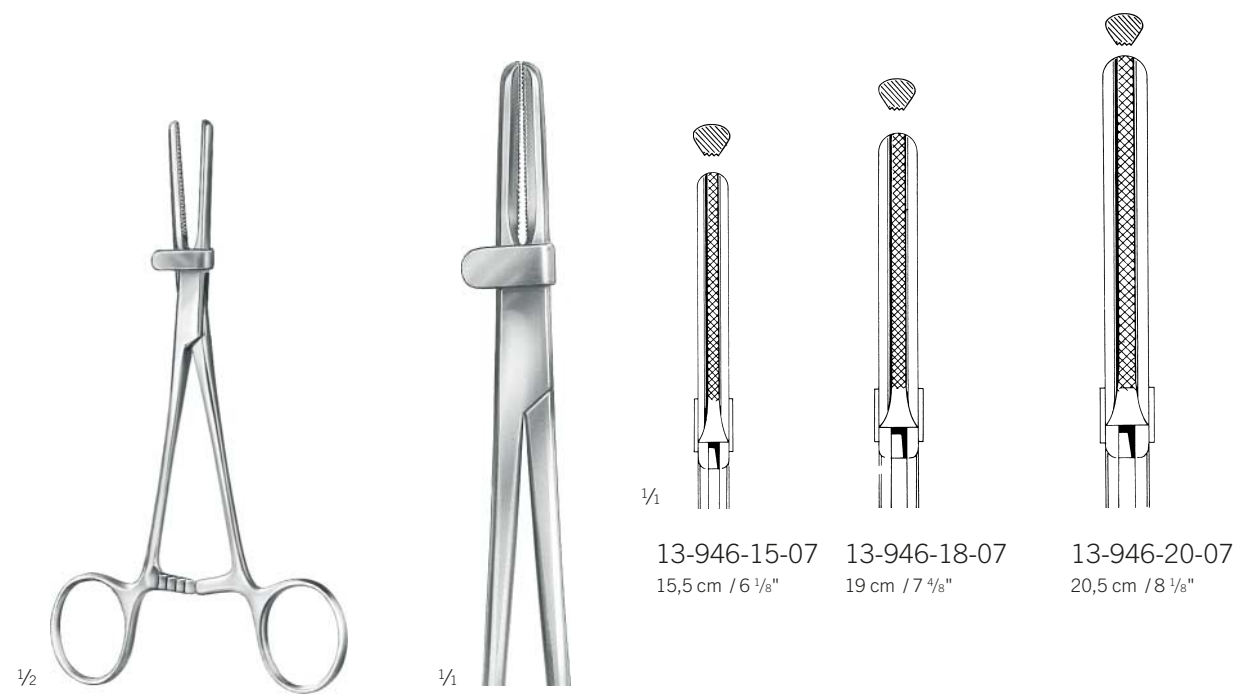
Pinzas para tubos

Pinces presse-tubes

Pinze serratubi



13-944-15-07 -  
13-944-20-07



13-946-15-07 -  
13-946-20-07

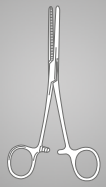
mit Schutzbügel  
with safety guard  
con stribo de protección  
avec protection  
con protezione

## Schlauchklemmen

Tubing Clamps  
Pinzas para tubos  
Pincas presse-tubes  
Pinze serratubi

## Arterienklemmen

Haemostatic Forceps  
Pinzas hemostáticas  
Pincas hémostatiques  
Pinze emostatiche



1/2

Brompton  
13-948-01-04  
16,5 cm / 6 1/8"

AI



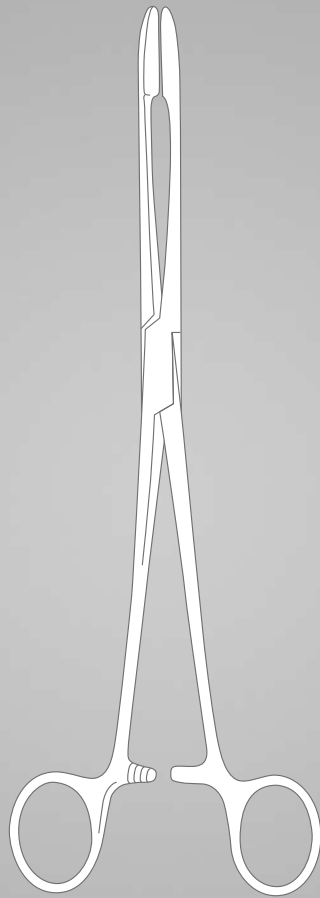
1/2

Gunnar-Hey  
13-948-02-07  
18 cm / 7 1/8"



# 14

Tupfer- und Kornzangen  
Cotton Swap Forceps  
Pinzas para tampones y curaciones  
Pinces à tampons et à pansements  
Pinze per tamponi e per medicazione



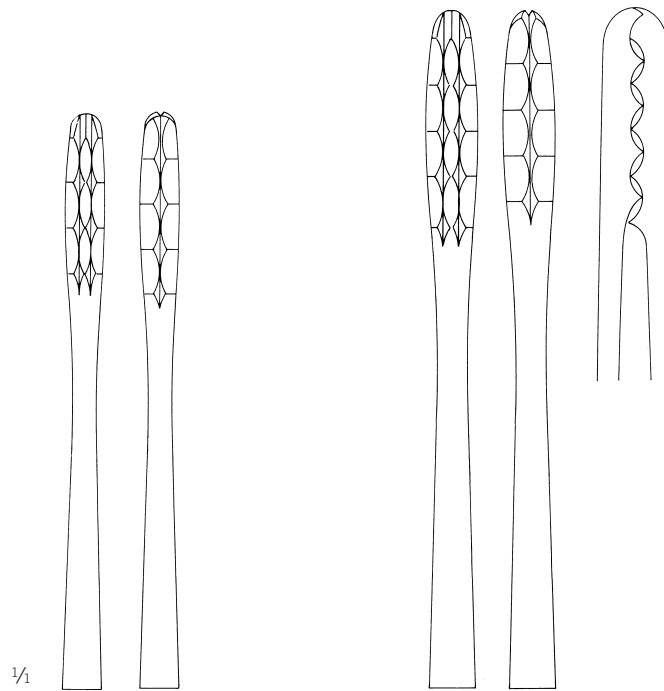
## Tupferzangen

Dressing Forceps

Pinzas para tapones

Pinces à tampons

Pinze per tamponi



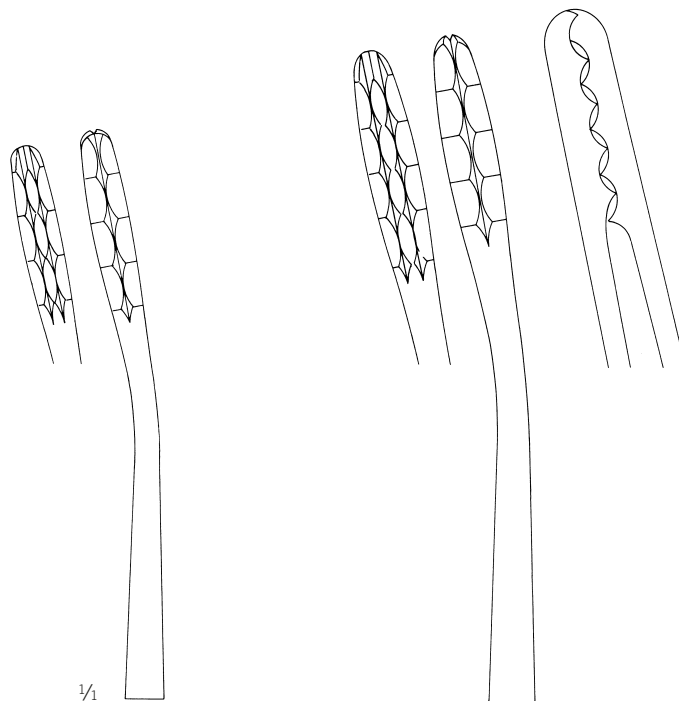
14-100-22-07  
22,5 cm / 8<sup>7</sup>/<sub>8</sub>"

14-100-27-07  
27 cm / 10<sup>5</sup>/<sub>8</sub>"



1/2

Ulrich  
14-100-22-07 -  
14-101-27-07



14-101-22-07  
22,5 cm / 8<sup>7</sup>/<sub>8</sub>"

14-101-27-07  
26,5 cm / 10<sup>7</sup>/<sub>8</sub>"



## Sinusklemmen, Kornzangen

Sinus Forceps, Dressing Forceps  
Pinzas para vendajes, Pinzas para vendajes  
Pinces Sinus, Pinces à pansements  
Pinze per seni, Pinze per medicature

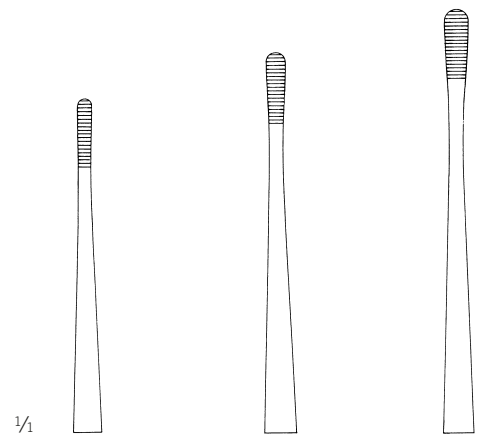
## Tupfer- und Kornzangen

Cotton Swap Forceps  
Pinzas para tampones y curaciones  
Pinces à tampons et à pansements  
Pinze per tamponi e per medicazione



1/2

Lister  
14-110-13-07 -  
14-110-18-07

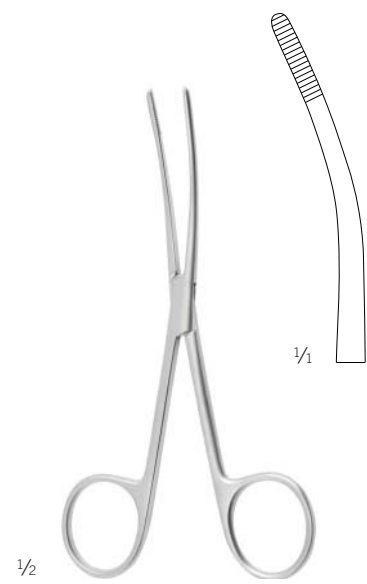


1/1

14-110-13-07  
13 cm / 5 1/8"

14-110-16-07  
16 cm / 6 2/8"

14-110-18-07  
18,5 cm / 7 2/8"



1/2

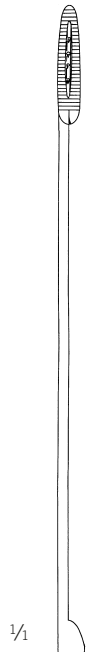
Bryant  
14-115-13-07  
13 cm / 5 1/8"

1/1



1/2

Martin  
14-120-17-07  
17,5 cm / 6 7/8"



1/1

## Kornzangen

Dressing Forceps

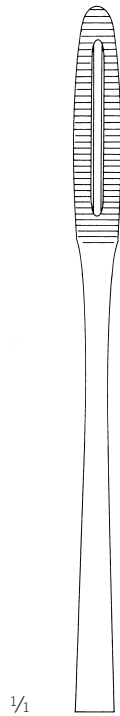
Pinzas para vendajes

Pinces à pansements

Pinze per medicature



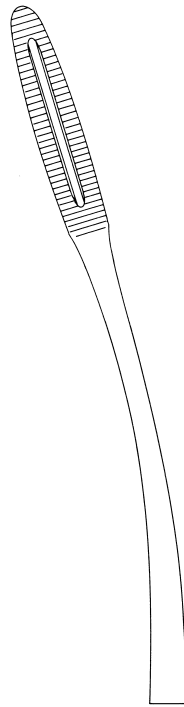
Gross-Maier  
14-222-20-07 -  
14-223-27-07



14-222-20-07  
20,5 cm / 8 1/8"

14-222-22-07  
22,5 cm / 8 7/8"

14-222-27-07  
26,5 cm / 10 3/8"



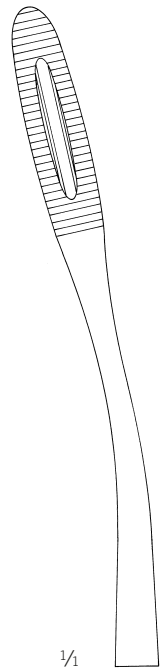
14-223-20-07  
20,5 cm / 8 1/8"

14-223-22-07  
22,5 cm / 8 7/8"

14-223-27-07  
26,5 cm / 10 3/8"



14-231-40-07  
39,5 cm / 15 4/8"  
Tunnelier-Kornzange  
Tunneling Forceps  
Pinza para tunelar  
Pince pour tunnelisation  
Pinza per tunnelare



## Kornzangen

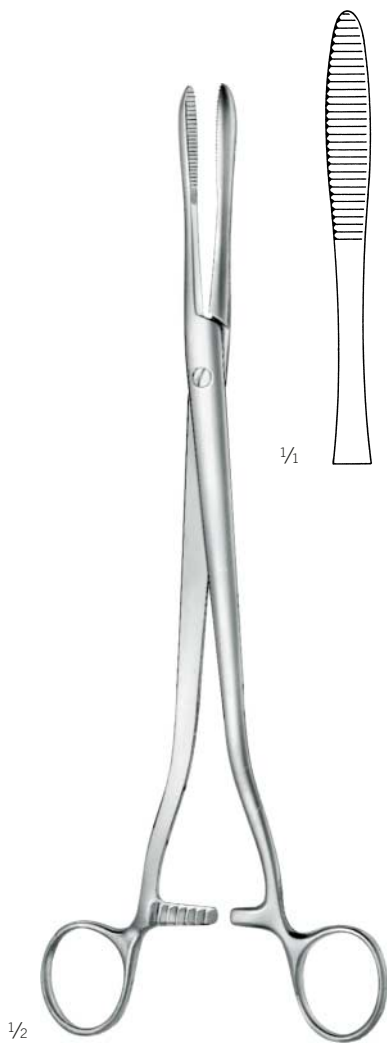
Dressing Forceps  
Pinzas para vendajes  
Pincas à pansements  
Pinze per medicature

## Tupfer- und Kornzangen

Cotton Swap Forceps  
Pinzas para tampones y curaciones  
Pincas à tampons et à pansements  
Pinze per tamponi e per medicazione



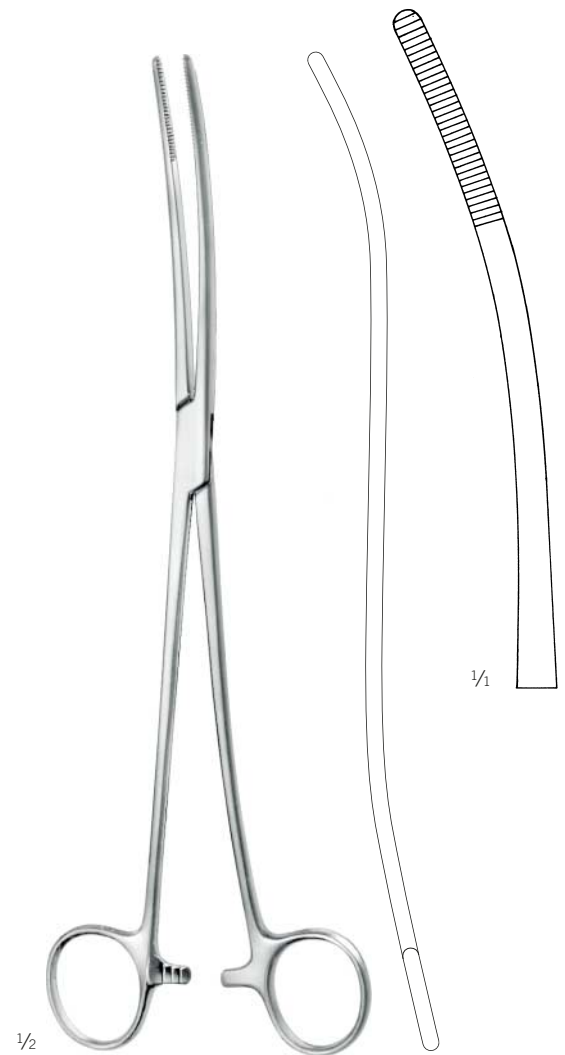
14



Collin  
14-286-25-07  
25 cm / 9 7/8"



Cheron  
14-290-25-07  
25 cm / 9 7/8"



Bozemann  
14-313-26-07  
26 cm / 10 2/8"  
S-Form  
S-shape  
forma S  
courbés en S  
curve in forma S

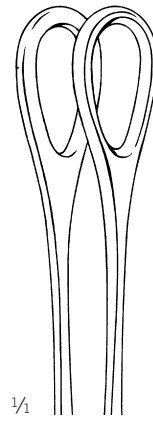
## Schwammzangen

Sponge Forceps

Pinzas para tapones

Pinces pour éponges

Pinze per tamponi e spunge

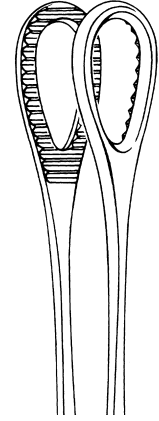


1/1

14-350-25-07

25 cm / 9 7/8"

glattes Maul  
smooth jaw  
boca lisa  
mors lisse  
morso liscio



14-352-18-07

18 cm / 7 1/8"

14-352-20-07

20,5 cm / 8 1/8"

14-352-25-07

25 cm / 9 7/8"



1/1

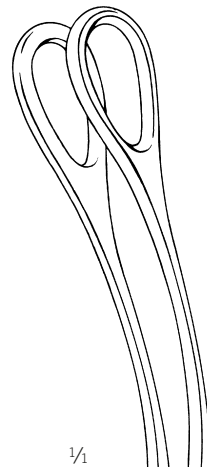
1/2

Bergmann  
14-320-24-07  
24 cm / 9 4/8"



1/2

Förster  
14-350-25-07 -  
14-355-25-07

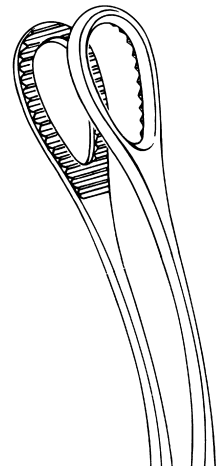


1/1

14-353-25-07

24,5 cm / 9 5/8"

glattes Maul  
smooth jaw  
boca lisa  
mors lisse  
morso liscio



14-355-18-07

18 cm / 7 1/8"

14-355-20-07

20,5 cm / 8 1/8"

14-355-25-07

24,5 cm / 9 5/8"

## Schwammzangen

Sponge Forceps  
Pinzas para tapones  
Pincas pour éponges  
Pinze per tamponi e sponge

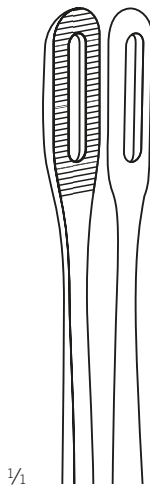
## Tupfer- und Kornzangen

Cotton Swap Forceps  
Pinzas para tampones y curaciones  
Pincas à tampons et à pansements  
Pinze per tamponi e per medicazione



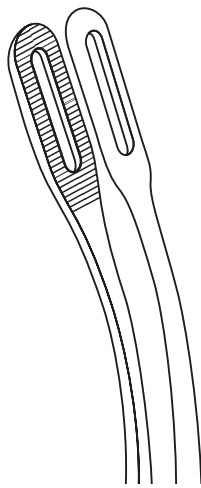
1/2

Förster  
14-360-25-07 -  
14-361-25-07



1/4

14-360-25-07  
25 cm / 9 7/8"

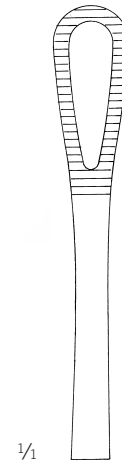


14-361-25-07  
25 cm / 9 7/8"



1/2

Rampley  
14-370-18-07 -  
14-370-25-07



1/4

14-370-18-07  
18 cm / 7 1/8"

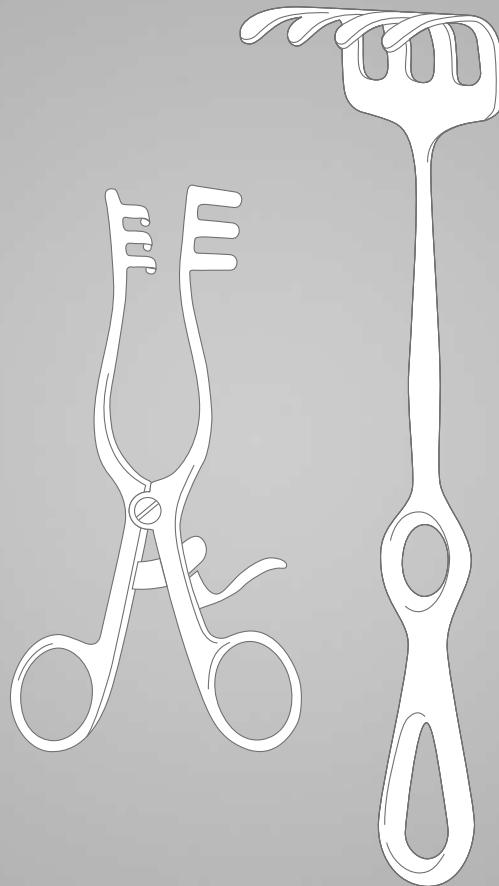


14-370-25-07  
24,5 cm / 9 5/8"



Wundhaken  
Retractors  
Separadores  
Ecarteurs  
Divaricatori

# 15



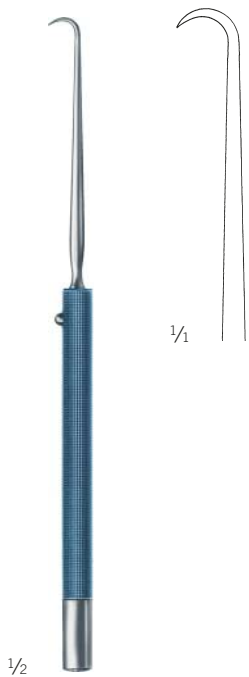
# Mikrohäkchen, Hauthäkchen

Micro Hooklets, Skin Hooks

Micro Ganchitos, Ganchitos de piel

Micro Crochetes, Crochetes pour le peau

Micro Divaricatori, Divaricatori per pelle



Rasse  
15-006-10-07  
16 cm / 6 2/8"



Graefe  
15-066-01-07 -  
15-066-02-07  
15 cm / 5 7/8"



15-066-01-07  
scharf  
sharp  
agudo  
pointu  
acuto



15-066-02-07  
stumpf  
blunt  
romo  
mousse  
smusso



15-068-01-07 -  
15-068-04-07  
16 cm / 6 2/8"  
scharf  
sharp  
agudo  
pointu  
acuto



**Fig. 1**  
15-068-01-07



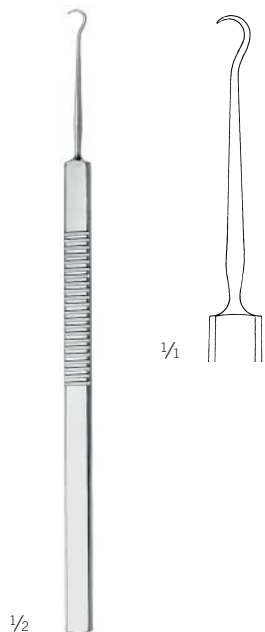
**Fig. 2**  
15-068-02-07



**Fig. 3**  
15-068-03-07



**Fig. 4**  
15-068-04-07



Rasse  
15-068-05-07  
16 cm / 6 2/8"



## Hauthäkchen, Wundhäkchen

Skin Hooks, Hooklets  
 Ganchitos de piel, Ganchitos  
 Crochetes pour le peau, Crochetes  
 Divaricatori per pelle, Divaricatori

## Wundhaken












Retractors  
 Separadores  
 Écarteurs  
 Divaricatori



O'Connor  
 15-070-16-07  
 16 cm / 6 2/8"  
 scharf  
 sharp  
 agudo  
 pointu  
 acuto

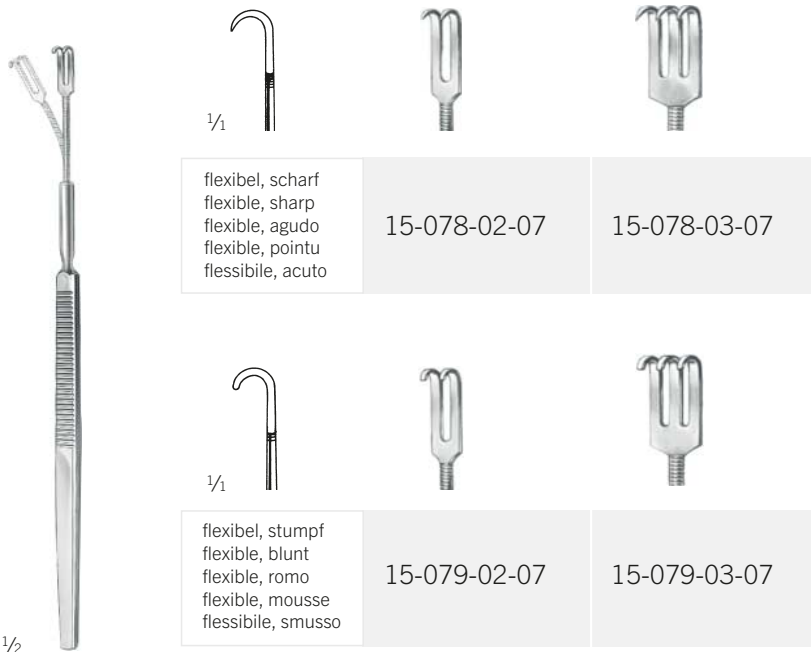


Guthrie  
 15-072-01-07 -  
 15-072-02-07  
 16 cm / 6 2/8"  
 scharf  
 sharp  
 agudo  
 pointu  
 acuto

|  |  |   |   |   |   |
|--|--|---|---|---|---|
| <br>1/2 | <br>1/4 |  |  |  |  |
|  | scharf<br>sharp<br>agudo<br>pointu<br>acuto  | 15-074-01-07  | 15-074-02-07  | 15-074-03-07  | 15-074-04-07  |
| 15-074-01-07 -<br>15-075-04-07<br>16,5 cm / 6 4/8"<br>1/2                                  | <br>1/4 |  |  |  |  |
|  | stumpf<br>blunt<br>romo<br>mousse<br>smusso  | 15-075-01-07  | 15-075-02-07  | 15-075-03-07  | 15-075-04-07  |

# Wundhäkchen

Hooklets  
Ganchitos  
Crochetes  
Divaricatori



15-078-02-07 -  
15-079-03-07  
15,5 cm / 6 1/8"



15-086-04-07 -  
15-087-04-07  
16,5 cm / 6 5/8"

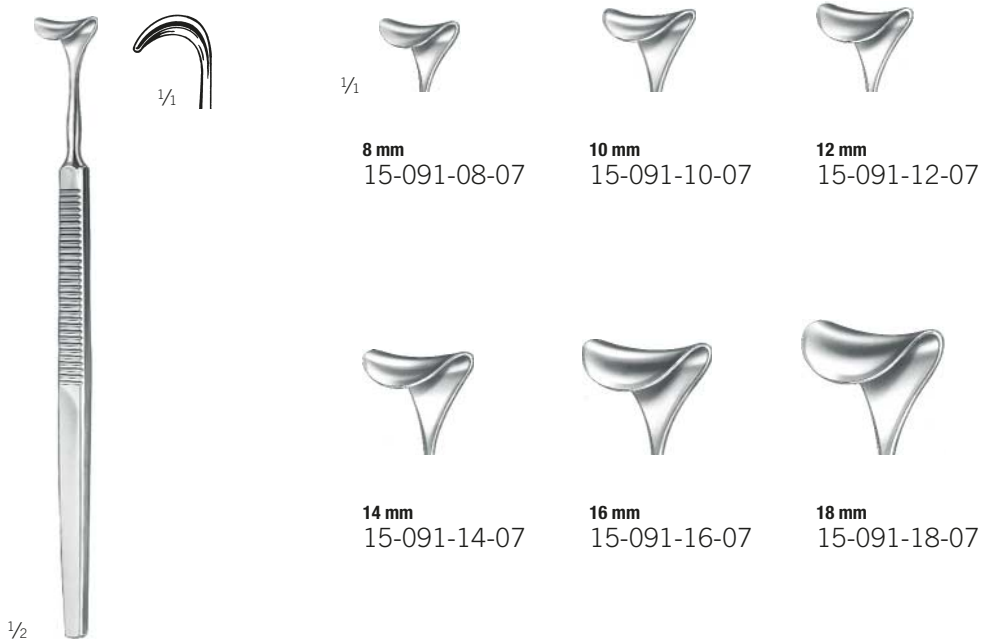
15-088-12-07  
12 cm / 4 6/8"  
Gefäßhäkchen  
Vessel Hook  
Ganchito vascular  
Micro-Ecarteurs pour vaisseaux  
Divaricatore vascolare

## Sattelhäkchen

Saddle Hooks  
Ganchos en forma de silla  
Ecarteurs sous forme de selle  
Divaricatori a forma di sella

## Wundhaken

Retractors  
Separadores  
Ecarteurs  
Divaricatori



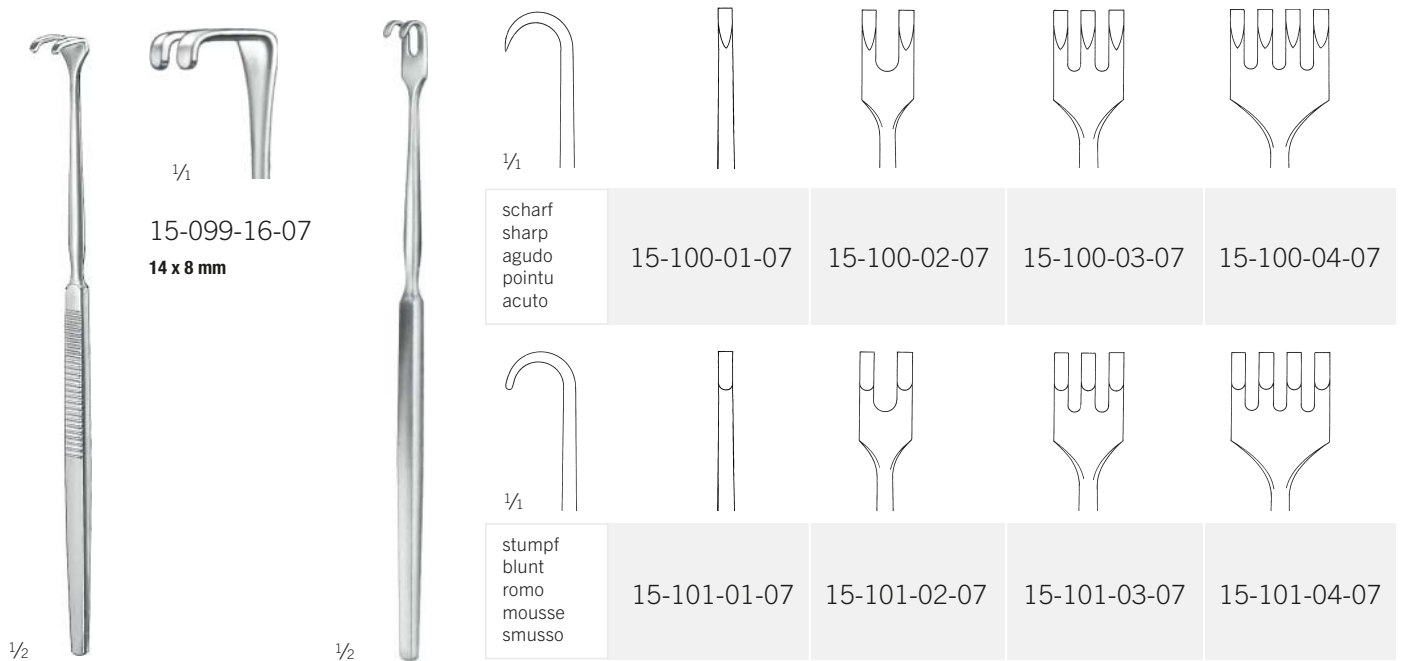
Desmarres  
15-091-08-07 -  
15-091-18-07  
16 cm / 6 2/8"



Langenbeck-Mini  
15-095-10-07 -  
15-095-22-07  
16 cm / 6 2/8"

# Wundhäkchen

Hooklets  
Ganchitos  
Crochetes  
Divaricatori



15-099-16-07

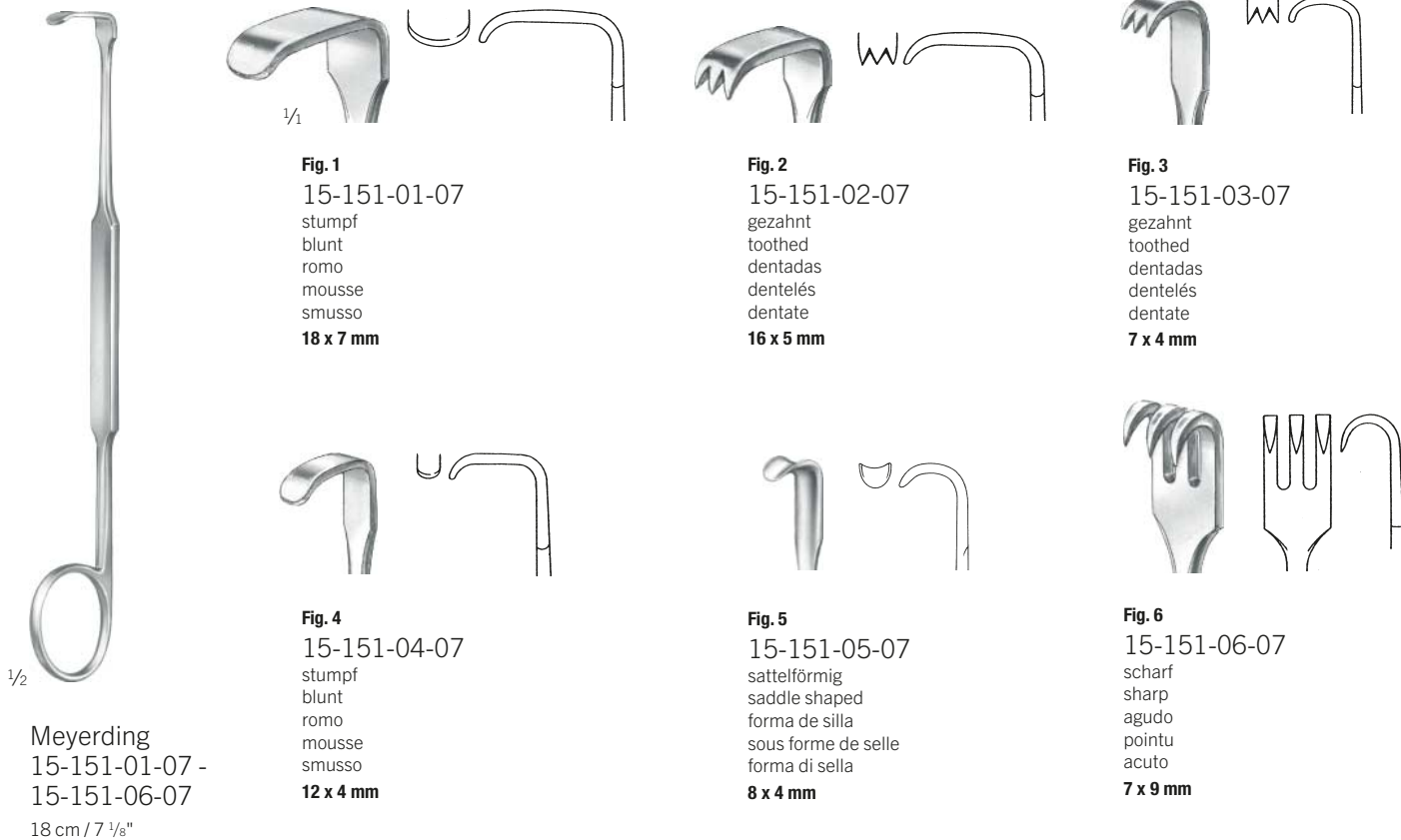
16 cm / 6 2/8"

stumpf  
blunt  
romo  
mousse  
smusso

15-100-01-07 -

15-101-04-07

16,5 cm / 6 4/8"



## Wundhäkchen

Hooklets  
Ganchitos  
Crochetes  
Divaricatori

## Wundhaken

Retractors  
Separadores  
Ecarteurs  
Divaricatori



**Fig. 1**  
15-161-01-07  
20 x 6 mm

**Fig. 2**  
15-161-02-07  
10 x 6 mm

8 x 4,5 mm

15 x 5,5 mm

11 x 4 mm

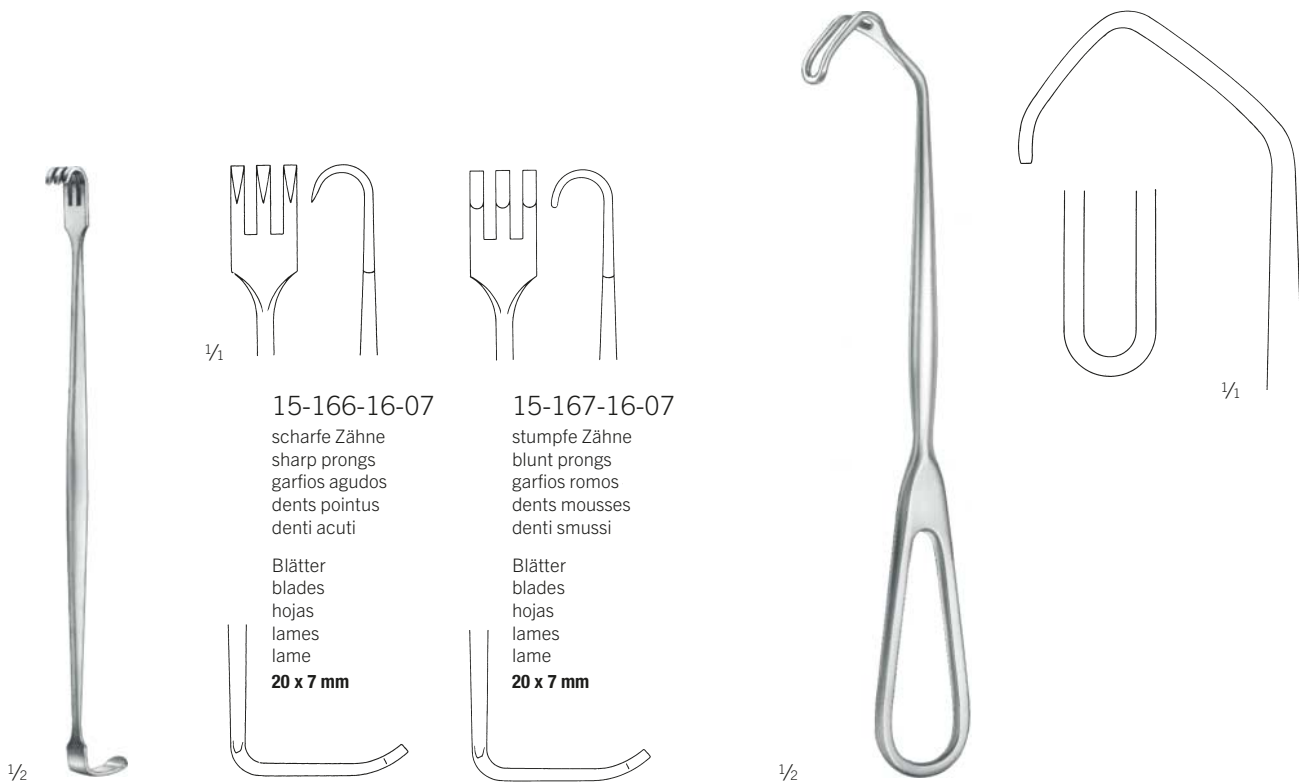
19 x 6 mm

Senn-Green  
15-161-01-07 -  
15-161-02-07  
16 cm / 6 2/8"

Ragnell-Davis  
15-164-14-07  
15 cm / 5 7/8"

Ragnell-Davis  
15-164-24-07  
10,5 cm / 4 1/8"

15



1/2

1/2

15-166-16-07  
scharfe Zähne  
sharp prongs  
garfios agudos  
dents pointus  
denti acuti

15-167-16-07  
stumpfe Zähne  
blunt prongs  
garfios romos  
dents mousses  
denti smussi

Blätter  
blades  
hojas  
lames  
lame  
20 x 7 mm

Blätter  
blades  
hojas  
lames  
lame  
20 x 7 mm

Senn-Miller  
15-166-16-07 -  
15-167-16-07  
16 cm / 6 2/8"

Cushing  
15-170-20-07  
20,5 cm / 8 1/8"

## Sattelhäkchen

Saddle Hooks

Ganchos en forma de silla

Ecarteurs sous forme de selle

Divaricatori a forma di sella



Cushing  
15-171-08-07 -  
15-171-18-07  
20,5 cm / 8 1/8"

Cushing  
15-172-08-07 -  
15-172-18-07  
24 cm / 9 4/8"

## Sattelhäkchen

Saddle Hooks  
Ganchos en forma de silla  
Ecarteurs sous forme de selle  
Divaricatori a forma di sella

## Wundhaken

Retractors  
Separadores  
Ecarteurs  
Divaricatori



1/1



**4 mm**  
15-174-04-07



**6 mm**  
15-174-06-07



**8 mm**  
15-174-08-07



**11 mm**  
15-174-11-07



**15 mm**  
15-174-15-07



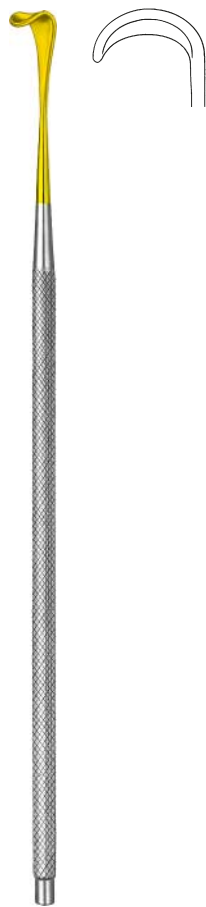
**17 mm**  
15-174-17-07



**20 mm**  
15-174-20-07



**23 mm**  
15-174-23-07



1/2

Gil-Vernet  
15-174-04-07 -  
15-174-23-07  
24 cm / 9 4/8"  
biegsamer Schaft  
malleable shaft  
vástagó maleable  
tige malleable  
asta malleabili

## Venenhäkchen, Wundhäkchen

Vein Hooks

Ganchitos para venas

Ecarteurs pour veines

Divaricatori per veni



Brom  
15-176-01-07 -  
15-176-02-07  
19 cm / 7 4/8"



Strandell-Stille  
15-191-01-07 -  
15-191-02-07  
19 cm / 7 4/8"

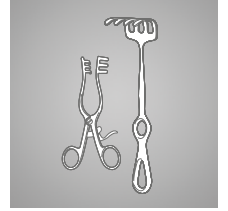


## Wundhaken, Wundhäkchen

Retractors  
Separadores  
Ecarteurs  
Divaricatori

## Wundhaken

Retractors  
Separadores  
Ecarteurs  
Divaricatori



1/1

15-195-01-07  
13 x 6 mm



15-195-02-07  
12 x 11 mm



15-195-03-07  
15 x 12 mm



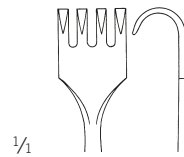
1/2

Klapp

15-195-01-07 -  
15-195-03-07

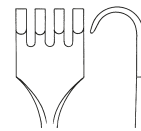
17,5 cm / 6 7/8"

stumpf  
blunt  
romo  
mousse  
smusso



1/1

15-200-04-07  
scharf  
sharp  
agudo  
pointu  
acuto



15-201-04-07  
stumpf  
blunt  
romo  
mousse  
smusso



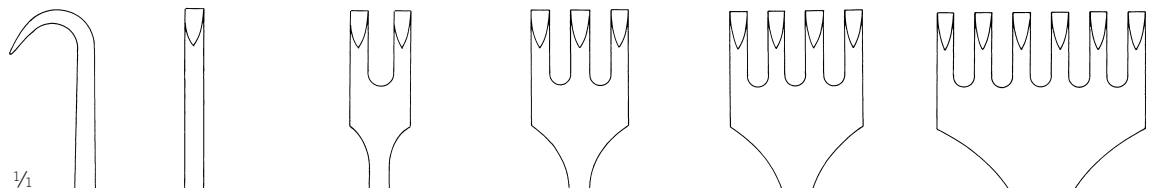
1/2

15-200-04-07 -  
15-201-04-07

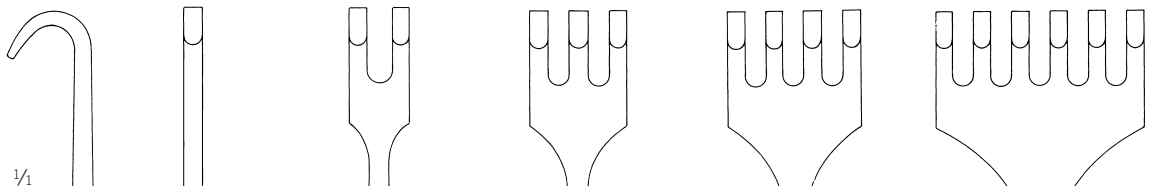
16,5 cm / 6 1/2"

# Wundhaken

Retractors  
 Separadores  
 Ecarteurs  
 Divaricatori



|   |              |              |              |              |              |
|---|--------------|--------------|--------------|--------------|--------------|
| scharf<br>sharp<br>agudo<br>pointu<br>acuto | 15-210-01-07 | 15-210-02-07 | 15-210-03-07 | 15-210-04-07 | 15-210-06-07 |
|---|--------------|--------------|--------------|--------------|--------------|



|   |              |              |              |              |              |
|---|--------------|--------------|--------------|--------------|--------------|
| stumpf<br>blunt<br>romo<br>mousse<br>smusso | 15-211-01-07 | 15-211-02-07 | 15-211-03-07 | 15-211-04-07 | 15-211-06-07 |
|---|--------------|--------------|--------------|--------------|--------------|



1/2

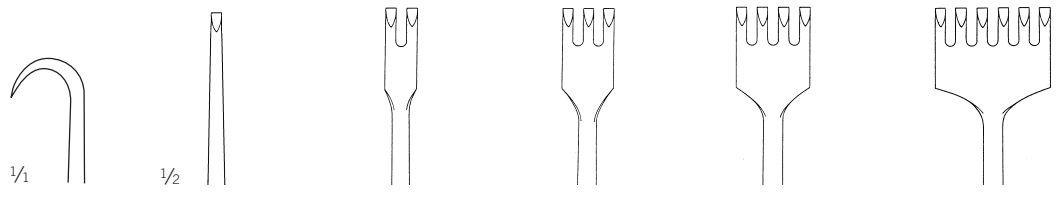
Volkman  
 15-210-01-07 -  
 15-211-06-07  
 21,5cm / 8 4/8"

# Wundhaken

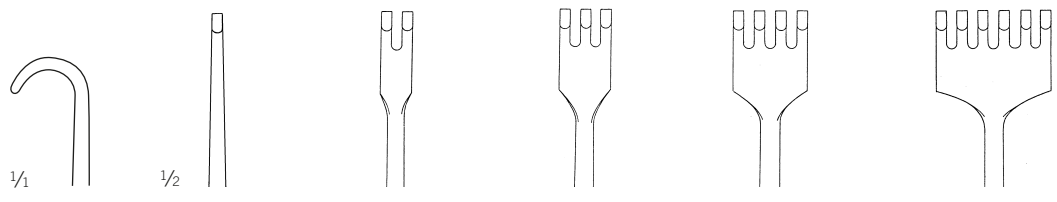
Retractors  
Separadores  
Ecarteurs  
Divaricatori

# Wundhaken

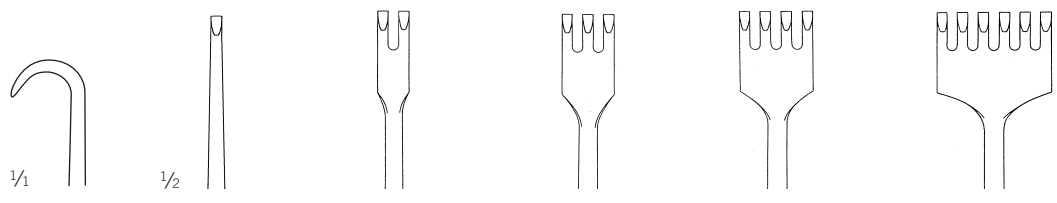
Retractors  
Separadores  
Ecarteurs  
Divaricatori



|   |              |              |              |              |              |
|---|--------------|--------------|--------------|--------------|--------------|
| scharf<br>sharp<br>agudo<br>pointu<br>acuto | 15-220-01-07 | 15-220-02-07 | 15-220-03-07 | 15-220-04-07 | 15-220-06-07 |
|---|--------------|--------------|--------------|--------------|--------------|



|   |              |              |              |              |              |
|---|--------------|--------------|--------------|--------------|--------------|
| stumpf<br>blunt<br>romo<br>mousse<br>smusso | 15-221-01-07 | 15-221-02-07 | 15-221-03-07 | 15-221-04-07 | 15-221-06-07 |
|---|--------------|--------------|--------------|--------------|--------------|



|   |              |              |              |              |              |
|---|--------------|--------------|--------------|--------------|--------------|
| halbscharf<br>semi-sharp<br>semi-agudo<br>semi-pointu<br>semi-acuto | 15-222-01-07 | 15-222-02-07 | 15-222-03-07 | 15-222-04-07 | 15-222-06-07 |
|---|--------------|--------------|--------------|--------------|--------------|



1/2

Volkman  
15-220-01-07 -  
15-222-06-07  
22,5 cm / 8 7/8"

15

## Wundhaken

Retractors  
Separadores  
Ecarteurs  
Divaricatori



1/2

Volkman  
15-230-01-07  
21,5 cm / 8 1/8"

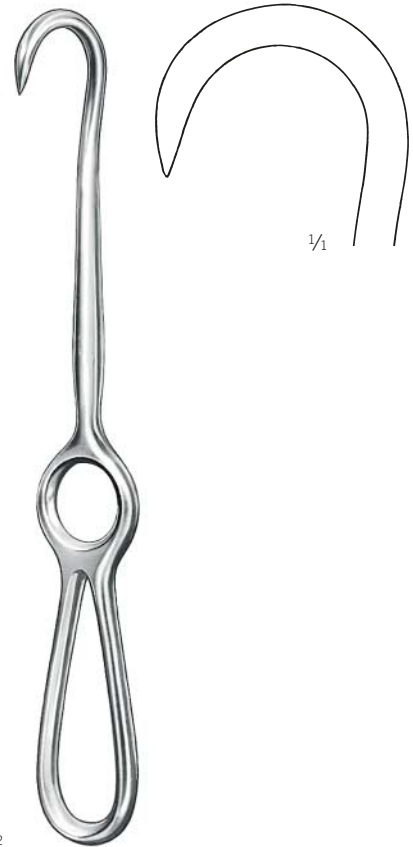
scharf  
sharp  
agudo  
pointu  
acuto



1/2

Volkman  
15-231-01-07  
21,5 cm / 8 1/8"

stumpf  
blunt  
romo  
mousse  
smusso



1/2

15-232-01-07  
21,5 cm / 8 1/8"

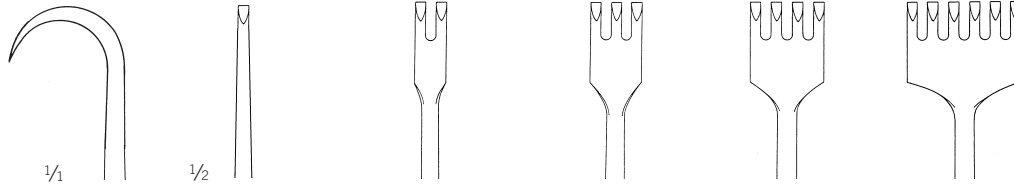
scharf  
sharp  
agudo  
pointu  
acuto

## Wundhaken

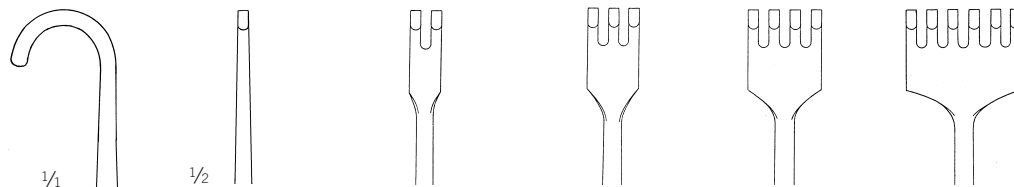
Retractors  
Separadores  
Ecarteurs  
Divaricatori

## Wundhaken

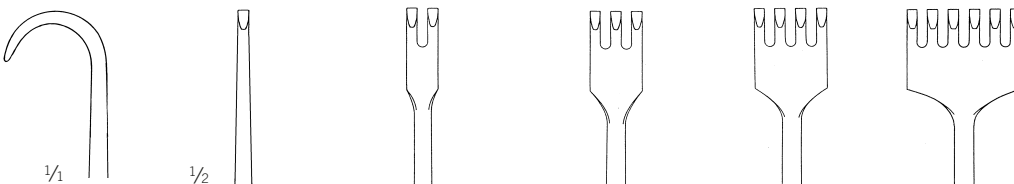
Retractors  
Separadores  
Ecarteurs  
Divaricatori



|   |              |              |              |              |              |
|---|--------------|--------------|--------------|--------------|--------------|
| scharf<br>sharp<br>agudo<br>pointu<br>acuto | 15-240-01-07 | 15-240-02-07 | 15-240-03-07 | 15-240-04-07 | 15-240-06-07 |
|---|--------------|--------------|--------------|--------------|--------------|



|   |              |              |              |              |              |
|---|--------------|--------------|--------------|--------------|--------------|
| stumpf<br>blunt<br>romo<br>mousse<br>smusso | 15-241-01-07 | 15-241-02-07 | 15-241-03-07 | 15-241-04-07 | 15-241-06-07 |
|---|--------------|--------------|--------------|--------------|--------------|



|   |              |              |              |              |              |
|---|--------------|--------------|--------------|--------------|--------------|
| halbscharf<br>semi-sharp<br>semi-agudo<br>semi-pointu<br>semi-acuto | 15-242-01-07 | 15-242-02-07 | 15-242-03-07 | 15-242-04-07 | 15-242-06-07 |
|---|--------------|--------------|--------------|--------------|--------------|



1/2

Kocher  
15-240-01-07 -  
15-242-06-07  
22,5 cm / 8 7/8"

15

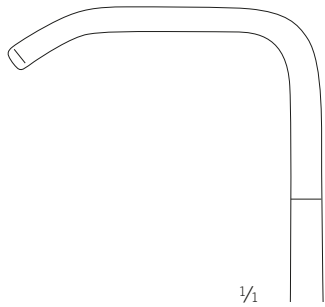
## Wundhaken

Retractors  
Separadores  
Ecarteurs  
Divaricatori



1/2

Ollier  
15-251-03-07  
24,5 cm / 9 5/8"  
stumpf  
blunt  
romo  
mousse  
smusso



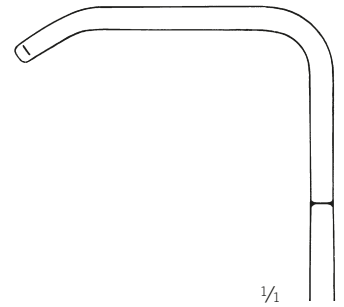
1/1

37 x 30 mm



1/2

Ollier  
15-253-04-07  
23 cm / 9"  
stumpf  
blunt  
romo  
mousse  
smusso



1/1

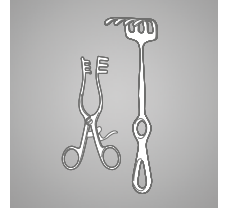
39 x 60 mm

## Wundhaken

Retractors  
Separadores  
Ecarteurs  
Divaricatori

## Wundhaken

Retractors  
Separadores  
Ecarteurs  
Divaricatori



33 x 20 mm

1/2, \_

Wassmund  
15-261-02-07  
20,5 cm / 8 1/8"



25 x 40 mm  
15-266-08-07

scharf  
sharp  
agudo  
pointu  
acuto

25 x 40 mm  
15-267-08-07

stumpf  
blunt  
romo  
mousse  
smusso

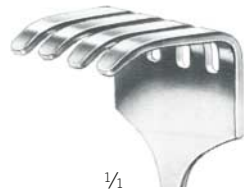
1/2

Körte  
15-266-08-07-  
15-267-08-07  
24,5 cm / 9 5/8"

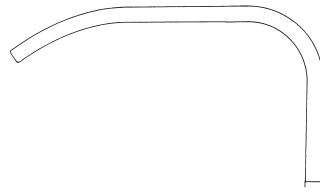
15

## Wundhaken

Retractors  
Separadores  
Ecarteurs  
Divaricatori



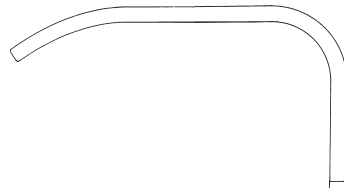
1/1



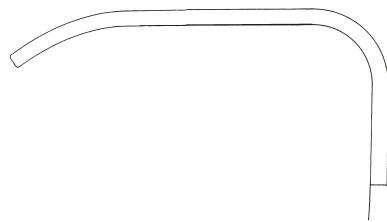
**40 x 40 mm**  
15-281-04-07



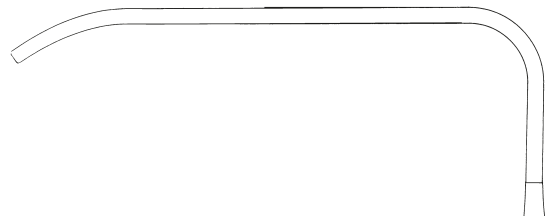
**45 x 50 mm**  
15-283-05-07



**50 x 60 mm**  
15-287-06-07



**70 x 70 mm**  
15-289-07-07



1/2

Israel  
15-281-04-07 -  
15-289-07-07  
24,5 cm / 9 5/8"

stumpf  
blunt  
romo  
mousse  
smusso

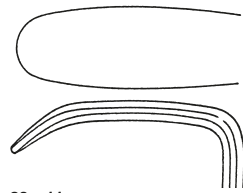
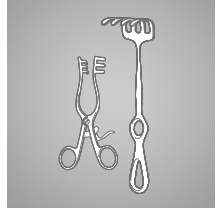


# Wundhaken

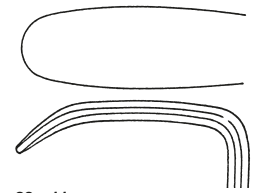
Retractors  
Separadores  
Ecarteurs  
Divaricatori

# Wundhaken

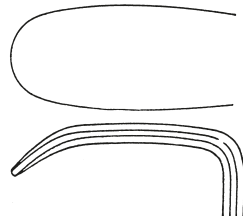
Retractors  
Separadores  
Ecarteurs  
Divaricatori



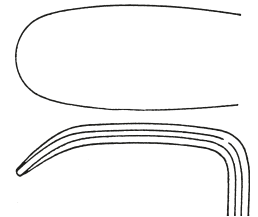
30 x 11 mm  
15-291-01-07



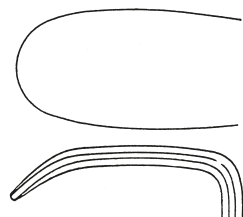
30 x 11 mm  
15-293-01-07



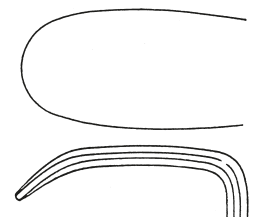
30 x 14 mm  
15-291-02-07



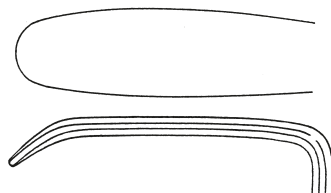
30 x 14 mm  
15-293-02-07



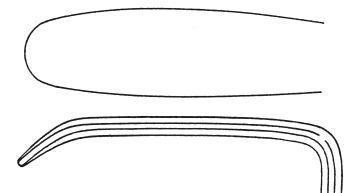
30 x 15 mm  
15-291-03-07



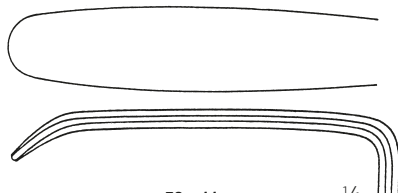
30 x 15 mm  
15-293-03-07



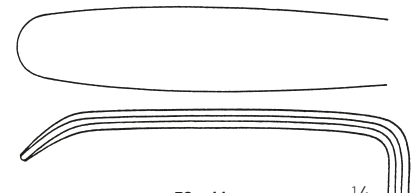
40 x 11 mm  
15-291-04-07



40 x 11 mm  
15-293-04-07



50 x 11 mm <sup>1/1</sup>  
15-291-05-07



50 x 11 mm <sup>1/1</sup>  
15-293-05-07



1/2

Langenbeck  
15-291-01-07 -  
15-291-05-07  
22 cm / 8 5/8"



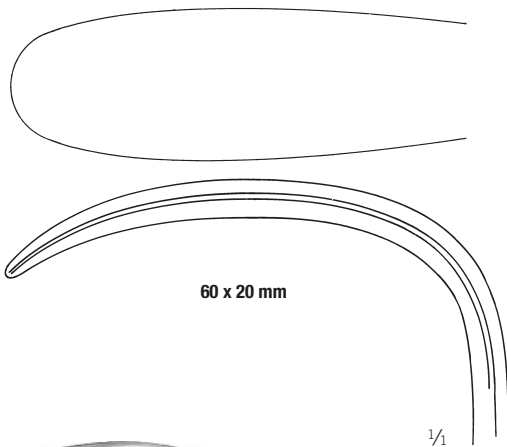
1/2

Langenbeck  
15-293-01-07 -  
15-293-05-07  
22 cm / 8 5/8"

15

## Wundhaken

Retractors  
Separadores  
Ecarteurs  
Divaricatori



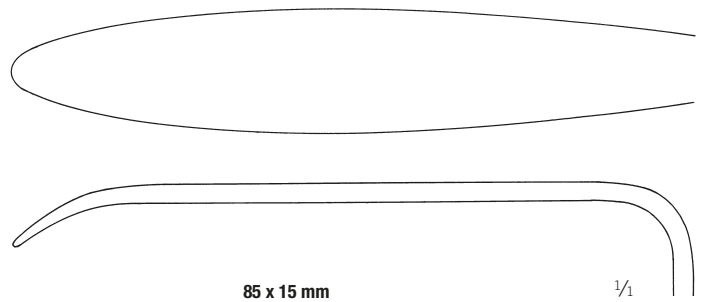
60 x 20 mm

1/4



1/2

Langenbeck  
15-295-21-07  
21 cm / 8 3/8"



85 x 15 mm

1/4



1/2

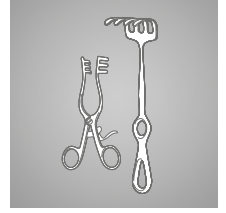
Langenbeck  
15-297-21-07  
22,5 cm / 8 7/8"

## Wundhaken

Retractors  
Separadores  
Ecarteurs  
Divaricatori

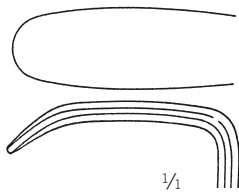
## Wundhaken

Retractors  
Separadores  
Ecarteurs  
Divaricatori



1/2

Langenbeck  
15-299-01-07  
21 cm / 8 3/8"

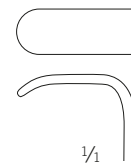


43 x 13 mm  
15-299-01-07

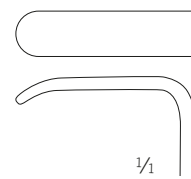


1/2

Langenbeck-Green  
15-301-16-07 -  
15-301-25-07  
16 cm / 6 2/8"



6 x 16 mm  
15-301-16-07



6 x 25 mm  
15-301-25-07

## Wundhaken

Retractors  
Separadores  
Ecarteurs  
Divaricatori



Lahey  
15-307-19-07  
19,5 cm / 7 5/8"



Little  
15-313-20-07  
20,5 cm / 8 1/8"

## Wundhaken

Retractors  
Separadores  
Ecarteurs  
Divaricatori

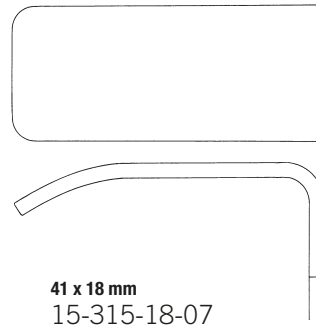
## Wundhaken

Retractors  
Separadores  
Ecarteurs  
Divaricatori

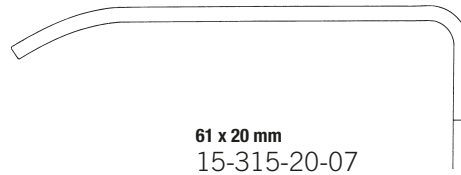


1/2

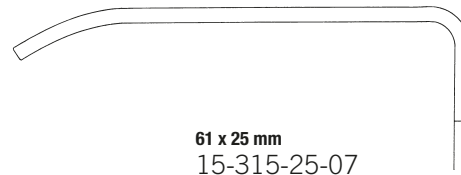
Kocher  
15-315-18-07 -  
15-315-40-07  
23 cm / 9"



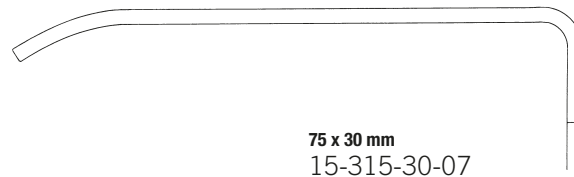
41 x 18 mm  
15-315-18-07



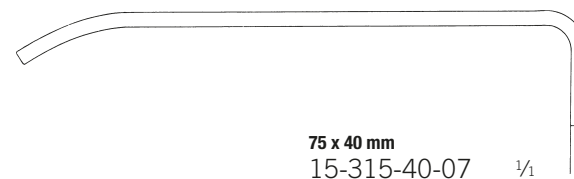
61 x 20 mm  
15-315-20-07



61 x 25 mm  
15-315-25-07



75 x 30 mm  
15-315-30-07



75 x 40 mm  
15-315-40-07 1/2

15

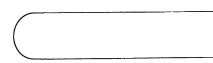
# Wundhaken

Retractors  
Separadores  
Ecarteurs  
Divaricatori

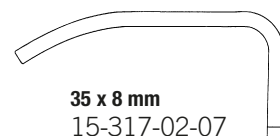
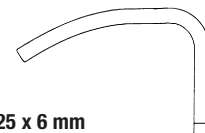


1/2

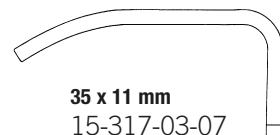
Kocher-Langenbeck  
15-317-01-07 -  
15-317-09-07  
21,5 cm / 8 4/8"



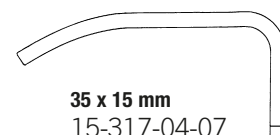
**25 x 6 mm**  
15-317-01-07



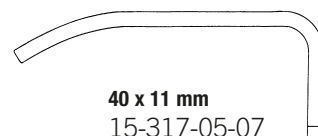
**35 x 8 mm**  
15-317-02-07



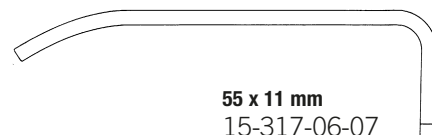
**35 x 11 mm**  
15-317-03-07



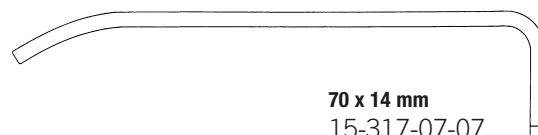
**35 x 15 mm**  
15-317-04-07



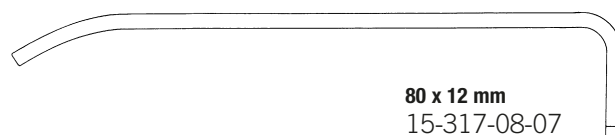
**40 x 11 mm**  
15-317-05-07



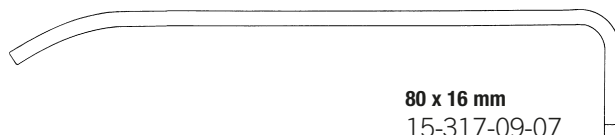
**55 x 11 mm**  
15-317-06-07



**70 x 14 mm**  
15-317-07-07



**80 x 12 mm**  
15-317-08-07



**80 x 16 mm**  
15-317-09-07

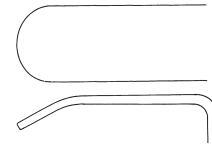
1/4

## Wundhaken

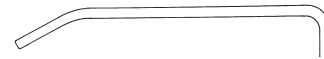
Retractors  
Separadores  
Ecarteurs  
Divaricatori

## Wundhaken

Retractors  
Separadores  
Ecarteurs  
Divaricatori



**25 x 10 mm**  
15-319-01-07



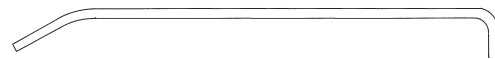
**40 x 13 mm**  
15-319-02-07



**60 x 13 mm**  
15-319-03-07



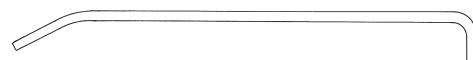
**40 x 18 mm**  
15-319-04-07



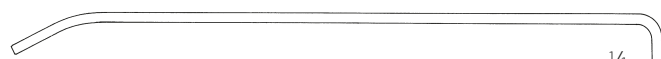
**60 x 18 mm**  
15-319-05-07



**85 x 18 mm**  
15-319-06-07



**60 x 25 mm**  
15-319-07-07



**85 x 25 mm**  
15-319-08-07

$\frac{1}{2}$



$\frac{1}{2}$

Kocher-Langenbeck  
15-319-01-07 -  
15-319-08-07  
21,5 cm / 8  $\frac{4}{8}$ "

15

## Wundhaken

Retractors  
Separadores  
Ecarteurs  
Divaricatori



1/2

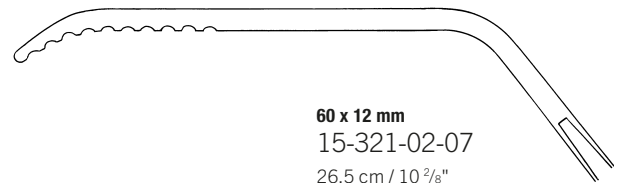
Zenker  
15-321-00-07 -  
15-321-03-07



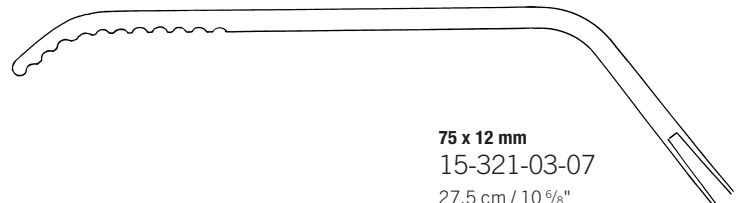
**10 x 3 mm**  
Mini-Zenker  
15-321-00-07  
18 cm / 7"



**35 x 9 mm**  
15-321-01-07  
25 cm / 9 3/4"



**60 x 12 mm**  
15-321-02-07  
26,5 cm / 10 2/8"



**75 x 12 mm**  
15-321-03-07  
27,5 cm / 10 6/8"



## Wundhaken

Retractors  
Separadores  
Ecarteurs  
Divaricatori

## Wundhaken

Retractors  
Separadores  
Ecarteurs  
Divaricatori

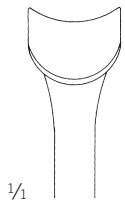
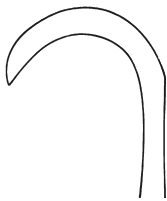


15



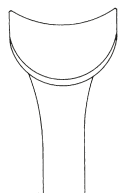
1/2

Kocher  
15-325-01-07 -  
15-325-02-07  
21,5 cm / 8 1/8"

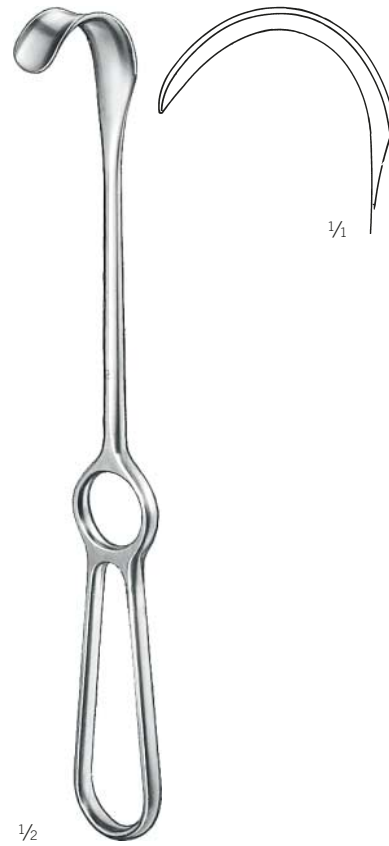


1/4

20 x 12 mm  
15-325-01-07

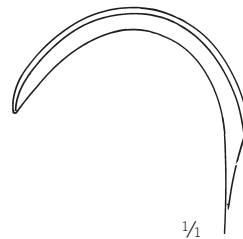


23 x 14 mm  
15-325-02-07

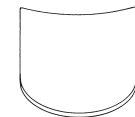


1/2

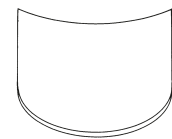
Kocher  
15-351-01-07 -  
15-351-03-07



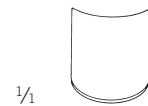
1/4



40 x 15 mm  
15-351-02-07  
23 cm / 9"



40 x 20 mm  
15-351-03-07  
23 cm / 9"

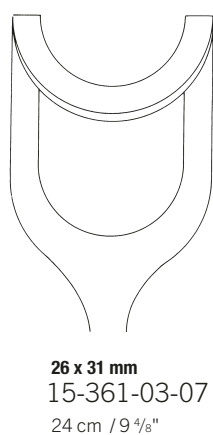
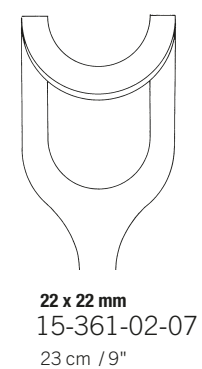
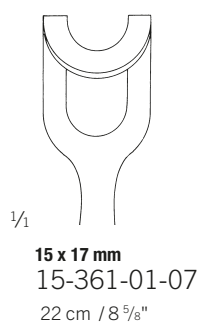


1/4

40 x 10 mm  
15-351-01-07  
22 cm / 8 5/8"

# Wundhaken

Retractors  
Separadores  
Ecarteurs  
Divaricatori



Middeldorpf  
15-361-01-07 -  
15-361-03-07



**Fig. 1**  
**15-381-01-01**  
26 cm / 10 2/8"  
**25 x 20 mm**  
**30 x 28 mm**

**Fig. 2**  
**15-381-02-01**  
27,5 cm / 10 7/8"  
**43 x 38 mm**  
**63 x 44 mm**

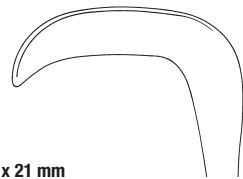
Richardson-Eastman  
15-381-01-01 -  
15-381-02-01

## Wundhaken

Retractors  
Separadores  
Ecarteurs  
Divaricatori

## Wundhaken

Retractors  
Separadores  
Ecarteurs  
Divaricatori



**25 x 21 mm**  
15-391-01-01  
23,5 cm / 9 <sup>2</sup>/<sub>8</sub>"



1/2

Richardson  
15-391-01-01 -  
15-391-03-01



**30 x 29 mm**  
15-391-02-01  
24 cm / 9 <sup>4</sup>/<sub>8</sub>"



**38 x 40 mm**  
15-391-03-01  
24 cm / 9 <sup>4</sup>/<sub>8</sub>" 1/1



1/2

Richardson  
15-395-24-01  
24 cm / 9 <sup>4</sup>/<sub>8</sub>"



**62 x 50 mm**

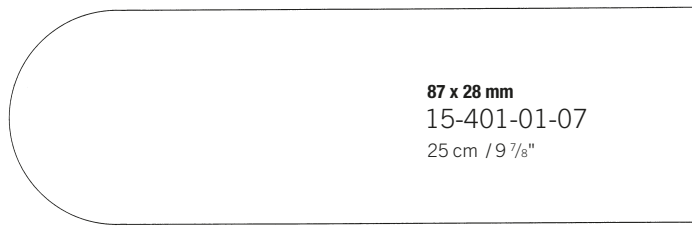
1/2

Kelly  
15-397-26-01  
26 cm / 10 <sup>2</sup>/<sub>8</sub>"

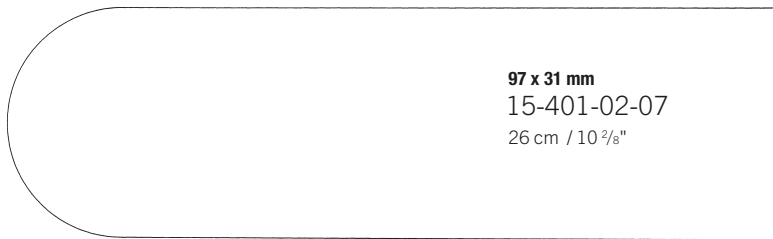
15

# Wundhaken

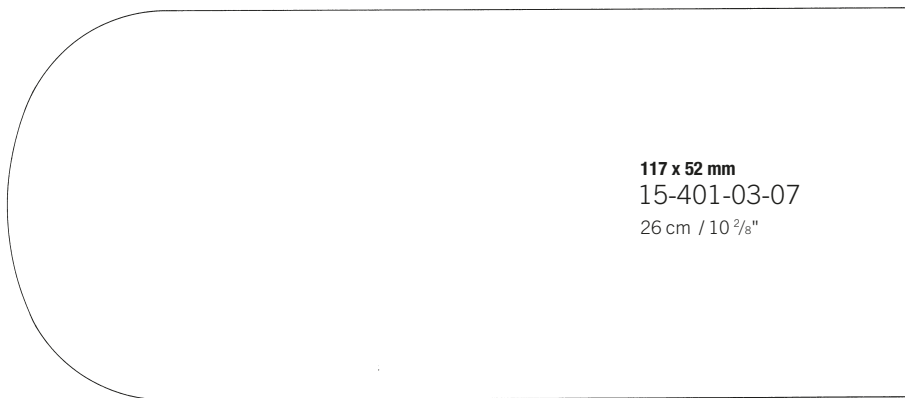
Retractors  
Separadores  
Ecarteurs  
Divaricatori



**87 x 28 mm**  
15-401-01-07  
25 cm / 9 <sup>7</sup>/<sub>8</sub>"



**97 x 31 mm**  
15-401-02-07  
26 cm / 10 <sup>2</sup>/<sub>8</sub>"



**117 x 52 mm**  
15-401-03-07  
26 cm / 10 <sup>2</sup>/<sub>8</sub>"



1/2

1/4

Doyen-Stillie  
15-401-01-07 -  
15-401-03-07

## Wundhaken

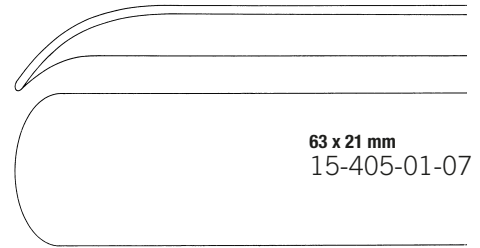
Retractors  
Separadores  
Ecarteurs  
Divaricatori

## Wundhaken

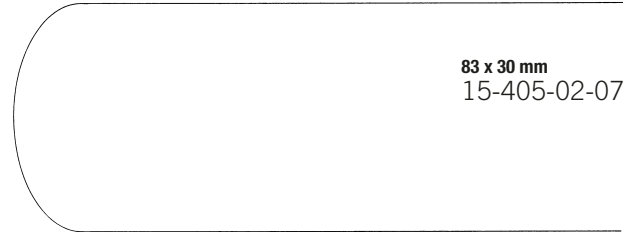
Retractors  
Separadores  
Ecarteurs  
Divaricatori



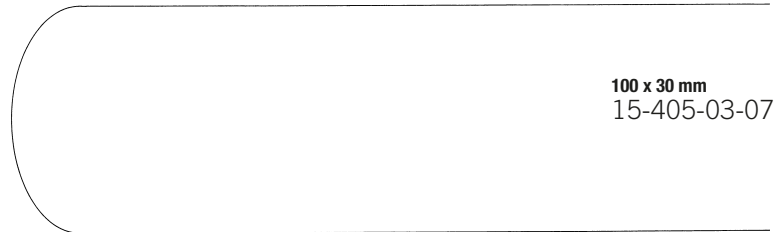
Hösel  
15-405-01-07 -  
15-405-06-07  
26 cm / 10 <sup>2</sup>/<sub>8</sub>"



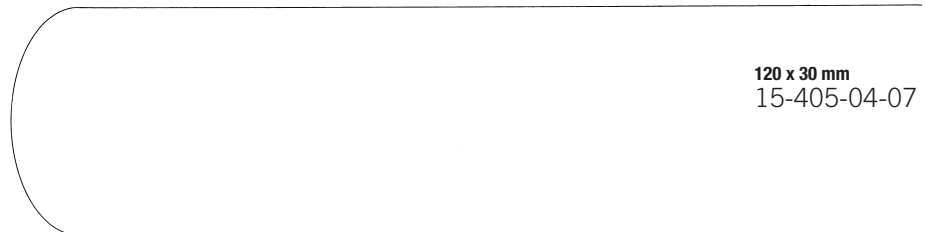
**63 x 21 mm**  
15-405-01-07



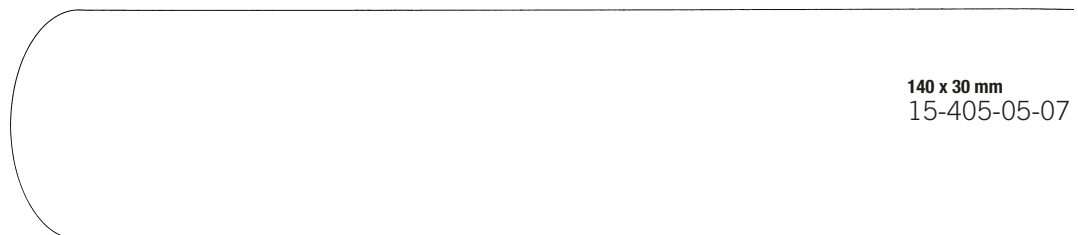
**83 x 30 mm**  
15-405-02-07



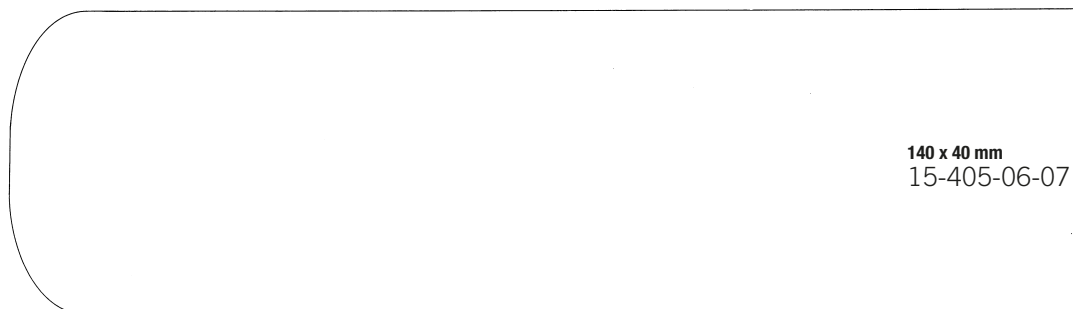
**100 x 30 mm**  
15-405-03-07



**120 x 30 mm**  
15-405-04-07



**140 x 30 mm**  
15-405-05-07



**140 x 40 mm**  
15-405-06-07

1/4

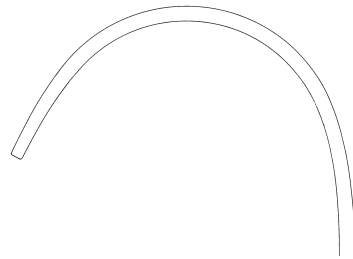
15

# Wundhaken

Retractors  
Separadores  
Ecarteurs  
Divaricatori



1/2



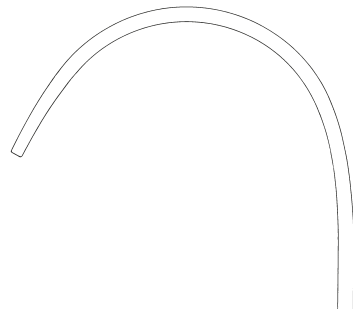
**43 x 45 mm**  
15-441-01-07  
27 cm / 10 5/8"



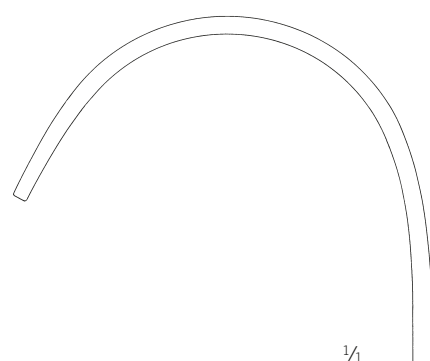
1/2



**52 x 50 mm**  
15-441-02-07  
27 cm / 10 5/8"



**52 x 70 mm**  
15-441-03-07  
28 cm / 11"



1/1

Middeldorpf  
15-441-01-07 -  
15-441-03-07

## Wundhaken

Retractors  
Separadores  
Ecarteurs  
Divaricatori

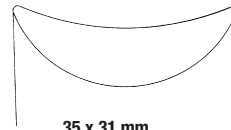
## Wundhaken

Retractors  
Separadores  
Ecarteurs  
Divaricatori

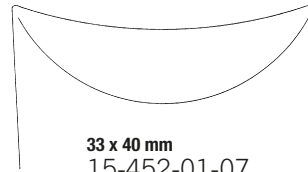


1/2

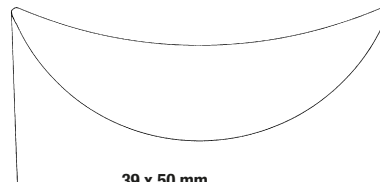
Fritsch  
15-452-00-07 -  
15-452-05-07



35 x 31 mm  
15-452-00-07  
23,5 cm / 9 2/8"



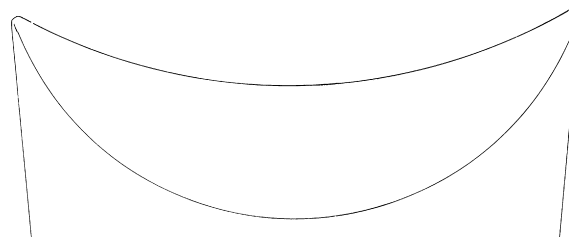
33 x 40 mm  
15-452-01-07  
24 cm / 9 4/8"



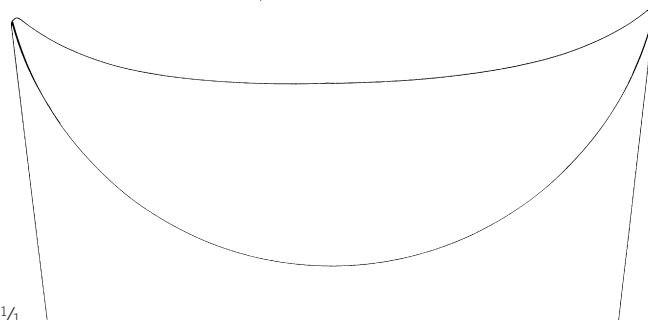
39 x 50 mm  
15-452-02-07  
25 cm / 9 5/8"



45 x 63 mm  
15-452-03-07  
25 cm / 9 5/8"



45 x 75 mm  
15-452-04-07  
25,5 cm / 10"



1/2

53 x 85 mm  
15-452-05-07  
25,5 cm / 10"

15

## Wundhaken

Retractors  
Separadores  
Ecarteurs  
Divaricatori



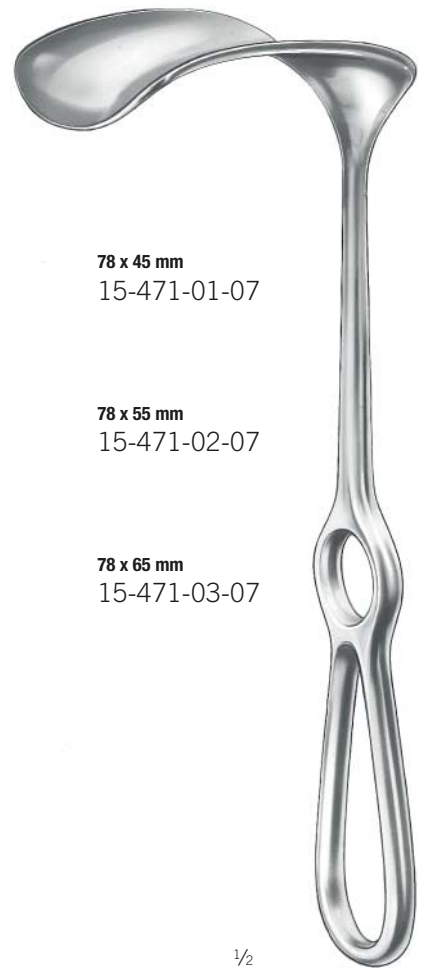
1/2

**45 x 88 mm**  
Doyen  
15-461-25-01  
24 cm / 9 4/8"



1/2

**70 x 25 mm**  
Kocher  
15-469-22-07  
23,5 cm / 9 3/8"



**78 x 45 mm**  
15-471-01-07

**78 x 55 mm**  
15-471-02-07

**78 x 65 mm**  
15-471-03-07

1/2

Kocher  
15-471-01-07 -  
15-471-03-07  
25 cm / 9 7/8"

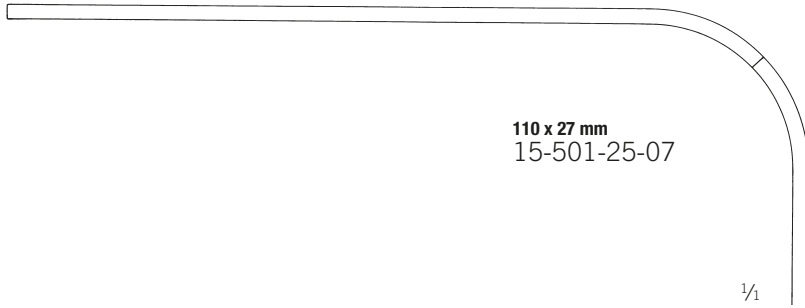


## Wundhaken

Retractors  
Separadores  
Ecarteurs  
Divaricatori

## Wundhaken

Retractors  
Separadores  
Ecarteurs  
Divaricatori



110 x 27 mm  
15-501-25-07

1/4



115 x 22 mm  
15-505-28-07

115 x 28 mm  
15-507-28-07

1/4



1/2

Martin  
15-501-25-07  
26,5 cm / 10 3/8"



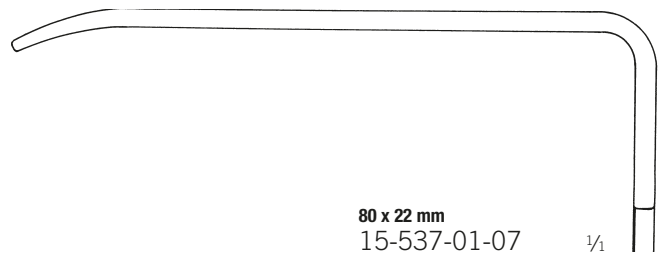
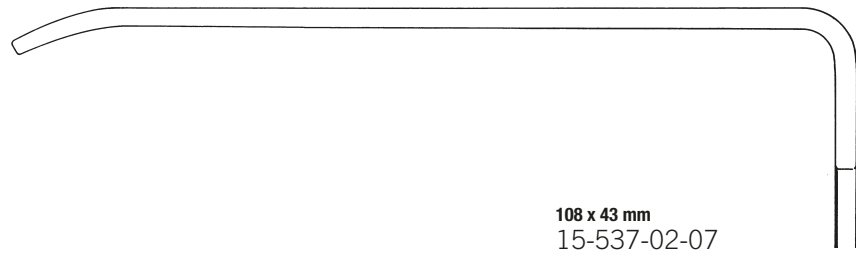
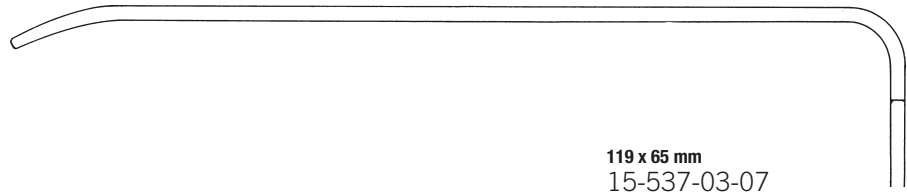
1/2

Simon  
15-505-28-07 -  
15-507-28-07  
28 cm / 11"

15

## Wundhaken

Retractors  
Separadores  
Ecarteurs  
Divaricatori



1/2

Coryllos  
15-537-01-07 -  
15-537-03-07  
24 cm / 9 4/8"

## Scapulahaken

Scapula Retractors  
Separadores para escápula  
Ecarteurs pour scapula  
Divaricatori per scapola

## Wundhaken

Retractors  
Separadores  
Ecarteurs  
Divaricatori



1/2

**80 x 54 mm**  
Davidson  
15-545-01-07  
19 cm / 7 1/8"

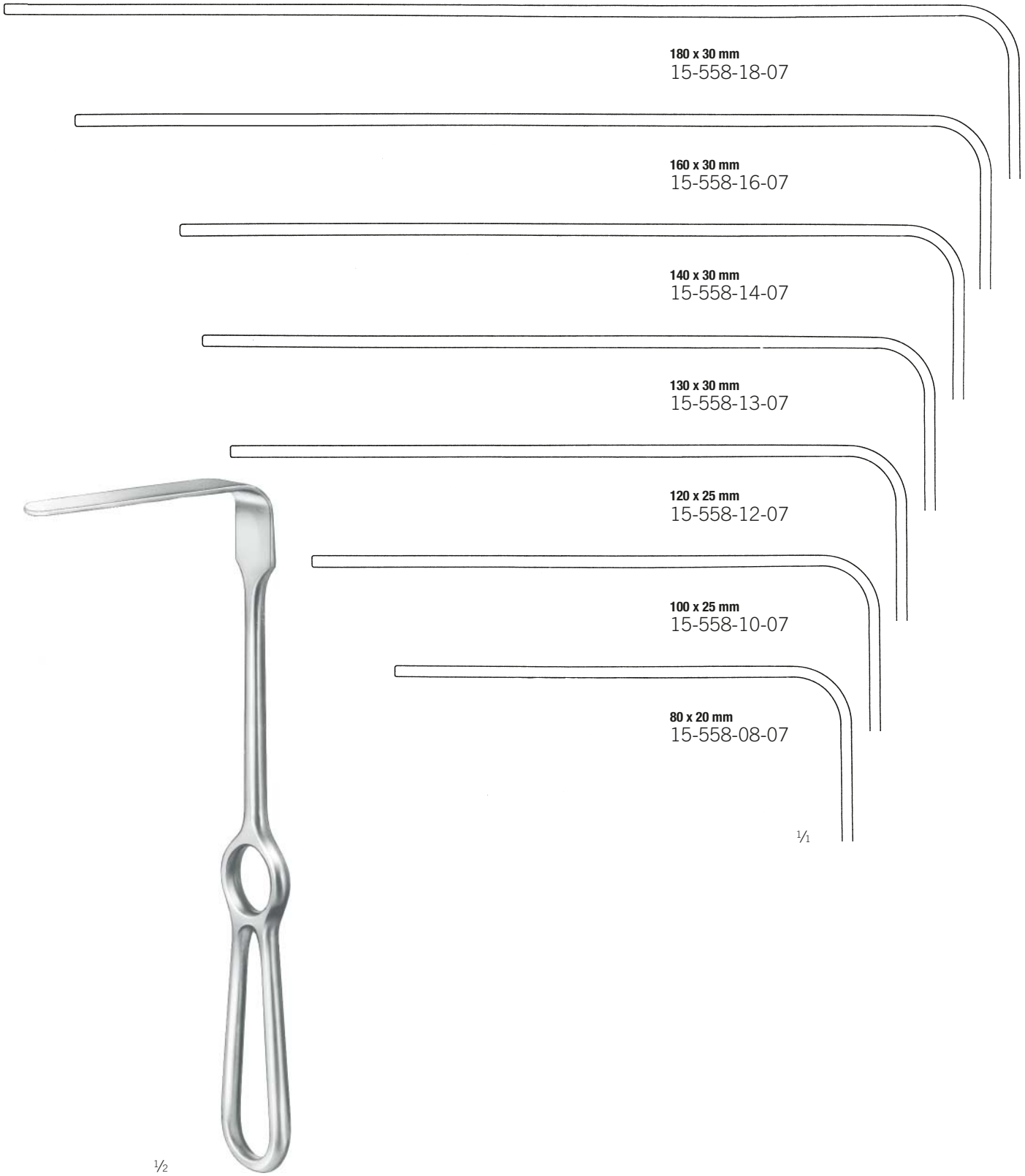


1/2

**75 x 93 mm**  
Davidson  
15-545-02-07  
18,5 cm / 7 2/8"

# Wundhaken

Retractors  
Separadores  
Ecarteurs  
Divaricatori



180 x 30 mm  
15-558-18-07

160 x 30 mm  
15-558-16-07

140 x 30 mm  
15-558-14-07

130 x 30 mm  
15-558-13-07

120 x 25 mm  
15-558-12-07

100 x 25 mm  
15-558-10-07

80 x 20 mm  
15-558-08-07

1/2

Brunner  
15-558-08-07 -  
15-558-18-07  
25,5 cm / 10 "

1/1

## Wundhaken

Retractors  
Separadores  
Ecarteurs  
Divaricatori

## Wundhaken

Retractors  
Separadores  
Ecarteurs  
Divaricatori



180 x 30 mm  
15-559-18-07

160 x 30 mm  
15-559-16-07

140 x 25 mm  
15-559-14-07

120 x 25 mm  
15-559-12-07

100 x 20 mm  
15-559-10-07

80 x 20 mm  
15-559-08-07



1/2

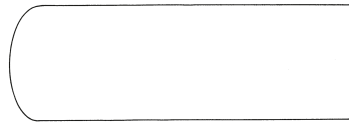
Brunner  
15-559-08-07 -  
15-559-18-07  
25,5 cm / 10 "

15

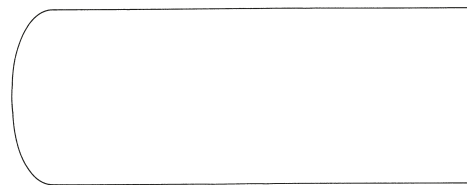
1/1

## Wundhaken

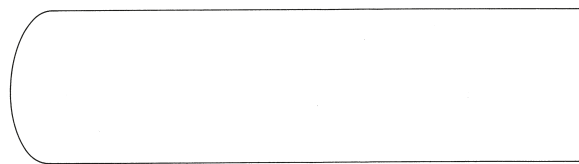
Retractors  
Separadores  
Ecarteurs  
Divaricatori



**45 x 15 mm**  
15-561-01-07



**60 x 23 mm**  
15-561-02-07



**72 x 20 mm**  
15-561-03-07

1/4



1/2

Sauerbruch  
15-561-01-07 -  
15-561-03-07  
22,5 cm / 8 7/8"

## Aortaklappenhaken

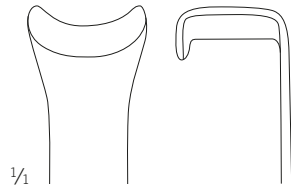
Aortic Valve Retractors  
Retractor de válvula aórtica  
Écarteurs pour valve aortique  
Retrattori per valvola aortica

## Wundhaken

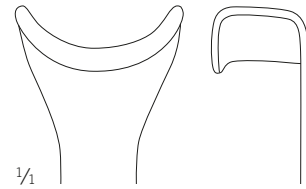
Retractors  
Separadores  
Écarteurs  
Divaricatori



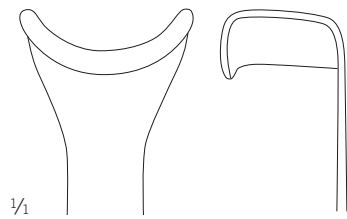
Sic



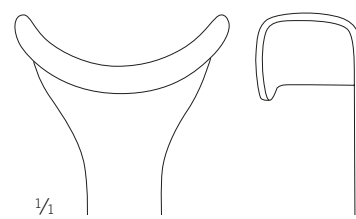
**Fig. 1**  
**13 x 16 mm**  
15-563-01-07  
26,5 cm / 10 <sup>3</sup>/<sub>8</sub>"



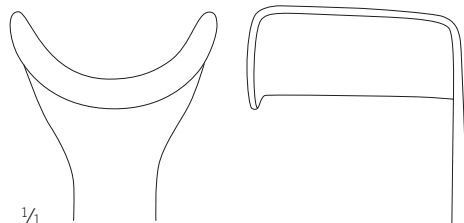
**Fig. 2**  
**11 x 22 mm**  
15-563-02-07  
27 cm / 10 <sup>5</sup>/<sub>8</sub>"



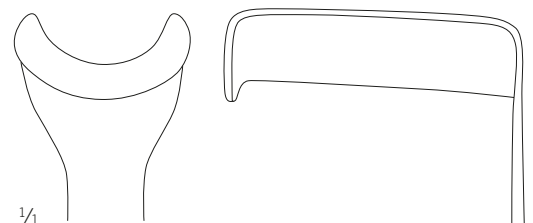
**Fig. 3**  
**15 x 23 mm**  
15-563-03-07  
27 cm / 10 <sup>5</sup>/<sub>8</sub>"



**Fig. 4**  
**12 x 28 mm**  
15-563-04-07  
27,5 cm / 10 <sup>7</sup>/<sub>8</sub>"



**Fig. 5**  
**27 x 27 mm**  
15-563-05-07  
27,5 cm / 10 <sup>7</sup>/<sub>8</sub>"



**Fig. 6**  
**38 x 24 mm**  
15-563-06-07  
27,5 cm / 10 <sup>7</sup>/<sub>8</sub>"



Ross  
15-563-01-07 -  
15-563-06-07

flexibler Schaft  
flexible shaft  
vástagó flexible  
tíge flexible  
asta flessibile

15

# Aortaklappenhaken

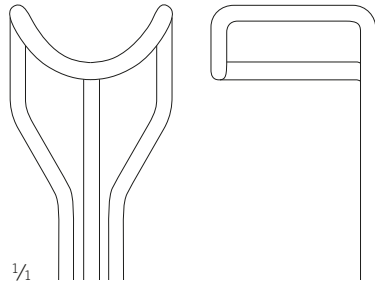
Aortic Valve Retractors

Retractor de válvula aórtica

Écarteurs pour valve aortique

Retrattori per valvola aortica

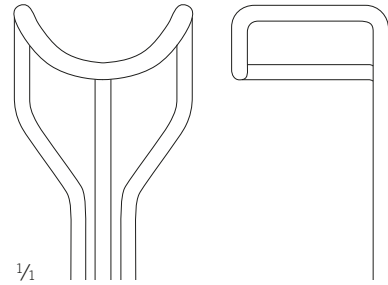
Sic



**Fig. 1**

**17 x 21 mm**

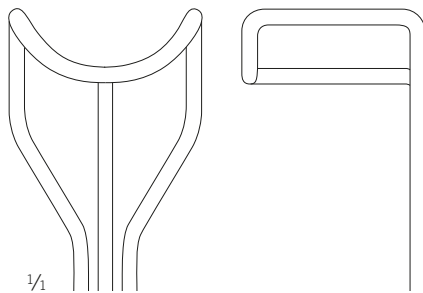
**15-564-01-07**



**Fig. 2**

**16 x 23 mm**

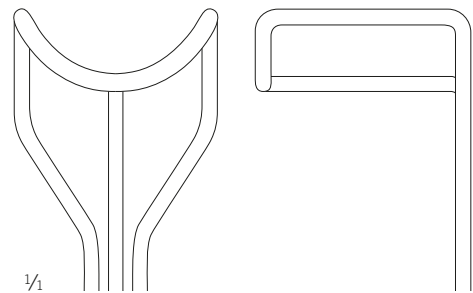
**15-564-02-07**



**Fig. 3**

**15-564-03-07**

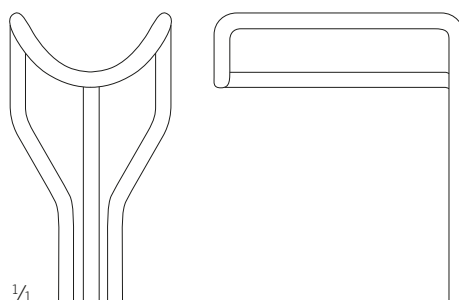
**20 x 25 mm**



**Fig. 4**

**15-564-04-07**

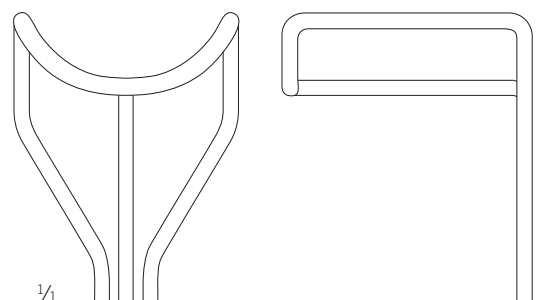
**24 x 27 mm**



**Fig. 5**

**15-564-05-07**

**28 x 20 mm**



**Fig. 6**

**15-564-06-07**

**28 x 29 mm**



Borowski  
15-564-01-07 -  
15-564-06-07  
27 cm / 10 5/8"

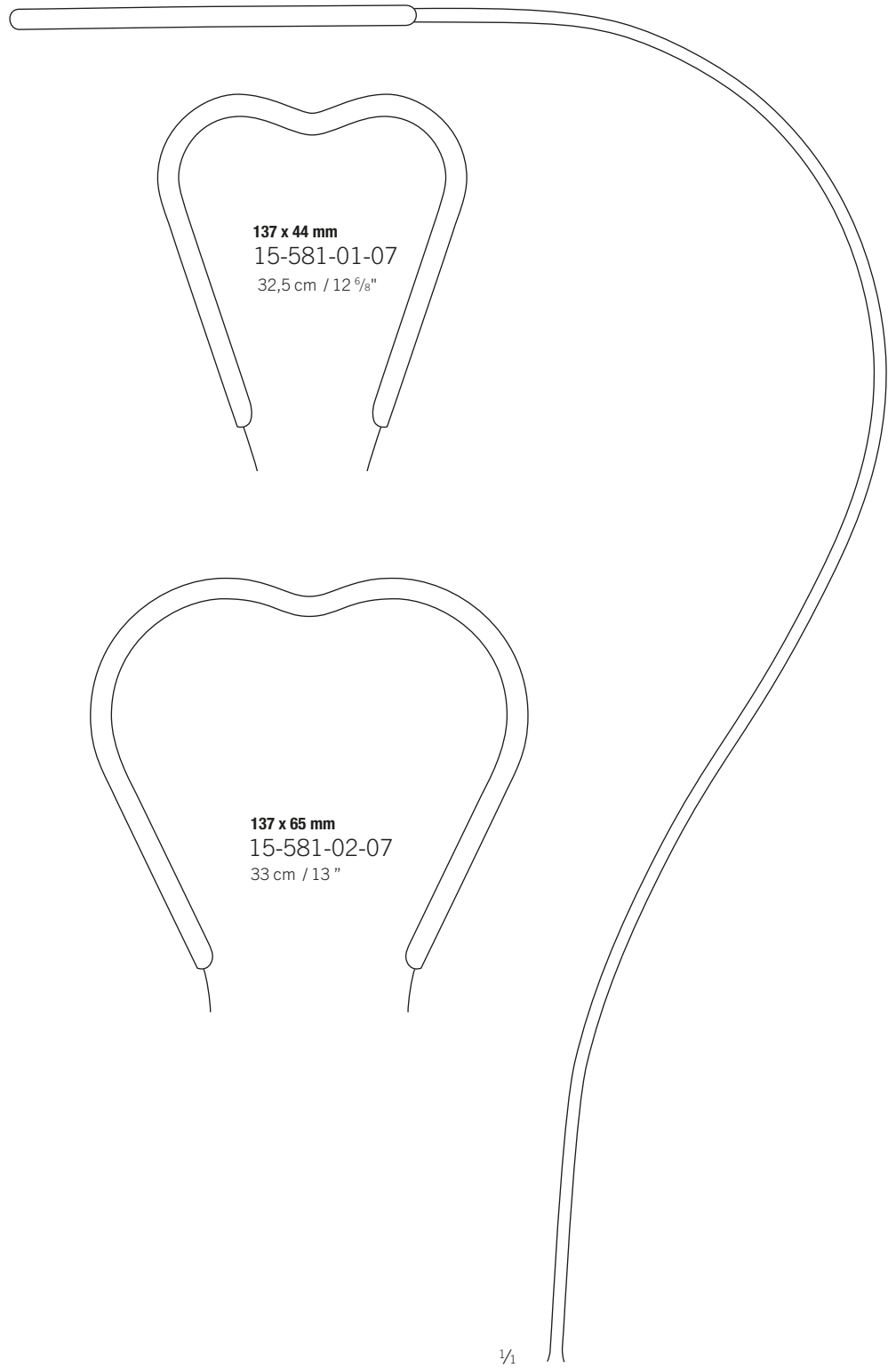


## Wundhaken

Retractors  
Separadores  
Ecarteurs  
Divaricatori

## Wundhaken

Retractors  
Separadores  
Ecarteurs  
Divaricatori



137 x 44 mm  
15-581-01-07  
32,5 cm / 12 6/8"

137 x 65 mm  
15-581-02-07  
33 cm / 13"



1/2

1/1

Harrington  
15-581-01-07 -  
15-581-02-07

15

## Wundhaken

Retractors  
Separadores  
Ecarteurs  
Divaricatori



1/2

**16 mm**  
Deaver  
15-591-00-07  
18 cm / 7 1/8"

**19 mm**  
Deaver  
15-591-01-07  
18 cm / 7 1/8"

**22 mm**  
Deaver  
15-591-02-07  
21,5 cm / 8 4/8"

**25 mm**  
Deaver  
15-591-03-07  
26 cm / 10 2/8"

**25 mm**  
Deaver  
15-591-04-07  
30,5 cm / 12"

**25 mm**  
Deaver  
15-591-05-07  
33,5 cm / 13 3/8"

**25 mm**  
Deaver  
15-591-06-07  
34,5 cm / 13 5/8"

## Wundhaken

Retractors  
Separadores  
Ecarteurs  
Divaricatori

## Wundhaken

Retractors  
Separadores  
Ecarteurs  
Divaricatori



1/2

**38 mm**  
Deaver  
15-591-07-07  
32 cm / 12 5/8"



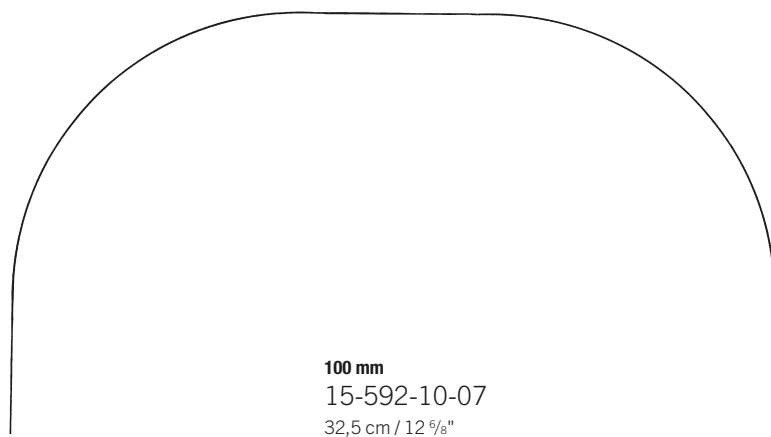
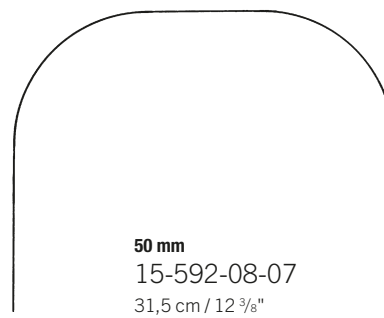
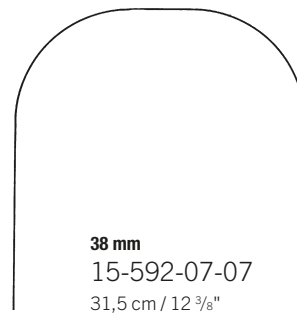
**50 mm**  
Deaver  
15-591-08-07  
31,5 cm / 12 3/8"



**75 mm**  
Deaver  
15-591-09-07  
31,5 cm / 12 3/8"

# Wundhaken

Retractors  
Separadores  
Ecarteurs  
Divaricatori



Deaver  
15-592-04-07 -  
15-592-10-07

## Atriumhaken

Atrium Retractors  
Separadores para atrio  
Ecarteurs pour atrium  
Divaricatori per atrio

## Wundhaken

Retractors  
Separadores  
Ecarteurs  
Divaricatori



1/2

**48 x 48 mm**  
Cooley  
15-593-01-01  
25 cm / 9 7/8"  
rechts  
right  
derecho  
droit  
destra



1/2

**48 x 48 mm**  
Cooley  
15-593-02-01  
25 cm / 9 7/8"  
rechts, gerieft  
right, serrated  
derecho, estriado  
droit, avec stries  
destra, con striatura

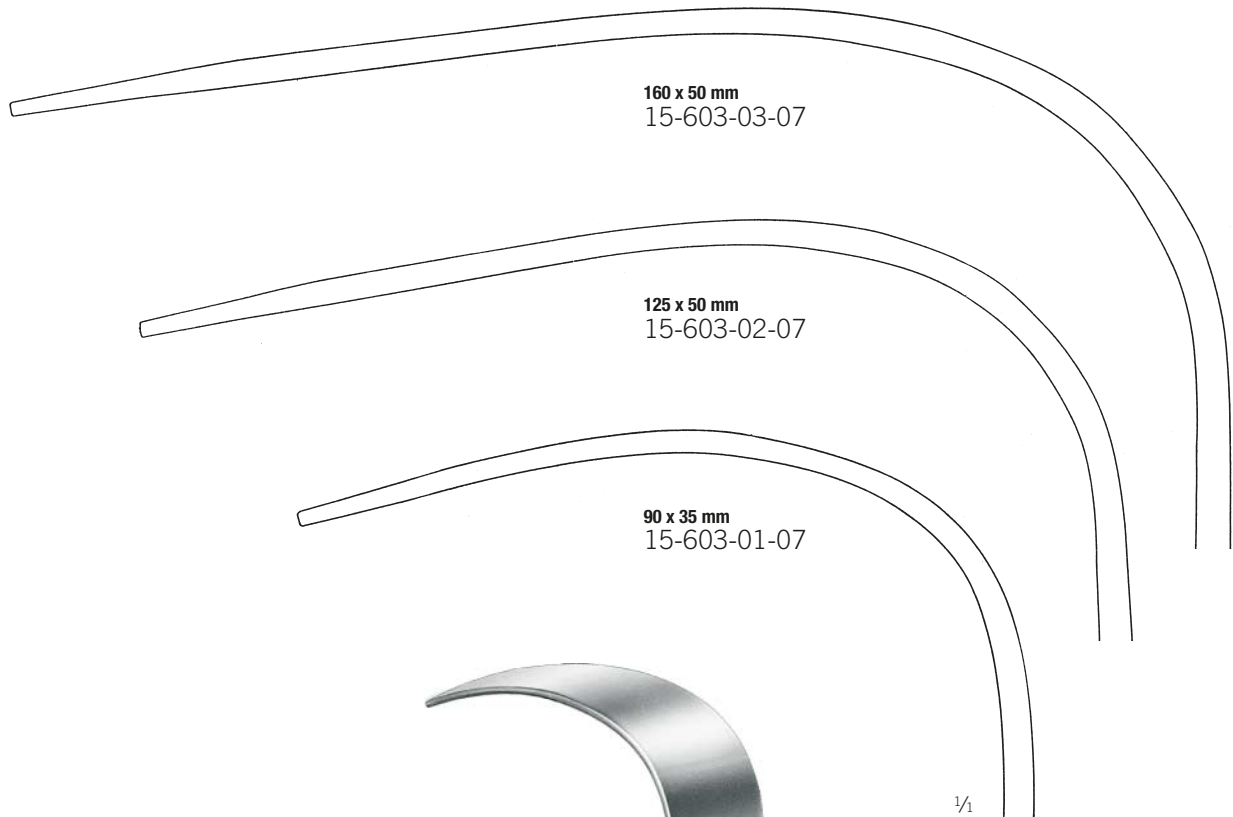


1/2

**30 x 48 mm**  
Cooley  
15-593-03-01  
27,5 cm / 10 7/8"  
links  
left  
izquierdo  
gauche  
sinistra

## Wundhaken

Retractors  
Separadores  
Ecarteurs  
Divaricatori



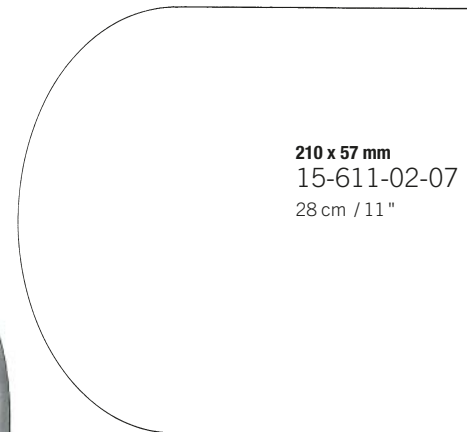
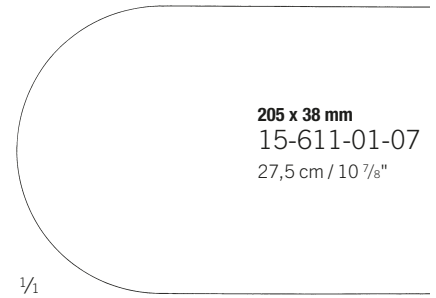
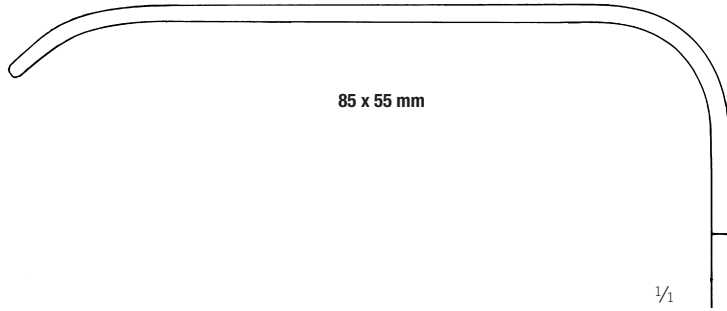
Mikulicz  
15-603-01-07 -  
15-603-03-07  
25 cm / 9 7/8"

## Wundhaken

Retractors  
Separadores  
Ecarteurs  
Divaricatori

## Wundhaken

Retractors  
Separadores  
Ecarteurs  
Divaricatori



Mikulicz  
15-607-26-07  
26 cm / 10 1/8"



Kelly  
15-611-01-07 -  
15-611-02-07

15

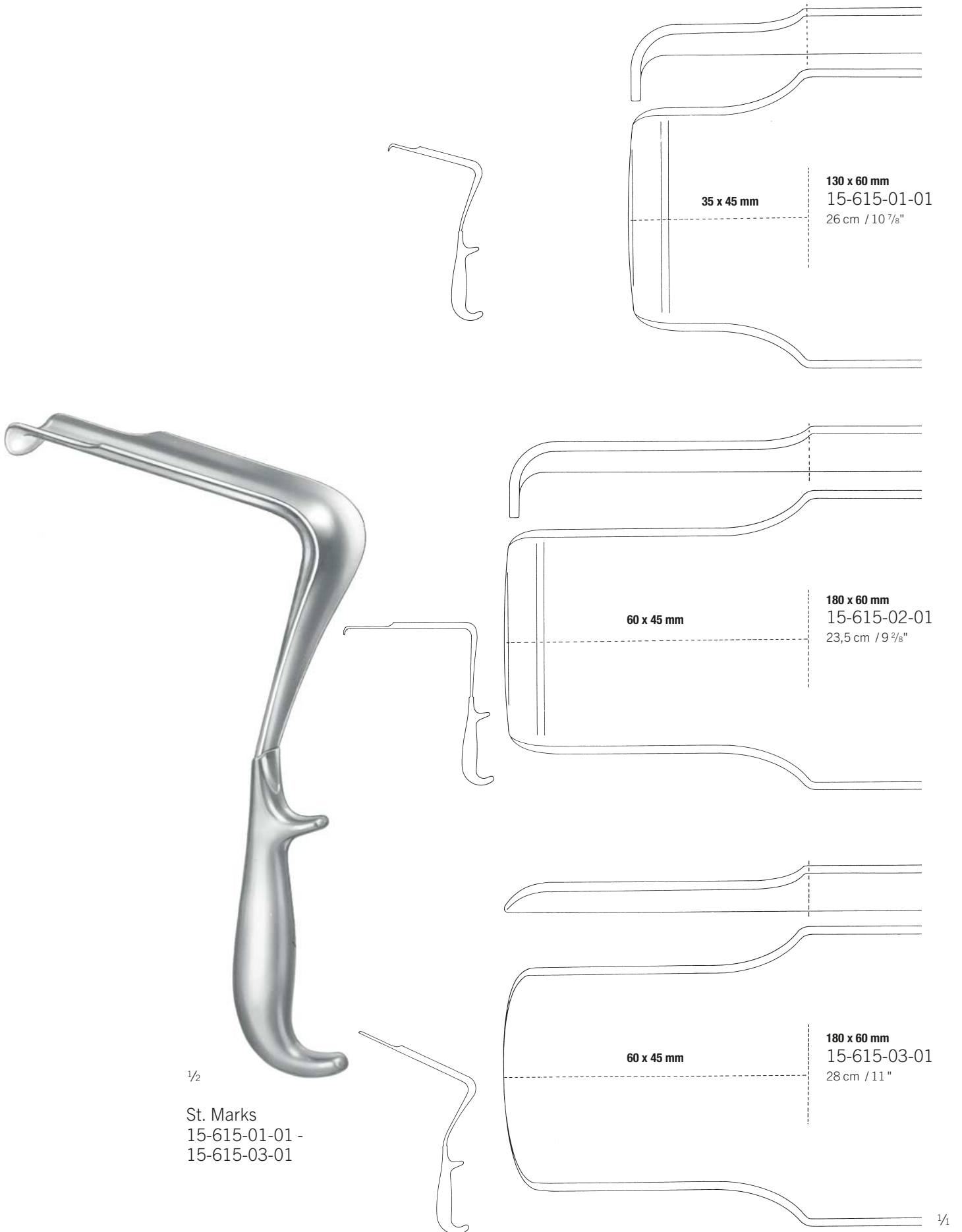
## Pelvishaken

Pelvis Retractors

Separadores para pelvis

Ecarteurs pour pelvis

Divaricatori per pelvis





## Bauchspatel

Abdominal Spatulas  
Espátulas abdominales  
Spatules abdominales  
Spatole addominali

## Wundhaken

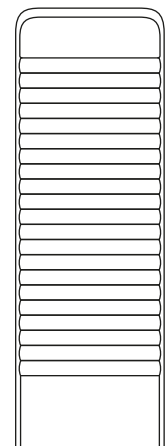
Retractors  
Separadores  
Ecarteurs  
Divaricatori



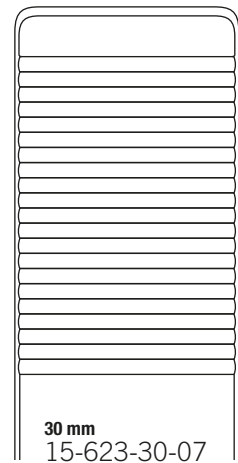
Kümmel  
15-621-28-07  
31 cm / 12 3/8"



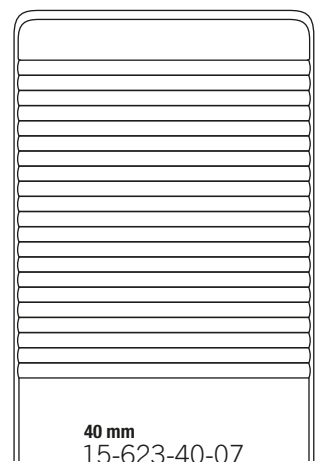
Kader  
15-623-20-07 -  
15-623-40-07  
28 cm / 11"



20 mm  
15-623-20-07



30 mm  
15-623-30-07



40 mm  
15-623-40-07

15

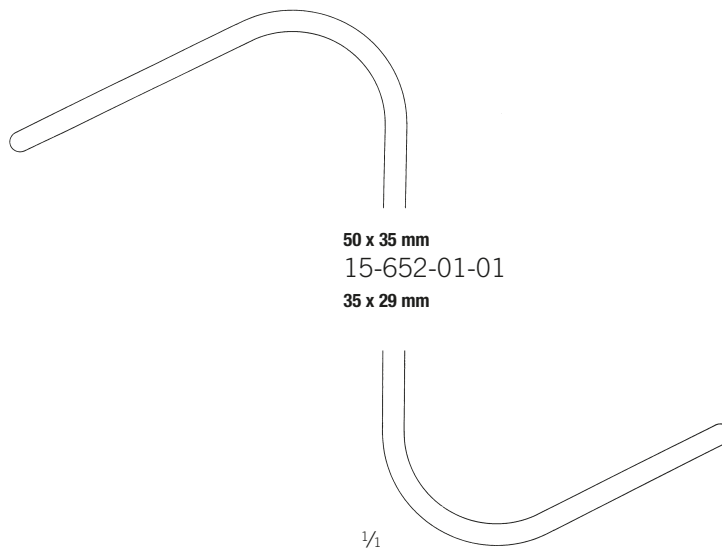
# Wundhaken

Retractors  
Separadores  
Ecarteurs  
Divaricatori



1/2

Collin-Hartmann  
15-652-01-01  
15 cm / 5 7/8"



50 x 35 mm  
15-652-01-01  
35 x 29 mm

1/1



1/2

Roux  
15-655-00-01 -  
15-655-03-01

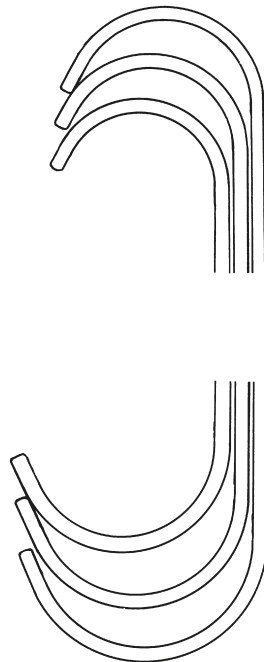


Fig. 1  
22 x 21 mm  
27 x 29 mm  
15-655-01-01  
14,5 cm / 5 9/8"

Fig. 2  
25 x 26 mm  
30 x 38 mm  
15-655-02-01  
16 cm / 6 2/8"

Fig. 3  
28 x 29 mm  
33 x 43 mm  
15-655-03-01  
17 cm / 6 6/8"

1/1

Fig. 1 - 3  
15-655-00-01  
17 cm / 6 5/8"  
Satz  
Set

## Wundhaken

Retractors  
Separadores  
Ecarteurs  
Divaricatori

## Wundhaken

Retractors  
Separadores  
Ecarteurs  
Divaricatori

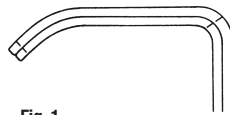


Fig. 1  
26 x 10 mm / 30 x 13 mm

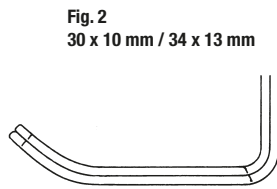


Fig. 2  
30 x 10 mm / 34 x 13 mm

1/2

1/1

Farabeuf  
15-663-00-07  
12 cm / 4 5/8"

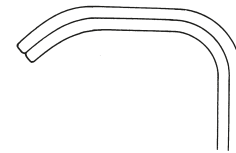


Fig. 1  
23 x 16 mm / 26 x 16 mm

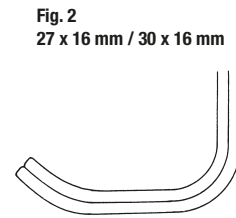


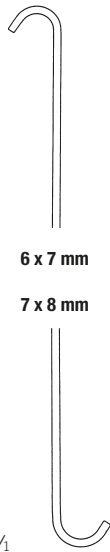
Fig. 2  
27 x 16 mm / 30 x 16 mm

1/2

1/1

Farabeuf  
15-665-00-07  
15,5 cm / 6 1/8"

15



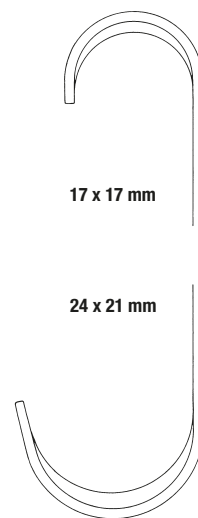
6 x 7 mm

7 x 8 mm

1/2

1/1

Roux-Mini  
15-667-06-01  
14,5 cm / 5 5/8"



17 x 17 mm

24 x 21 mm

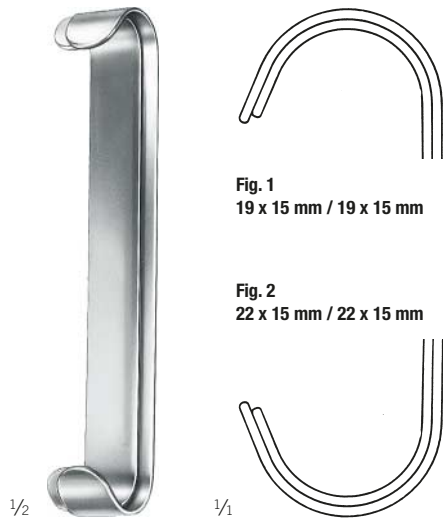
1/2

1/1

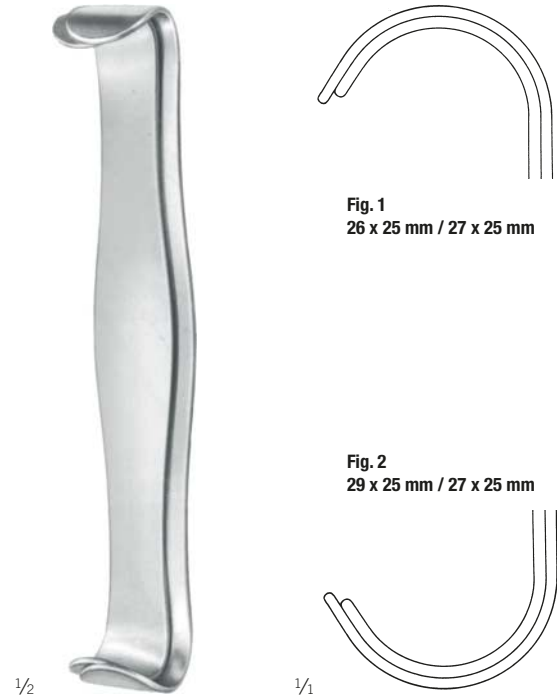
Roux-Baby  
15-669-13-01  
12,5 cm / 4 7/8"

# Wundhaken

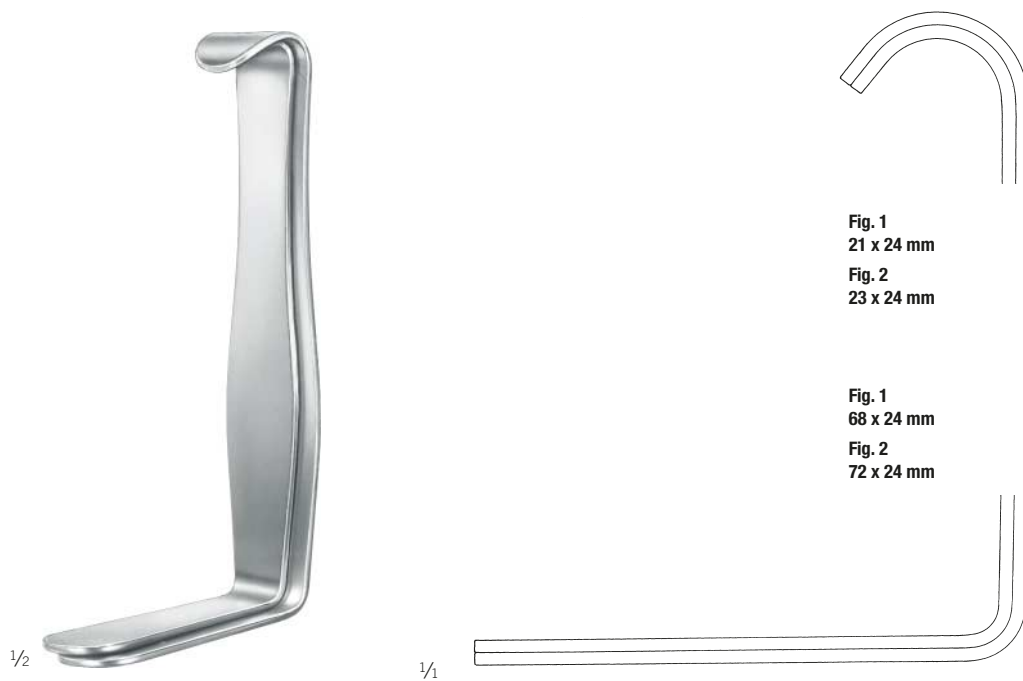
Retractors  
Separadores  
Ecarteurs  
Divaricatori



Parker  
15-673-01-07  
14 cm / 5 4/8"



Parker  
15-673-02-07  
18,5 cm / 7 2/8"



Parker-Mott  
15-675-00-07  
16 cm / 6 2/8"

## Wundhaken

Retractors  
Separadores  
Ecarteurs  
Divaricatori

## Wundhaken

Retractors  
Separadores  
Ecarteurs  
Divaricatori



1/2

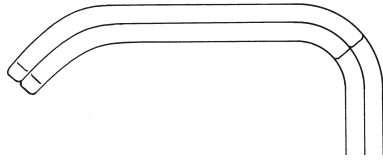
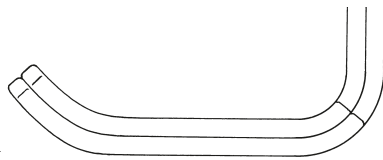


Fig. 1  
42 x 13 mm / 42 x 26 mm



1/1

Fig. 2  
47 x 13 mm / 46 x 26 mm

Mathieu  
15-683-00-07  
20 cm / 7 7/8"



1/2

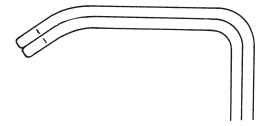
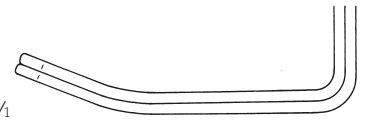


Fig. 1  
21 x 15 mm / 40 x 15 mm



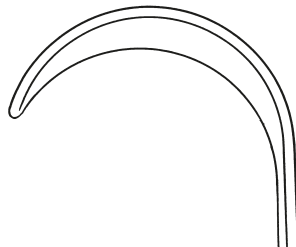
1/1

Fig. 2  
25 x 15 mm / 45 x 15 mm

Parker-Langenbeck  
15-687-00-07  
21,5 cm / 8 4/8"

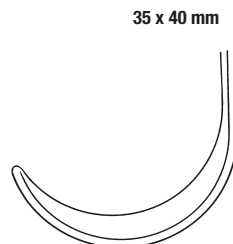


1/2



26 x 30 mm

1/1



35 x 40 mm

Goelet  
15-695-00-01  
19 cm / 7 4/8"

15

## Wundspreizer, selbsthaltend

Wound Spreaders, self-retaining

Separadores autoestáticos

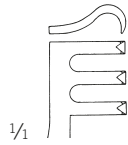
Ecarteurs autostatiques

Divaricatori autostatici



1/2

Finsen  
15-700-05-07 -  
15-703-07-07



1/1

15-700-05-07

5 cm / 2"

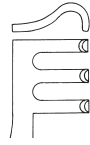
scharf  
sharp  
agudo  
pointu  
acuto



2:3



16 mm



15-701-05-07

5 cm / 2"

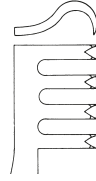
stumpf  
blunt  
romo  
mousse  
smusso



2:3



16 mm



15-702-07-07

7 cm / 2 5/8"

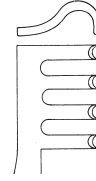
scharf  
sharp  
agudo  
pointu  
acuto



3:4



20 mm



15-703-07-07

7 cm / 2 5/8"

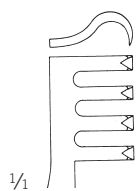
stumpf  
blunt  
romo  
mousse  
smusso



3:4



20 mm



1/1

15-704-07-07

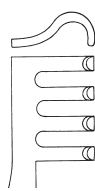
mit Stellschraube, scharf  
with adjusting screw, sharp  
con tornillo de ajuste, agudo  
avec vis d'ajustage, pointu  
con vite di arresto, acuto



3:4



30 mm



15-705-07-07

mit Stellschraube, stumpf  
with adjusting screw, blunt  
con tornillo de ajuste, romo  
avec vis d'ajustage, mousse  
con vite di arresto, smusso



3:4



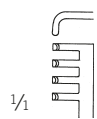
30 mm



1/2

15-717-10-07

10 cm / 3 7/8"



1/1

stumpf  
blunt  
romo  
mousse  
smusso



4:4



24 mm

1/2

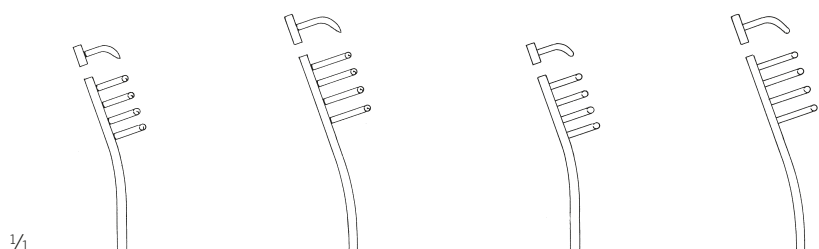
Finsen-Martin  
15-704-07-07 -  
15-705-07-07  
7,5 cm / 3"

## Wundspreizer, selbsthaltend

Wound Spreaders, self-retaining  
 Separadores autoestáticos  
 Ecarteurs autostatiques  
 Divaricatori autostatici

## Wundhaken

Retractors  
 Separadores  
 Ecarteurs  
 Divaricatori



1/1

15-714-07-07

7 cm / 2 6/8"

scharf  
 sharp  
 agudo  
 pointu  
 acuto



4:4



55 mm

15-714-10-07

10 cm / 3 7/8"

scharf  
 sharp  
 agudo  
 pointu  
 acuto



4:4



70 mm

15-715-07-07

7 cm / 2 6/8"

stumpf  
 blunt  
 romo  
 mousse  
 smusso



4:4



55 mm

15-715-10-07

10 cm / 3 7/8"

stumpf  
 blunt  
 romo  
 mousse  
 smusso



4:4



70 mm

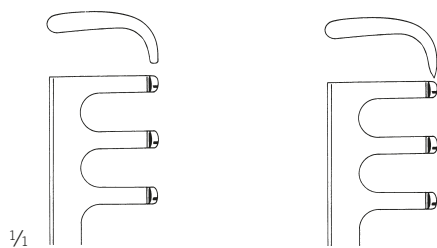


1/2

Alm

15-714-07-07 -  
 15-715-10-07

mit Stellschraube  
 with adjusting screw  
 con tornillo de ajuste  
 avec vis d'ajustage  
 con vite di arresto



1/1

15-723-10-07

mit Stellschraube, stumpf  
 with adjusting screw, blunt  
 con tornillo de ajuste, romo  
 avec vis d'ajustage, mousse  
 con vite di arresto, smusso



3:3



47 mm

15-723-20-07

mit Stellschraube, scharf  
 with adjusting screw, sharp  
 con tornillo de ajuste, agudo  
 avec vis d'ajustage, pointu  
 con vite di arresto, acuto



3:3



47 mm



1/2

Jansen

15-723-10-07-  
 15-723-20-07

10 cm / 3 7/8"

15

## Wundspreizer, selbsthaltend

Wound Spreaders, self-retaining

Separadores autoestáticos

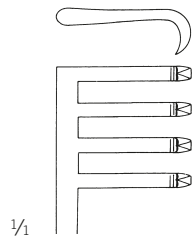
Ecarteurs autostatiques

Divaricatori autostatici



1/2

Scalp-Contour  
15-725-14-07 -  
15-727-14-07  
13,5 cm / 5 3/8"



1/4

15-725-14-07

13,5 cm / 5 3/8"

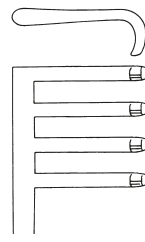
scharf  
sharp  
agudo  
pointu  
acuto



3:4



55 mm



15-727-14-07

13,5 cm / 5 3/8"

stumpf  
blunt  
romo  
mousse  
smusso



3:4

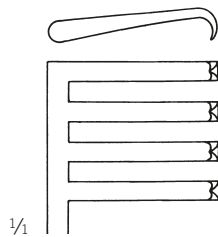


55 mm



1/2

Anderson-Adson  
15-732-20-07  
19 cm / 7 1/8"



1/4

scharf  
sharp  
agudo  
pointu  
acuto



4:4



84 mm



## Wundspreizer, selbsthaltend

Wound Spreaders, self-retaining

Separadores autoestáticos

Ecarteurs autostatiques

Divaricatori autostatici

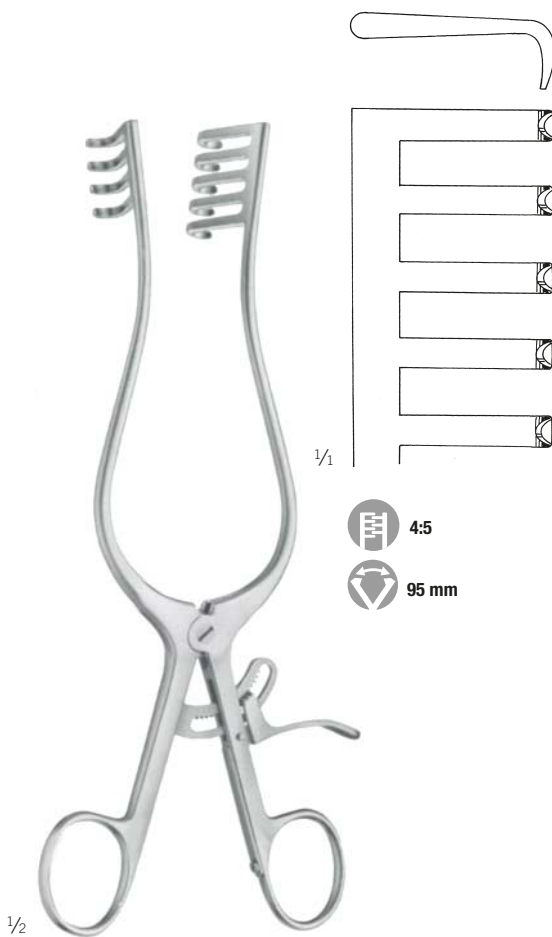
## Wundhaken

Retractors

Separadores

Ecarteurs

Divaricatori



1/1



4:5



95 mm

1/2

Travers  
15-733-21-07

21,5 cm / 8 4/8"

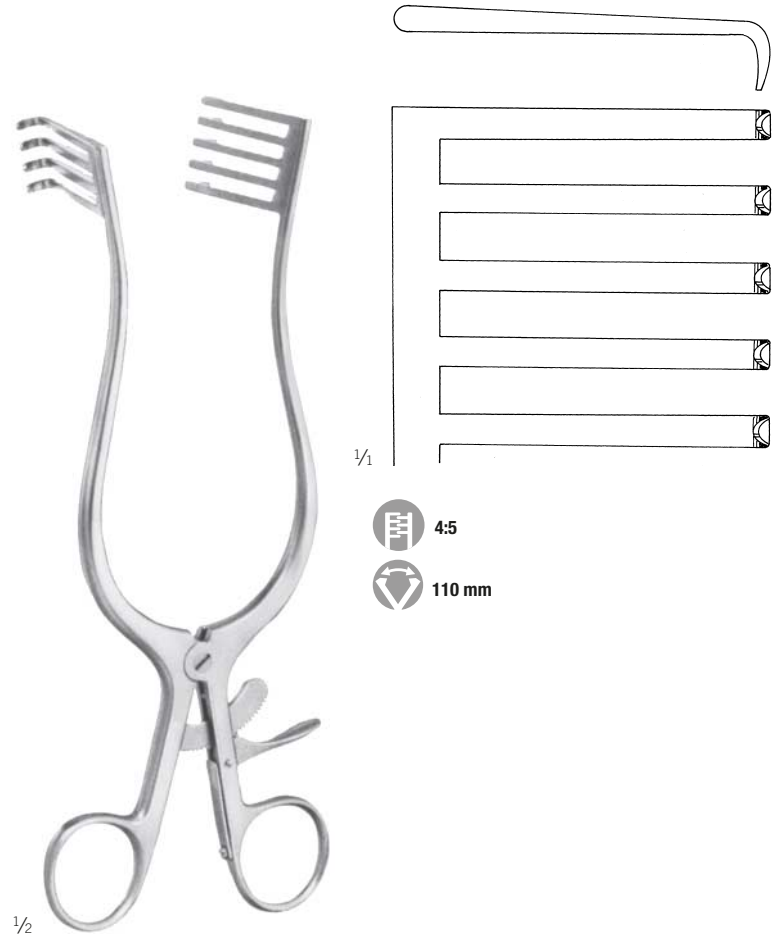
stumpf

blunt

romo

mousse

smusso



1/1



4:5



110 mm

1/2

Norfolk-Norwich  
15-733-22-07

22 cm / 8 5/8"

stumpf

blunt

romo

mousse

smusso

## Wundspreizer, selbsthaltend

Wound Spreaders, self-retaining

Separadores autoestáticos

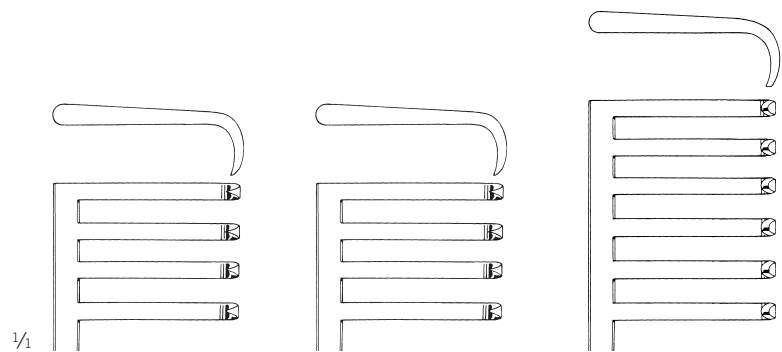
Ecarteurs autostatiques

Divaricatori autostatici

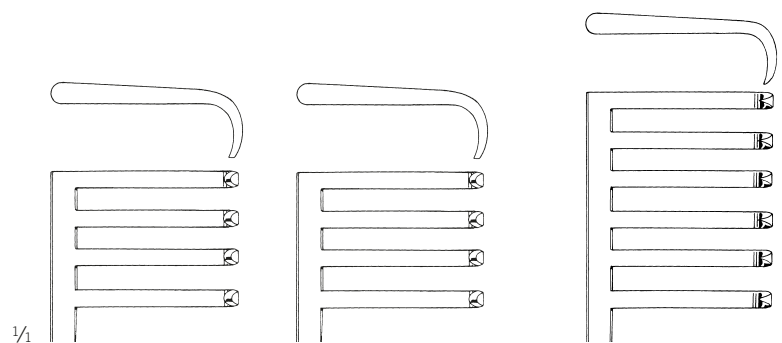


1/2

Weitlaner  
15-734-20-07 -  
15-735-26-07



|   |                |                |               |
|---|----------------|----------------|---------------|
| scharf<br>sharp<br>agudo<br>pointu<br>acuto | 15-734-20-07   | 15-734-24-07   | 15-734-26-07  |
|   | 20 cm / 7 7/8" | 24 cm / 9 4/8" | 25,5 cm / 10" |
|   | 3:4            | 3:4            | 5:6           |
|   | 90 mm          | 90 mm          | 90 mm         |



|   |                |                |               |
|---|----------------|----------------|---------------|
| stumpf<br>blunt<br>romo<br>mousse<br>smusso | 15-735-20-07   | 15-735-24-07   | 15-735-26-07  |
|   | 20 cm / 7 7/8" | 24 cm / 9 4/8" | 25,5 cm / 10" |
|   | 3:4            | 3:4            | 5:6           |
|   | 90 mm          | 90 mm          | 90 mm         |

## Wundspreizer, selbsthaltend

Wound Spreaders, self-retaining

Separadores autoestáticos

Ecarteurs autostatiques

Divaricatori autostatici

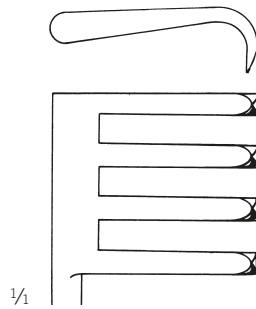
## Wundhaken

Retractors

Separadores

Ecarteurs

Divaricatori



1/4

15-736-26-07

26 cm / 10 2/8"

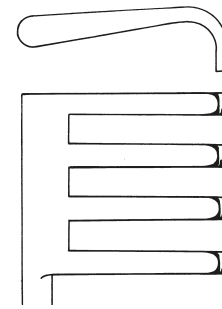
scharf

sharp

agudo

pointu

acuto



15-737-26-07

26 cm / 10 2/8"

stumpf

blunt

romo

mousse

smusso

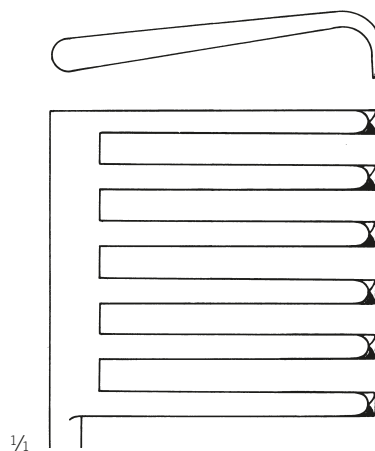


1/2

Adson

15-736-26-07 -

15-739-26-07



1/4

15-738-26-07

29 cm / 11 3/8"

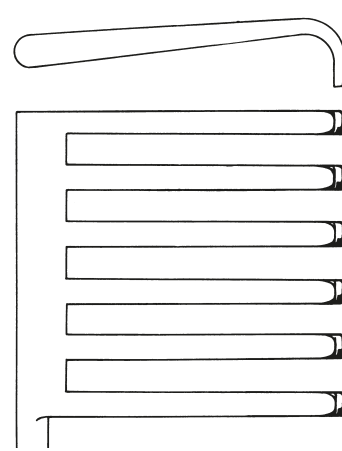
scharf

sharp

agudo

pointu

acuto



15-739-26-07

29 cm / 11 3/8"

stumpf

blunt

romo

mousse

smusso



15

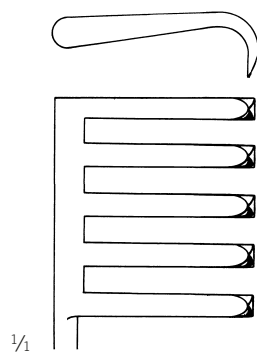
## Wundspreizer, selbsthaltend

Wound Spreaders, self-retaining

Separadores autoestáticos

Ecarteurs autostatiques

Divaricatori autostatici



15-738-25-07

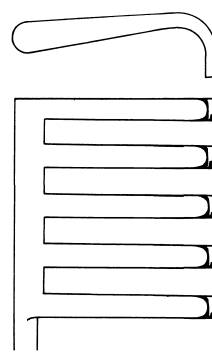
scharf  
sharp  
agudo  
pointu  
acuto



5:6



110 mm



15-739-25-07

stumpf  
blunt  
romo  
mousse  
smusso



5:6



110 mm

15-738-25-07 -  
15-739-25-07  
25,5 cm / 10"

## Wundspreizer, selbsthaltend

Wound Spreaders, self-retaining

Separadores autoestáticos

Ecarteurs autostatiques

Divaricatori autostatici

## Wundhaken

Retractors

Separadores

Ecarteurs

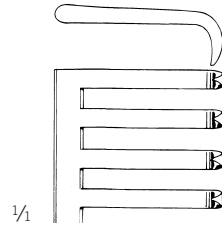
Divaricatori



1/2

15-740-13-07 -  
15-741-13-07

13,5 cm / 5 3/8"



1/4

15-740-13-07

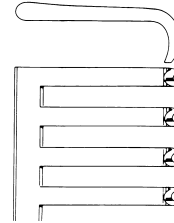
scharf  
sharp  
agudo  
pointu  
acuto



3:4



43 mm



15-741-13-07

stumpf  
blunt  
romo  
mousse  
smusso



3:4



43 mm

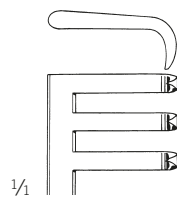
15



1/2

Weitlaner  
15-748-10-07 -  
15-749-10-07

11 cm / 4 3/8"



1/4

15-748-10-07

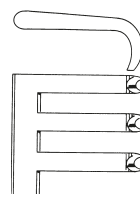
scharf  
sharp  
agudo  
pointu  
acuto



2:3



40 mm



15-749-10-07

stumpf  
blunt  
romo  
mousse  
smusso



2:3



40 mm

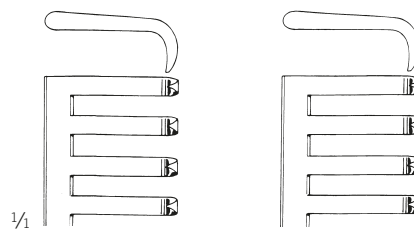
## Wundspreizer, selbsthaltend

Wound Spreaders, self-retaining

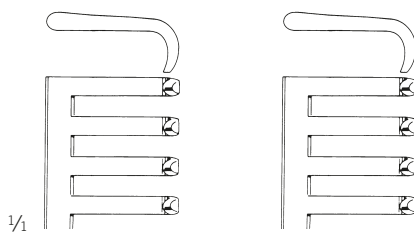
Separadores autoestáticos

Ecarteurs autostatiques

Divaricatori autostatici



|   |  |   |   |
|---|--|---|---|
| scharf<br>sharp<br>agudo<br>pointu<br>acuto |  | 15-750-13-07                              | 15-750-16-07                            |
|   |  | 13,5 cm / 5 <sup>3</sup> / <sub>8</sub> " | 16 cm / 6 <sup>2</sup> / <sub>8</sub> " |
|   |  | <b>43 mm</b>                              | <b>83 mm</b>                            |
|   |  | <b>3:4</b>                                | <b>3:4</b>                              |



|   |  |   |   |
|---|--|---|---|
| stumpf<br>blunt<br>romo<br>mousse<br>smusso |  | 15-751-13-07                              | 15-751-16-07                            |
|   |  | 13,5 cm / 5 <sup>3</sup> / <sub>8</sub> " | 16 cm / 6 <sup>2</sup> / <sub>8</sub> " |
|   |  | <b>43 mm</b>                              | <b>83 mm</b>                            |
|   |  | <b>3:4</b>                                | <b>3:4</b>                              |



Weitlaner  
15-750-13-07 -  
15-751-16-07

## Wundspreizer, selbsthaltend

Wound Spreaders, self-retaining

Separadores autoestáticos

Ecarteurs autostatiques

Divaricatori autostatici

## Wundhaken

Retractors

Separadores

Ecarteurs

Divaricatori



1/2

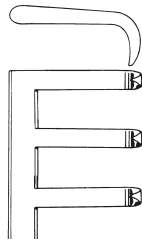
Weitlaner-Wullstein

15-752-13-07 -

15-753-13-07

13 cm / 5 1/8"

1/1



15-752-13-07

scharf

sharp

agudo

pointu

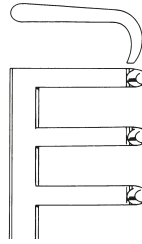
acuto



3:3



40 mm



15-753-13-07

stumpf

blunt

romo

mousse

smusso



3:3



40 mm



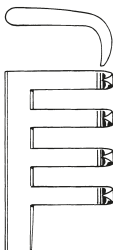
1/2

Mollison

15-754-15-07

15,5 cm / 6 1/8"

1/1



scharf

sharp

agudo

pointu

acuto



4:4



80 mm

## Wundspreizer, selbsthaltend

Wound Spreaders, self-retaining

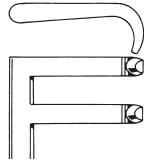
Separadores autoestáticos

Ecarteurs autostatiques

Divaricatori autostatici



1/1



15-755-13-07

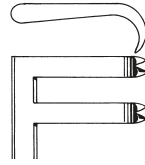
stumpf  
blunt  
romo  
mousse  
smusso



2:2



37 mm



15-756-13-07

scharf  
sharp  
agudo  
pointu  
acuto



2:2



37 mm

1/2

Plester

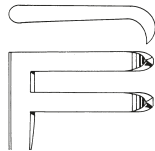
15-755-13-07 -

15-756-13-07

13 cm / 5 1/8"



1/1



1/2

Plester

15-757-11-07

10,5 cm / 4 1/8"

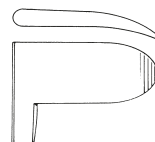
stumpf  
blunt  
romo  
mousse  
smusso



37 mm



1/1



1/2

Plester

15-759-11-07

10,5 cm / 4 1/8"

stumpf  
blunt  
romo  
mousse  
smusso



37 mm

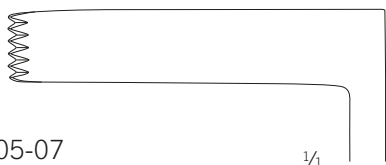


## Wundspreizer, selbsthaltend

Wound Spreaders, self-retaining  
Separadores autoestáticos  
Ecarteurs autostatiques  
Divaricatori autostatici

## Wundhaken

Retractors  
Separadores  
Ecarteurs  
Divaricatori

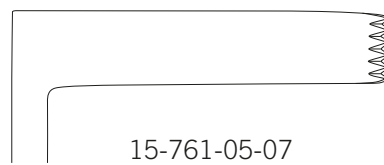


15-762-05-07

1/1

**50 x 10 mm**

Valve links voll  
Blade left full  
Valva a la izquierda plena  
Valve sur le bras à gauche  
Valva sul braccio sinistro

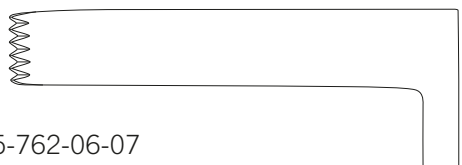


1/1

15-761-05-07

**50 x 10 mm**

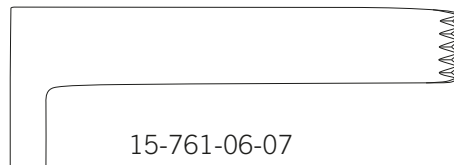
Valve rechts voll  
Blade rightfull  
Valva a la derecha plena  
Valve sur le bras à droite  
Valva sul braccio destro



15-762-06-07

**60 x 10 mm**

Valve links voll  
Blade left full  
Valva a la izquierda plena  
Valve sur le bras à gauche  
Valva sul braccio sinistro



15-761-06-07

**60 x 10 mm**

Valve rechts voll  
Blade rightfull  
Valva a la derecha plena  
Valve sur le bras à droite  
Valva sul braccio destro



15-762-07-07

**70 x 10 mm**

Valve links voll  
Blade left full  
Valva a la izquierda plena  
Valve sur le bras à gauche  
Valva sul braccio sinistro



15-761-07-07

**70 x 10 mm**

Valve rechts voll  
Blade rightfull  
Valva a la derecha plena  
Valve sur le bras à droite  
Valva sul braccio destro



1/2

Williams  
15-761-05-07 -  
15-762-07-07  
17 cm / 6 5/8"



102 mm

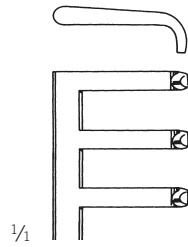
## Wundspreizer, selbsthaltend

Wound Spreaders, self-retaining

Separadores autoestáticos

Ecarteurs autostatiques

Divaricatori autostatici



stumpf  
blunt  
romo  
mousse  
smusso

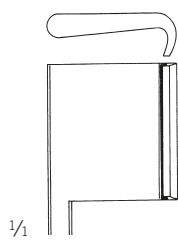
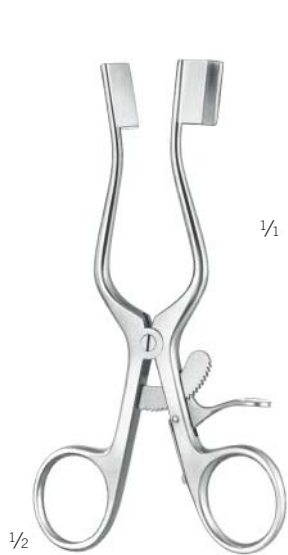


3:3



40 mm

Milligan  
15-765-13-07  
13,5 cm / 5 3/8"



50 mm

Weitlaner-Baby  
15-767-13-07  
13,5 cm / 5 3/8"

## Wundspreizer, selbsthaltend, Mittelvalven

Wound Spreaders, self-retaining, Central Blades

Separadores autoestáticos, valvas centrales

Ecarteurs autostatiques, valves centrales

Divaricatori autostatici, valve centrali

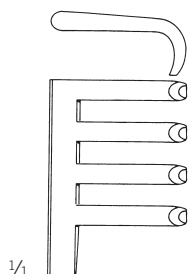
## Wundhaken

Retractors

Separadores

Ecarteurs

Divaricatori

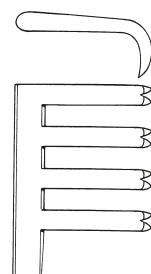


1/1

15-768-00-07



stumpf  
blunt  
romo  
mousse  
smusso



15-769-00-07



scharf  
sharp  
agudo  
pointu  
acuto



1/2

Henley  
15-768-00-07 -  
15-769-00-07  
16,5 cm / 6 4/8"



komplett mit 3 Mittelvalven  
Art.-Nr. 15-768-19-07, 15-768-25-07 und 15-768-32-07

complete with 3 central blades  
ref. 15-768-19-07, 15-768-25-07 and 15-768-32-07

completo con 3 valvas centrales  
ref. 15-768-19-07, 15-768-25-07 y 15-768-32-07

complet avec 3 valves centrales  
réf. 15-768-19-07, 15-768-25-07 et 15-768-32-07

completo con 3 valve centrali  
rif. 15-768-19-07, 15-768-25-07 e 15-768-32-07



1/2

15-768-19-07  
19 x 17 mm



15-768-25-07  
25 x 17 mm



15-768-32-07  
32 x 17 mm

15

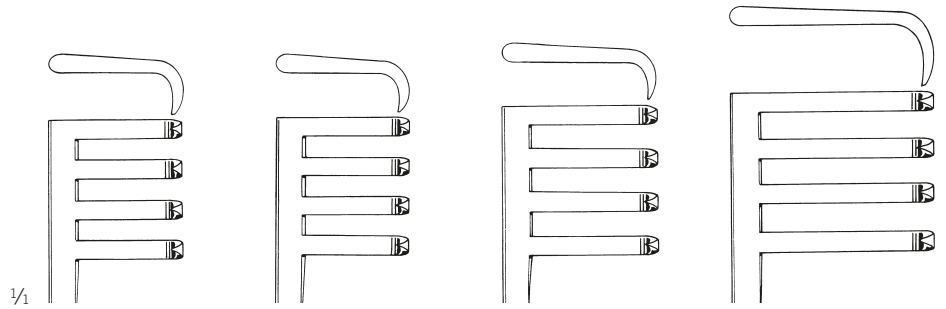
## Wundspreizer, selbsthaltend

Wound Spreaders, self-retaining

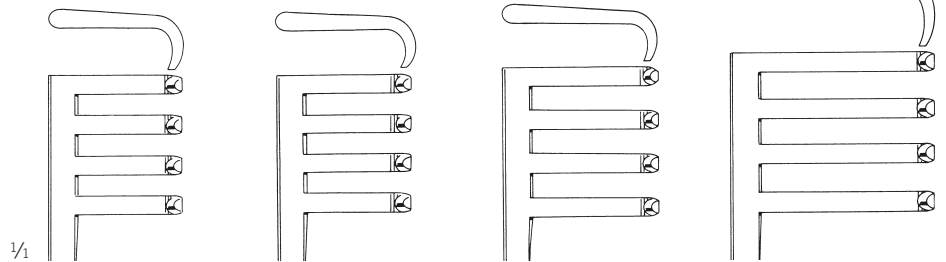
Separadores autoestáticos

Ecarteurs autostatiques

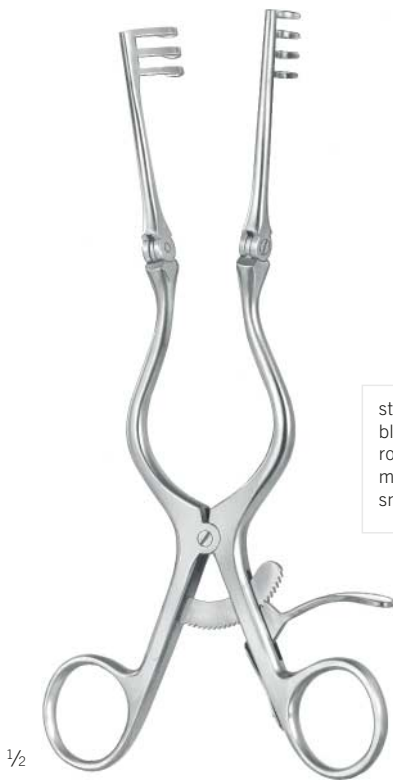
Divaricatori autostatici



|   |  |                |                  |                |                  |
|---|--|----------------|------------------|----------------|------------------|
| scharf<br>sharp<br>agudo<br>pointu<br>acuto |  | 15-770-13-07   | 15-770-16-07     | 15-770-20-07   | 15-770-26-07     |
|   |  | 14 cm / 5 4/8" | 16,5 cm / 6 4/8" | 21 cm / 8 2/8" | 24,5 cm / 9 5/8" |
|   |  | <b>81 mm</b>   | <b>90 mm</b>     | <b>135 mm</b>  | <b>135 mm</b>    |
|   |  | <b>3:4</b>     | <b>3:4</b>       | <b>3:4</b>     | <b>3:4</b>       |



|   |  |                |                  |                |                  |
|---|--|----------------|------------------|----------------|------------------|
| stumpf<br>blunt<br>romo<br>mousse<br>smusso |  | 15-771-13-07   | 15-771-16-07     | 15-771-20-07   | 15-771-26-07     |
|   |  | 14 cm / 5 4/8" | 16,5 cm / 6 4/8" | 21 cm / 8 2/8" | 24,5 cm / 9 5/8" |
|   |  | <b>81 mm</b>   | <b>90 mm</b>     | <b>135 mm</b>  | <b>135 mm</b>    |
|   |  | <b>3:4</b>     | <b>3:4</b>       | <b>3:4</b>     | <b>3:4</b>       |



Adson  
15-770-13-07 -  
15-771-26-07

## Wundspreizer, selbsthaltend

Wound Spreaders, self-retaining

Separadores autoestáticos

Ecarteurs autostatiques

Divaricatori autostatici

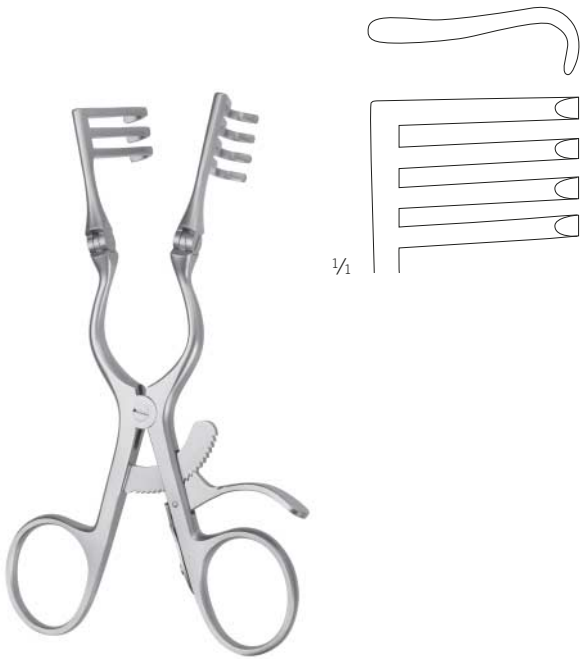
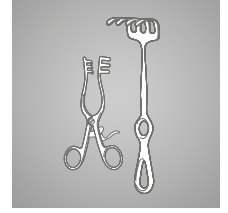
## Wundhaken

Retractors

Separadores

Ecarteurs

Divaricatori



1/2

1/1

Adson  
15-773-13-07

14 cm / 5 1/8"

stumpf  
blunt  
romo  
mousse  
smusso



3:4



60 mm

## Wundspreizer, selbsthaltend, Valven

Wound Spreaders, self-retaining, Blades

Separadores autoestáticos, valvas

Ecarteurs autostatiques, valves

Divaricatori autostatici, valve



1/2

Cloward  
15-774-00-07



149 mm

komplett mit je 2 Steckvalven  
Art.-Nr. 15-774-40-07 - 15-774-60-07

with 2 each plug-in blades  
ref. 15-774-40-07 - 15-774-60-07

con 2 valvas enchufables de c.u.  
ref. 15-774-40-07 - 15-774-60-07

chacun avec 2 valves interchangeables  
réf. 15-774-40-07 - 15-774-60-07

con 2 valve ad innesto  
rif. 15-774-40-07 - 15-774-60-07

1/2



15-774-40-07  
4 cm / 1 5/8"



15-774-00-07 & 15-774-25-07,  
15-775-00-07 & 15-775-15-07

gezahnt, Paar  
toothed, pair  
dentado, par  
dentelé, paire  
dentato, paio



15-774-45-07  
4,5 cm / 1 9/16"



15-774-00-07 & 15-774-25-07,  
15-775-00-07 & 15-775-15-07

gezahnt, Paar  
toothed, pair  
dentado, par  
dentelé, paire  
dentato, paio



15-774-50-07  
5 cm / 2"



15-774-00-07 & 15-774-25-07,  
15-775-00-07 & 15-775-15-07

gezahnt, Paar  
toothed, pair  
dentado, par  
dentelé, paire  
dentato, paio



15-774-55-07  
5,5 cm / 2 1/8"



15-774-00-07 & 15-774-25-07,  
15-775-00-07 & 15-775-15-07

gezahnt, Paar  
toothed, pair  
dentado, par  
dentelé, paire  
dentato, paio



15-774-60-07  
6 cm / 2 3/8"



15-774-00-07 & 15-774-25-07,  
15-775-00-07 & 15-775-15-07

gezahnt, Paar  
toothed, pair  
dentado, par  
dentelé, paire  
dentato, paio

15-774-25-07  
25 cm / 9 7/8"

Sperrer allein  
Spreader only  
Separador suelto  
Ecarteur seul  
Divaricatore solo

## Wundspreizer, selbsthaltend, Valven

Wound Spreaders, self-retaining, Blades

Separadores autoestáticos, valvas

Ecarteurs autostatiques, valves

Divaricatori autostatici, valve

## Wundhaken

Retractors

Separadores

Ecarteurs

Divaricatori



15-775-40-07

4 cm / 1 5/8"



15-775-00-07 & 15-775-15-07,  
15-774-00-07 & 15-774-25-07

glatt, Paar  
smooth, pair  
lisa, par  
lisse, paire  
liscio, paio



15-775-45-07

4,5 cm / 1 6/8"



15-775-00-07 & 15-775-15-07,  
15-774-00-07 & 15-774-25-07

glatt, Paar  
smooth, pair  
lisa, par  
lisse, paire  
liscio, paio



15-775-50-07

5 cm / 2"



15-775-00-07 & 15-775-15-07,  
15-774-00-07 & 15-774-25-07

glatt, Paar  
smooth, pair  
lisa, par  
lisse, paire  
liscio, paio



15-775-55-07

5,5 cm / 2 1/8"



15-775-00-07 & 15-775-15-07,  
15-774-00-07 & 15-774-25-07

glatt, Paar  
smooth, pair  
lisa, par  
lisse, paire  
liscio, paio



15-775-60-07

6 cm / 2 3/8"



15-775-00-07 & 15-775-15-07,  
15-774-00-07 & 15-774-25-07

glatt, Paar  
smooth, pair  
lisa, par  
lisse, paire  
liscio, paio



1/2

Cloward

15-775-00-07



58 mm

komplett mit je 2 Steckvalven  
Art.-Nr. 15-775-40-07 - 15-775-60-07

with 2 each plug-in blades  
ref. 15-775-40-07 - 15-775-60-07

con 2 valvas enchufables de c.u.  
ref. 15-775-40-07 - 15-775-60-07

chacun avec 2 valves interchangeableables  
réf. 15-775-40-07 - 15-775-60-07

con 2 valve ad innesto  
rif. 15-775-40-07 - 15-775-60-07

15-775-15-07

15 cm / 5 7/8"

Sperrer allein  
Spreader only  
Separador solo  
Ecarteur seul  
Divaricatore solo

## Wundspreizer, selbsthaltend

Wound Spreaders, self-retaining

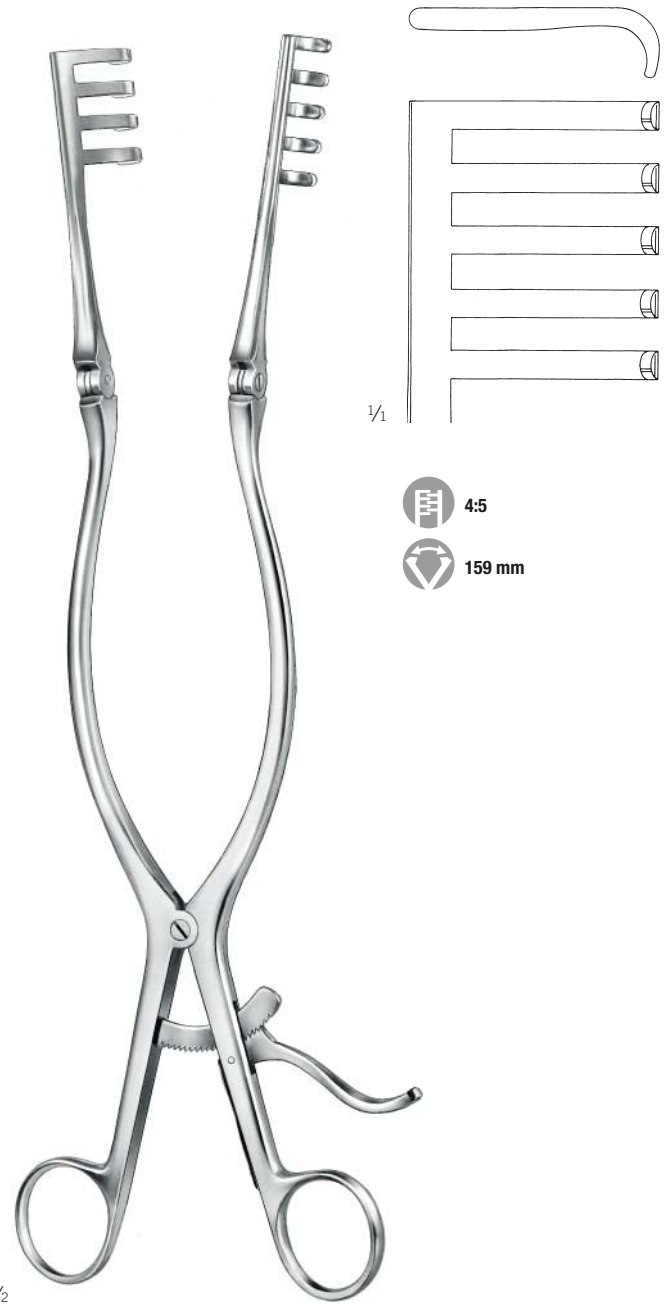
Separadores autoestáticos

Ecarteurs autostatiques

Divaricatori autostatici



Beckmann  
15-776-31-07  
32 cm / 12 5/8"  
scharf  
sharp  
agudo  
pointu  
acuto



Adson  
15-777-32-07  
33 cm / 13"  
stumpf  
blunt  
romo  
mousse  
smusso



## Wundspreizer, selbsthaltend

Wound Spreaders, self-retaining

Separadores autoestáticos

Ecarteurs autostatiques

Divaricatori autostatici

## Wundhaken

Retractors

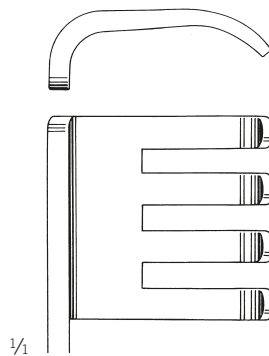
Separadores

Ecarteurs

Divaricatori



1/2

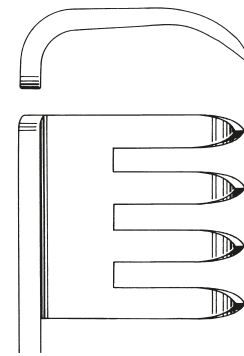


1/1

15-778-00-07

31 cm / 12 2/8"

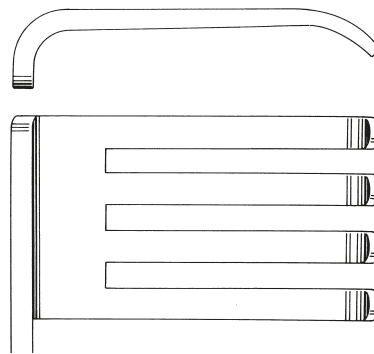
stumpf  
blunt  
romo  
mousse  
smusso



15-778-01-07

31 cm / 12 2/8"

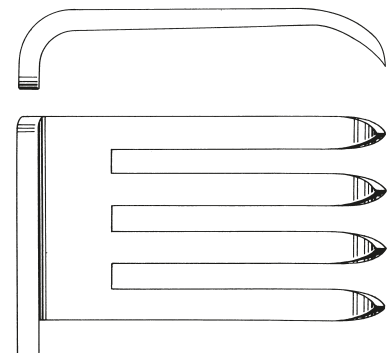
scharf  
sharp  
agudo  
pointu  
acuto



15-778-02-07

30,5 cm / 12 "

stumpf  
blunt  
romo  
mousse  
smusso



15-778-03-07

30,5 cm / 12 "

scharf  
sharp  
agudo  
pointu  
acuto



Beckman-Adson  
15-778-00-07 -  
15-778-03-07



142 mm

15

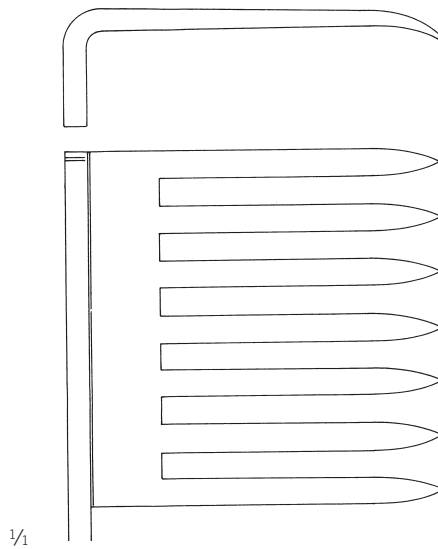
## Wundspreizer, selbsthaltend

Wound Spreaders, self-retaining

Separadores autoestáticos

Ecarteurs autostatiques

Divaricatori autostatici



7.7



159 mm

Beckman-Eaton

15-778-32-07

32 cm / 12 5/8"

scharf  
sharp  
agudo  
pointu  
acuto

## Wundspreizer, selbsthaltend

Wound Spreaders, self-retaining

Separadores autoestáticos

Ecarteurs autostatiques

Divaricatori autostatici

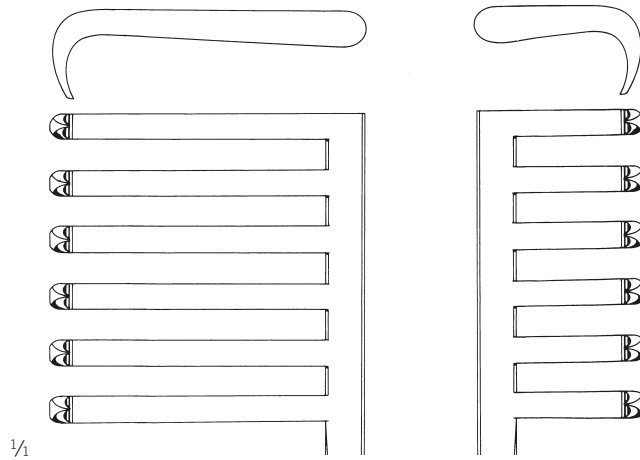
## Wundhaken

Retractors

Separadores

Ecarteurs

Divaricatori



1/4

15-790-01-07

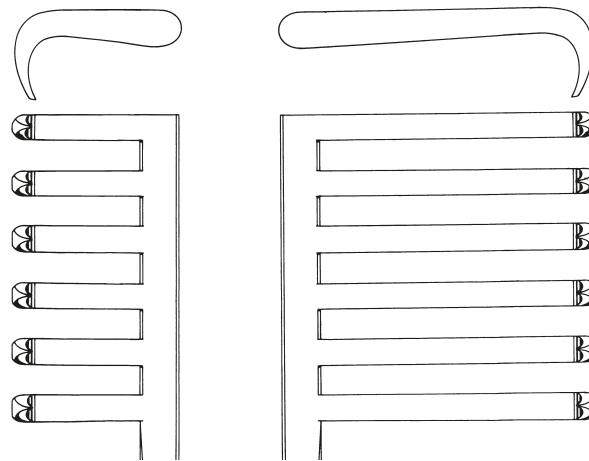
scharf, lange Zähne links  
sharp, long teeth on left side  
agudo, garfios largos a la izquierda  
pointu, griffes longues à gauche  
acuto, denti lunghi a sinistra



6:6



145 mm



15-790-02-07

scharf, lange Zähne rechts  
sharp, long teeth on right side  
agudo, garfios largos a la derecha  
pointu, griffes longues à droite  
acuto, denti lunghi a destra



6:6



145 mm



1/2

Martin  
15-790-01-07 -  
15-790-02-07  
28,5 cm / 11 2/8"

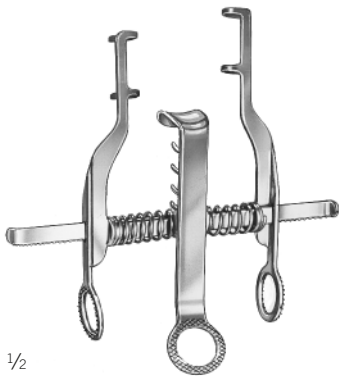
## Wundspreizer, selbsthaltend

Wound Spreaders, self-retaining

Separadores autoestáticos

Ecarteurs autostatiques

Divaricatori autostatici



1/2

### Low-Profile 15-792-00-01

6 cm / 2 3/8"

komplett, mit Mittelvalve Art.-Nr.  
complete, with central blade ref.  
completo, con valva central ref.  
complet, avec valve centrale réf.  
completo, con valva centrale rif.

**15-792-01-01**

stumpf  
blunt  
romo  
mousse  
smusso



2:2



25 mm



1/2

### Low-Profile 15-793-00-01

9 cm / 3 4/8"

komplett, mit Mittelvalve Art.-Nr.  
complete, with central blade ref.  
completo, con valva central ref.  
complet, avec valve centrale réf.  
completo, con valva centrale rif.

**15-792-01-01**

stumpf  
blunt  
romo  
mousse  
smusso



3:3



30 mm



1/2

### Low-Profile 15-794-00-01

7,5 cm / 3"

komplett, mit Mittelvalve Art.-Nr.  
complete, with central blade ref.  
completo, con valva central ref.  
complet, avec valve centrale réf.  
completo, con valva centrale rif.

**15-792-01-01**



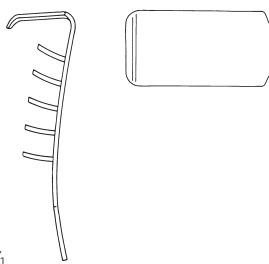
25 mm

### 15-794-90-98

Feder  
Spring  
Pluma  
Plume  
Piuma



**15-794-00-01**



1/1

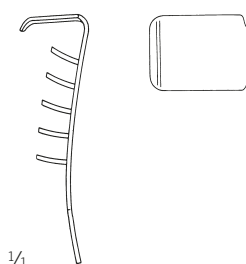
### 15-792-01-01

Mittelvalven  
Central Blades  
Valvas centrales  
Valves centrales  
Valve centrali

**10 x 18 mm**



**15-792-00-01,  
15-793-00-01,  
15-794-00-01,**



1/1

### 15-792-02-01

Mittelvalven  
Central Blades  
Valvas centrales  
Valves centrales  
Valve centrali

**10 x 12 mm**



**15-792-00-01,  
15-793-00-01,  
15-794-00-01,**



1/1

### 15-798-01-01

5 cm / 3"

stumpf, Ringmodell, für Daumen und Finger  
blunt, ring model, for thumb and fingers  
romo, forma de anillo, para pulgar y dedos  
mousse, modèle anneau, pour pouce et doigts  
smusso, modello anulare, per pollice e le dita

## Wundspreizer, selbsthaltend

Wound Spreaders, self-retaining

Separadores autoestáticos

Ecarteurs autostatiques

Divaricatori autostatici

## Wundhaken

Retractors

Separadores

Ecarteurs

Divaricatori



Joll  
15-801-00-07

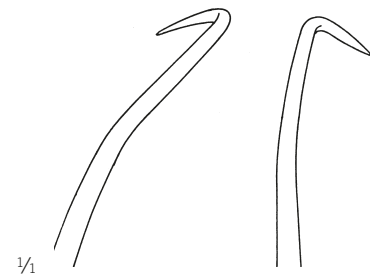
15,5 cm / 6 1/8"

Thyreoid- und Vulva-Spreizer  
Thyroid and Vaginal retractor  
Separador para tiroides y vagina  
Ecarteur pour thyroïde et vulva  
Divaricatore per tiroide e vagina



Gelpi  
15-802-13-07

13 cm / 5 1/8"



1:1

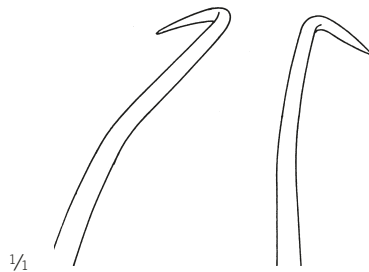
78 mm

15



Gelpi  
15-802-18-07

18 cm / 7 1/8"



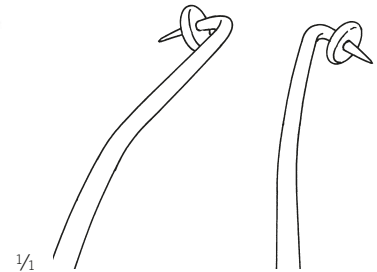
1:1

103 mm



Gelpi  
15-804-18-07

18,5 cm / 7 3/8"



1:1

103 mm

## Bauchdeckenhalter

Abdominal Retractors  
Separadores abdominales  
Ecarteurs abdominaux  
Divaricatori addominali

Gesamtlänge Bauchdeckenhalter ohne Valve  
Total length of abdominal retractor without blade  
Longitud total separador abdominal sin valva  
Longueur totale écarteur abdominal sans valve  
Lunghezza totale divaricatore addominale senza valva



1/2

### Collin, Baby 15-820-00-07

18 cm / 7 1/8"

komplett, mit 2 Paar Seitenvalven Art.-Nr. 15-839-18-07 (18 x 40 mm) und 15-839-27-07 (27 x 40 mm)

complete, with 2 pairs of lateral blades ref. 15-839-18-07 (18 x 40 mm) and 15-839-27-07 (27 x 40 mm)

completo, con 2 pares de valvas laterales ref. 15-839-18-07 (18 x 40 mm) y 15-839-27-07 (27 x 40 mm)

complet, avec 2 paires de valves latérales réf. 15-839-18-07 (18 x 40 mm) et 15-839-27-07 (27 x 40 mm)

completo, con 2 paia di valve laterali ref. 15-839-18-07 (18 x 40 mm) e 15-839-27-07 (27 x 40 mm)



1/2

### Collin 15-822-22-07

20 cm / 7 7/8"

komplett, mit 1 Paar Seitenvalven Art.-Nr. 15-839-38-07 (38 x 60 mm)

complete, with 1 pair of lateral blades ref. 15-839-38-07 (38 x 60 mm)

completo, con 1 par de valvas laterales ref. 15-839-38-07 (38 x 60 mm)

complet, avec 1 paire de valves latérales réf. 15-839-38-07 (38 x 60 mm)

completo, con 1 paio di valve laterali rif. 15-839-38-07 (38 x 60 mm)



## Bauchdeckenhalter

Abdominal Retractors  
Separadores abdominales  
Ecarteurs abdominaux  
Divaricatori addominali

## Wundhaken

Retractors  
Separadores  
Ecarteurs  
Divaricatori



Gesamtlänge Bauchdeckenhalter ohne Valve  
Total length of abdominal retractor without blade  
Longitud total separador abdominal sin valva  
Longueur totale écarteur abdominal sans valve  
Lunghezza totale divaricatore addominale senza valva



1/2

15-823-90-98

Mittelvalve  
central blad  
valva central  
valve centrale  
valva centrale



15-823-00-07

15-824-90-98

Mittelvalve  
central blad  
valva central  
valve centrale  
valva centrale



15-824-00-07

Collin

15-823-00-07

20 cm / 7 7/8"

komplett, mit 1 Paar Seitenvalven Art.-Nr. 15-839-38-07 (38 x 60 mm) und Mittelvalve Art.-Nr. 15-823-90-98 (38 x 55 mm)  
complete, with 1 pair of lateral blades ref. 15-839-38-07 (38 x 60 mm) and central blade ref. 15-823-90-98 (38 x 55 mm)  
completo, con 1 par de valvas laterales ref. 15-839-38-07 (38 x 60 mm) y valva central ref. 15-823-90-98 (38 x 55 mm)  
complet, avec 1 paire de valves latérales réf. 15-839-38-07 (38 x 60 mm) et valve centrale réf. 15-823-90-98 (38 x 55 mm)  
completo, con 1 paio di valva laterali rif. 15-839-38-07 (38 x 60 mm) e valva centrale rif. 15-823-90-98 (38 x 55 mm)



100 mm

Collin

15-824-00-07

20 cm / 7 7/8"

komplett, mit 1 Paar Seitenvalven Art.-Nr. 15-839-45-07 (45 x 80 mm) und Mittelvalve Art.-Nr. 15-824-90-98 (50 x 75 mm)  
complete, with 1 pair of lateral blades ref. 15-839-45-07 (45 x 80 mm) and central blade ref. 15-824-90-98 (50 x 75 mm)  
completo, con 1 par de valvas laterales ref. 15-839-45 (45 x 80 mm) y valva central ref. 15-824-90-98 (50 x 75 mm)  
complet, avec 1 paire de valves latérales réf. 15-839-45-07 (45 x 80 mm) et valve centrale réf. 15-824-90-98 (50 x 75 mm)  
completo, con 1 paio di valva laterali rif. 15-839-45-07 (45 x 80 mm) e valva centrale rif. 15-824-90-98 (50 x 75 mm)



100 mm

## Bauchdeckenhalter

Abdominal Retractors  
Separadores abdominales  
Ecarteurs abdominaux  
Divaricatori addominali

Gesamtlänge Bauchdeckenhalter ohne Valve  
Total length of abdominal retractor without blade  
Longitud total separador abdominal sin valva  
Longueur totale écarteur abdominal sans valve  
Lunghezza totale divaricatore addominale senza valva



15-826-90-98

Mittelvalve  
central blad  
valva central  
valve centrale  
valva centrale



15-826-00-07

1/2

Collin  
15-826-00-07

31 cm / 12 2/8"

komplett, mit 1 Paar Seitenvalven Art.-Nr. 15-839-60-07  
(60 x 80 mm) und Mittelvalve Art.-Nr. 15-826-90-98 (60 x 75 mm)

complete, with 1 pair of lateral blades ref. 15-839-60-07  
(60 x 80 mm) and central blade ref. 15-826-90-98 (60 x 75 mm)

completo, con 1 par de valvas laterales ref. 15-839-60-07  
(60 x 80 mm) y valva central ref. 15-826-90-98 (60 x 75 mm)

complet, avec 1 paire de valves latérales réf. 15-839-60-07  
(60 x 80 mm) et valve centrale réf. 15-826-90-98 (60 x 75 mm)

completo, con 1 paio di valve laterali rif. 15-839-60-07  
(60 x 80 mm) e valva centrale réf. 15-826-90-98 (60 x 75mm)



140 mm



## Bauchdeckenhalter

Abdominal Retractors  
Separadores abdominales  
Ecarteurs abdominaux  
Divaricatori addominali

## Wundhaken

Retractors  
Separadores  
Ecarteurs  
Divaricatori



Gesamtlänge Bauchdeckenhalter ohne Valve  
Total length of abdominal retractor without blade  
Longitud total separador abdominal sin valva  
Longueur totale écarteur abdominal sans valve  
Lunghezza totale divaricatore addominale senza valva



### Ricard 15-830-00-07

komplett mit 1 Paar Seitenvalven Art.-Nr. 15-839-92-07 und Mittelvalve Art.-Nr. 15-830-04-07  
complete with 1 pair of lateral blades ref. 15-839-92-07 and central blade ref. 15-830-04-07  
completo con 1 par de valvas laterales ref. 15-839-92-07 y valva central ref. 15-830-04-07  
complet avec 1 paire de valves latérales ref. 15-839-92-07 et valve centrale ref. 15-830-04-07  
completo con 1 paio di valve laterali rif. 15-839-92-07 e valva centrale rif. 15-830-04-07



220 mm

### 15-830-02-07

Mittelvalve  
Central Blade  
Valva central  
Valva central  
Valva centrale

55 x 70 mm



15-828-00-07,  
15-830-00-07

### 15-830-04-07

Mittelvalve  
Central Blade  
Valva central  
Valva central  
Valva centrale

80 x 90 mm



15-828-00-07,  
15-830-00-07



### Ricard 15-828-00-07

komplett mit 1 Paar Seitenvalven Art.-Nr. 15-839-90-07 und Mittelvalve Art.-Nr. 15-830-02-07  
complete with 1 pair of lateral blades ref. 15-839-90-07 and central blade ref. 15-830-02-07  
completo con 1 par de valvas laterales ref. 15-839-90-07 y valva central ref. 15-830-02-07  
complet avec 1 paire de valves latérales ref. 15-839-90-07 et valve centrale ref. 15-830-02-07  
completo con 1 paio di valve laterali rif. 15-839-90-07 e valva centrale rif. 15-830-02-07



250 mm

### Ricard 15-828-01-07

Sperrer, allein  
Spreader, only  
Bastidor, suelto  
Ecarteur, seule  
Divaricatore, solo

### 15-839-90-07

Stück  
piece  
pieza  
pièce  
pezzo



15-820-00-07 –  
15-830-00-07,  
24-180-00-07

### 15-839-92-07

Stück  
piece  
pieza  
pièce  
pezzo



15-820-00-07 –  
15-830-00-07,  
24-180-00-07

## Seitenvalven

Lateral Blades

Valvas laterales

Valves laterales

Valve laterali



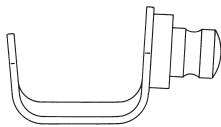
1/2

15-839-18-07 -  
15-839-60-07

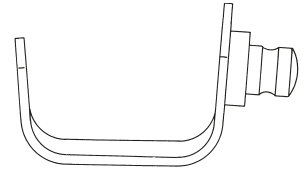
für Bauchdeckenhalter  
for abdominal retractors  
para separadores abdominales  
pour écarteurs abdominaux  
per divaricatori addominali



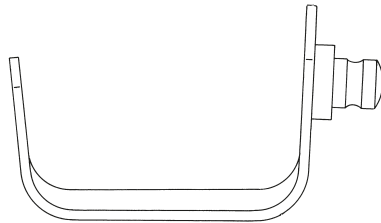
15-820-00-07 -  
15-830-00-07



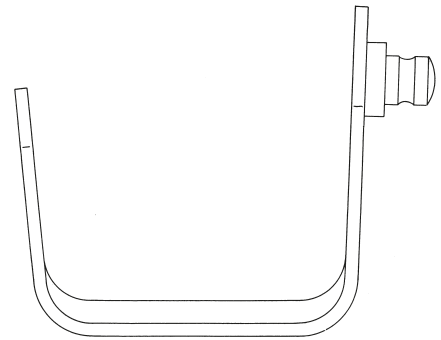
18 x 40 mm  
15-839-18-07



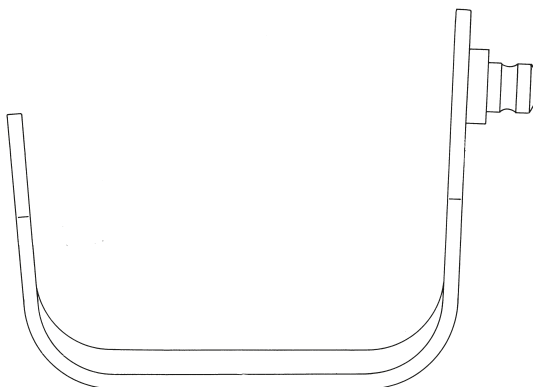
27 x 40 mm  
15-839-27-07



38 x 60 mm  
15-839-38-07



45 x 80 mm  
15-839-45-07



60 x 80 mm  
15-839-60-07

## Seitenvalven

Lateral Blades  
Valvas laterales  
Valves laterales  
Valve laterali

## Wundhaken

Retractors  
Separadores  
Écarteurs  
Divaricatori



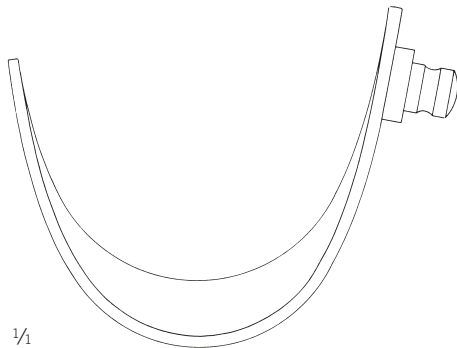
15-839-50-07 -  
15-839-94-07

für Bauchdeckenhalter  
for abdominal retractors  
para separadores abdominales  
pour écarteurs abdominaux  
per divaricatori addominali



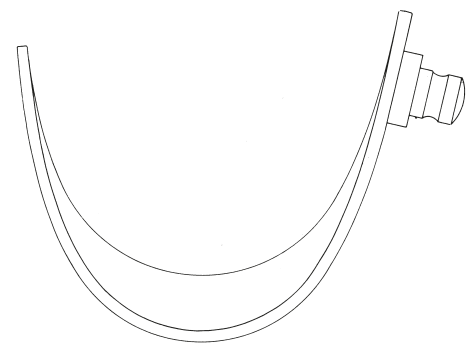
15-820-00-07 -  
15-830-00-07

1/2

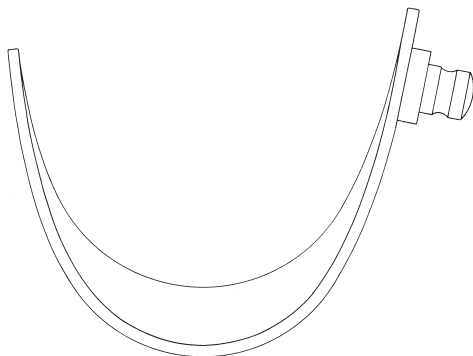


1/1

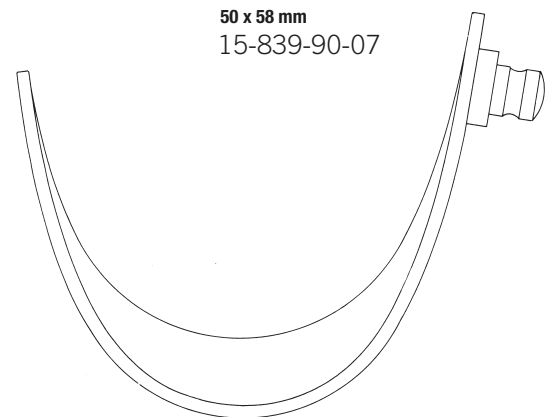
50 x 70 mm  
15-839-50-07



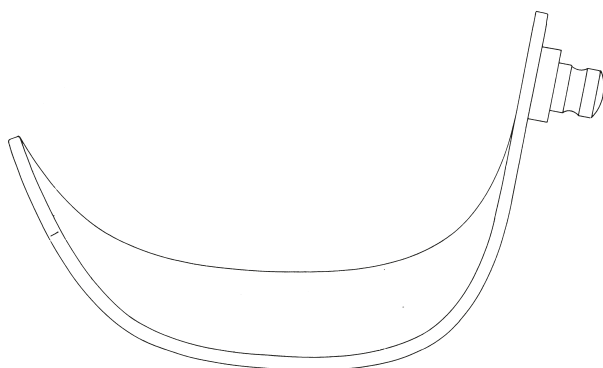
50 x 58 mm  
15-839-90-07



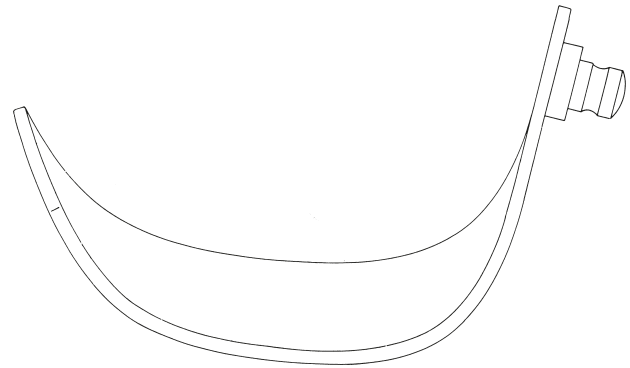
52 x 110 mm  
15-839-52-07



60 x 80 mm  
15-839-92-07



70 x 55 mm  
15-839-70-07



72 x 85 mm  
15-839-94-07

15

## Bauchdeckenhalter

Abdominal Retractors  
Separadores abdominales  
Ecarteurs abdominaux  
Divaricatori addominali



1/2

Gosset  
15-844-00-07 -  
15-844-91-98

16,5 cm / 6 7/8"

Seitenvalven 63 x 35 mm,  
1 Mittelvalve 60 x 65 mm  
lateral blades 63 x 35 mm,  
1 central blade 60 x 65 mm  
valvas laterales 63 x 35 mm,  
1 valva central 60 x 65 mm  
valves latérales 63 x 35 mm,  
1 valve centrale 60 x 65 mm  
valve laterali 63 x 35 mm,  
1 valva centrale 60 x 65 mm



160 mm

15-844-91-98

Mittelvalve  
central blad  
valva central  
valve centrale  
valva centrale  
**60 x 65 mm**



15-844-00-07



1/2

Gosset-Baby  
15-840-00-07

12,5 cm / 4 7/8"

Seitenvalven  
lateral blades  
valvas laterales  
valves latérales  
valve laterali  
**40 x 30 mm**



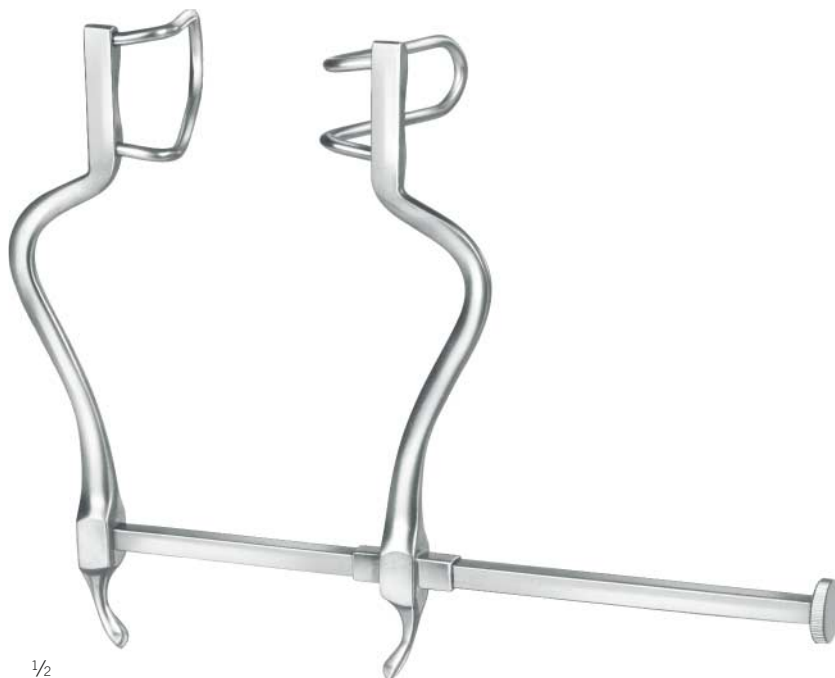
120 mm

## Bauchdeckenhalter

Abdominal Retractors  
Separadores abdominales  
Ecarteurs abdominaux  
Divaricatori addominali

## Wundhaken

Retractors  
Separadores  
Ecarteurs  
Divaricatori



1/2

### Gosset 15-846-00-07

18,5 cm / 7 3/8"

Seitenvalven  
lateral blades  
valvas laterales  
valves latérales  
valve laterali

**63 x 35 mm**



**140 mm**



1/2

### Balfour-Baby 15-850-00-07

12,5 cm / 4 7/8"

komplett, mit 1 Paar Seitenvalven (30 x 20 mm)  
und Mittelvalve (24 x 20 mm)

complete, with 1 pair of lateral blades (30 x 20 mm)  
and central blade (24 x 20 mm)

completo, con 1 par de valvas laterales (30 x 20 mm)  
y valva central (24 x 20 mm)

complet, avec 1 paire de valves latérales (30 x 20 mm)  
et valve centrale réf. (24 x 20 mm)

completo, con 1 paio di valve laterali (30 x 20 mm)  
e valva centrale rif. (24 x 20 mm)



**80 mm**

## Bauchdeckenhalter

Abdominal Retractors

Separadores abdominales

Ecarteurs abdominaux

Divaricatori addominali



1/2

### Balfour

15-852-00-07

23 cm / 9"

komplett, mit 1 Paar Seitenvalven (70 x 35 mm) und Mittelvalve Art.-Nr. 15-859-01-07 (45 x 80 mm)

complete, with 1 pair of lateral blades (70 x 35 mm) and central blade ref. 15-859-01-07 (45 x 80 mm)

completo, con 1 par de valvas laterales (70 x 35 mm) y valva central ref. 15-859-01-07 (45 x 80 mm)

complet, avec 1 paire de valves latérales (70 x 35 mm) et valve centrale réf. 15-859-01-07 (45 x 80 mm)

completo, con 1 paio di valve laterali (70 x 35 mm) e valva centrale rif. 15-859-01-07 (45 x 80 mm)



1/2

### Balfour

15-854-00-07

23 cm / 9"

komplett, mit 1 Paar Seitenvalven (70 x 35 mm) und Mittelvalve Art.-Nr. 15-859-01-07 (45 x 80 mm)

complete, with 1 pair of lateral blades (70 x 35 mm) and central blade ref. 15-859-01-07 (45 x 80 mm)

completo, con 1 par de valvas laterales (70 x 35 mm) y valva central ref. 15-859-01-07 (45 x 80 mm)

complet, avec 1 paire de valves latérales (70 x 35 mm) et valve centrale réf. 15-859-01-07 (45 x 80 mm)

completo, con 1 paio di valve laterali (70 x 35 mm) e valva centrale rif. 15-859-01-07 (45 x 80 mm)



## Bauchdeckenhalter, Mittelvalven

Abdominal Retractors, Central Blades  
Separadores abdominales, valvas centrales  
Ecarteurs abdominaux, valves centrales  
Divaricatori addominali, valve centrali

## Wundhaken

Retractors  
Separadores  
Ecarteurs  
Divaricatori



1/2

### Balfour 15-856-00-07

24 cm / 9 5/8"

komplett, mit 1 Paar Seitenvalven (100 x 35 mm)  
und Mittelvalve Art.-Nr. 15-856-91-98 (100 x 60 mm)

complete, with 1 pair of lateral blades (100 x 35 mm)  
and central blade ref. 15-856-91-98 (100 x 60 mm)

completo, con 1 par de valvas laterales (100 x 35 mm)  
y valva central ref. 15-856-91-98 (100 x 60 mm)

complet, avec 1 paire de valves latérales (100 x 35 mm)  
et valve centrale réf. 15-856-91-98 (100 x 60 mm)

completo, con 1 paio di valve laterali (100 x 35 mm)  
e valva centrale rif. 15-856-91-98 (100 x 60 mm)



180 mm

15-856-90-98

Mittelvalve  
central blade  
valva central  
vlave centrale  
vlava centrale  
**100 x 70 mm**



15-856-00-07

15-856-91-98

Mittelvalve  
central blade  
valva central  
vlave centrale  
vlava centrale  
**100 x 60 mm**



15-856-00-07

## Bauchdeckenhalter, Mittelvalven

Abdominal Retractors  
Separadores abdominales  
Ecarteurs abdominaux  
Divaricatori addominali



1/2

### Balfour-Standard 15-858-00-07

30 cm / 11 9/16"

komplett, mit 1 Paar Seitenvlaven (100 x 35 mm)  
und Mittelvalve Art.-Nr. 15-859-02-07 (68 x 85 mm)

complete, with 1 pair of lateral blades (100 x 35 mm)  
and central blade ref. 15-859-02-07 (68 x 85 mm)

completo, con 1 par de valvas laterales (100 x 35 mm)  
y valva central ref. 15-859-02-07 (68 x 85 mm)

complet, avec 1 paire de valves latérales (100 x 35 mm)  
et valve centrale réf. 15-859-02-07 (68 x 85 mm)

completo, con 1 paio di valve laterali (100 x 35 mm)  
e valva centrale rif. 15-859-02-07 (68 x 85 mm)



230 mm



1/2

### Balfour 15-859-01-07 - 15-859-06-07

15-859-01-07

**45 x 80 mm**

15-859-02-07

**68 x 85 mm**

15-859-06-07

**40 x 68 mm**



## Bauchdeckenhalter

Abdominal Retractors  
Separadores abdominales  
Ecarteurs abdominaux  
Divaricatori addominali

## Wundhaken

Retractors  
Separadores  
Ecarteurs  
Divaricatori



1/2

### Balfour, Mod. USA 15-860-00-07

25 cm / 9 7/8"

komplett, mit je 1 Paar Seitenvälven Art.-Nr. 15-860-06-07 (60 x 30 mm), 15-860-08-07 (80 x 30 mm) und Mittelvalve Art.-Nr. 15-859-02-07 (68 x 85 mm)

complete, with 1 pair of lateral blades ref. 15-860-06-07 (60 x 30 mm), 15-860-08-07 (80 x 30 mm) and central blade ref. 15-859-02-07 (68 x 85 mm)

completo, con 1 par de valvas laterales ref. 15-860-06-07 (60 x 30 mm), 15-860-08-07 (80 x 30 mm) y valva central ref. 15-859-02-07 (68 x 85 mm)

complet, avec 1 paire de valves latérales réf. 15-860-06-07 (60 x 30 mm), 15-860-08-07 (80 x 30 mm) et valve centrale réf. 15-859-02-07 (68 x 85 mm)

completo, con 1 paio di valve laterali rif. 15-860-06-07 (60 x 30 mm), 15-860-08-07 (80 x 30 mm) e valva centrale rif. 15-859-02-07 (68 x 85 mm)



190 mm



### 15-860-06-07

Drahtvalven (Paar)  
Fenestrated Blades (pair)  
Valvas de alambre (par)  
Valves en fil (paire)  
Valve di filo (paio)

60 x 30 mm



15-860-00-07



### 15-860-08-07

Drahtvalven (Paar)  
Fenestrated Blades (pair)  
Valvas de alambre (par)  
Valves en fil (paire)  
Valve di filo (paio)

80 x 30 mm



15-860-00-07

## Bauchdeckenhalter, Mittelvalven

Abdominal Retractors, Central Blades  
Separadores abdominales, valvas centrales  
Ecarteurs abdominaux, valves centrales  
Divaricatori addominali, valve centrali



1/2

### O'Sullivan-O'Connor 15-868-00-01

20 cm / 7 7/8"

komplett, mit 2 festen Seitenvalven (60 x 35 mm)  
und 2 Mittelvalven Art.-Nr. 15-868-90-98 (80 x 45 mm) und 15-868-91-98 (110 x 70 mm)

complete, with 2 fixed lateral blades (60 x 35 mm)  
and 2 central blades ref. 15-868-90-98 (80 x 45 mm) and 15-868-91-98 (110 x 70 mm)

completo, con 2 valvas laterales fijas (60 x 35 mm)  
y 2 valvas centrales ref. 15-868-90-98 (80 x 45 mm) y 15-868-91-98 (110 x 70 mm)

complet, avec 2 valves latérales fixes (60 x 35 mm)  
et 2 valves centrales réf. 15-868-90-98 (80 x 45 mm) et 15-868-91-98 (110 x 70 mm)

completo, con 2 valve laterali fisse (60 x 35 mm)  
e 2 valve centrali rif. 15-868-90-98 (80 x 45 mm) e 15-868-91-98 (110 x 70 mm)



### 15-868-90-98

Mittelvalve  
central blad  
valva central  
valve centrale  
valva centrale  
**80 x 45 mm**



**15-868-00-01**

### 15-868-91-98

Mittelvalve  
central blad  
valva central  
valve centrale  
valva centrale  
**110 x 70 mm**



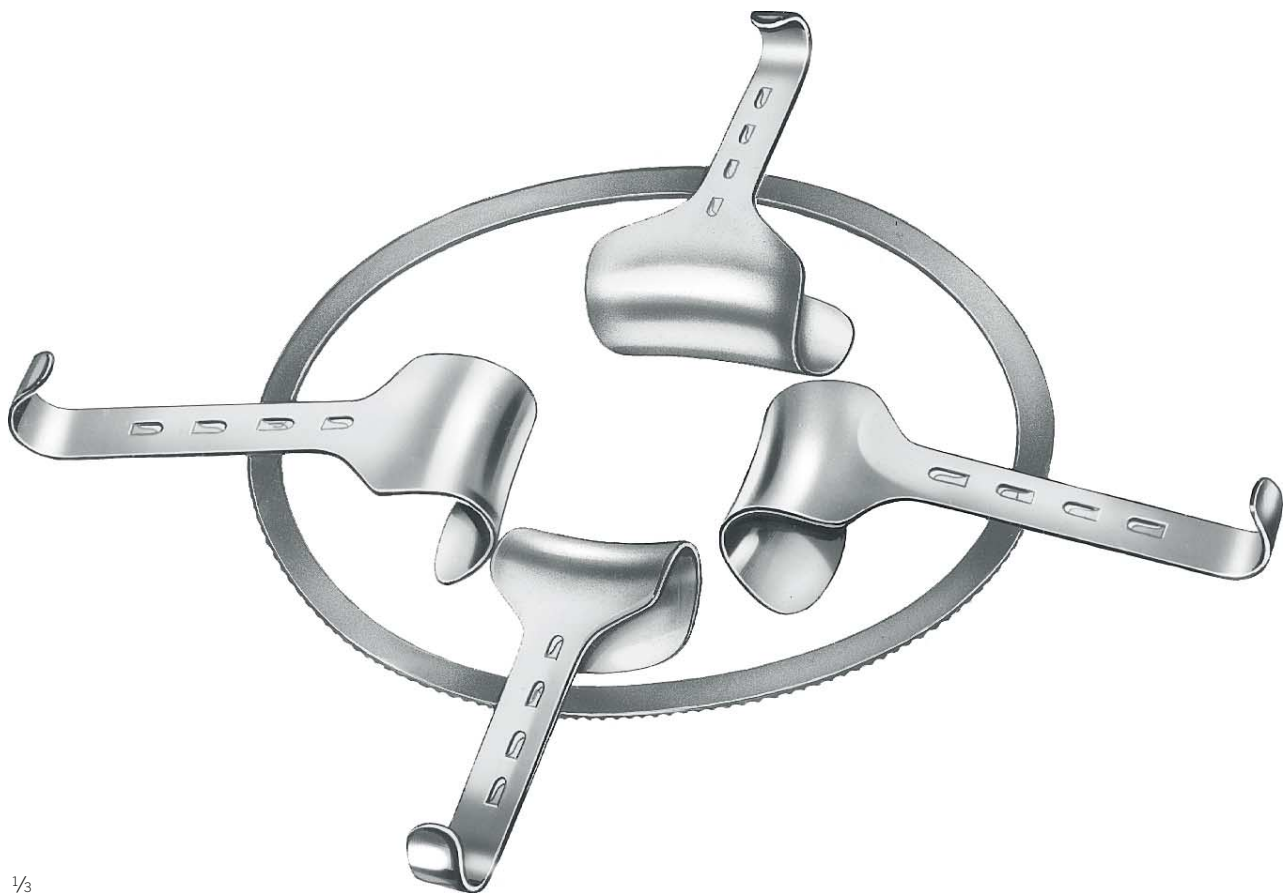
**15-868-00-01**

## Bauchdeckenhalter

Abdominal Retractors  
Separadores abdominales  
Ecarteurs abdominaux  
Divaricatori addominali

## Wundhaken

Retractors  
Separadores  
Ecarteurs  
Divaricatori



1/3

### Kirschner 15-882-00-07

Rahmen Art.-Nr. 15-882-30-07, 3 Haken Art.-Nr. 15-889-50-07, und je 1 Haken Art.-Nr. 15-889-80-07, 15-889-98-07 und 15-889-99-07

Frame ref. 15-882-30-07, 3 retractors ref. 15-889-50-07 and 1 retractor each ref. 15-889-80-07, 15-889-98-07 and 15-889-99-07

Bastidor ref. 15-882-30-07, 3 retractor ref. 15-889-50-07 y 1 retractor c.u. ref. 15-889-80-07, 15-889-98-07 y 15-889-99-07

Cadre réf. 15-882-30-07, 3 rétracteurs réf. 15-889-50-07 et avec 1 rétracteurs réf. 15-889-80-07, 15-889-98-07 et 15-889-99-07

Telaio cod. art. 15-882-30-07, 3 retrattori cod. art. 15-889-50-07 e 1 retrattore ciascuno, cod. art. 15-889-80-07, 15-889-98-07 e 15-889-99-07

### Kirschner 15-882-30-07

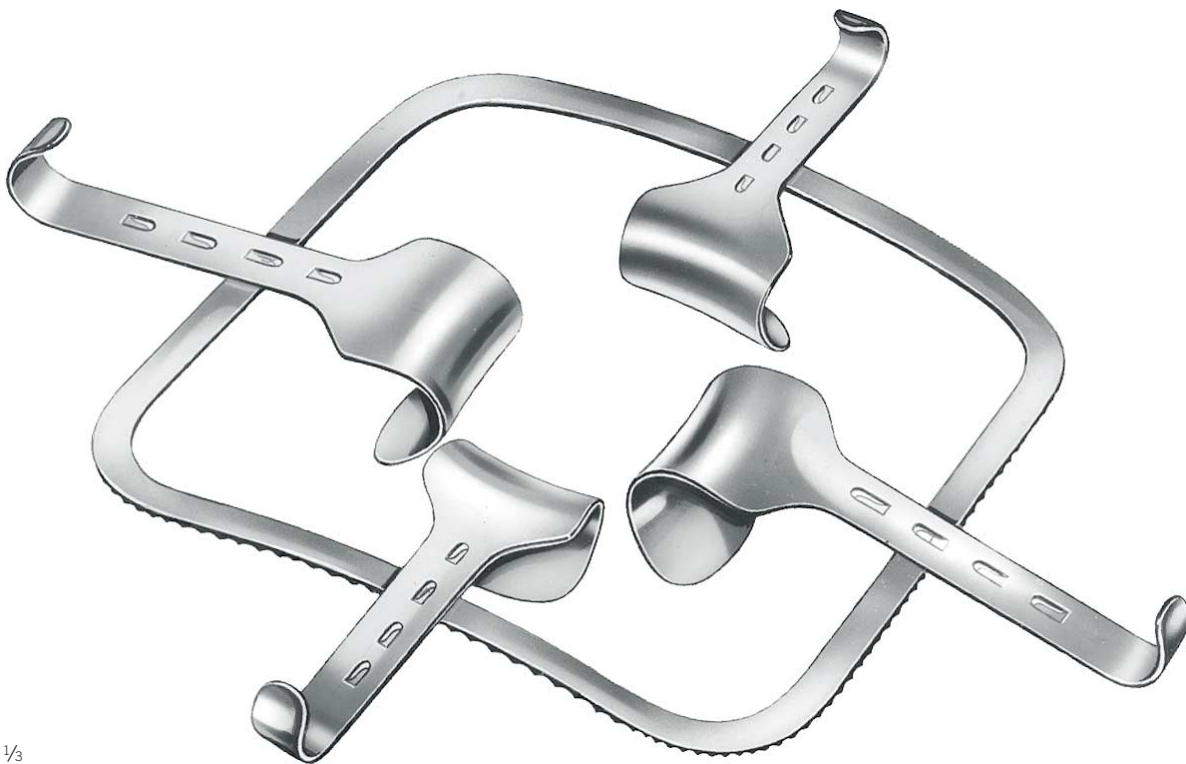
Rahmen, allein  
Frame, only  
Cuadro, solo  
Cadre, seul  
Telaio, solo

Innenmaß  
Internal dimensions  
Dimensiones interiores  
Dimension intérieure  
Misura interna

**300 x 240 mm**

## Bauchdeckenhalter

Abdominal Retractors  
Separadores abdominales  
Ecarteurs abdominaux  
Divaricatori addominali



1/3

### Kirschner 15-884-00-07

Rahmen Art.-Nr. 15-884-24-07  
und je 2 Haken Art.-Nr. 15-889-40-07 und 15-889-50-07

frame ref. 15-884-24-07,  
2 hooks ref. 15-889-40-07 and 2 hooks ref. 15-889-50-07

bastidor ref. 15-884-24-07,  
2 ganchos ref. 15-889-40-07 y 2 ganchos ref. 15-889-50-07

cadre réf. 15-884-24-07,  
2 valves réf. 15-889-40-07 et 2 valves réf. 15-889-50-07

telaio rif. 15-884-24-07,  
2 valve rif. 15-889-40-07 e 2 valve rif. 15-889-50-07

### Kirschner 15-884-24-07

Rahmen, allein

Frame, only

Cuadro, solo

Cadre, seul

Telaio, solo

Innenmaß

Internal dimensions

Dimensiones interiores

Dimension intérieure

Misura interna

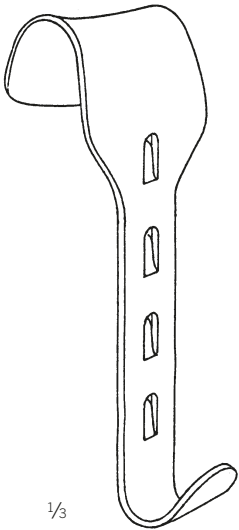
**240 x 240 mm**

## Valven

Blades  
Valvas  
Valves  
Valve

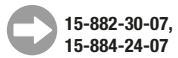
## Wundhaken

Retractors  
Separadores  
Ecarteurs  
Divaricatori

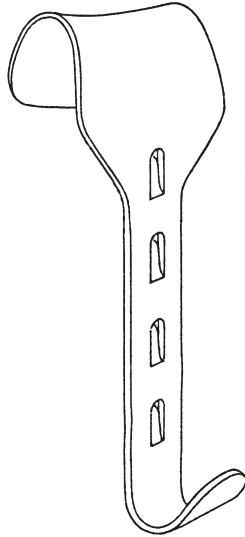


1/3

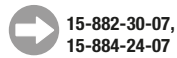
15-889-40-07  
40 x 55 mm  
Standard



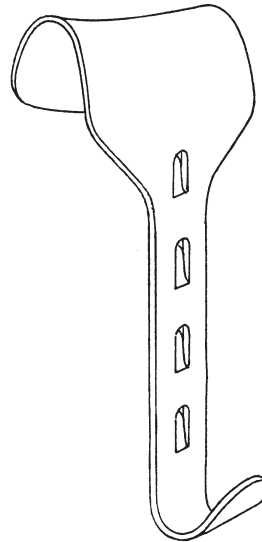
15-882-30-07,  
15-884-24-07



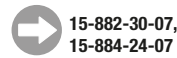
15-889-50-07  
50 x 65 mm  
Standard



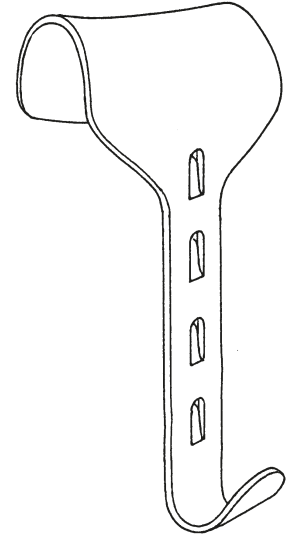
15-882-30-07,  
15-884-24-07



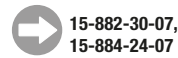
15-889-60-07  
60 x 85 mm  
Standard



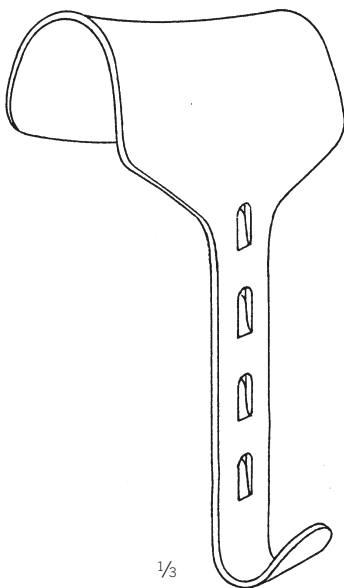
15-882-30-07,  
15-884-24-07



15-889-78-07  
78 x 65 mm

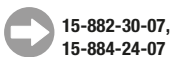


15-882-30-07,  
15-884-24-07

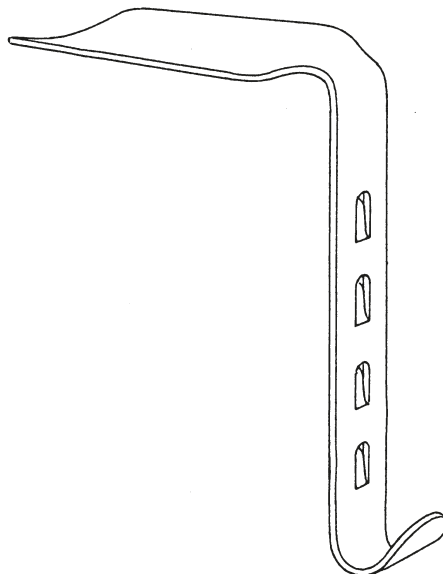


1/3

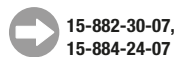
15-889-80-07  
85 x 90 mm



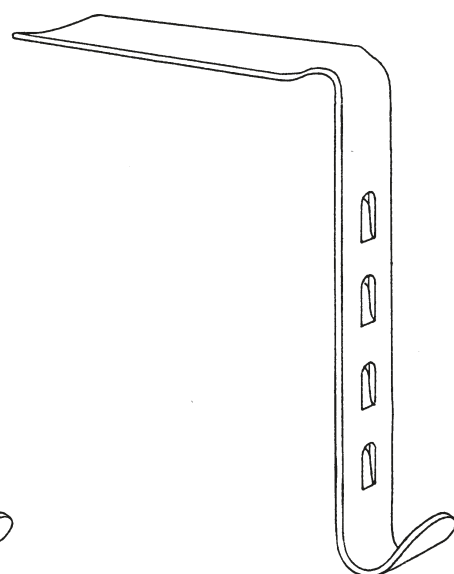
15-882-30-07,  
15-884-24-07



15-889-98-07  
98 x 50 mm



15-882-30-07,  
15-884-24-07



15-889-99-07  
105 x 35 mm



15-882-30-07,  
15-884-24-07

## Laminektomiesperrer

Laminectomy Retractors  
Separadores para laminectomía  
Ecarteurs pour laminectomie  
Divaricatori per laminectomia



1/2

Scoville  
15-906-00-07  
22 cm / 8 5/8"



1/2

Scoville-Haverfield  
15-906-50-07  
22 cm / 8 5/8"

Rahmen allein, mit Gelenk  
frame only, with joint  
bastidor suelto, con articulación  
cadre seul, avec articulation  
telaio solo, con articolazione



## Valven

Blades  
Valvas  
Valves  
Valve

## Wundhaken

Retractors  
Separadores  
Ecarteurs  
Divaricatori



1/2

15-906-01-07  
5 cm / 2"

Hakenvalve, Stück  
Hook, piece  
Gancho, pieza  
Valve à griffes, pièce  
Uncino, pezzo

50 mm tief, stumpf  
50 mm deep, blunt  
50 mm de profundidad, romo  
profondeur 50 mm, mousse  
profondità 50 mm, smusso



15-906-00-07,  
15-906-50-07



15-906-02-07  
7 cm / 2 6/8"

Hakenvalve, Stück  
Hook, piece  
Gancho, pieza  
Valve à griffes, pièce  
Uncino, pezzo

70 mm tief, stumpf  
70 mm deep, blunt  
70 mm de profundidad, romo  
profondeur 70 mm, mousse  
profondità 70 mm, smusso



15-906-00-07,  
15-906-50-07



15-906-06-07  
5 cm / 2"

Hakenvalve, Stück  
Hook, piece  
Gancho, pieza  
Valve à griffes, pièce  
Uncino, pezzo

50 mm tief, spitz  
50 mm deep, sharp  
50 mm de profundidad, agudo  
profondeur 50 mm, pointu  
profondità 50 mm, acuto



15-906-00-07,  
15-906-50-07



15-906-07-07  
7 cm / 2 6/8"

Hakenvalve, Stück  
Hook, piece  
Gancho, pieza  
Valve à griffes, pièce  
Uncino, pezzo

70 mm tief, spitz  
70 mm deep, sharp  
70 mm de profundidad, agudo  
profondeur 70 mm, pointu  
profondità 70 mm, acuto



15-906-00-07,  
15-906-50-07

15



1/2

15-906-11-07 -  
15-906-13-07

Blattvalven, Stück  
Blades, piece  
Valvas, pieza  
Valves, pièce  
Valve, pezzo

gezahnt  
toothed  
dentado  
dentelé  
dentato



15-906-00-07,  
15-906-50-07



15-906-41-07 -  
15-906-44-07

Hakenvalve, Stück  
Hook, piece  
Valva, pieza  
Valve, pièce  
Valvola, pezzo

spitz  
sharp  
agudo  
pointu  
acuto



15-906-00-07,  
15-906-50-07



15-906-46-07 -  
15-906-47-07

Hakenvalve, Stück  
Hook, piece  
Valva, pieza  
Valve, pièce  
Valvola, pezzo

spitz  
sharp  
agudo  
pointu  
acuto



15-906-00-07,  
15-906-50-07

|              |            |              |            |              |            |
|--------------|------------|--------------|------------|--------------|------------|
| 15-906-11-07 | 60 x 25 mm | 15-906-41-07 | 48 x 50 mm | 15-906-46-07 | 44 x 38 mm |
| 15-906-12-07 | 61 x 50 mm | 15-906-42-07 | 64 x 50 mm | 15-906-47-07 | 67 x 44 mm |
| 15-906-13-07 | 86 x 25 mm | 15-906-43-07 | 64 x 64 mm |              |            |
|              |            | 15-906-44-07 | 80 x 57 mm |              |            |

## Martin Arm-System

Martin Arm System  
Sistema Brazo Martin  
Système Bras Martin  
Sistema braccio Martin



Martin  
15-910-01-07

Martin Arm-System  
Martin Arm System  
Sistema Brazo Martin  
Système Bras Martin  
Sistema braccio Martin

15-910-50-07

Universal-Befestigungskloben für Martin-Arm-System  
Universal Fixation Clamp for Martin Arm system  
Mordaza universal para sistema brazo Martin  
Etau de maintien universel pour système bras Martin  
Morsetto di fissaggio universale per sistema braccio Martin

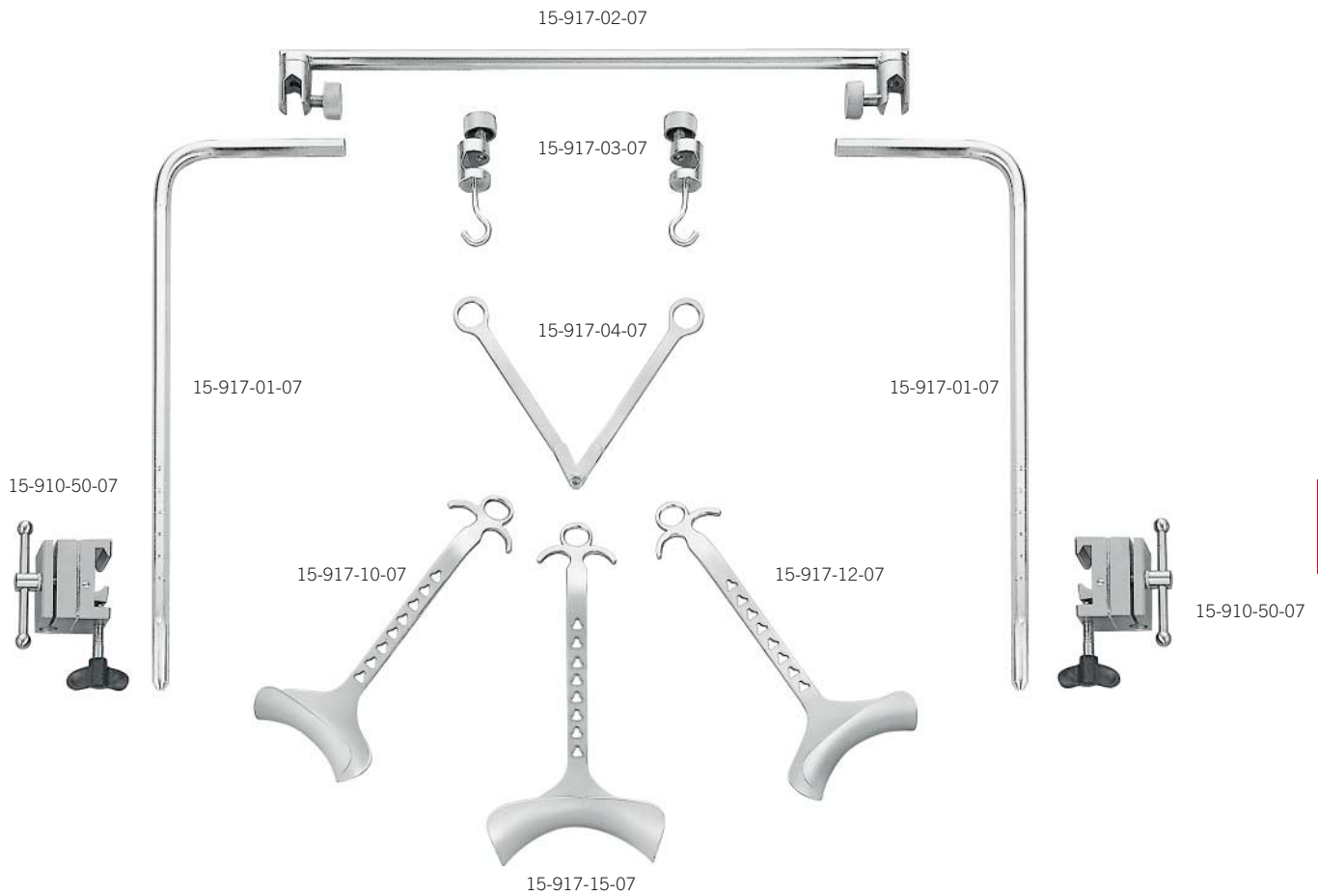


## Hakensystem

Retractor System  
Sistema de Retractores  
Systèmes des ecarteurs  
Sistema divaricatori

## Wundhaken

Retractors  
Separadores  
Ecarteurs  
Divaricatori



15

## Martin-Rochard 15-917-00-07

Hakensystem  
Retractor System  
Sistema de Retractores  
Système d'écartereurs  
Sistema di divaricatori

| komplett bestehend aus: |                                | complete consisting of: |                            | completo compuesto de: |                                |
|-------------------------|--------------------------------|-------------------------|----------------------------|------------------------|--------------------------------|
| 15-910-50-07            | 2 Universal-Befestigungskloben | 15-910-50-07            | 2 Universal Fixation Clamp | 15-910-50-07           | 2 Mordaza universal            |
| 15-917-01-07            | 2 Haltearm, seitlich           | 15-917-01-07            | 2 Fixation Arm, lateral    | 15-917-01-07           | 2 Brazo de fijación, lateral   |
| 15-917-02-07            | 1 Querstab, Sechskant          | 15-917-02-07            | 1 Cross Bar, hexagon       | 15-917-02-07           | 1 Barra transversal, hexagonal |
| 15-917-03-07            | 2 Kloben                       | 15-917-03-07            | 2 Sliding Clamp            | 15-917-03-07           | 2 Garrucha                     |
| 15-917-04-07            | 1 Halterung für Haken          | 15-917-04-07            | 1 Fixing device for hooks  | 15-917-04-07           | 1 Soporte para ganchos         |
| 15-917-10-07            | 1 Wundhaken, 50 x 105 mm       | 15-917-10-07            | 1 Retractor, 50 x 105 mm   | 15-917-10-07           | 1 Separador, 50 x 105 mm       |
| 15-917-12-07            | 1 Wundhaken, 50 x 120 mm       | 15-917-12-07            | 1 Retractor, 50 x 120 mm   | 15-917-12-07           | 1 Separador, 50 x 120 mm       |
| 15-917-15-07            | 1 Wundhaken, 50 x 160 mm       | 15-917-15-07            | 1 Retractor, 50 x 160 mm   | 15-917-15-07           | 1 Separador, 50 x 160 mm       |

| complet composé de: |                                  | completo composto di: |                                    |
|---------------------|----------------------------------|-----------------------|------------------------------------|
| 15-910-50-07        | 2 Etau de maintien universel     | 15-910-50-07          | 2 Morsetto di fissaggio universale |
| 15-917-01-07        | 2 Bras de fixation, latérale     | 15-917-01-07          | 2 Braccio di fissaggio, laterale   |
| 15-917-02-07        | 1 Barre transversale, hexagonale | 15-917-02-07          | 1 Barra trasversale, hexagonale    |
| 15-917-03-07        | 2 Etau                           | 15-917-03-07          | 2 Carrucola mobile                 |
| 15-917-04-07        | 1 Maintien pour crochets         | 15-917-04-07          | 1 Supporto per divaricatori        |
| 15-917-10-07        | 1 Ecarteur, 50 x 105 mm          | 15-917-10-07          | 1 Divaricatore, 50 x 105 mm        |
| 15-917-12-07        | 1 Ecarteur, 50 x 120 mm          | 15-917-12-07          | 1 Divaricatore, 50 x 120 mm        |
| 15-917-15-07        | 1 Ecarteur, 50 x 160 mm          | 15-917-15-07          | 1 Divaricatore, 50 x 160 mm        |

## marTract® Wundspreizersystem

marTract® Retractor System

Sistema retractor marTract®

Système écarteur marTract®

Sistema divaricatore marTract®

## Surgery

### Standard Frame

Abdominal Rectal Surgery

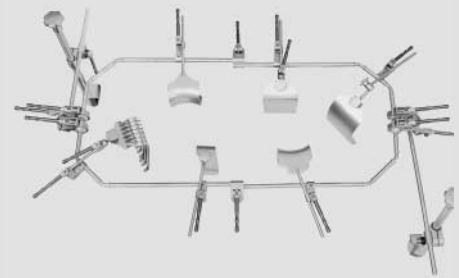


Abdominal Surgery



### Standard Frame

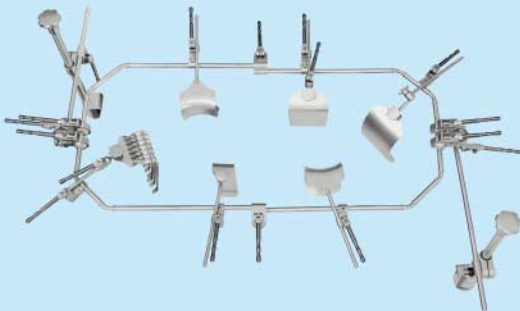
Obesity Surgery



## Gynaecology

### Standard Frame

Gynaecological Obesity



Abdominal Gynaecology



### Compact Frame

System for Axilla/Breast Surgery



## marTract® Retractor System



## Transplant Surgery

### Standard Frame

Kidney Transplantation

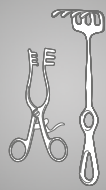


## marTract® Wundspeizersystem

marTract® Retractor System  
Sistema retractor marTract®  
Système écarteur marTract®  
Sistema divaricatore marTract®

## Wundhaken

Retractors  
Separadores  
Ecarteurs  
Divaricatori



### Compact Frame

Pediatrics



Proctology

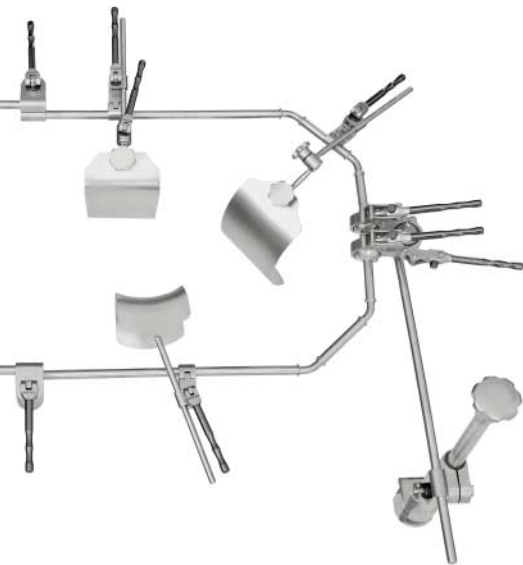


Laparoscopic Liver



### Rochard-System

Epigastrium Set



### Rochard-System

Liver Transplantation



## Urology

### Standard Frame

Abdominal Urology



### Compact Frame

Pediatrics



Perineal Prostatectomy



## marTract® Komponenten

marTract® Components  
Componentes marTract®  
Composants marTract®  
Componenti marTract®



1/3

15-920-10-07

Halterung, OP-Tisch  
Bracket, operating table  
Soporte, mesa de operaciones  
Support, table d'opération  
Supporto, tavolo operatorio



1/3

15-920-11-07

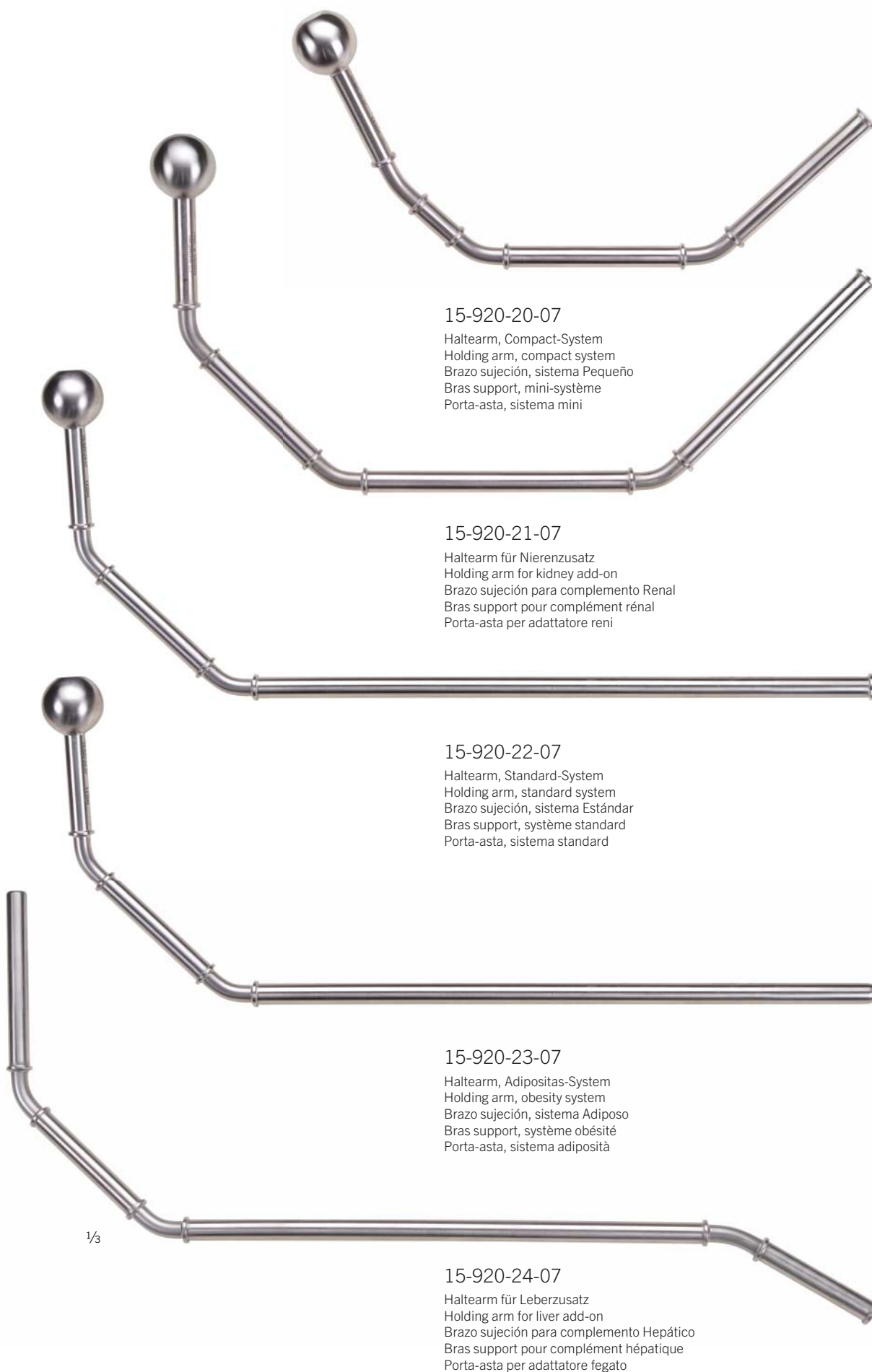
Halterung, OP-Tisch, Oberbauch  
Bracket, operating table, epigastrium  
Soporte, mesa de operaciones, epigastrio  
Support, table d'opération, abdomen supérieur  
Supporto, tavolo operatorio, addome superiore

## marTract® Komponenten

marTract® Components  
Componentes marTract®  
Composants marTract®  
Componenti marTract®

## Wundhaken

Retractors  
Separadores  
Écarteurs  
Divaricatori



15-920-20-07

Haltearm, Compact-System  
Holding arm, compact system  
Brazo sujeción, sistema Pequeño  
Bras support, mini-système  
Porta-asta, sistema mini

15-920-21-07

Haltearm für Nierenzusatz  
Holding arm for kidney add-on  
Brazo sujeción para complemento Renal  
Bras support pour complément rénal  
Porta-asta per adattatore reni

15-920-22-07

Haltearm, Standard-System  
Holding arm, standard system  
Brazo sujeción, sistema Estándar  
Bras support, système standard  
Porta-asta, sistema standard

15-920-23-07

Haltearm, Adipositas-System  
Holding arm, obesity system  
Brazo sujeción, sistema Adiposo  
Bras support, système obésité  
Porta-asta, sistema adiposità

15-920-24-07

Haltearm für Leberzusatz  
Holding arm for liver add-on  
Brazo sujeción para complemento Hepático  
Bras support pour complément hépatique  
Porta-asta per adattatore fegato

1/3

15

## marTract® Komponenten

marTract® Components  
Componentes marTract®  
Composants marTract®  
Componenti marTract®



15-920-30-07

Querstange für 15-920-34-07  
Transverse rod for 15-920-34-07  
Varilla transversal para 15-920-34-07  
Barre transversale pour 15-920-34-07  
Barra trasversale per 15-920-34-07



15-920-31-07

Verlängerung für Rektumzusatz  
Extension for rectum add-on  
Prolongación para complemento Rectal  
Rallonge pour complément anal  
Prolunga per adattatore retto



15-920-33-07

Distanzhalter für Radialkolben  
Spacer for radial piston  
Espaciador para pistón radial  
Écarteur pour piston radial  
Supporto distanza per stantuffo radiale

## marTract® Komponenten

marTract® Components  
Componentes marTract®  
Composants marTract®  
Componenti marTract®

## Wundhaken

Retractors  
Separadores  
Écarteurs  
Divaricatori



1/3

### 15-920-32-07

Verbinder für Adipositas-System  
Connector for obesity system  
Connector para sistema adiposo  
Connecteur pour système obésité  
Elemento di collegamento sistema adiposità



1/3

### 15-920-34-07

Kugelaufnahme für Haltearme  
Ball mount for holding arms  
Rótula para brazos de sujeción  
Logement rotule pour bras support  
Alloggiamento sfera per Porta-asta



1/3

### 15-920-35-07

Fixierklammer für Wundhaken  
Fixing clip for retractor  
Clip fijación para separadores  
Pince de fixation pour écarteur  
Clip fissaggio per divaricatore



1/3

### 15-920-40-07

Blatthalter, starr  
Blade holder, fixed  
Soporte para hoja, rígido  
Porte-lame, rigide  
Porta-lama, rigido



1/3

### 15-920-42-07

Blatthalter, beweglich  
Blade holder, movable  
Soporte para hoja, móvil  
Porte-lame, mobile  
Porta-lama, mobile



1/3

### 15-920-43-07

Blatthalter für Oberbauchzusatz  
Blade holder for epigastrium add-on  
Soporte para hoja complemento epigastrio  
Porte-lame pour complément abdomen supérieur  
Porta-lama per additivo addome superiore



1/3

### 15-920-44-07

Blatthalter mit Raste, 20 cm  
Blade holder, with stop, 20 cm  
Soporte para hoja, tope, 20 cm  
Porte-lame, avec cran, 20 cm  
Porta-lama, con tacca, 20 cm



1/3

### 15-920-45-07

Blatthalter mit Raste, 40 cm  
Blade holder, with stop, 40 cm  
Soporte para hoja, tope, 40 cm  
Porte-lame, avec cran, 40 cm  
Porta-lama, con tacca, 40 cm

15

## marTract® Komponenten

marTract® Components  
Componentes marTract®  
Composants marTract®  
Componenti marTract®



1/3

15-920-51-07

Zugvorrichtung für Oberbauch  
Pulling device for epigastrium  
Dispositivo de tracción para epigastrio  
Dispositif de traction pour abdomen supérieur  
Dispertrazione per addome superiore

15-920-60-04

Universallichtleitkabel  
Universal fiber optic cable  
Cable de fibra óptica Universal  
Câble à fibres optiques universal  
Cavo fibra ottica universale

15-920-90-07

Haltearm für laparoskopischen Leberhaken  
Fixation for laparoscopic Liver hooklet  
Razo sujeción para gancho hepático laparoscopico  
Bras support pour ecarteur laparoscopique  
Porta-asta per divaricatore laparoscopico

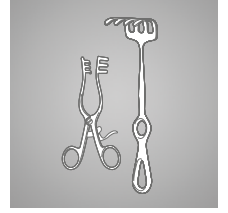


## marTract® Komponenten

marTract® Components  
Componentes marTract®  
Composants marTract®  
Componenti marTract®

## Wundhaken

Retractors  
Separadores  
Ecarteurs  
Divaricatori



1/2

15-921-01-07  
150 x 100 mm



1/2

15-921-02-07  
200 x 100 mm



1/2

15-921-03-07  
250 x 100 mm



1/3

15-921-01-07 -  
15-921-03-07

Darmblatt, breit  
Intestine blade, wide  
Hoja intestina, ancha  
Lame intestin, large  
Lama intestina, larga

15

## marTract® Komponenten

marTract® Components  
Componentes marTract®  
Composants marTract®  
Componenti marTract®



15-921-10-07 -  
15-921-13-07

Darmblatt, breit  
Intestine blade, wide  
Hoja intestinal, ancha  
Lame intestin, large  
Lama intestinal, larga



15-921-12-07  
300 x 50 mm

Blatt, biegsam, Spatel  
Blade, flexible, spatula  
Hoja, flexible, espátula  
Lame, flexible, spatule  
Lama, flessibile, spatola

## marTract® Komponenten

marTract® Components  
Componentes marTract®  
Composants marTract®  
Componenti marTract®

## Wundhaken

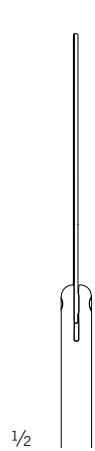
Retractors  
Separadores  
Ecarteurs  
Divaricatori



1/3

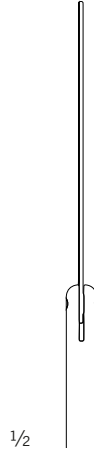
15-921-20-07 -  
15-921-21-07

Uro, Haken, biegsam  
Uro, retractor, flexible  
Uro, gancho, flexible  
Uro, crochet, flexible  
Uro, divaricatore, flessibile



1/2

15-921-20-07  
50 x 20 mm



1/2

15-921-21-07  
60 x 20 mm



1/3

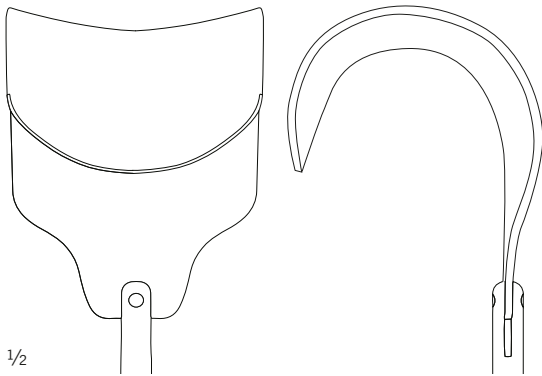
15-921-22-07  
100 x 25 mm

Uro, Blatt, biegsam  
Uro, blade, flexible  
Uro, hoja, flexible  
Uro, lame, flexible  
Uro, lama, flessibile

15

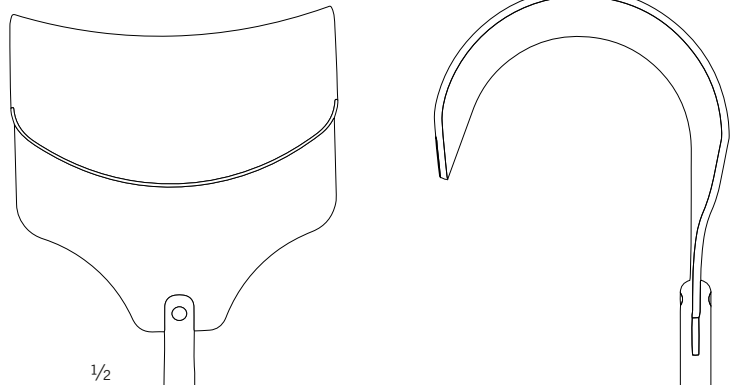
## marTract® Komponenten

marTract® Components  
Componentes marTract®  
Composants marTract®  
Componenti marTract®



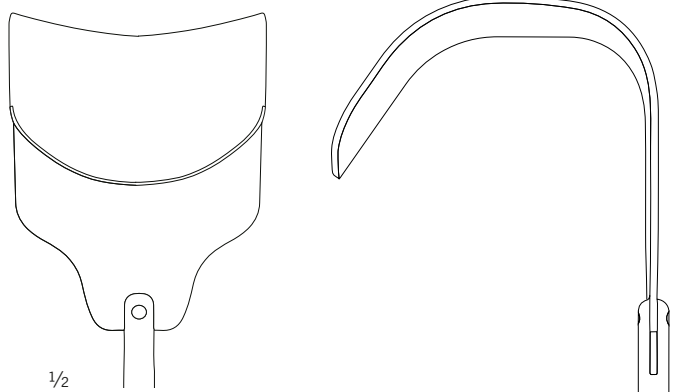
1/2

15-921-30-07  
50 x 65 mm



1/2

15-921-31-07  
60 x 85 mm



1/2

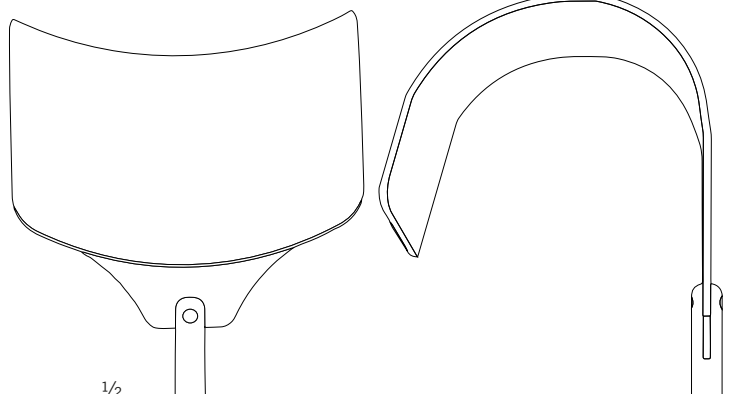
15-921-32-07  
78 x 65 mm



1/3

Kirschner  
15-921-30-07 -  
15-921-33-07

Haken  
Retractor  
Gancho  
Crochet  
Divaricatore



1/2

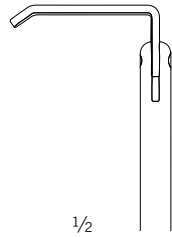
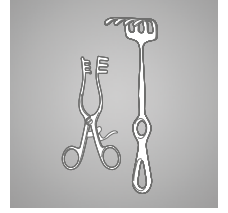
15-921-33-07  
80 x 90 mm

## marTract® Komponenten

marTract® Components  
Componentes marTract®  
Composants marTract®  
Componenti marTract®

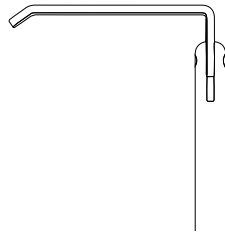
## Wundhaken

Retractors  
Separadores  
Ecarteurs  
Divaricatori

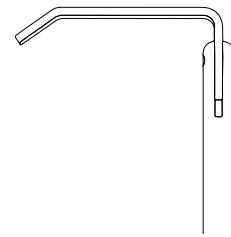


1/2

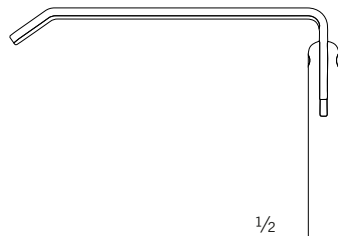
15-921-40-07  
35 x 11 mm



15-921-41-07  
50 x 11 mm



15-921-42-07  
60 x 20 mm



1/2

15-921-43-07  
80 x 20 mm



15-921-44-07  
100 x 20 mm



1/3

Langenbeck  
15-921-40-07 -  
15-921-44-07

Haken  
Retractor  
Gancho  
Crochet  
Divaricatore

15

## marTract® Komponenten

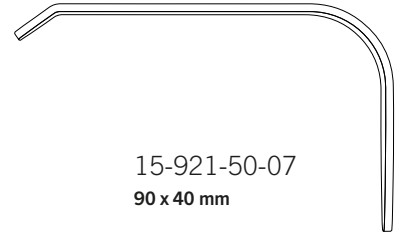
marTract® Components  
Componentes marTract®  
Composants marTract®  
Componenti marTract®



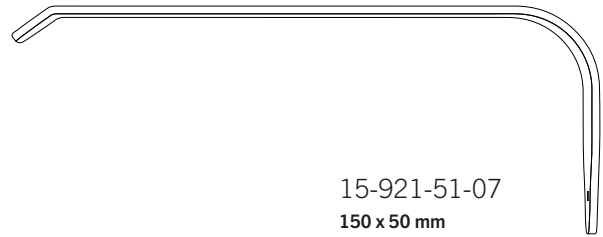
1/3

Langenbeck  
15-921-50-07 -  
15-921-52-07

Blatt  
Blade  
Hoja  
Lame  
Lama



15-921-50-07  
90 x 40 mm



15-921-51-07  
150 x 50 mm



15-921-52-07  
200 x 50 mm

1/2



1/3

15-921-60-07

**175 x 25 mm**

Axilla, Blatt  
Axilla, blade  
Axila, hoja  
Axillaire, lame  
Ascella, lama

## marTract® Komponenten

marTract® Components  
Componentes marTract®  
Composants marTract®  
Componenti marTract®

## Wundhaken

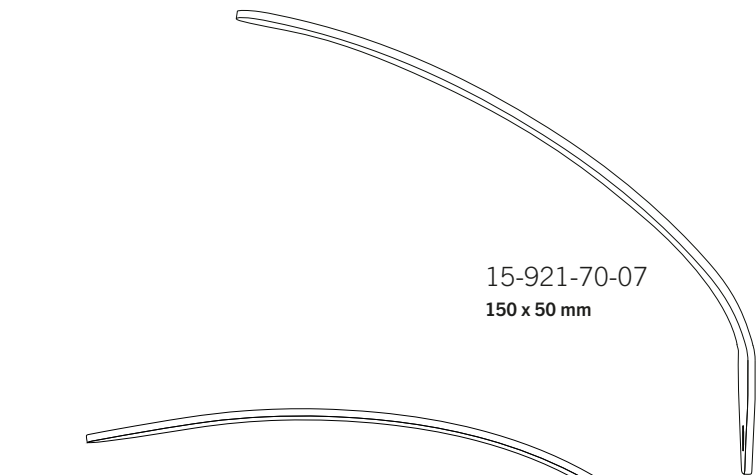
Retractors  
Separadores  
Ecarteurs  
Divaricatori



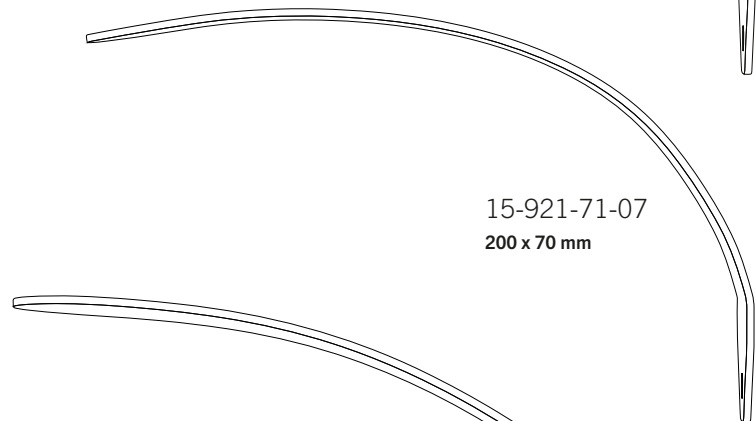
1/3

Deaver  
15-921-70-07  
15-921-72-07

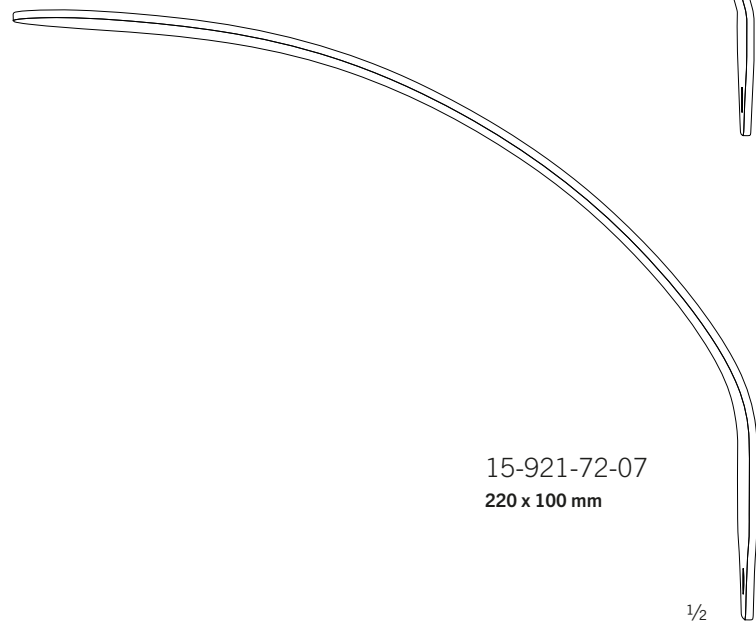
Blatt  
Blade  
Hoja  
Lame  
Lama



15-921-70-07  
150 x 50 mm



15-921-71-07  
200 x 70 mm



15-921-72-07  
220 x 100 mm

1/2



1/3

Deaver  
15-921-80-07  
200 x 70 mm

Haken  
Retractor  
Gancho  
Crochet  
Divaricatore

15

## marTract® Komponenten

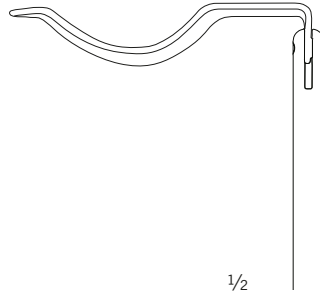
marTract® Components  
Componentes marTract®  
Composants marTract®  
Componenti marTract®



1/3

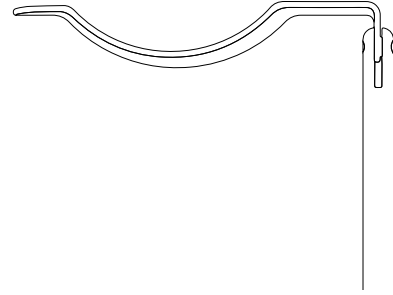
Alan-Parks  
15-921-90-07 -  
15-921-91-07

Haken  
Retractor  
Gancho  
Crochet  
Divaricatore



1/2

15-921-90-07  
75 x 24 mm



15-921-91-07  
95 x 24 mm



1/3

15-922-01-07  
150 x 80 mm

Blase, Blatt, biegsam  
Bladder, blade, flexible  
Vejjga, hoja, flexible  
Vessie, lame, flexible  
Vescica, lama, flessibile

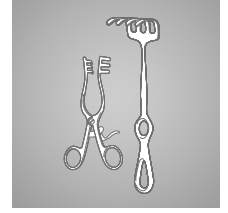


## marTract® Komponenten

marTract® Components  
Componentes marTract®  
Composants marTract®  
Componenti marTract®

## Wundhaken

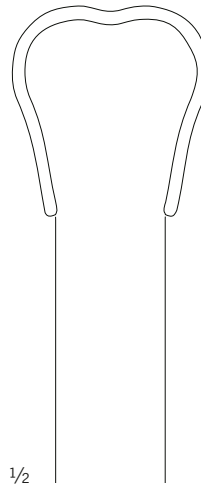
Retractors  
Separadores  
Ecarteurs  
Divaricatori



1/3

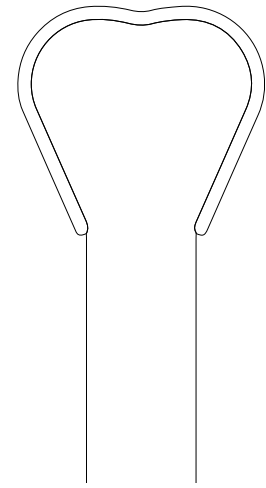
Harrington  
15-922-10-07  
15-922-11-07

Blase, Blatt, biegsam  
Bladder, blade, flexible  
Vejjiga, hoja, flexible  
Vessie, lame, flexible  
Vescica, lama, flessibile



1/2

15-922-10-07  
175 x 50 mm



15-922-11-07  
175 x 65 mm



1/3

Harrington  
15-922-15-07  
50 x 25 mm

Haken  
Retractor  
Gancho  
Crochet  
Divaricatore



1/3

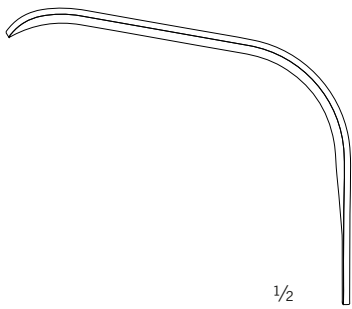
15-922-20-07  
125 x 50 mm

Haken, geschlitzt  
Retractor, slotted  
Gancho, ranurado  
Crochet, fendu  
Divaricatore, fessura

15

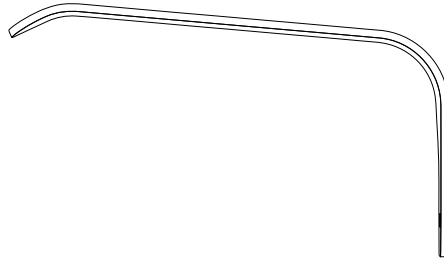
## marTract® Komponenten

marTract® Components  
Componentes marTract®  
Composants marTract®  
Componenti marTract®

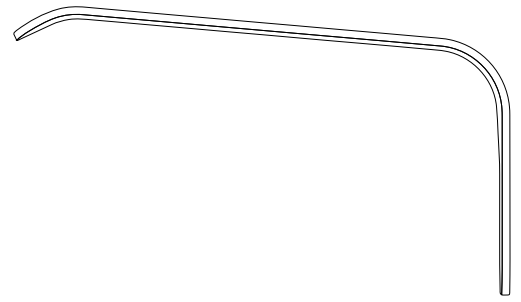


1/2

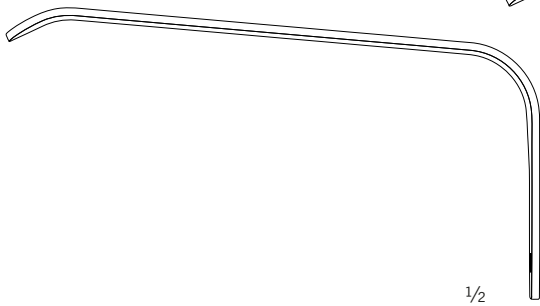
15-922-30-07  
90 x 25 mm



15-922-31-07  
110 x 25 mm

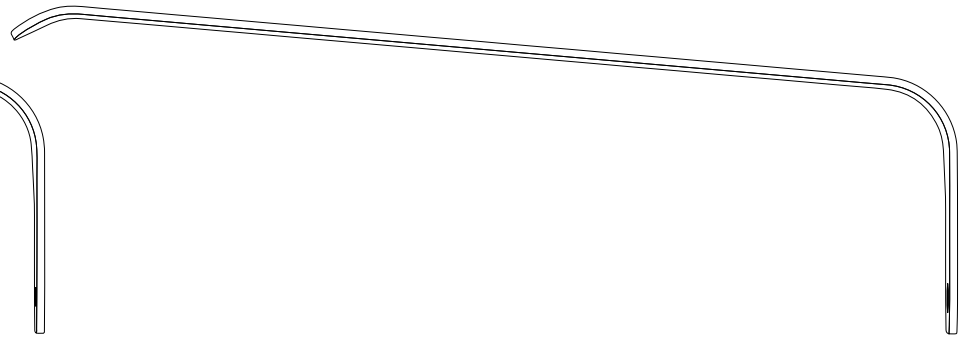


15-922-32-07  
150 x 25 mm



1/2

15-922-33-07  
200 x 25 mm



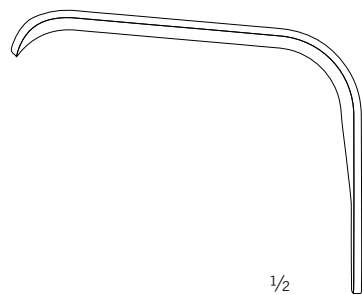
15-922-34-07  
250 x 25 mm



1/3

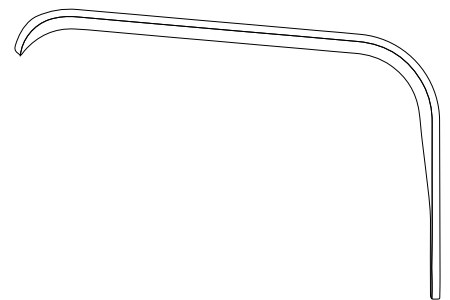
Breisky  
15-922-30-07  
15-922-36-07

Blatt  
Blade  
Hoja  
Lame  
Lama



1/2

15-922-35-07  
90 x 35 mm



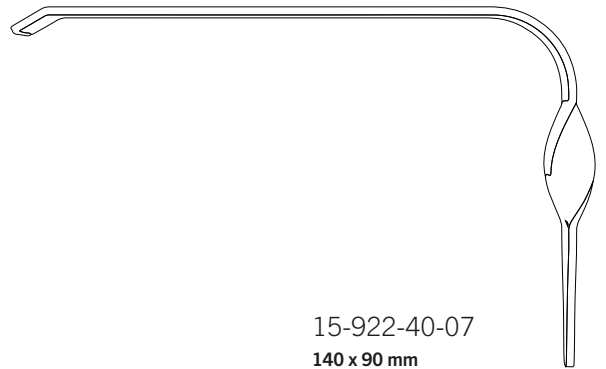
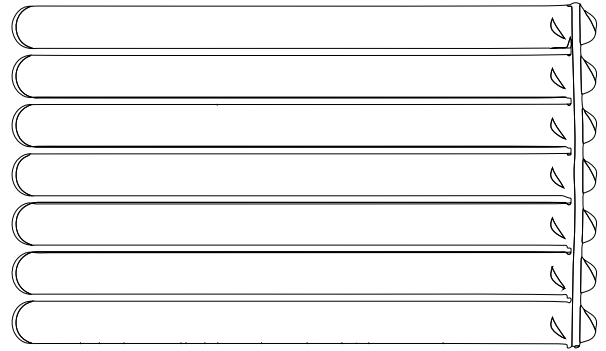
15-922-36-07  
110 x 35 mm

## marTract® Komponenten

marTract® Components  
Componentes marTract®  
Composants marTract®  
Componenti marTract®

## Wundhaken

Retractors  
Separadores  
Écarteurs  
Divaricatori



15-922-40-07  
140 x 90 mm

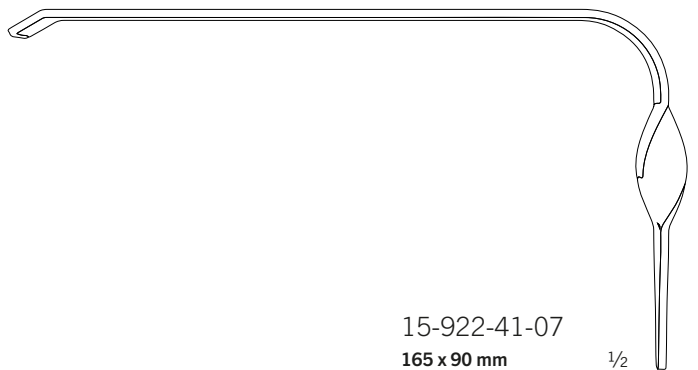
15



1/3

15-922-40-07  
15-922-41-07

Fächer, Blatt, biegsam  
Fan, blade, flexible  
Abanico, hoja, flexible  
Éventail, lame, flexible  
Divaricatore vent, lama, flessibile



15-922-41-07  
165 x 90 mm

1/2

## marTract® Komponenten

marTract® Components  
Componentes marTract®  
Composants marTract®  
Componenti marTract®

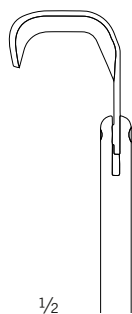
---



$\frac{1}{3}$

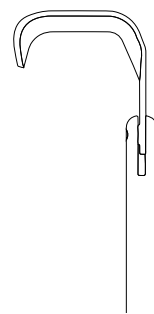
Richardson  
15-922-50-07  
15-922-51-07

Haken  
Retractor  
Gancho  
Crochet  
Divaricatore



$\frac{1}{2}$

15-922-50-07  
25 x 21 mm



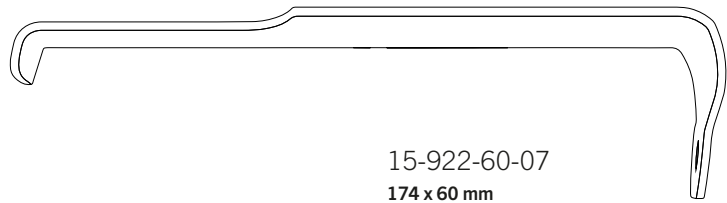
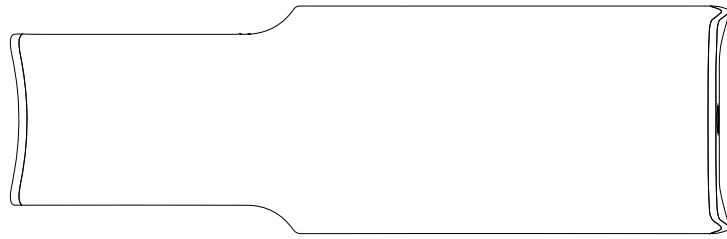
15-922-51-07  
30 x 29 mm

## marTract® Komponenten

marTract® Components  
Componentes marTract®  
Composants marTract®  
Componenti marTract®

## Wundhaken

Retractors  
Separadores  
Ecarteurs  
Divaricatori



15-922-60-07  
174 x 60 mm



15-922-61-07  
270 x 60 mm

1/2



1/3

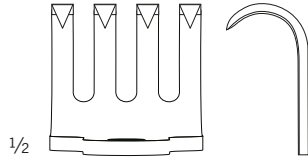
St. Marks  
15-922-60-07  
15-922-61-07

Pelvis, Blatt  
Pelvis, blade  
Pelvis, hoja  
Pelvien, lame  
Pelvi, lama

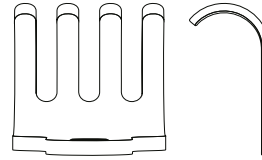
15

**marTract® Komponenten**

marTract® Components  
Componentes marTract®  
Composants marTract®  
Componenti marTract®

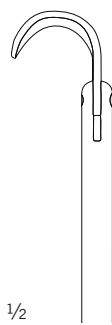


15-922-70-07  
22 x 20 mm  
sharp

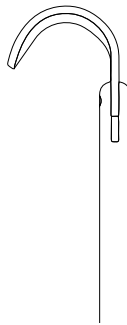


15-922-71-07  
22 x 20 mm  
blunt

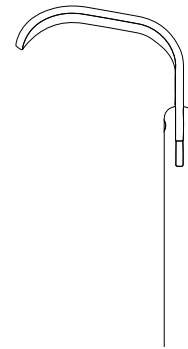
Volkman  
15-922-70-07  
15-922-71-07  
Haken  
Retractor  
Gancho  
Crochet  
Divaricatore



15-922-80-07  
22 x 18 mm



15-922-81-07  
28 x 23 mm



15-922-82-07  
43 x 23 mm

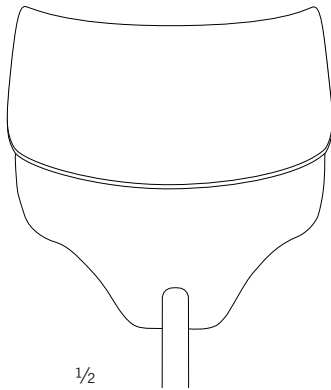
Roux  
15-922-80-07  
15-922-82-07  
Haken  
Retractor  
Gancho  
Crochet  
Divaricatore

## marTract® Komponenten

marTract® Components  
Componentes marTract®  
Composants marTract®  
Componenti marTract®

## Wundhaken

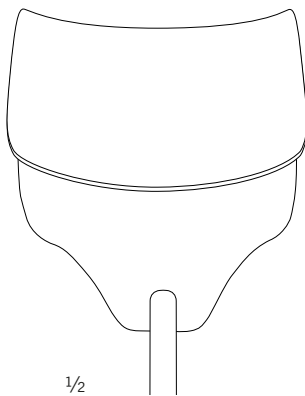
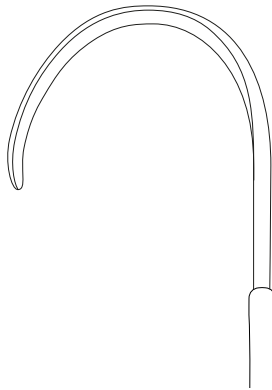
Retractors  
Separadores  
Ecarteurs  
Divaricatori



1/2

15-922-90-07

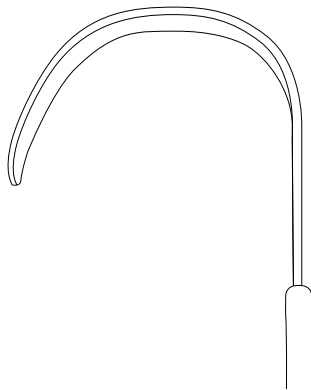
60 x 85 mm



1/2

15-922-91-07

65 x 78 mm



1/3

15-922-90-07

15-922-91-07

Oberbauch, Haken  
Epigastrium, retractor  
Epigastrio, gancho  
Abdomen supérieur, crochet  
Addome super, divaricatore



1/3

15-922-95-07

Laparoskopischer Leberhaken, Größe M  
Laparoscopic liver hooklet / size M  
Ganchito hepático laparoscópico, tamaño M  
Ecarteur laparoscopique, taille M  
Divaricatore laper, misura M

15-922-96-07

Laparoskopischer Leberhaken, Größe L  
Laparoscopic liver hooklet / size L  
Ganchito hepático laparoscópico, tamaño L  
Ecarteur laparoscopique, taille L  
Divaricatore laper, misura L

## **marTract® Wundspreizersystem**

marTract® Retractor System

Sistema retractor marTract®

Système écarteur marTract®

Sistema divaricatore marTract®

Informationen zu Setzusammenstellungen und Indikationen entnehmen Sie bitte der separaten Broschüre:

- marTract® Wundspreizersystem

Please refer to the separate brochure for information on the set configurations and indications:

- marTract® wound spreader system

Para información sobre la composición de los kits y las indicaciones, consulte el folleto específico:

- Sistema de separadores marTract®

Veuillez consulter la brochure séparée pour obtenir des informations relatives aux compositions de sets et aux indications :

- Système d'écarteurs marTract®

Per informazioni relative alla composizione dei set e per le indicazioni, consultare la brochure separata:

- Sistema di divaricatori autostatici marTract®

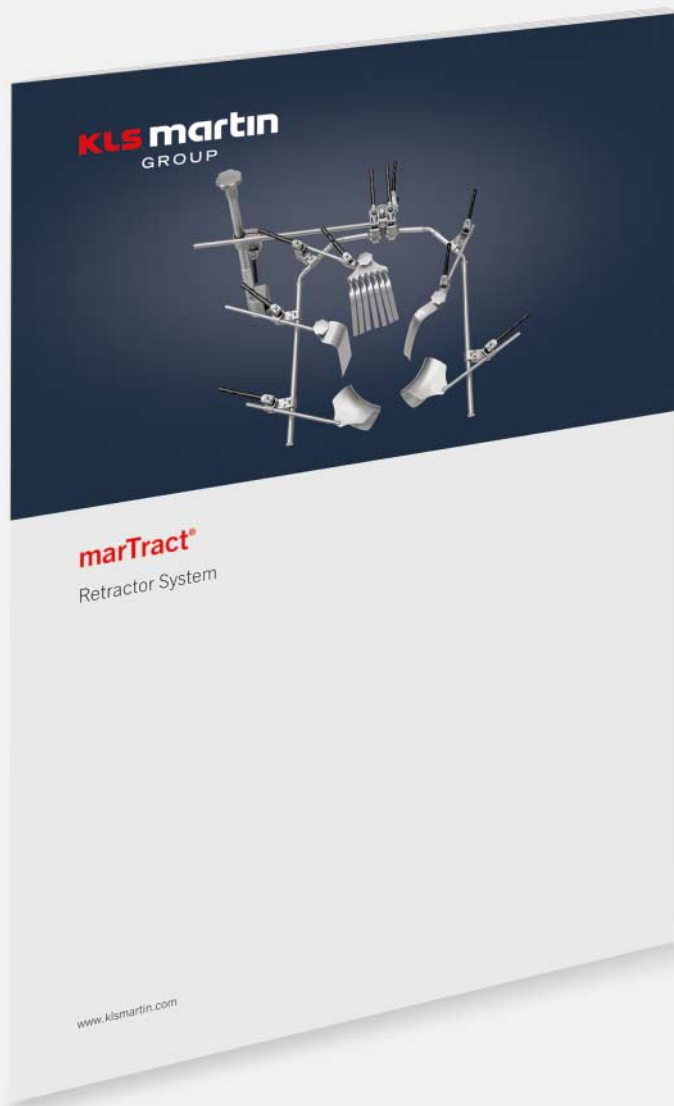


## marTract® Wundspeizersystem

marTract® Retractor System  
Sistema retractor marTract®  
Système écarteur marTract®  
Sistema divaricatore marTract®

## Wundhaken

Retractors  
Separadores  
Ecarteurs  
Divaricatori



## Bauchspatel

Abdominal Spatulas  
Espátulas abdominales  
Spatules abdominales  
Spatole addominali



15-963-01-01  
33 cm / 13 "  
**30 mm**

15-963-02-01  
33 cm / 13 "  
**40 mm**

15-963-03-01  
33 cm / 13 "  
**50 mm**

15-963-01-01 -  
15-963-03-01

biegsam  
malleable  
maleable  
malléable  
malleabili



15-971-00-01  
20 cm / 7 7/8 "  
**16 mm - 25 mm**

15-971-01-01  
28 cm / 11 "  
**25 mm - 30 mm**

15-971-02-01  
30 cm / 11 5/8 "  
**37 mm - 45 mm**

Haberer  
15-971-00-01 -  
15-971-02-01

konische Form  
tapered  
forma cónica  
forme conique  
forma conica



15-975-06-01  
20 cm / 7 7/8 "  
**6,5 mm**

15-975-09-01  
20 cm / 7 7/8 "  
**9,5 mm**

15-975-13-01  
20 cm / 7 7/8 "  
**13 mm**

15-975-16-01  
20 cm / 7 7/8 "  
**16 mm**

15-975-19-01  
20 cm / 7 7/8 "  
**19 mm**

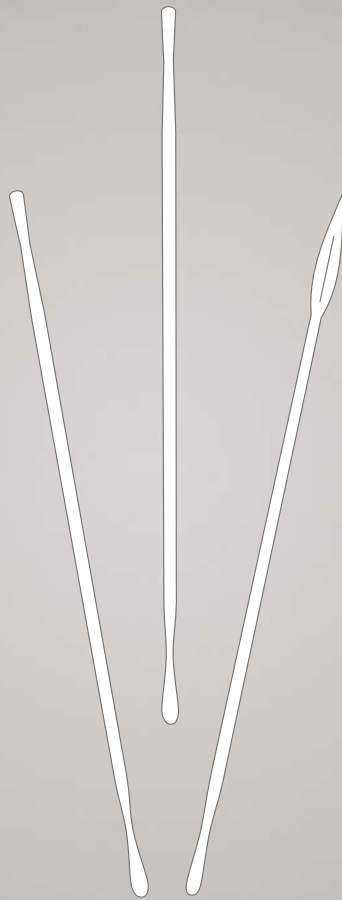
15-975-25-01  
20 cm / 7 7/8 "  
**25 mm**

Martin  
15-975-06-01 -  
15-975-25-01

biegsam, sehr weich  
malleable, very soft  
maleable, muy blando  
malléable, très souple  
malleabili, molto dolci

# 16

Sonden, Watteträger  
Probes, Applicators  
Sondas, Porta-algodones  
Sondes, porte-cotons  
Sonde, portacotoni



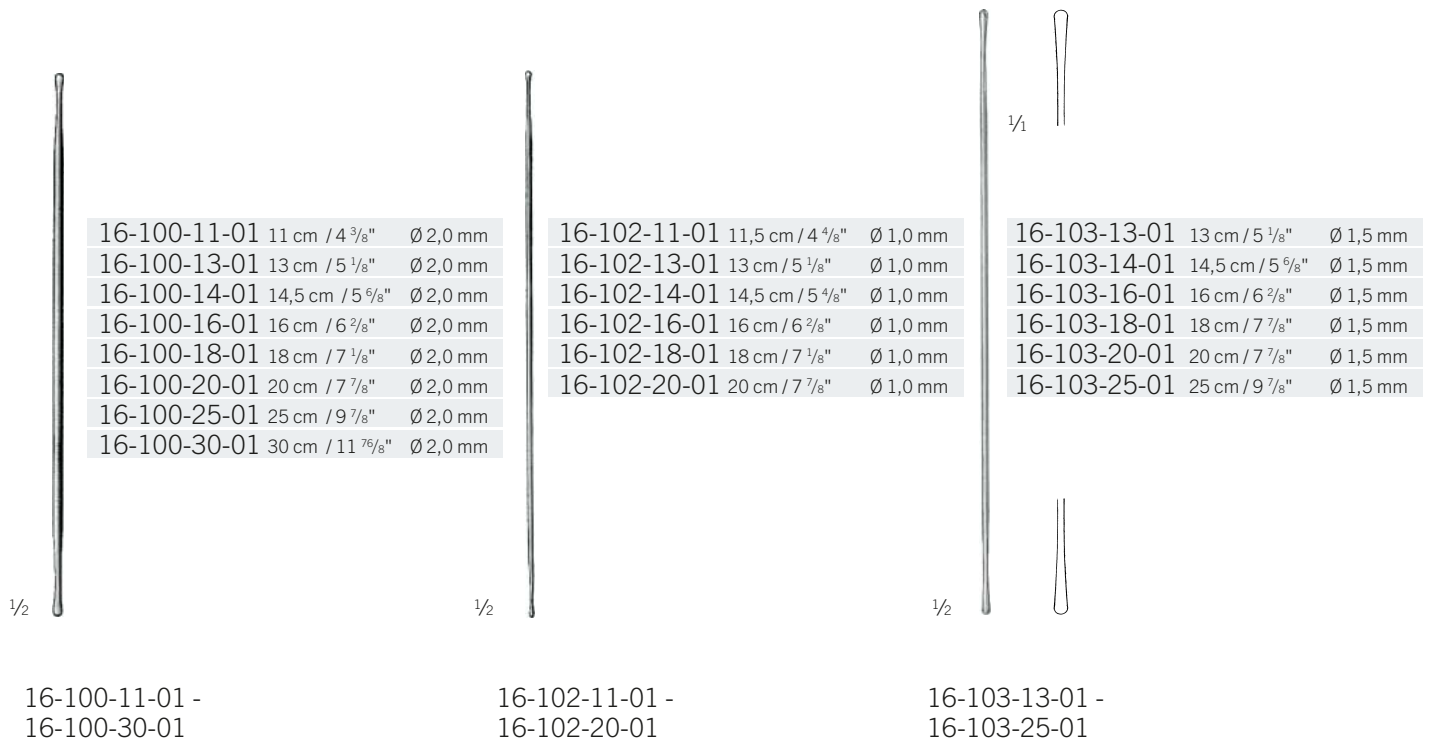
## Knopfsonden

Probes

Sondas abotonadas

Sondes boutonnées

Sonde a bottone



## Hohlsonden, Fistelsonden

Grooved Directors, Fistula Probes

Sondas acanaladas, Sondas para fístula

Sondes cannelées, Sondes pour fistule

Sonde cannellate, Sonde per fistole

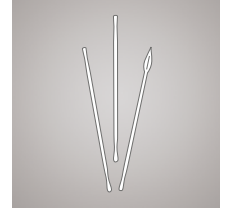
## Sonden, Watteträger

Probes, Applicators

Sondas, Porta-algodones

Sondes, porte-cotons

Sonde, portacotoni



1/2

|              |                   |
|--------------|-------------------|
| 16-160-13-01 | 13 cm / 5 1/8"    |
| 16-160-14-01 | 14,5 cm / 5 9/16" |
| 16-160-16-01 | 16 cm / 6 2/8"    |

16-160-13-01 -  
16-160-16-01



1/2

|              |                   |
|--------------|-------------------|
| 16-170-13-01 | 13 cm / 5 1/8"    |
| 16-170-14-01 | 14,5 cm / 5 9/16" |
| 16-170-16-01 | 16 cm / 6 2/8"    |

16-170-13-01 -  
16-170-16-01



1/2

Doyen  
16-175-14-01  
14,5 cm / 5 9/16"



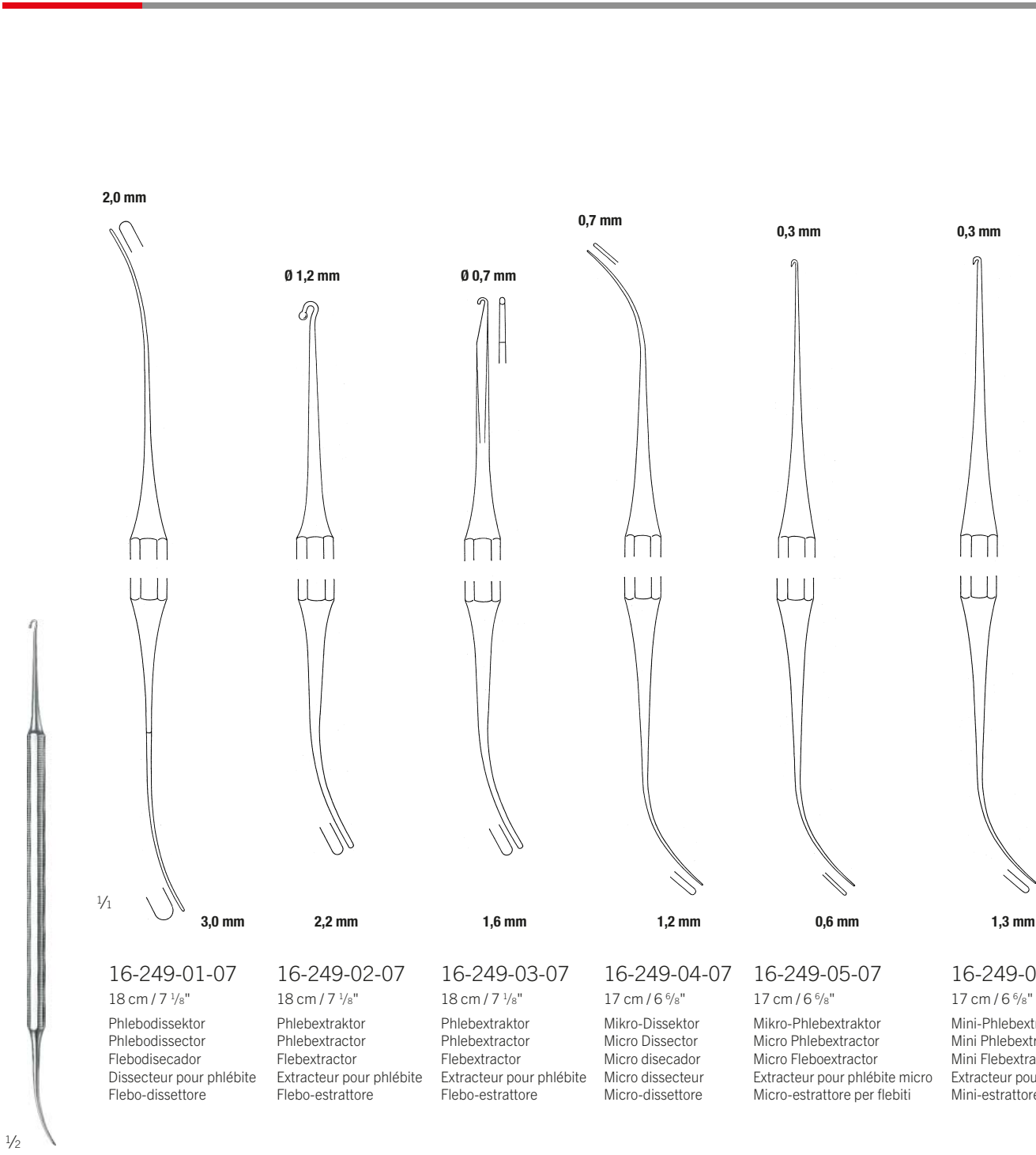
1/2

Nelaton  
16-185-16-01  
16 cm / 6 2/8"

16

# Varizeninstrumente

Varix Instruments  
Instrumentos para varices  
Instruments pour varices  
Strumenti per varici



|  |   |   |  |  |  |
|--|---|---|--|--|--|
| 16-249-01-07<br>18 cm / 7 1/8"   | 16-249-02-07<br>18 cm / 7 1/8"  | 16-249-03-07<br>18 cm / 7 1/8"  | 16-249-04-07<br>17 cm / 6 6/8"   | 16-249-05-07<br>17 cm / 6 6/8"   | 16-249-06-07<br>17 cm / 6 6/8"   |
| Phlebodissektor<br>Phlebodissector<br>Flebodisecador<br>Dissecteur pour phlébite<br>Flebo-dissettore | Phlebextraktor<br>Phlebextractor<br>Flebextractor<br>Extracteur pour phlébite<br>Flebo-estrattore | Phlebextraktor<br>Phlebextractor<br>Flebextractor<br>Extracteur pour phlébite<br>Flebo-estrattore | Mikro-Dissektor<br>Micro Dissector<br>Micro disecador<br>Micro dissector<br>Micro-dissettore | Mikro-Phlebextraktor<br>Micro Phlebextractor<br>Micro Fleboextractor<br>Extracteur pour phlébite micro<br>Micro-estrattore per flebiti | Mini-Phlebextraktor<br>Mini Phlebextractor<br>Mini Flebextractor<br>Extracteur pour phlébite mini<br>Mini-estrattore per flebiti |

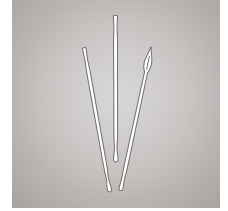
Varady  
16-249-01-07 -  
16-249-06-07

## Varizeninstrumente

Varix Instruments  
Instrumentos para varices  
Instruments pour varices  
Strumenti per varici

## Sonden, Watteträger

Probes, Applicators  
Sondas, Porta-algodones  
Sondes, porte-cotons  
Sonde, portacotoni



1/2

### Nabatoff 16-250-00-01

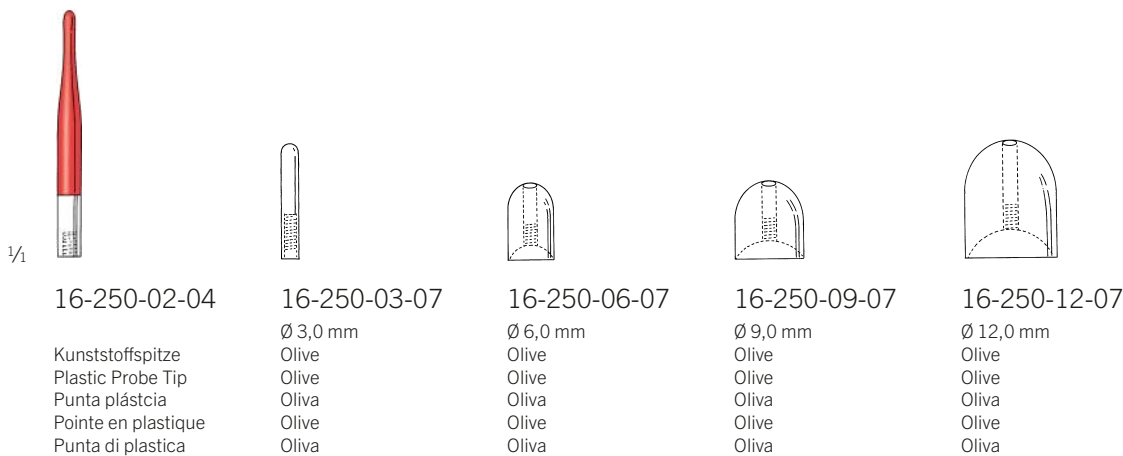
Varizenbesteck  
Varicose Vein Probe Set  
Juego para varices  
Trousse à varices  
Set di sonde per varici

Komplett im marTray, mit Deckel  
Complete in marTray, with lid  
Completo en marTray, con tapa  
Complet sur marTray, avec couvercle  
Completo nel marTray, con coperchio

Set bestehend aus  
set including  
juego compuesto de  
set comprenant  
set costituito da

16-250-02-04  
16-250-03-07  
16-250-06-07  
16-250-09-07  
16-250-12-07  
16-250-80-07  
16-250-90-07

16



1/1

16-250-02-04

Kunststoffspitze  
Plastic Probe Tip  
Punta plástica  
Pointe en plastique  
Punta di plastica

16-250-03-07

Ø 3,0 mm  
Olive  
Olive  
Oliva  
Olive  
Oliva

16-250-06-07

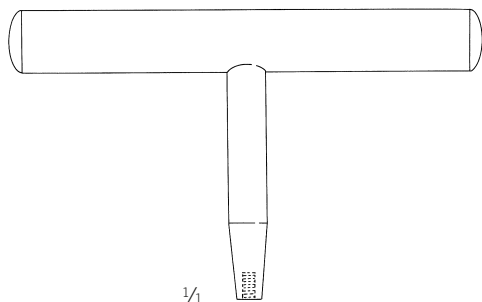
Ø 6,0 mm  
Olive  
Olive  
Oliva  
Olive  
Oliva

16-250-09-07

Ø 9,0 mm  
Olive  
Olive  
Oliva  
Olive  
Oliva

16-250-12-07

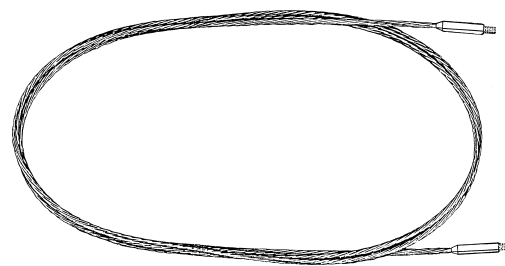
Ø 12,0 mm  
Olive  
Olive  
Oliva  
Olive  
Oliva



1/1

16-250-80-07

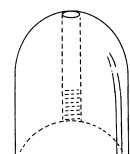
T-Griff  
Handle, T-form  
Mango  
Manche tracteur  
Mango solo



16-250-90-07

Zugseil  
Traction Cable  
Cable de tracción  
Cable tracteur  
Fune di trazione  
**90 cm**

Nicht im Set enthalten  
Not included in the set  
No incluido en el juego  
Non contenu dans le set  
Non contenuto nel set



16-250-15-07

Ø 15,0 mm  
Olive  
Olive  
Oliva  
Olive  
Oliva

## Ringstripper

Ring Strippers  
Fleboextractores  
Strippers à anneau  
Stripper anello



16-251-02-01  
Ø 2,0 mm



16-251-03-01  
Ø 3,0 mm



16-251-04-01  
Ø 4,0 mm



16-251-06-01  
Ø 6,0 mm



16-251-07-01  
Ø 7,0 mm

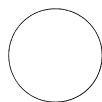


16-251-08-01  
Ø 8,0 mm

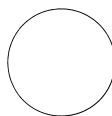


1/1

16-251-10-01  
Ø 10 mm



16-251-12-01  
Ø 12 mm



16-251-14-01  
Ø 14 mm



Vollmar  
16-251-02-01 -  
16-251-14-01  
50 cm / 19 5/8"  
stumpf  
blunt  
romo  
mousse  
smusso

16-251-30-01  
11,5 cm / 4 1/8"

Handgriff für Ringstripper nach Vollmar  
Handle for Vollmar Ring Stripper  
Mango para Vollmar fleboextractor  
Manche pour stripper à anneau selon Vollmar  
Manico per stripper anello di Vollmar"

➔ 16-251-02-01 -  
16-251-14-01

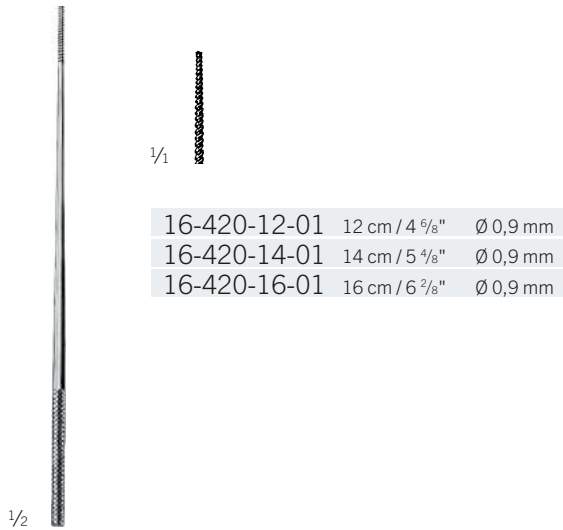
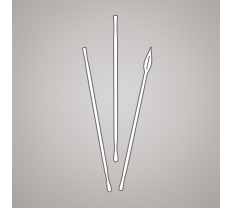


## Watteträger

Cotton Applicators  
Porta algodones  
Porte-cotons  
Portacottone

## Sonden, Watteträger

Probes, Applicators  
Sondas, Porta-algodones  
Sondes, porte-cotons  
Sonde, portacotoni



Farrell  
16-420-12-01 -  
16-420-16-01

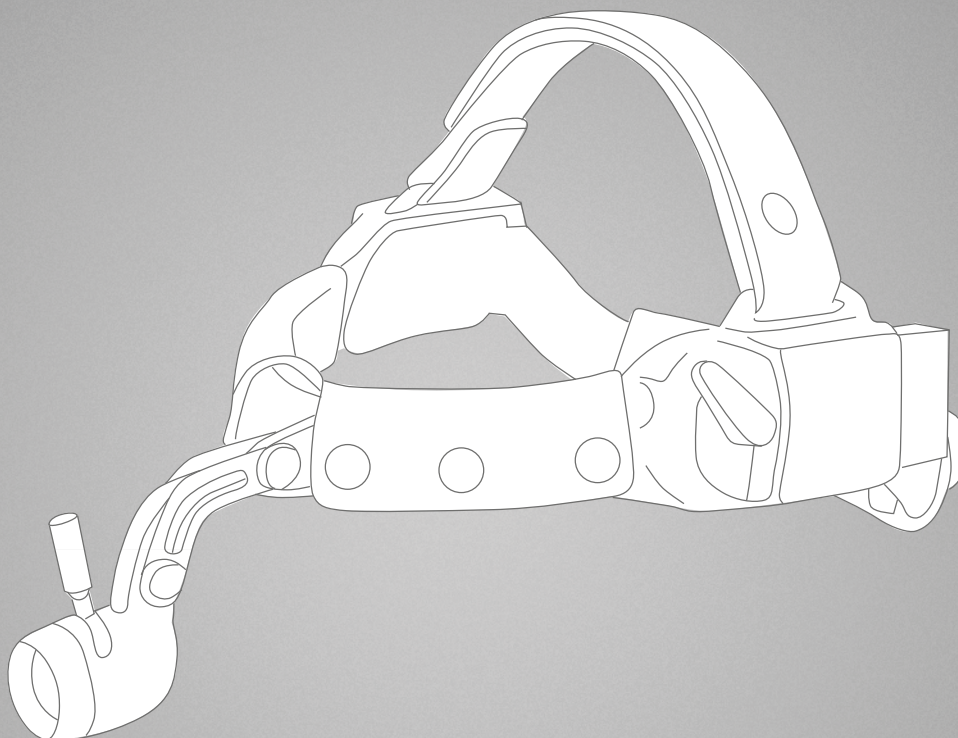


Farrell  
16-425-16-07  
3-kant  
triangular  
triangular  
triangulaires  
triangolare



Diagnostik  
Diagnostics  
Diagnóstico  
Diagnostic  
Diagnostica

# 17



## Spezial-Produkte

Special Products

Produits spéciaux

Prodotti speciali

Productos especiales

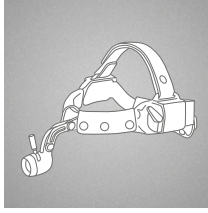
Informationen zu den KLS-Martin-Stirnleuchten entnehmen Sie bitte der separaten Broschüre „MedLED Chrome“.

Please refer to the separate brochure for information about KLS-Martin headlights “MedLED Chrome”.

Encontrará información sobre las lámparas frontal de KLS-Martin en el folletos individual “MedLED Chrome”.

Veillez vous reporter au brochure séparée pour obtenir des informations détaillées relatives aux lampes frontales KL«MedLED Chrome» .

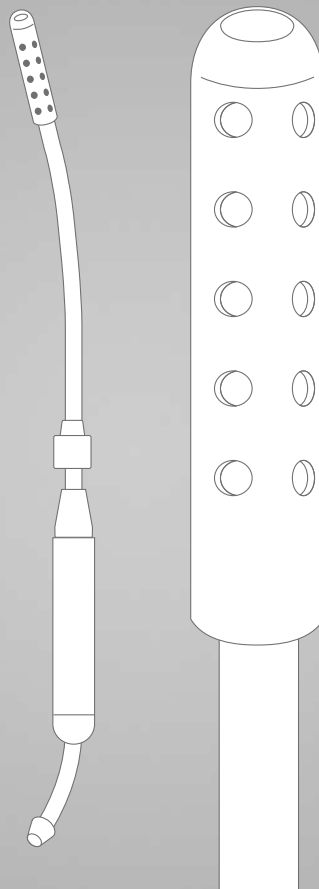
Per informazioni sulle lampada frontale di KLS Martin, consultare le brochure separate KLS Martin “MedLED Chrome”.





# 18

Sauger, Kanülen  
Trocars, Suction Tubes, Cannulas  
Trócares, Tubos de Aspiración, Cánulas  
Trocarts, Tubes d'aspiration, Canules  
Trequarti, Tubi d'aspirazione, Cannule



## Sauger

Suction Tubes

Tubos de aspiración

Tubes d'aspiration

Tubi d'aspirazione



18-510-33-07 -  
18-511-50-07

pädiatrische Sauger, mit perforierter Schraubspitze  
pediatric suction tubes, with perforated screw tip  
tubos de aspiración para niños, con punta perforada y roscada  
tubes d'aspiration pour enfants, avec pointe perforée et fileté  
tubi di aspirazione pediatrici, con punta perforata e filetta

|              |     |                |          |
|--------------|-----|----------------|----------|
| 18-510-33-07 | 45° | 18 cm / 7 1/8" | Ø 3,3 mm |
| 18-510-50-07 |     |                | Ø 5,0 mm |
| 18-511-33-07 | 90° | 16 cm / 6 2/8" | Ø 3,3 mm |
| 18-511-50-07 |     |                | Ø 5,0 mm |

18-512-33-07 -  
18-514-50-07

pädiatrische Sauger  
pediatric suction tubes  
tubos de aspiración para niños  
tubes d'aspiration pour enfants  
tubi di aspirazione

|              |     |                |          |
|--------------|-----|----------------|----------|
| 18-512-33-07 | 45° | 21 cm / 8 2/8" | Ø 3,3 mm |
| 18-512-50-07 |     |                | Ø 5,0 mm |
| 18-513-33-07 | 60° | 18 cm / 7 1/8" | Ø 3,3 mm |
| 18-513-50-07 |     |                | Ø 5,0 mm |
| 18-514-33-07 | 90° | 15 cm / 5 7/8" | Ø 3,3 mm |
| 18-514-50-07 |     |                | Ø 5,0 mm |

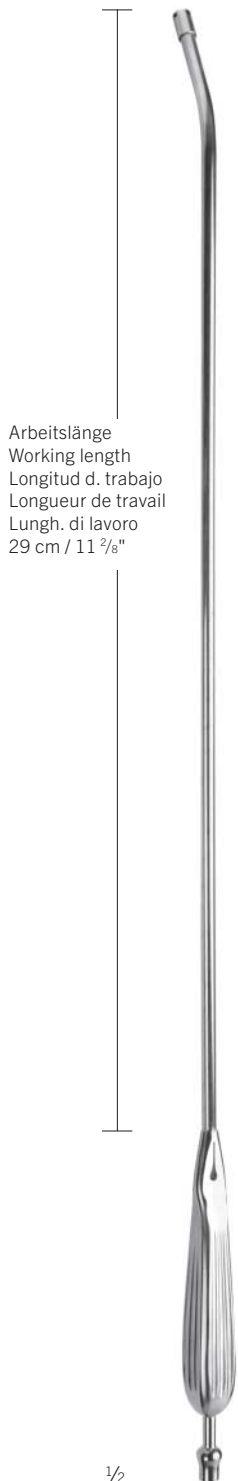
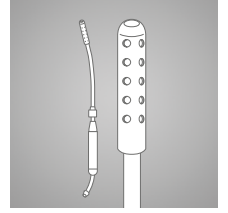


## Sauger

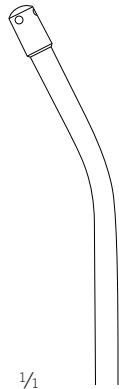
Suction Tubes  
Tubos de aspiración  
Tubes d'aspiration  
Tubi d'aspirazione

## Sauger, Kanülen

Suction Tubes, Cannulas  
Tubos de Aspiración, Cánulas  
Tubes d'aspiration, Canules  
Tubi d'aspirazione, Cannule



Arbeitslänge  
Working length  
Longitud d. trabajo  
Longueur de travail  
Lungh. di lavoro  
29 cm / 11 <sup>2</sup>/<sub>8</sub>"



1/4

18-515-60-07

Sauger  
Suction Tubes  
Tubos de aspiración  
Tubes d'aspiration  
Tubi d'aspirazione

18-516-60-07

MIC-Sauger mit Saugunterbrecher  
MIS Suction cannulas with suction stop  
Cánulas de aspiración CMI con interrupción de succión  
Canules d'aspiration CMI avec interruption de l'aspiration  
Cannule di aspirazione CMI con arresto aspirazione

1/2

**Ø 6 mm**

18-515-60-07 -  
18-516-60-07  
39 cm / 15 <sup>2</sup>/<sub>8</sub>"



1/4

18-517-01-07

4,5 cm

Ventrikularauslass  
Ventricular vent  
Salida ventricular  
Sortie ventriculaire  
Sfiato ventricolare

## Sauger

Suction Tubes

Tubos de aspiración

Tubes d'aspiration

Tubi d'aspirazione



1/2

|              | Arbeitslänge<br>working length<br>largo útil<br>longueur utile<br>lunghezza utile |          |
|--------------|---|----------|
| 18-521-31-01 | 200 mm  | Ø 3,0 mm |
| 18-521-21-01 | 200 mm  | Ø 4,0 mm |
| 18-521-51-01 | 200 mm  | Ø 5,0 mm |



1/2

Ø 3,3 mm  
Frazier  
18-522-10-01  
24 cm / 9 4/8"



1/2

Frazier  
18-523-06-01 -  
18-523-13-01  
19,5 cm / 7 5/8"

|              | Arbeitslänge<br>working length<br>largo útil<br>longueur utile<br>lunghezza utile |          |
|--------------|---|----------|
| 18-523-06-01 | 130 mm  | Ø 2,0 mm |
| 18-523-07-01 | 130 mm  | Ø 2,3 mm |
| 18-523-08-01 | 130 mm  | Ø 2,7 mm |
| 18-523-09-01 | 130 mm  | Ø 3,0 mm |
| 18-523-10-01 | 130 mm  | Ø 3,3 mm |
| 18-523-11-01 | 130 mm  | Ø 3,6 mm |
| 18-523-12-01 | 130 mm  | Ø 4,0 mm |
| 18-523-13-01 | 130 mm  | Ø 5,0 mm |

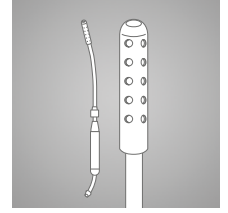
Adson  
18-521-21-01 -  
18-521-51-01  
20 cm / 7 7/8"

## Sauger

Suction Tubes  
Tubos de aspiración  
Tubes d'aspiration  
Tubi d'aspirazione

## Sauger, Kanülen

Suction Tubes, Cannulas  
Tubos de Aspiración, Cánulas  
Tubes d'aspiration, Canules  
Tubi d'aspirazione, Cannule



1/2

Fergusson  
18-524-15-01 -  
18-524-50-01  
18 cm / 7 1/8"

|              | Arbeitslänge<br>working length<br>largo útil<br>longueur utile<br>lunghezza utile |          |
|--------------|---|----------|
| 18-524-15-01 | 110 mm  | Ø 1,5 mm |
| 18-524-20-01 | 110 mm  | Ø 2,0 mm |
| 18-524-25-01 | 110 mm  | Ø 2,5 mm |
| 18-524-30-01 | 110 mm  | Ø 3,0 mm |
| 18-524-40-01 | 110 mm  | Ø 4,0 mm |
| 18-524-50-01 | 110 mm  | Ø 5,0 mm |



1/2

Fergusson  
18-524-60-01 -  
18-524-65-01

|              | Arbeitslänge<br>working length<br>largo útil<br>longueur utile<br>lunghezza utile |          |
|--------------|---|----------|
| 18-524-60-01 | 130 mm  | Ø 1,5 mm |
| 18-524-61-01 | 130 mm  | Ø 2,0 mm |
| 18-524-62-01 | 130 mm  | Ø 2,5 mm |
| 18-524-63-01 | 130 mm  | Ø 3,0 mm |
| 18-524-64-01 | 130 mm  | Ø 4,0 mm |
| 18-524-65-01 | 130 mm  | Ø 5,0 mm |

## Sauger

Suction Tubes

Tubos de aspiración

Tubes d'aspiration

Tubi d'aspirazione



|              | Arbeitslänge<br>working length<br>largo útil<br>longueur utile<br>lunghezza utile |          |
|--------------|---|----------|
| 18-524-70-01 | 160 mm  | Ø 1,5 mm |
| 18-524-71-01 | 160 mm  | Ø 2,0 mm |
| 18-524-72-01 | 160 mm  | Ø 2,5 mm |
| 18-524-73-01 | 160 mm  | Ø 3,0 mm |
| 18-524-74-01 | 160 mm  | Ø 4,0 mm |
| 18-524-75-01 | 160 mm  | Ø 5,0 mm |

1/2

Fergusson  
18-524-70-01 -  
18-524-75-01



|              | Arbeitslänge<br>working length<br>largo útil<br>longueur utile<br>lunghezza utile |          |
|--------------|---|----------|
| 18-524-80-01 | 200 mm  | Ø 1,5 mm |
| 18-524-81-01 | 200 mm  | Ø 2,0 mm |
| 18-524-82-01 | 200 mm  | Ø 2,5 mm |
| 18-524-83-01 | 200 mm  | Ø 3,0 mm |
| 18-524-84-01 | 200 mm  | Ø 4,0 mm |
| 18-524-85-01 | 200 mm  | Ø 5,0 mm |

1/2

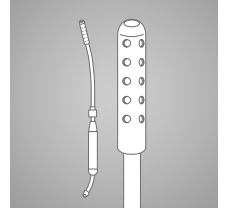
Fergusson  
18-524-80-01 -  
18-524-85-01

## Sauger

Suction Tubes  
Tubos de aspiración  
Tubes d'aspiration  
Tubi d'aspirazione

## Sauger, Kanülen

Suction Tubes, Cannulas  
Tubos de Aspiración, Cánulas  
Tubes d'aspiration, Canules  
Tubi d'aspirazione, Cannule



1/2

Poppen  
18-525-06-01 -  
18-525-12-01

|              | Arbeitslänge<br>working length<br>largo útil<br>longueur utile<br>lunghezza utile |          |
|--------------|---|----------|
| 18-525-06-01 | 90 mm   | Ø 2,0 mm |
| 18-525-08-01 | 90 mm   | Ø 2,6 mm |
| 18-525-10-01 | 90 mm   | Ø 3,3 mm |
| 18-525-12-01 | 90 mm   | Ø 4,0 mm |

## Sauger, Saugrohre

Suction cannulas, Suction Tubes

Cánulas de aspiración, Tubos de aspiración

Canules d'aspiration, Tubes d'aspiration

Cannule di' aspirazione, Tubi di aspirazione



1/2



1/2

|              | Saugaufsatz<br>Suction tip<br>Punta de succión<br>Pointe de succion<br>Punta per aspirazione |
|--------------|--|
| 18-526-05-01 | Ø 0,5 mm   |
| 18-526-07-01 | Ø 0,7 mm   |
| 18-526-09-01 | Ø 0,9 mm   |
| 18-526-12-01 | Ø 1,2 mm   |

Zoellner

18-526-00-01

Saugkanüle, allein  
Suction cannula, only  
Tubo de aspiración, solo  
Tube d'aspiration, seul  
Tubo di aspirazione, solo

Zoellner

18-526-17-01

Saugspitze  
suction tip  
punta de succión  
pointe de succion  
punta per aspirazione



18-526-00-01



1/2



1/1

|              | Saugaufsatz<br>Suction tip<br>Punta de succión<br>Pointe de succion<br>Punta per aspirazione |
|--------------|--|
| 18-527-04-01 | Ø 0,4 mm   |
| 18-527-06-01 | Ø 0,6 mm   |
| 18-527-08-01 | Ø 0,8 mm   |

Ø 2,3 mm

Wullstein

18-527-00-01

14 cm / 5 4/8"

komplett mit Griff und drei Aufsätzen  
complete, with handle and 3 tips  
completo, con mango y 3 puntas  
complet, avec manche et 3 pointes  
completo, con manico e 3 punte

18-527-04-01 - 18-527-08-01

4,5 cm / 1 6/8"

Mikro-Saugkanüle  
Micro suction cannula  
Micro-tubo de aspiración  
Micro-tube d'aspiration  
Micro-tubo di aspirazione



18-527-00-01



1/2

Ø 2,5 mm

Wullstein

18-527-01-01

14 cm / 5 4/8"

Handgriff mit Rohr, allein  
Handle with tube, only  
Mango con tubo, solo  
Manche avec tube, seul  
Manico con tubo, solo

## Sauger, Saugrohre

Suction cannulas, Suction Tubes

Cánulas de aspiración, Tubos de aspiración

Canules d'aspiration, Tubes d'aspiration

Cannule di'aspirazione, Tubi di aspirazione

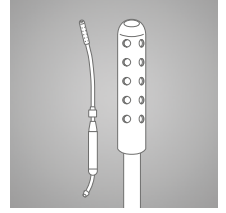
## Sauger, Kanülen

Suction Tubes, Cannulas

Tubos de Aspiración, Cánulas

Tubes d'aspiration, Canules

Tubi d'aspirazione, Cannule



1/2

|              | Arbeitslänge<br>working length<br>largo útil<br>longueur utile<br>lunghezza utile |          |
|--------------|---|----------|
| 18-528-10-01 | 75 mm   | Ø 1,0 mm |
| 18-528-15-01 | 75 mm   | Ø 1,5 mm |
| 18-528-20-01 | 75 mm   | Ø 2,0 mm |

## Baron-Schuknecht

18-528-10-01 -

18-528-20-01

mit Unterbrecher  
with finger cut-off

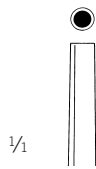
con placa interruptor

avec plaque interrupteur

con placa interruttore



1/2

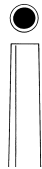


**Ø 3,0 mm**  
18-529-30-07

16,5 cm / 6 4/8"

Arbeitslänge  
working length  
largo útil  
longueur utile  
lunghezza utile

**110 mm**



**Ø 3,5 mm**  
18-529-35-07

16,5 cm / 6 4/8"

Arbeitslänge  
working length  
largo útil  
longueur utile  
lunghezza utile

**110 mm**



**Ø 4,5 mm**  
18-529-45-07

18 cm / 7 1/8"

Arbeitslänge  
working length  
largo útil  
longueur utile  
lunghezza utile

**130 mm**



1/2

## Luer

18-529-30-07 -

18-529-45-07

konisch  
conical  
cónico  
conique  
conico

18-531-01-07

Saughandgriff für Tonsillenkanüle

Suction handle for tonsil cannula

Mango de aspiración para  
cánula para amígdalas

Poignée d'aspiration pour  
aiguille pour amygdales

Impugnatura di aspirazione  
per cannula per tonsille

➔ 18-640-20-07,  
18-641-20-07,  
18-642-20-07

## Sauger, Saugrohre

Suction Tubes, Suction Tubes

Tubos de aspiración, Tubos de aspiración

Canules d'aspiration, Tubes d'aspiration

Cannula d'aspirazione, Tubi d'aspirazione



1/2

**Ø 3,2 mm**  
Landolt  
18-533-01-07

25 cm / 9 7/8"

Sauger für Hypophyse  
Suction tube for pituitary  
Aspirador para pituitaria  
Tube d'aspiration pour hypophyse  
Tubo di aspirazione per ipofisi



1/2

Cerullo  
18-535-00-07

Saugventil  
Suction valve  
Válvula de aspiración  
Vanne d'aspiration  
Valvola di aspirazione



1/2

Yasargil  
18-540-15-01 -  
18-540-35-01

17 cm / 6 5/8"

|              | Arbeitslänge<br>working length<br>largo útil<br>longueur utile<br>lunghezza utile |          |
|--------------|---|----------|
| 18-540-15-01 | 150 mm  | Ø 1,5 mm |
| 18-540-20-01 | 150 mm  | Ø 2,0 mm |
| 18-540-25-01 | 150 mm  | Ø 2,5 mm |
| 18-540-35-01 | 150 mm  | Ø 3,5 mm |

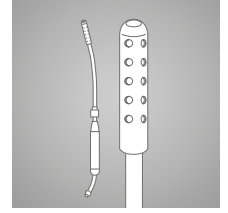


## Sauger

Suction Tubes  
Tubos de aspiración  
Tubes d'aspiration  
Tubi d'aspirazione

## Sauger, Kanülen

Suction Tubes, Cannulas  
Tubos de Aspiración, Cánulas  
Tubes d'aspiration, Canules  
Tubi d'aspirazione, Cannule



1/2

1/2

1/2

1/2

1/2

**Ø 8,0 mm**  
Baby-Yankauer  
18-542-21-01  
21 cm / 8 2/8"

**Ø 9,4 mm**  
Yankauer  
18-543-27-01  
31 cm / 12 2/8"  
komplett, mit Saugspitze  
und Schlaucholive  
complete, with suction tip  
and connector  
completo, con punta de succión  
et raccord  
complet, avec pointe de succion  
et raccord  
completi, con punte d'aspirazione  
e raccordo

**Ø 4,0 mm**  
De Bakey-Adson  
18-544-16-07  
16 cm / 6 2/8"

**Ø 4,0 mm**  
De Bakey-Adson  
18-544-20-07  
20 cm / 7 7/8"

**Ø 9,0 mm**  
De Bakey-Adson  
18-544-28-07  
28 cm / 6 2/8"

18

## Sauger

Suction Tubes

Tubos de aspiración

Tubes d'aspiration

Tubi d'aspirazione



1/2

Ø 2,5 mm

Fig. 0

18-545-10-01

10 cm / 3 7/8"

Ø 3,4 mm

Fig. 1

18-545-11-01

10 cm / 3 7/8"

Ø 4,3 mm

Fig. 2

18-545-12-01

10 cm / 3 7/8"

Ø 6,0 mm

Fig. 3

18-545-13-01

13,5 cm / 5 3/8"

1/2

1/2

1/2

1/2

## Yankauer

18-545-00-01

31 cm / 12 2/8"

komplett, mit Griff, 4 Saugrohren Fig. 0/1/2/3, Saugspitze und Schlaucholive

complete, with handle, 4 tubes fig. 0/1/2/3, suction tip and tube connector

completo, con mango, 4 tubos, fig. 0/1/2/3, punta de succión y conector para tubos

complet, avec manche, 4 tubes, fig. 0/1/2/3, pointe de succion et raccord ou tubes

completi, con manico, 4 tubi, fig. 0/1/2/3, punta per aspirazione e raccordo per tubi

18-545-00-01

Set bestehend aus:

Set consisting of:

Juego formado por:

Set composé de:

Set composto da:

18-545-01-01

18-545-02-01

18-545-10-01

18-545-11-01

18-545-12-01

18-545-13-01

18-545-15-01

18-545-01-01

15 cm / 5 7/8"

Handgriff

Handle

Mango

Manche

Manico

18-545-02-01

2,5 cm / 1"

Schlaucholive

Olive

Oliva

Olive

Oliva

9,9 mm

18-545-15-01

Saugspitze

suction tip

punta de succión

pointe de succion

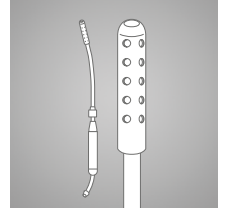
punta per aspirazione

## Sauger

Suction Tubes  
Tubos de aspiración  
Tubes d'aspiration  
Tubi d'aspirazione

## Sauger, Kanülen

Suction Tubes, Cannulas  
Tubos de Aspiración, Cánulas  
Tubes d'aspiration, Canules  
Tubi d'aspirazione, Cannule



1/2

Baby-Poole  
18-548-19-01  
19 cm / 7 4/8"  
**Ø 6 mm**



1/2

Baby-Poole  
18-549-19-01  
19 cm / 7 4/8"  
**Ø 6 mm**



1/2

Poole  
18-550-22-01  
24 cm / 9 4/8"  
**Ø 10 mm**



1/2

Poole  
18-551-22-01  
25 cm / 9 7/8"  
**Ø 8 mm**

## Sauger

Suction Tubes

Tubos de aspiración

Tubes d'aspiration

Tubi d'aspirazione



1/2

|              | Saugrohr<br>Suction tube<br>Tubo de aspiración<br>Tube d'aspiration<br>Tubo di aspirazione | Spülrohr<br>Irrigation tube<br>Tubo de irrigación<br>Tube d'irrigation<br>Tubo d'irrigazione |
|--------------|--|--|
| 18-553-09-07 | <b>Ø 0,9 mm</b>  | <b>Ø 0,7 mm</b>  |
| 18-554-09-07 | <b>Ø 1,2 mm</b>  | <b>Ø 0,9 mm</b>  |
| 18-555-09-07 | <b>Ø 1,5 mm</b>  | <b>Ø 1,2 mm</b>  |



1/2

House  
18-553-09-07 -  
18-555-09-07

17 cm / 6 5/8"

Saugrohr  
Suction tube  
Tubo de aspiración  
Tube d'aspiration  
Tubo di aspirazione

House  
18-556-06-07

4,5 cm / 1 5/8"

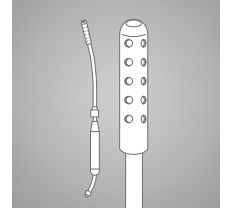
Saugadapter  
Suction adapter  
Adaptador de aspiración  
Adaptateur d'aspiration  
Adattatore di aspirazione

## Sauger

Suction Tubes  
Tubos de aspiración  
Tubes d'aspiration  
Tubi d'aspirazione

## Sauger, Kanülen

Suction Tubes, Cannulas  
Tubos de Aspiración, Cánulas  
Tubes d'aspiration, Canules  
Tubi d'aspirazione, Cannule



1/2

Cooley  
18-561-35-01  
36 cm / 14 1/8"

**Ø 8 mm**



1/2

Cooley  
18-563-31-01  
31 cm / 12 2/8"

**Ø 10 mm**

mit perforierter Schraubspitze  
with perforated screw tip  
con punta perforada y roscada  
avec pointe perforée et fileté  
con punta perforata e filetta



1/2

Cooley  
18-565-30-01  
31 cm / 12 2/8"

**Ø 7 mm**

mit perforierter Schraubspitze  
with perforated screw tip  
con punta perforada y roscada  
avec pointe perforée et fileté  
con punta perforata e filetta



1/2

Cooley  
18-567-33-01  
36 cm / 14 1/8"

**Ø 8 mm**

mit perforierter Schraubspitze  
with perforated screw tip  
con punta perforada y roscada  
avec pointe perforée et fileté  
con punta perforata e filetta

## Sauger

Suction Tubes

Tubos de aspiración

Tubes d'aspiration

Tubi d'aspirazione



1/2

18-568-28-07

28 cm / 11"

**Ø 6 mm**

mit perforierter Schraubspitze  
with perforated screw tip  
con punta perforada y roscada  
avec pointe perforée et filetée  
con punta perforata e filetta



1/2

18-568-30-07

30 cm / 11 6/8"

**Ø 6 mm**

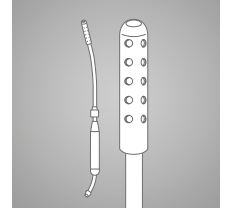
mit perforierter Schraubspitze  
with perforated screw tip  
con punta perforada y roscada  
avec pointe perforée et filetée  
con punta perforata e filetta

## Sauger

Suction Tubes  
Tubos de aspiración  
Tubes d'aspiration  
Tubi d'aspirazione

## Sauger, Kanülen

Suction Tubes, Cannulas  
Tubos de Aspiración, Cánulas  
Tubes d'aspiration, Canules  
Tubi d'aspirazione, Cannule



1/2

Nuboer  
18-569-21-01  
21 cm / 8 2/8"

**Ø 6 mm**  
runde Öffnung  
round opening  
abertura redonda  
ouverture ronde  
apertura rotonda



1/2

Nuboer  
18-571-21-01  
21 cm / 8 2/8"

**Ø 6 mm**  
ovale Öffnung  
oval opening  
abertura ovalada  
ouverture ovale  
apertura ovale



1/2

Jamieson  
18-572-05-07 -  
18-572-15-07  
27 cm / 10 5/8"

|              |                 |
|--------------|-----------------|
| 18-572-05-07 | <b>Ø 0,5 mm</b> |
| 18-572-10-07 | <b>Ø 1,0 mm</b> |
| 18-572-15-07 | <b>Ø 1,5 mm</b> |



1/2

Jamieson  
18-573-05-07 -  
18-573-10-07  
27 cm / 10 5/8"

|              |                 |
|--------------|-----------------|
| 18-573-05-07 | <b>Ø 0,5 mm</b> |
| 18-573-10-07 | <b>Ø 1,0 mm</b> |

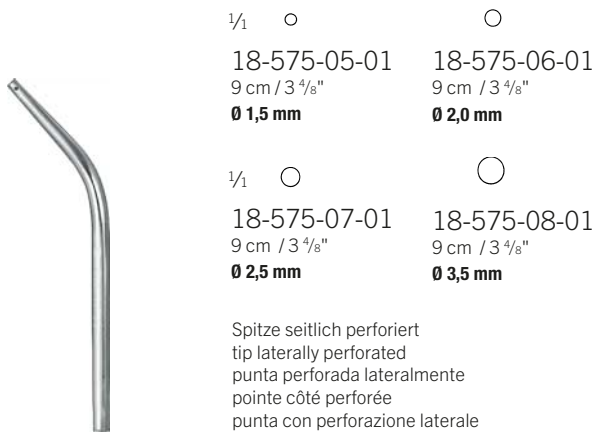
## Sauger, Saugrohre

Suction Tubes

Tubos de aspiración

Tubes d'aspiration

Tubi d'aspirazione



1/1 ○

18-575-05-01

9 cm / 3 4/8"

Ø 1,5 mm

○

18-575-06-01

9 cm / 3 4/8"

Ø 2,0 mm

1/1 ○

18-575-07-01

9 cm / 3 4/8"

Ø 2,5 mm

○

18-575-08-01

9 cm / 3 4/8"

Ø 3,5 mm

Spitze seitlich perforiert  
tip laterally perforated  
punta perforada lateralmente  
pointe côté perforée  
punta con perforazione laterale



18-575-24-01



1/2

Coupland  
18-575-24-01

17 cm / 6 5/8"

Handgriff mit Schlauchansatz  
Handle with connector  
Mango con conexión para tubos  
Manche avec connection pour tubes  
Manico con raccordo per tubi



1/2

Byrd  
18-577-01-01 -  
18-577-03-01

21,5 cm / 8 1/8"

○

18-577-01-01

Ø 3,0 mm

○

18-577-02-01

Ø 3,5 mm

1/1 ○

18-577-03-01

Ø 4,3 mm



1/2

Cogswell  
18-579-23-01

24,5 cm / 9 5/8"

Ø 3,8 mm  
mit Unterbrecher  
with finger cut-off  
con placa desconectadona  
avec plaque interrupteur  
con placa interruttore



## Führungsnadeln

Guide Needles

Agujas de guía

Aiguilles d'introduction

Aghi conduttori

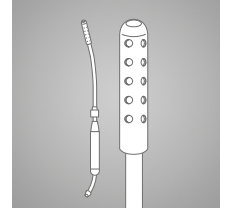
## Sauger, Kanülen

Suction Tubes, Cannulas

Tubos de Aspiración, Cánulas

Tubes d'aspiration, Canules

Tubi d'aspirazione, Cannule



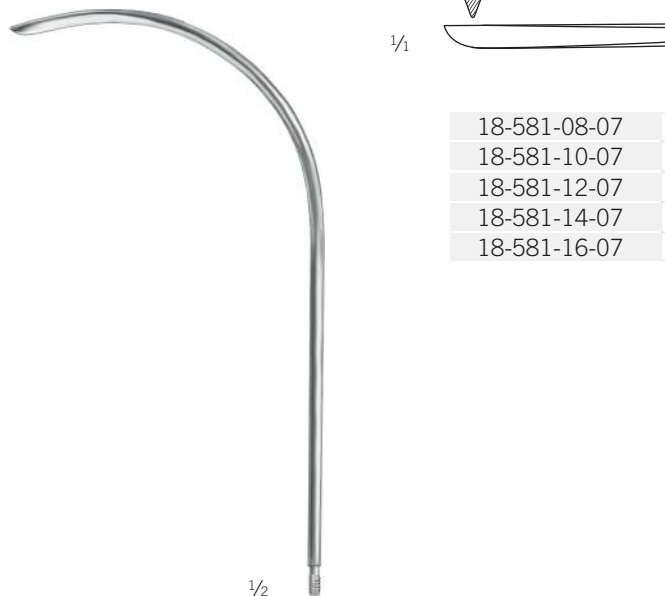
|              |              |
|--------------|--------------|
| 18-580-08-07 | <b>8 CH</b>  |
| 18-580-10-07 | <b>10 CH</b> |
| 18-580-12-07 | <b>12 CH</b> |
| 18-580-14-07 | <b>14 CH</b> |
| 18-580-16-07 | <b>16 CH</b> |

1/2

Redon  
18-580-08-07 -  
18-580-16-07

19,5 cm / 7 5/8"

mit Schraubgewinde  
threaded end  
roscada  
filetée  
con filetto



|              |              |
|--------------|--------------|
| 18-581-08-07 | <b>8 CH</b>  |
| 18-581-10-07 | <b>10 CH</b> |
| 18-581-12-07 | <b>12 CH</b> |
| 18-581-14-07 | <b>14 CH</b> |
| 18-581-16-07 | <b>16 CH</b> |

1/2

Redon  
18-581-08-07 -  
18-581-16-07

14 cm / 5 1/8"

mit Schraubgewinde  
threaded end  
roscada  
filetée  
con filetto

## Führungsnadeln

Guide Needles

Agujas de guía

Aiguilles d'introduction

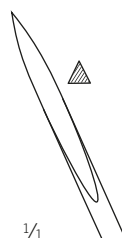
Aghi conduttori



|              |              |
|--------------|--------------|
| 18-583-08-07 | <b>8 CH</b>  |
| 18-583-10-07 | <b>10 CH</b> |
| 18-583-12-07 | <b>12 CH</b> |
| 18-583-14-07 | <b>14 CH</b> |
| 18-583-16-07 | <b>16 CH</b> |

1/2

Redon  
18-583-08-07 -  
18-583-16-07  
19,5 cm / 7 5/8"  
mit Schraubgewinde  
threaded end  
roscada  
filetée  
con filetto



|              |              |
|--------------|--------------|
| 18-584-08-07 | <b>8 CH</b>  |
| 18-584-10-07 | <b>10 CH</b> |
| 18-584-12-07 | <b>12 CH</b> |
| 18-584-14-07 | <b>14 CH</b> |
| 18-584-16-07 | <b>16 CH</b> |

1/2

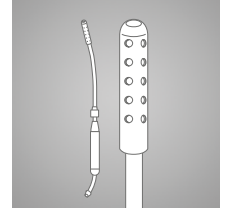
Redon  
18-584-08-07 -  
18-584-16-07  
19,5 cm / 7 5/8"  
mit Schraubgewinde  
threaded end  
roscada  
filetée  
con filetto

## Injektionskanülen

Hypodermic Needles  
Agujas hipodérmicas  
Aiguilles hypodérmiques  
Cannule per iniezione

## Sauger, Kanülen

Suction Tubes, Cannulas  
Tubos de Aspiración, Cánulas  
Tubes d'aspiration, Canules  
Tubi d'aspirazione, Cannule



1/2

18-606-00-01

Pudendus-Anästhesiekanüle  
Pudendus Anaesthesia Needle  
Cánula para anestesia transvaginal  
Canule pour anesthésie transvaginale  
Cannula per anestesia trasvaginale

komplett mit Nadel  
complete with needle  
completo con aguja  
complet avec aiguille  
completa con ago

18-606-01-01

Nadel  
Cannula  
Cánula  
Canule  
Cannula

**Ø 1 mm**

18-606-00-01 -  
18-606-01-01

17,5 cm / 7"

Luer-Lock Ansatz  
Luer Lock connection  
conexión Luer-Lock  
raccord Luer-Lock  
raccordo Luer-Lock



1/2

18-610-12-07 -  
18-610-15-07

Venenkanülen  
Vein Cannulas  
Cánulas para venas  
Canules veineuses  
Cannule per vene

|              |                    |
|--------------|--------------------|
| 18-610-12-07 | <b>1,2 x 80 mm</b> |
| 18-610-15-07 | <b>1,5 x 80 mm</b> |



1/2

18-611-20-07 -  
18-696-06-01


Heparinnadel, Luer-Lock-Ansatz  
Heparin Flushing Needle, Luer Lock connection  
Aguja para heparin, conexión Luer-Lock  
Aiguille pour héparine, raccord Luer-Lock  
Ago per eparina, raccordo Luer-Lock

|              |                    |
|--------------|--------------------|
| 18-611-20-07 | <b>2,0 x 45 mm</b> |
| 18-611-30-07 | <b>3,0 x 45 mm</b> |
| 18-611-37-07 | <b>3,7 x 55 mm</b> |
| 18-611-50-07 | <b>5,0 x 60 mm</b> |
| 18-696-06-01 | <b>2,9 x 65 mm</b> |

## Spezialkanülen

Special Needles  
Agujas especiales  
Aiguilles spéciales  
Aghi speciali

|              | Arbeitslänge<br>working length<br>largo útil<br>longueur utile<br>lunghezza utile |          |
|--------------|---|----------|
| 18-630-10-07 | 76 mm   | Ø 1,2 mm |
| 18-630-12-07 | 89 mm   | Ø 1,2 mm |
| 18-630-14-07 | 76 mm   | Ø 1,0 mm |
| 18-630-16-07 | 89 mm   | Ø 1,0 mm |
| 18-630-18-07 | 76 mm   | Ø 0,7 mm |
| 18-630-19-07 | 50 mm   | Ø 0,7 mm |
| 18-630-20-07 | 89 mm   | Ø 0,7 mm |

1/2 

Luer-Lock Ansatz  
Luer-Lock connection  
Conexión Luer-Lock  
Raccord Luer-Lock  
Raccordo Luer-Lock

|              | Arbeitslänge<br>working length<br>largo útil<br>longueur utile<br>lunghezza utile |  |
|--------------|---|---|
| 18-632-12-07 | 76 mm   | Ø 1,2 mm  |
| 18-632-14-07 | 76 mm   | Ø 1,4 mm  |
| 18-632-16-07 | 76 mm   | Ø 1,6 mm  |

1/2 



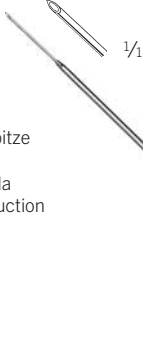

mit Spezialspitze, Luer-Lock Ansatz  
with special tip, Luer-Lock connection  
con punta especial, conexión Luer-Lock  
avec pointe spéciale, raccord Luer-Lock  
con punta speciale, raccordo Luer-Lock

Tuohy  
18-630-10-07 -  
18-630-20-07

Lumbalpunktionskanüle  
Lumbar Puncture Needle  
Aguja para punción lumbar  
Aiguille pour ponction lombaire  
Cannula per puntura lumbale

Tuohy  
18-632-12-07 -  
18-632-16-07

Lumbalpunktionskanüle  
Lumbar Puncture Needle  
Aguja para punción lumbar  
Aiguille pour ponction lombaire  
Cannula per puntura lumbale

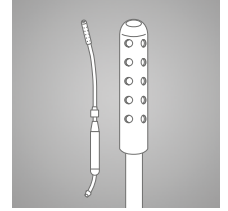
|   |   |   |  |
|---|---|---|--|
| 1/2                    | 1/1                    | 1/2    | 1/2    |
| abgesetzte Spitze<br>tapered tip<br>punta reducida<br>pointe de reduction<br>punta ridotta<br>Ø 0,65 mm   | abgesetzte Spitze<br>tapered tip<br>punta reducida<br>pointe de reduction<br>punta ridotta<br>Ø 0,80 mm   | abgesetzte Spitze<br>tapered tip<br>punta reducida<br>pointe de reduction<br>punta ridotta<br>Ø 0,65 mm   |  |
| 18-640-10-07  | 18-640-15-07  | 18-640-20-07  | 18-641-20-07<br>18-642-20-07   |
| Luer-Lock Ansatz<br>Luer Lock connection<br>conexión Luer-Lock<br>raccord Luer-Lock<br>raccordo Luer-Lock | Luer-Lock Ansatz<br>Luer Lock connection<br>conexión Luer-Lock<br>raccord Luer-Lock<br>raccordo Luer-Lock | Tonsillenkanüle, Luer-Lock-Ansatz<br>Tonsill cannula, Luer Lock connection<br>Cánula para amígdalas, conexión Luer-Lock<br>Aiguille pour amygdales, raccord Luer-Lock<br>Cannula per tonsille, raccordo Luer-Lock | Tonsillenkanüle, gewinkelt<br>Tonsil cannula, angled<br>Cánula para amígdalas, acodada<br>Aiguille pour amygdales, angulée<br>Cannula per tonsille, angolata |

## Saugkanülen

Suction Cannulas  
Cánulas de aspiración  
Canules d'aspiration  
Cannule di aspirazione

## Sauger, Kanülen

Suction Tubes, Cannulas  
Tubos de Aspiración, Cánulas  
Tubes d'aspiration, Canules  
Tubi d'aspirazione, Cannule



1/2

|              |          |
|--------------|----------|
| 18-645-15-07 | Ø 1,5 mm |
| 18-645-20-07 | Ø 2,0 mm |
| 18-645-25-07 | Ø 2,5 mm |
| 18-645-30-07 | Ø 3,0 mm |

Plester  
18-645-15-07 -  
18-645-30-07  
19,5 cm / 7 5/8"  
Saugkanüle  
Suction cannula  
Cánula de aspiración  
Canule d'aspiration  
Cannula di aspirazione



1/2

Ø 2,0 mm  
18-647-20-07  
16 cm / 6 2/8"  
Saugkanüle, biegsam  
Suction cannula, malleable  
Cánula de aspiración, maleable  
Canule d'aspiration, malléable  
Cannula di aspirazione, malleabile

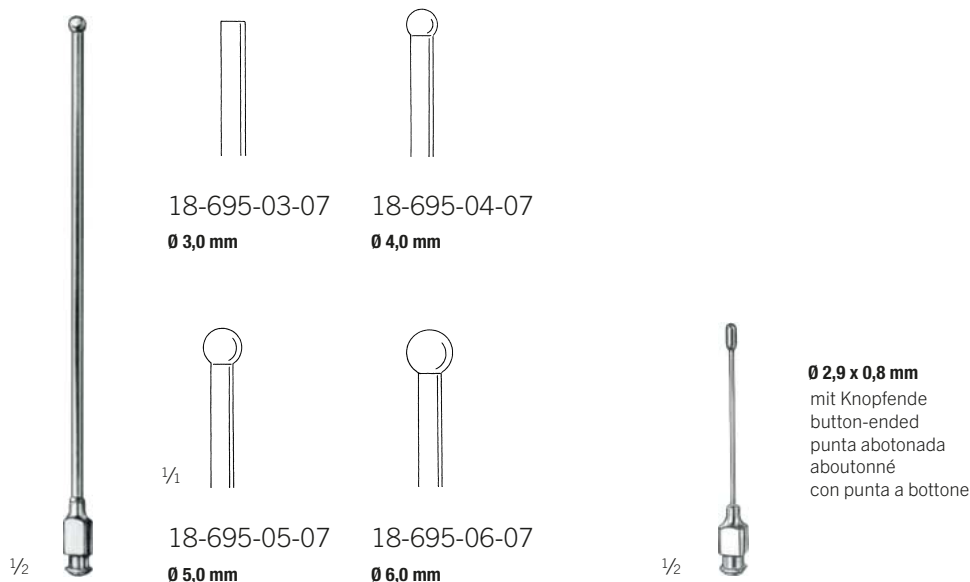
## Gefäß-Spülkanülen, Leberpunktionskanülen

Vessel Irrigation Cannulas, Liver Puncture Needles

Cánulas para irrigación vascular, Agujas para punción del hígado

Canules pour irrigation vasculaire, Aiguilles pour ponction du foie

Cannule per irrigazione vascolare, Cannule per la puntura del fetago



18-695-03-07

Ø 3,0 mm

18-695-04-07

Ø 4,0 mm

1/4

18-695-05-07

Ø 5,0 mm

18-695-06-07

Ø 6,0 mm

1/2

Ø 2,9 x 0,8 mm

mit Knopfende  
button-ended  
punta abotonada  
aboutonné  
con punta a bottone

Schmid

18-695-03-07 -

18-695-06-07

15 cm / 5 7/8"

biegsam, Luer-Lock Ansatz  
malleable, Luer-Lock connection  
maleable, conexión Luer-Lock  
malléable, raccord Luer-Lock  
malleabili, raccordo Luer-Lock

Mock

18-696-06-01

6,5 cm / 2 4/8"

Heparinnadel, Luer-Lock Ansatz  
Heparin Flushing Needle, Luer Lock connection  
Aguja para heparin, conexión Luer-Lock  
Aiguille pour héparine, raccord Luer-Lock  
Ago per eparina, raccordo Luer-Lock



1/2

|              | Arbeitslänge<br>working length<br>largo útil<br>longueur utile<br>lunghezza utile |          |
|--------------|---|----------|
| 18-700-10-07 | 35 mm   | Ø 1,0 mm |
| 18-700-15-07 | 70 mm   | Ø 1,0 mm |
| 18-700-20-07 | 70 mm   | Ø 1,2 mm |
| 18-700-25-07 | 100 mm  | Ø 1,2 mm |
| 18-700-30-07 | 70 mm   | Ø 1,4 mm |
| 18-700-35-07 | 100 mm  | Ø 1,4 mm |
| 18-700-40-07 | 70 mm   | Ø 1,6 mm |
| 18-700-50-07 | 100 mm  | Ø 1,8 mm |

Menghini

18-700-10-07 -

18-700-50-07

für Leberblindpunktion, mit Stoppsonde  
for liver blind puncture, with stopping probe  
para punción ciega del hígado, con aguja limitadora  
pour ponction aveugle du foie, avec clou d'arrêt  
per puntatura con ago limitatore



|              | Arbeitslänge<br>working length<br>largo útil<br>longueur utile<br>lunghezza utile |          |
|--------------|---|----------|
| 18-710-18-02 | 168 mm  | Ø 1,8 mm |

Menghini

18-710-18-02

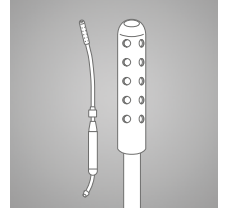
für gezielte Leberpunktion  
for controlled liver blind puncture  
para punción controlada del hígado  
pour ponction contrôlée du foie  
per puntatura controllata del fetago

## Verbindungsstücke, Hähne

Connecting Pieces  
Piezas de conexión  
Raccords  
Raccordi

## Sauger, Kanülen

Suction Tubes, Cannulas  
Tubos de Aspiración, Cánulas  
Tubes d'aspiration, Canules  
Tubi d'aspirazione, Cannule



1/2

18-800-00-02

Zwischenstück  
Connector  
Conector  
Raccord  
Raccordo

LL = weiblich, RC = männlich  
LL = female, RC = male  
LL = hembra, RC = macho  
LL = femelle, RC = mâle  
LL = femminile, RC = maschile



1/2

18-802-00-02

Zwischenstück  
Connector  
Conector  
Raccord  
Raccordo

RC = weiblich, Luer = männlich  
RC = female, Luer = male  
RC = hembra, Luer = macho  
RC = femelle, Luer = mâle  
RC = femminile, Luer = maschile



1/2

18-804-00-02

Schlauchverbinder  
Connector  
Conector  
Raccord  
Raccordo

LL = männlich  
LL = male  
LL = macho  
LL = mâle  
LL = maschile



1/2

18-806-00-02

Schlauchverbinder  
Connector  
Conector  
Raccord  
Raccordo

LL = weiblich  
LL = female  
LL = hembra  
LL = femelle  
LL = femminile



1/2

18-825-01-02    **Ø 2,5 / 4,0 mm**

18-825-02-02    **Ø 2,5 / 6,5 mm**

18-825-03-02    **Ø 3,0 / 9,0 mm**

18-825-01-02 -  
18-825-03-02

Katheteransatz, konisch  
Catheter Fitting, conical  
Adaptador para catéteres, cónico  
Adaptateur pour cathéters, conique  
Adattatore per cateteri, conico

Luer-Lock Ansatz = weiblich  
Luer-Lock connection = female  
conexión Luer-Lock = hembra  
raccord Luer-Lock = femelle  
raccordo Luer-Lock = femminile



1/2

18-840-00-02

Durchflußhahn  
Stopcock  
Llave  
Robinet  
Rubinetto

LL = weiblich/männlich  
LL = female/male  
LL = hembra/macho  
LL = femelle/mâle  
LL = femminile/maschile



1/2

18-845-00-02

Dreiwegehahn  
3-Way Stopcock  
Llave de 3 vías  
Robinet à trois voies  
Rubinetto a tre vie

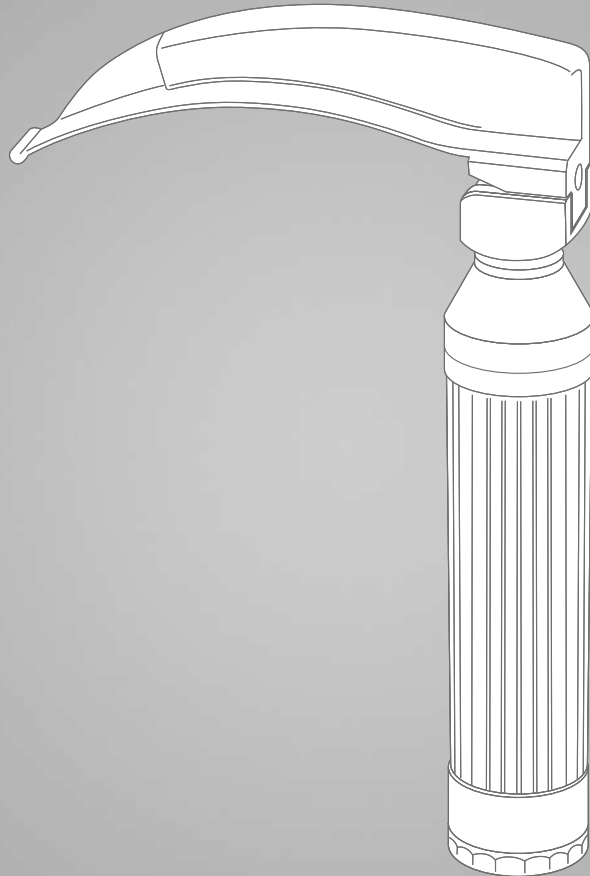
1 x LL = männlich, 2 x LL = weiblich  
1 x LL male, 2 x LL = female  
1 x LL macho, 2 x LL = hembra  
1 x LL mâle, 2 x LL = femelle  
1 x LL maschile, 2 x LL = femminile





Narkose  
Anaesthesia  
Anestesia  
Anesthésie  
Anestesia

# 19



## Kathetereinführinstrumente

Catheter insertion instruments

Instrumentos para inserción de catéteres

Instruments d'insertion de cathéter

Strumenti per inserimento catetere



19-301-15-07

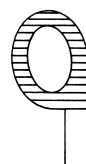
15,5 cm / 6 1/8"

für Kleinkinder  
for babies  
para neonatales  
pour nourrissons  
per neonati



17,5 cm / 6 7/8"

für Kinder  
for children  
para niños  
pour enfants  
per bambini



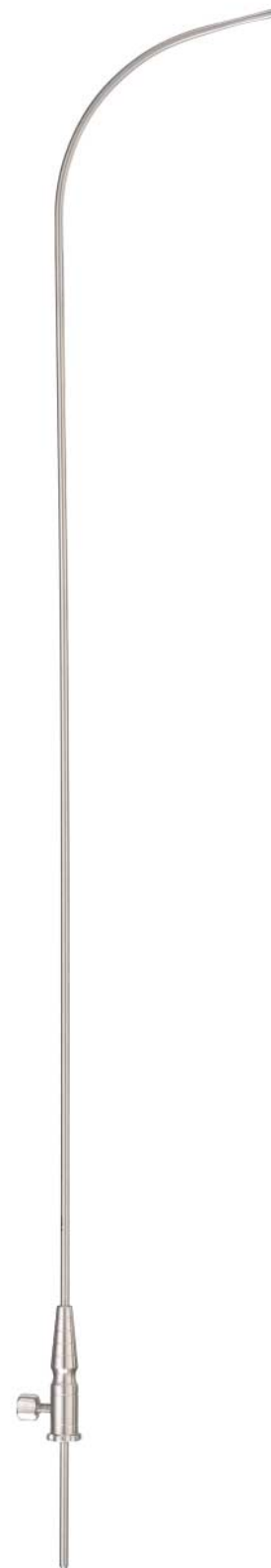
20 cm / 7 7/8"

für Erwachsene  
for adults  
para adultos  
pour adultes  
per adulti



Magill

19-301-15-07 -  
19-303-25-07



Dittel

19-305-46-07  
46 cm / 8 1/8"

## Laryngoskope und Zubehör

Laryngoscopes and Accessories

Laringoscopios y accesorios

Laryngoscopes et accessoires

Laringoscopi ed accessori

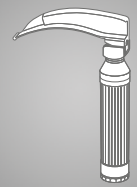
## Narkose

Anaesthesia

Anestesia

Anesthésie

Anestesia



Miller/Miller-Baby  
19-350-00-07 -  
19-353-04-07

### Miller

19-350-00-07

Set mit Batteriehandgriff (ohne Batterien) und drei Laryngoskopspateln Fig. 1 bis 3, komplett, in Etui

Set with battery handle (without batteries) and three laryngoscope blades fig. 1 to 3, complete, in case

Juego con mango de pilas (sin pilas) y tres hojas de laringoscopia fig. 1 a 3, completo, en estuche

Set avec manche à pile (sans pile) et trois spatules à laryngoscopie fig. 1 à 3, complet, en trousse

Set con manico a pila (senza pila) e tre spatole per laringoscopia fig. 1 fino a 3, completo, in scatola

### Miller

19-351-00-07

Set mit Batteriehandgriff (ohne Batterien) und vier Laryngoskopspateln Fig. 1 bis 4, komplett, in Etui

Set with battery handle (without batteries) and four laryngoscope blades fig. 1 to 4, complete, in case

Juego con mango de pilas (sin pilas) y cuatro hojas de laringoscopia fig. 1 a 4, completo, en estuche

Set avec manche à pile (sans pile) et quatre spatules à laryngoscopie fig. 1 à 4, complet, en trousse

Set con manico a pila (senza pila) e quattro spatole per laringoscopia fig. 1 fino a 4, completo, in scatola

### Miller-Baby

19-352-00-07

Set mit Batteriehandgriff (ohne Batterien) und zwei Laryngoskopspateln Fig. 0 und 1, komplett, in Etui

Set with battery handle (without batteries) and two laryngoscope blades fig. 0 and 1, complete, in case

Juego con mango de pilas (sin pilas) y dos hojas de laringoscopia fig. 0 y 1, completo, en estuche

Set avec manche à pile (sans pile) et deux spatules à laryngoscopie fig. 0 et 1, complet, en trousse

Set con manico a pila (senza pila) e due spatole per laringoscopia fig. 0 e 1, completo, in scatola



1/2

19-353-00-07

#### Fig. 0

für Säuglinge  
for babies  
para neonatales  
pour nourrissons  
per neonati

Nutzlänge  
working length  
largo útil  
longueur utile  
lunghezza operante  
**55 mm**

19-353-01-07

#### Fig. 1

für Kinder  
for children  
para niños  
pour enfants  
per bambini

Nutzlänge  
working length  
largo útil  
longueur utile  
lunghezza operante  
**80 mm**

19-353-02-07

#### Fig. 2

für Jugendliche  
for adolescents  
para adolescentes  
pour adolescents  
per adolescenti

Nutzlänge  
working length  
largo útil  
longueur utile  
lunghezza operante  
**130 mm**

19-353-03-07

#### Fig. 3

für Frauen  
for women  
para mujeres  
pour femmes  
per donne

Nutzlänge  
working length  
largo útil  
longueur utile  
lunghezza operante  
**170 mm**

19-353-04-07

#### Fig. 4

für Männer  
for men  
para hombres  
pour hommes  
per uomini

Nutzlänge  
working length  
largo útil  
longueur utile  
lunghezza operante  
**180 mm**

# Laryngoskope und Zubehör

Laryngoscopes and Accessories

Laringoscopios y accesorios

Laryngoscopes et accessoires

Laringoscopi ed accessori



Guedel-Negus  
19-360-00-07 -  
19-363-04-07

## 19-360-00-07

Set mit Batteriehandgriff (ohne Batterien) und drei Laryngoskopspateln Fig. 2 bis 4, komplett, in Etui

Set with battery handle (without batteries) and three laryngoscope blades fig. 2 to 4, complete, in case

Juego con mango de pilas (sin pilas) y tres hojas de laringoscopio fig. 2 a 4, completo, en estuche

Set avec manche à pile (sans pile) et trois spatules à laryngoscopie fig. 2 à 4, complet, en trousse

Set con manico a pila (senza pila) e tre spatole per laringoscopia fig. 2 fino a 4, completo, in scatola

## 19-361-00-07

Set mit Batteriehandgriff (ohne Batterien) und vier Laryngoskopspateln Fig. 1 bis 4, komplett, in Etui

Set with battery handle (without batteries) and four laryngoscope blades fig. 1 to 4, complete, in case

Juego con mango de pilas (sin pilas) y cuatro hojas de laringoscopio fig. 1 a 4, completo, en estuche

Set avec manche à pile (sans pile) et quatre spatules à laryngoscopie fig. 1 à 4, complet, en trousse

Set con manico a pila (senza pila) e quattro spatole per laringoscopia fig. 1 fino a 4, completo, in scatola



## 19-363-01-07

### Fig. 1

für Kinder  
for children  
para niños  
pour enfants  
per bambini

Nutzlänge  
working length  
largo útil  
longueur utile  
lunghezza operante  
**70 mm**



## 19-363-02-07

### Fig. 2

für Jugendliche  
for adolescents  
para adolescentes  
pour adolescents  
per adolescenti

Nutzlänge  
working length  
largo útil  
longueur utile  
lunghezza operante  
**90 mm**



## 19-363-03-07

### Fig. 3

für Frauen  
for women  
para mujeres  
pour femmes  
per donne

Nutzlänge  
working length  
largo útil  
longueur utile  
lunghezza operante  
**110 mm**



## 19-363-04-07

### Fig. 4

für Männer  
for men  
para hombres  
pour hommes  
per uomini

Nutzlänge  
working length  
largo útil  
longueur utile  
lunghezza operante  
**135 mm**

## Laryngoskope und Zubehör

Laryngoscopes and Accessories

Laringoscopios y accesorios

Laryngoscopes et accessoires

Laringoscopi ed accessori

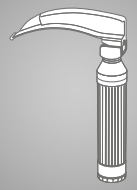
## Narkose

Anaesthesia

Anestesia

Anesthésie

Anestesia



### 19-380-00-07

Set mit Batteriehandgriff (ohne Batterien) und drei Laryngoskopspateln Fig. 1 bis 3, komplett, in Etui

Set with battery handle (without batteries) and three laryngoscope blades fig. 1 to 3, complete, in case

Juego con mango de pilas (sin pilas) y tres hojas de laringoscopio fig. 1 a 3, completo, en estuche

Set avec manche à pile (sans pile) et trois spatules à laryngoscopie fig. 1 à 3, complet, en trousse

Set con manico a pila (senza pila) e tre spatole per laringoscopia fig. 1 fino a 3, completo, in scatola

### 19-384-00-07

Set mit Batteriehandgriff (ohne Batterien) und vier Laryngoskopspateln Fig. 1 bis 4, komplett, in Etui

Set with battery handle (without batteries) and four laryngoscope blades fig. 1 to 4, complete, in case

Juego con mango de pilas (sin pilas) y cuatro hojas de laringoscopio fig. 1 a 4, completo, en estuche

Set avec manche à pile (sans pile) et quatre spatules à laryngoscopie fig. 1 à 4, complet, en trousse

Set con manico a pila (senza pila) e quattro spatole per laringoscopia fig. 1 fino a 4, completo, in scatola

McIntosh  
19-380-00-07 -  
19-384-00-07



### 19-383-00-07

#### Fig. 0

für Säuglinge  
for babies  
para neonatales  
pour nourrissons  
per neonati

Nutzlänge  
working length  
largo útil  
longueur utile  
lunghezza operante  
**55 mm**



### 19-383-01-07

#### Fig. 1

für Kinder  
for children  
para niños  
pour enfants  
per bambini

Nutzlänge  
working length  
largo útil  
longueur utile  
lunghezza operante  
**75 mm**



### 19-383-02-07

#### Fig. 2

für Jugendliche  
for adolescents  
para adolescentes  
pour adolescents  
per adolescenti

Nutzlänge  
working length  
largo útil  
longueur utile  
lunghezza operante  
**90 mm**



### 19-383-03-07

#### Fig. 3

für Frauen  
for women  
para mujeres  
pour femmes  
per donne

Nutzlänge  
working length  
largo útil  
longueur utile  
lunghezza operante  
**110 mm**



### 19-383-04-07

#### Fig. 4

für Männer  
for men  
para hombres  
pour hommes  
per uomini

Nutzlänge  
working length  
largo útil  
longueur utile  
lunghezza operante  
**135 mm**

1/2

# Laryngoskope und Zubehör

Laryngoscopes and Accessories

Laringoscopios y accesorios

Laryngoscopes et accessoires

Laringoscopi ed accessori



Foregger  
19-387-01-07 -  
19-391-00-07

## 19-390-00-07

Set mit Batteriehandgriff (ohne Batterien) und drei Laryngoskopspateln Fig. 2 bis 4, komplett, in Etui

Set with battery handle (without batteries) and three laryngoscope blades fig. 2 to 4, complete, in case

Juego con mango de pilas (sin pilas) y tres hojas de laringoscopio fig. 2 a 4, completo, en estuche

Set avec manche à pile (sans pile) et trois spatules à laryngoscopie fig. 2 à 4, complet, en trousse

Set con manico a pila (senza pila) e tre spatole per laringoscopia fig. 2 fino a 4, completo, in scatola

## 19-391-00-07

Set mit Batteriehandgriff (ohne Batterien) und vier Laryngoskopspateln Fig. 1 bis 4, komplett, in Etui

Set with battery handle (without batteries) and four laryngoscope blades fig. 1 to 4, complete, in case

Juego con mango de pilas (sin pilas) y cuatro hojas de laringoscopio fig. 1 a 4, completo, en estuche

Set avec manche à pile (sans pile) et quatre spatules à laryngoscopie fig. 1 à 4, complet, en trousse

Set con manico a pila (senza pila) e quattro spatole per laringoscopia fig. 1 fino a 4, completo, in scatola



## 19-387-01-07

**Fig. 1**

für Kinder  
for children  
para niños  
pour enfants  
per bambini

Nutzlänge  
working length  
largo útil  
longueur utile  
lunghezza operante  
**70 mm**



## 19-387-02-07

**Fig. 2**

für Jugendliche  
for adolescents  
para adolescentes  
pour adolescents  
per adolescenti

Nutzlänge  
working length  
largo útil  
longueur utile  
lunghezza operante  
**90 mm**



## 19-387-03-07

**Fig. 3**

für Frauen  
for women  
para mujeres  
pour femmes  
per donne

Nutzlänge  
working length  
largo útil  
longueur utile  
lunghezza operante  
**110 mm**



## 19-387-04-07

**Fig. 4**

für Männer  
for men  
para hombres  
pour hommes  
per uomini

Nutzlänge  
working length  
largo útil  
longueur utile  
lunghezza operante  
**135 mm**

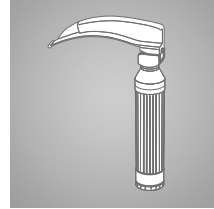
1/2

## Laryngoskope und Zubehör

Laryngoscopes and Accessories  
Laringoscopios y accesorios  
Laryngoscopes et accessoires  
Laringoscopi ed accessori

## Narkose

Anaesthesia  
Anestesia  
Anesthésie  
Anestesia



1/2

### 19-392-00-02

Handgriff für Warmlichtspatel und zwei Batterien  
Typ C (ohne Batterien)

Handle for warm light blade and two type C batteries  
(batteries not included)

Mango para espátula de luz cálida y dos pilas tipo C  
(sin pilas)

Manche pour spatule à lumière chaude et deux  
piles de type C (sans piles)

Manico per spatola a luce calda e due batterie tipo C  
(senza batterie)



1/1

### 19-395-00-04

Ersatzlampe groß, für Spatel  
Spare bulb large, for blades

Bombilla de recambio grande, para hojas  
Ampoule de rechange grande, pour spatule  
Lampadina di ricambio grande, per spatola



19-353-04-07,  
19-363-02-07,  
19-363-03-07,  
19-363-04-07,  
19-383-01-07,  
19-383-02-07,  
19-383-03-07,  
19-383-04-07,  
19-387-02-07,  
19-387-03-07,  
19-387-04-07



1/1

### 19-395-01-04

Ersatzlampe klein, für Spatel  
Spare bulb small, for blades

Bombilla de recambio pequeña, para hojas  
Ampoule de rechange petite, pour spatule  
Lampadina di ricambio piccola, per spatola



19-353-00-07,  
19-353-01-07,  
19-353-02-07,  
19-353-03-07,  
19-363-01-07,  
19-383-00-07,  
19-387-01-07



**Etui für Laryngoskope (Warm- und Kaltlicht)**  
**Case for Laryngoscopes (warm light and cold light)**  
**Estuche para laringoscopios (luz cálida y fría)**  
**Trousse pour laryngoscopes (lumière chaude et froide)**  
**Scatola per laringoscopia (luce calda e fredda)**

#### 19-398-01-04

für drei gerade Laryngoskopspatel  
for three straight laryngoscope blades  
para tres hojas de laringoscopia rectas  
pour trois spatules à laryngoscopie droites  
per tre spatole per laringoscopia retta

#### 19-398-02-04

für vier gerade Laryngoskopspatel  
for four straight laryngoscope blades  
para cuatro hojas de laringoscopia rectas  
pour quatre spatules à laryngoscopie droites  
per quattro spatole per laringoscopia retta

#### 19-398-03-04

für drei gebogene Laryngoskopspatel  
for three curved laryngoscope blades  
para tres hojas de laringoscopia curvas  
pour trois spatules à laryngoscopie courbées  
per tre spatole per laringoscopia curva

#### 19-398-04-04

für vier gebogene Laryngoskopspatel  
for four curved laryngoscope blades  
para cuatro hojas de laringoscopia curvas  
pour quatre spatules à laryngoscopie courbées  
per quattro spatole per laringoscopia curva

## Kaltlicht-Laryngoskope und Zubehör

Fiber Optic Laryngoscopes and Accessories

Laringoscopios de luz fría y accesorios

Laryngoscopes de lumière froide et accessoires

Laringoscopi di luce fredda ed accessori



McIntosh  
19-500-00-07 -  
19-520-04-07

### 19-500-00-07

Set mit Batteriehandgriff 19-600-00-02 (ohne Batterien) und drei Laryngoskopspateln Fig. 1 bis 3, komplett, in Etui

Set with battery handle 19-600-00-02 (without batteries) and three laryngoscope blades fig. 1 to 3, complete, in case

Juego con mango de pilas 19-600-00-02 (sin pilas) y tres hojas de laringoscopio fig. 1 a 3, completo, en estuche

Set avec manche à pile 19-600-00-02 (sans pile) et trois spatules à laryngoscopie fig. 1 à 3, complet, en trousse

Set con manico a pila 19-600-00-02 (senza pila) e tre spatole per laringoscopia fig. 1 fino a 3, completo, in scatola

### 19-510-00-07

Set mit Batteriehandgriff 19-600-00-02 (ohne Batterien) und vier Laryngoskopspateln Fig. 1 bis 4, komplett, in Etui

Set with battery handle 19-600-00-02 (without batteries) and four laryngoscope blades fig. 1 to 4, complete, in case

Juego con mango de pilas 19-600-00-02 (sin pilas) y cuatro hojas de laringoscopio fig. 1 a 4, completo, en estuche

Set avec manche à pile 19-600-00-02 (sans pile) et quatre spatules à laryngoscopie fig. 1 à 4, complet, en trousse

Set con manico a pila 19-600-00-02 (senza pila) e quattro spatole per laringoscopia fig. 1 fino a 4, completo, in scatola



## Kaltlicht-Laryngoskope und Zubehör

Fiber Optic Laryngoscopes and Accessories

Laringoscopios de luz fría y accesorios

Laryngoscopes de lumière froide et accessoires

Laringoscopi di luce fredda ed accessori

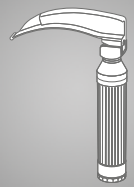
## Narkose

Anaesthesia

Anestesia

Anesthésie

Anestesia



19-520-00-07

### Fig. 0

für Säuglinge  
for babies  
para neonatales  
pour nourrissons  
per neonati

Nutzlänge  
working length  
largo útil  
longueur utile  
lunghezza operante  
**55 mm**



19-520-01-07

### Fig. 1

für Kinder  
for children  
para niños  
pour enfants  
per bambini

Nutzlänge  
working length  
largo útil  
longueur utile  
lunghezza operante  
**70 mm**



19-520-02-07

### Fig. 2

für Jugendliche  
for adolescents  
para adolescentes  
pour adolescents  
per adolescenti

Nutzlänge  
working length  
largo útil  
longueur utile  
lunghezza operante  
**85 mm**



19-520-03-07

### Fig. 3

für Frauen  
for women  
para mujeres  
pour femmes  
per donne

Nutzlänge  
working length  
largo útil  
longueur utile  
lunghezza operante  
**105 mm**



19-520-04-07

### Fig. 4

für Männer  
for men  
para hombres  
pour hommes  
per uomini

Nutzlänge  
working length  
largo útil  
longueur utile  
lunghezza operante  
**130 mm**



## Kaltlicht-Laryngoskope und Zubehör

Fiber Optic Laryngoscopes and Accessories

Laringoscopios de luz fría y accesorios

Laryngoscopes de lumière froide et accessoires

Laringoscopi di luce fredda ed accessori



### Foregger

19-540-00-07 -

19-560-04-07

#### 19-540-00-07

Set mit Batteriehandgriff 19-600-00-02 (ohne Batterien) und drei Laryngoskopspateln Fig. 2 bis 4, komplett, in Etui

Set with battery handle 19-600-00-02 (without batteries) and three laryngoscope blades fig. 2 to 4, complete, in case

Juego con mango de pilas 19-600-00-02 (sin pilas) y tres hojas de laringoscopio fig. 2 a 4, completo, en estuche

Set avec manche à pile 19-600-00-02 (sans pile) et trois spatules à laryngoscopie fig. 2 à 4, complet, en trousse

Set con manico a pila 19-600-00-02 (senza pila) e tre spatole per laringoscopia fig. 2 fino a 4, completo, in scatola

#### 19-550-00-07

Set mit Batteriehandgriff 19-600-00-02 (ohne Batterien) und vier Laryngoskopspateln Fig. 1 bis 4, komplett, in Etui

Set with battery handle 19-600-00-02 (without batteries) and four laryngoscope blades fig. 1 to 4, complete, in case

Juego con mango de pilas 19-600-00-02 (sin pilas) y cuatro hojas de laringoscopio fig. 1 a 4, completo, en estuche

Set avec manche à pile 19-600-00-02 (sans pile) et quatre spatules à laryngoscopie fig. 1 à 4, complet, en trousse

Set con manico a pila 19-600-00-02 (senza pila) e quattro spatole per laringoscopia fig. 1 fino a 4, completo, in scatola

## Kaltlicht-Laryngoskope und Zubehör

Fiber Optic Laryngoscopes and Accessories

Laringoscopios de luz fría y accesorios

Laryngoscopes de lumière froide et accessoires

Laringoscopi di luce fredda ed accessori

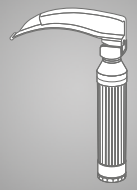
## Narkose

Anaesthesia

Anestesia

Anesthésie

Anestesia



19-560-00-07

### Fig. 0

für Säuglinge  
for babies  
para neonatales  
pour nourrissons  
per neonati

Nutzlänge  
working length  
largo útil  
longueur utile  
lunghezza operante  
**55 mm**



19-560-01-07

### Fig. 1

für Kinder  
for children  
para niños  
pour enfants  
per bambini

Nutzlänge  
working length  
largo útil  
longueur utile  
lunghezza operante  
**70 mm**



19-560-02-07

### Fig. 2

für Jugendliche  
for adolescents  
para adolescentes  
pour adolescents  
per adolescenti

Nutzlänge  
working length  
largo útil  
longueur utile  
lunghezza operante  
**90 mm**



19-560-03-07

### Fig. 3

für Frauen  
for women  
para mujeres  
pour femmes  
per donne

Nutzlänge  
working length  
largo útil  
longueur utile  
lunghezza operante  
**110 mm**



19-560-04-07

### Fig. 4

für Männer  
for men  
para hombres  
pour hommes  
per uomini

Nutzlänge  
working length  
largo útil  
longueur utile  
lunghezza operante  
**135 mm**



1/2

## Kaltlicht-Laryngoskope und Zubehör

Fiber Optic Laryngoscopes and Accessories

Laringoscopios de luz fría y accesorios

Laryngoscopes de lumière froide et accessoires

Laringoscopi di luce fredda ed accessori



Miller

19-565-00-07 -

19-585-04-07

### 19-565-00-07

Set mit Batteriehandgriff 19-600-00-02 (ohne Batterien) und drei Laryngoskopspateln Fig. 1 bis 3, komplett, in Etui

Set with battery handle 19-600-00-02 (without batteries) and three laryngoscope blades fig. 1 to 3, complete, in case

Juego con mango de pilas 19-600-00-02 (sin pilas) y tres hojas de laringoscopio fig. 1 a 3, completo, en estuche

Set avec manche à pile 19-600-00-02 (sans pile) et trois spatules à laryngoscopie fig. 1 à 3, complet, en trousse

Set con manico a pila 19-600-00-02 (senza pila) e tre spatole per laringoscopia fig. 1 fino a 3, completo, in scatola

### 19-575-00-07

Set mit Batteriehandgriff 19-600-00-02 (ohne Batterien) und vier Laryngoskopspateln Fig. 1 bis 4, komplett, in Etui

Set with battery handle 19-600-00-02 (without batteries) and four laryngoscope blades fig. 1 to 4, complete, in case

Juego con mango de pilas 19-600-00-02 (sin pilas) y cuatro hojas de laringoscopio fig. 1 a 4, completo, en estuche

Set avec manche à pile 19-600-00-02 (sans pile) et quatre spatules à laryngoscopie fig. 1 à 4, complet, en trousse

Set con manico a pila 19-600-00-02 (senza pila) e quattro spatole per laringoscopia fig. 1 fino a 4, completo, in scatola

## Kaltlicht-Laryngoskope und Zubehör

Fiber Optic Laryngoscopes and Accessories

Laringoscopios de luz fría y accesorios

Laryngoscopes de lumière froide et accessoires

Laringoscopi di luce fredda ed accessori

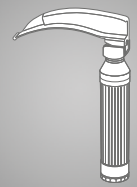
## Narkose

Anaesthesia

Anestesia

Anesthésie

Anestesia



# J



19-585-00-07

### Fig. 0

für Säuglinge  
for babies  
para neonatales  
pour nourrissons  
per neonati

Nutzlänge  
working length  
largo útil  
longueur utile  
lunghezza operante  
**55 mm**



19-585-01-07

### Fig. 1

für Kinder  
for children  
para niños  
pour enfants  
per bambini

Nutzlänge  
working length  
largo útil  
longueur utile  
lunghezza operante  
**80 mm**



19-585-02-07

### Fig. 2

für Jugendliche  
for adolescents  
para adolescentes  
pour adolescents  
per adolescenti

Nutzlänge  
working length  
largo útil  
longueur utile  
lunghezza operante  
**130 mm**



19-585-03-07

### Fig. 3

für Frauen  
for women  
para mujeres  
pour femmes  
per donne

Nutzlänge  
working length  
largo útil  
longueur utile  
lunghezza operante  
**170 mm**



19-585-04-07

### Fig. 4

für Männer  
for men  
para hombres  
pour hommes  
per uomini

Nutzlänge  
working length  
largo útil  
longueur utile  
lunghezza operante  
**189 mm**

1/2

## Kaltlicht-Laryngoskope und Zubehör

Fiber Optic Laryngoscopes and Accessories

Laringoscopios de luz fría y accesorios

Laryngoscopes de lumière froide et accessoires

Laringoscopi di luce fredda ed accessori



1/2

### 19-600-00-02

Handgriff für zwei Batterien Typ C (ohne Batterien)  
für Kaltlichtspatel, 2,5 V

Handle for two type C batteries (batteries not included)  
for cold light blade, 2.5 V

Mango para dos pilas tipo C (sin pilas) para espátula  
de luz fría, 2,5 V

Manche pour deux piles de type C (sans piles)  
pour spatule à lumière froide, 2,5 V

Manico per due batterie tipo C (senza batterie)  
per spatola a luce fredda, 2,5 V



1/2

### 19-615-00-02

Handgriff für zwei Batterien Typ AA (ohne Batterien)  
für Kaltlichtspatel, 2,5 V

Handle for two type AA batteries (batteries not included)  
for cold light blade, 2.5 V

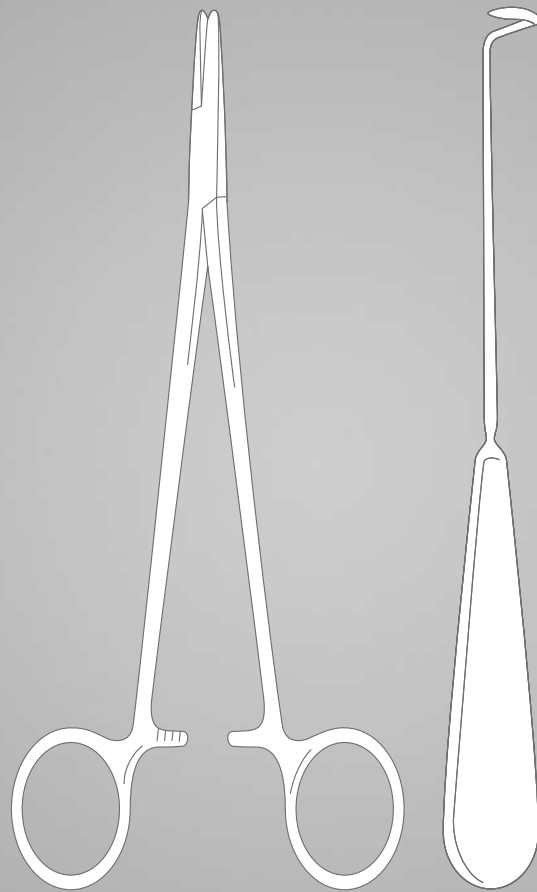
Mango para dos pilas tipo AA (sin pilas) para espátula  
de luz fría, 2,5 V

Manche pour deux piles de type AA (sans piles)  
pour spatule à lumière froide, 2,5 V

Manico per due batterie tipo AA (senza batterie)  
per spatola a luce fredda, 2,5 V

Naht  
Suture  
Sutura  
Suture  
Sutura

# 20



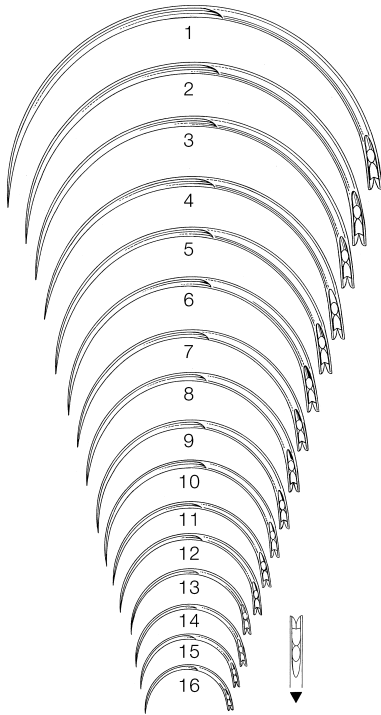
# Chirurgische Nadeln

Surgical Needles

Agujas quirúrgicas

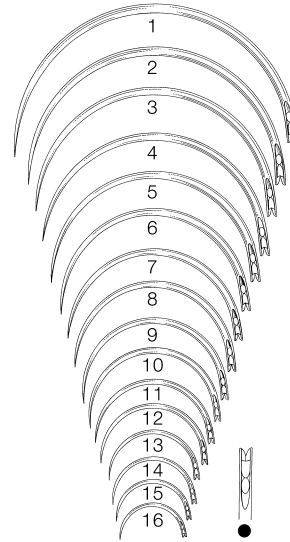
Aiguilles chirurgicales

Aghi chirurgici



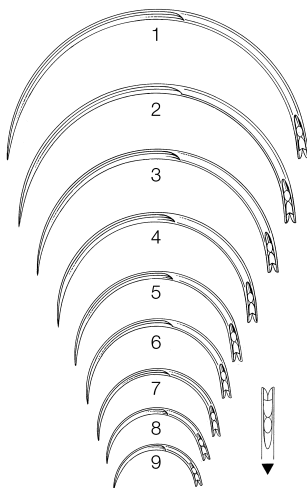
|              | Fig. |
|--------------|------|
| 20-123-01-04 | 1    |
| 20-123-02-04 | 2    |
| 20-123-03-04 | 3    |
| 20-123-04-04 | 4    |
| 20-123-05-04 | 5    |
| 20-123-06-04 | 6    |
| 20-123-07-04 | 7    |
| 20-123-08-04 | 8    |
| 20-123-09-04 | 9    |
| 20-123-10-04 | 10   |
| 20-123-11-04 | 11   |
| 20-123-12-04 | 12   |
| 20-123-13-04 | 13   |
| 20-123-14-04 | 14   |
| 20-123-15-04 | 15   |
| 20-123-16-04 | 16   |

gebogen 1/2 Kreis, VE = 12 Stück  
 curved, 1/2 circle, SU = 12/pack  
 curvas 1/2 círculo, UV = 12 piezas  
 courbes 1/2 cercle, UC = 12 untiés  
 curvi 1/2 circolo, UV = 12 pezzi



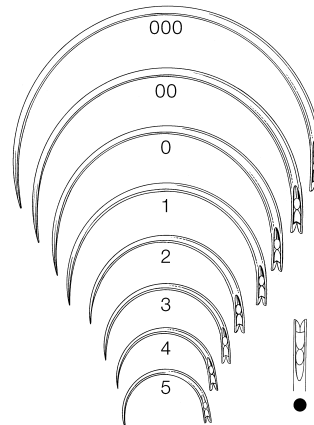
|              | Fig. |
|--------------|------|
| 20-127-01-04 | 1    |
| 20-127-02-04 | 2    |
| 20-127-03-04 | 3    |
| 20-127-04-04 | 4    |
| 20-127-05-04 | 5    |
| 20-127-06-04 | 6    |
| 20-127-07-04 | 7    |
| 20-127-08-04 | 8    |
| 20-127-09-04 | 9    |
| 20-127-10-04 | 10   |
| 20-127-11-04 | 11   |
| 20-127-12-04 | 12   |
| 20-127-13-04 | 13   |
| 20-127-14-04 | 14   |
| 20-127-15-04 | 15   |
| 20-127-16-04 | 16   |

gebogen 1/2 Kreis, VE = 12 Stück  
 curved, 1/2 circle, SU = 12/pack  
 curvas 1/2 círculo, UV = 12 piezas  
 courbes 1/2 cercle, UC = 12 untiés  
 curvi 1/2 circolo, UV = 12 pezzi



|              | Fig. |
|--------------|------|
| 20-133-01-04 | 1    |
| 20-133-02-04 | 2    |
| 20-133-03-04 | 3    |
| 20-133-04-04 | 4    |
| 20-133-05-04 | 5    |
| 20-133-06-04 | 6    |
| 20-133-07-04 | 7    |
| 20-133-08-04 | 8    |
| 20-133-09-04 | 9    |

gebogen 1/2 Kreis, VE = 12 Stück  
 curved, 1/2 circle, SU = 12/pack  
 curvas 1/2 círculo, UV = 12 piezas  
 courbes 1/2 cercle, UC = 12 untiés  
 curvi 1/2 circolo, UV = 12 pezzi



|              | Fig. |
|--------------|------|
| 20-154-10-04 | 0    |
| 20-154-20-04 | 00   |
| 20-154-30-04 | 000  |
| 20-155-01-04 | 1    |
| 20-155-02-04 | 2    |
| 20-155-03-04 | 3    |
| 20-155-04-04 | 4    |
| 20-155-05-04 | 5    |

gebogen 1/2 Kreis, VE = 12 Stück  
 curved, 1/2 circle, SU = 12/pack  
 curvas 1/2 círculo, UV = 12 piezas  
 courbes 1/2 cercle, UC = 12 untiés  
 curvi 1/2 circolo, UV = 12 pezzi



## Chirurgische Nadeln

Surgical Needles

Agujas quirúrgicas

Aiguilles chirurgicales

Aghi chirurgici

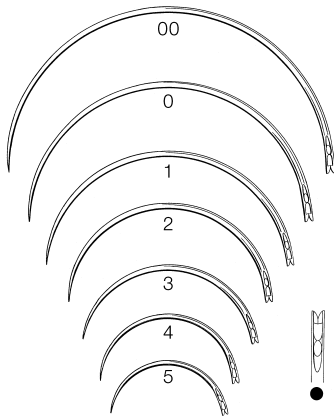
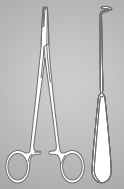
## Naht

Suture

Sutura

Suture

Sutura



|              | Fig. |
|--------------|------|
| 20-175-10-04 | 0    |
| 20-175-20-04 | 00   |
| 20-176-01-04 | 1    |
| 20-176-02-04 | 2    |
| 20-176-03-04 | 3    |
| 20-176-04-04 | 4    |
| 20-176-05-04 | 5    |

gebogen 1/2 Kreis, VE = 12 Stück  
curved, 1/2 circle, SU = 12/pack  
curvas 1/2 círculo, UV = 12 piezas  
courbes 1/2 cercle, UC = 12 untiés  
curvi 1/2 circolo, UV = 12 pezzi

# Mikro-Nadelhalter

Micro Needle Holders

Micro Porta-agujas

Micro porte-aiguilles

Micro Portaghi



1/1



1/2

20-002-15-07 -  
20-019-18-09

|                |    | mit Sperre<br>with lock<br>con trinquete<br>avec cran d'arrêt<br>con arresto | mit Sperre<br>with lock<br>con trinquete<br>avec cran d'arrêt<br>con arresto | ohne Sperre<br>w/o lock<br>sin trinquete<br>sans cran d'arrêt<br>senza arresto | ohne Sperre<br>w/o lock<br>sin trinquete<br>sans cran d'arrêt<br>senza arresto |
|----------------|----|--|--|--|--|
|                | Ø  | 0.40 mm  | 0.40 mm  | 0.40 mm  | 0.40 mm  |
| 15 cm / 5 7/8" | St | 20-002-15-07   | 20-003-15-07   | 20-004-15-07   | 20-005-15-07   |
|                | Ti | 20-016-15-09   | 20-017-15-09   | 20-018-15-09   | 20-019-15-09   |
| 18 cm / 7 1/8" | St | 20-002-18-07   | 20-003-18-07   | 20-004-18-07   | 20-005-18-07   |
|                | Ti | 20-016-18-09   | 20-017-18-09   | 20-018-18-09   | 20-019-18-09   |



1/1



1/2

20-010-15-07 -  
20-023-23-09

|                |    | mit Sperre<br>with lock<br>con trinquete<br>avec cran d'arrêt<br>con arresto | mit Sperre<br>with lock<br>con trinquete<br>avec cran d'arrêt<br>con arresto | ohne Sperre<br>w/o lock<br>sin trinquete<br>sans cran d'arrêt<br>senza arresto | ohne Sperre<br>w/o lock<br>sin trinquete<br>sans cran d'arrêt<br>senza arresto |
|----------------|----|--|--|--|--|
|                | Ø  | 0.80 mm  | 0.80 mm  | 0.80 mm  | 0.80 mm  |
| 15 cm / 5 7/8" | St | 20-010-15-07   | 20-011-15-07   | 20-012-15-07   | 20-013-15-07   |
|                | Ti | 20-020-15-09   | 20-021-15-09   | 20-022-15-09   | 20-023-15-09   |
| 18 cm / 7 1/8" | St | 20-010-18-07   | 20-011-18-07   | 20-012-18-07   | 20-013-18-07   |
|                | Ti | 20-020-18-09   | 20-021-18-09   | 20-022-18-09   | 20-023-18-09   |
| 21 cm / 8 2/8" | St | 20-010-21-07   | 20-011-21-07   | 20-012-21-07   | 20-013-21-07   |
|                | Ti | 20-020-21-09   | 20-021-21-09   | 20-022-21-09   | 20-023-21-09   |
| 23 cm / 9"     | St | 20-010-23-07   | 20-011-23-07   | 20-012-23-07   | 20-013-23-07   |
|                | Ti | 20-020-23-09   | 20-021-23-09   | 20-022-23-09   | 20-023-23-09   |

# Mikro-Nadelhalter

Micro Needle Holders  
 Micro Porta-agujas  
 Micro porte-aiguilles  
 Micro Portaghi

# Naht

Suture  
 Sutura  
 Sutura  
 Sutura



1/1



1/2

20-030-15-07 -  
 20-033-23-09

|                |    | mit Sperre<br>with lock<br>con trinquete<br>avec cran d'arrêt<br>con arresto | mit Sperre<br>with lock<br>con trinquete<br>avec cran d'arrêt<br>con arresto | ohne Sperre<br>w/o lock<br>sin trinquete<br>sans cran d'arrêt<br>senza arresto | ohne Sperre<br>w/o lock<br>sin trinquete<br>sans cran d'arrêt<br>senza arresto |
|----------------|----|--|--|--|--|
|                | Ø  | 1.2 mm   | 1.2 mm   | 1.2 mm   | 1.2 mm   |
| 15 cm / 5 7/8" | St | 20-030-15-07   | 20-031-15-07   | 20-032-15-07   | 20-033-15-07   |
|                | Ti | 20-030-15-09   | 20-031-15-09   | 20-032-15-09   | 20-033-15-09   |
| 18 cm / 7 1/8" | St | 20-030-18-07   | 20-031-18-07   | 20-032-18-07   | 20-033-18-07   |
|                | Ti | 20-030-18-09   | 20-031-18-09   | 20-032-18-09   | 20-033-18-09   |
| 21 cm / 8 3/8" | St | 20-030-21-07   | 20-031-21-07   | 20-032-21-07   | 20-033-21-07   |
|                | Ti | 20-030-21-09   | 20-031-21-09   | 20-032-21-09   | 20-033-21-09   |
| 23 cm / 9"     | St | 20-030-23-07   | 20-031-23-07   | 20-032-23-07   | 20-033-23-07   |
|                | Ti | 20-030-23-09   | 20-031-23-09   | 20-032-23-09   | 20-033-23-09   |



1/1



1/2

20-048-18-07 -  
 20-051-18-07

18 cm / 7 1/8"

|                |    | mit Sperre<br>with lock<br>con trinquete<br>avec cran d'arrêt<br>con arresto | mit Sperre<br>with lock<br>con trinquete<br>avec cran d'arrêt<br>con arresto | ohne Sperre<br>without lock<br>sin trinquete<br>sans cran d'arrêt<br>senza arresto | ohne Sperre<br>without lock<br>sin trinquete<br>sans cran d'arrêt<br>senza arresto |
|----------------|----|--|--|--|--|
| 18 cm / 7 1/8" | St | 20-048-18-07   | 20-049-18-07   | 20-050-18-07   | 20-051-18-07   |

20

## Mikro-Nadelhalter

Micro Needle Holders

Micro Porta-agujas

Micro porte-aiguilles

Micro Portaghi



1/2



20-298-10-07  
10,5 cm / 4 1/8"

20-298-11-07  
11,5 cm / 4 5/8"



20-299-10-07  
10,5 cm / 4 1/8"

20-299-11-07  
11,5 cm / 4 5/8"

Barraquer-Troutman  
20-298-10-07 -  
20-299-11-07



1/2

1/1



|                         |    | ohne Sperre<br>w/o ratchet<br>sin trinquete<br>sans cran d'arrêt<br>senza arresto | mit Sperre<br>with ratchet<br>con trinquete<br>avec cran d'arrêt<br>con arresto |
|-------------------------|----|---|---|
| <b>11,5 cm / 4 5/8"</b> | St | 20-300-11-07  | —   |
| <b>13,5 cm / 5 3/8"</b> | St | 20-300-13-07  | 20-300-14-07  |

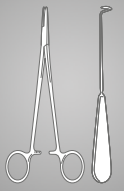
Barraquer  
20-300-11-07 -  
20-300-14-07

## Mikro-Nadelhalter

Micro Needle Holders  
Micro Porta-agujas  
Micro porte-aiguilles  
Micro Portaghi

## Naht

Sutura  
Sutura  
Sutura  
Sutura



Barraquer  
20-301-13-07

13,5 cm / 5 3/8"

sehr feines Maul  
very delicate jaw  
boca muy delicada  
mors très fin  
morso strafino



Castroviejo-Fino  
20-302-01-07

13 cm / 5 1/8"

sehr feines Maul  
very delicate jaw  
boca muy delicada  
mors très fin  
morso strafino



Castroviejo-Fino  
20-303-01-07

13 cm / 5 1/8"

sehr feines Maul  
very delicate jaw  
boca muy delicada  
mors très fin  
morso strafino



Castroviejo-Fino  
20-304-01-07

13 cm / 5 1/8"

sehr feines Maul, mit Sperre  
very delicate jaw, with lock  
boca muy delicada, con cierre  
mors très fin, avec serrure  
morso strafino, con fermo



Castroviejo-Fino  
20-305-01-07

13 cm / 5 1/8"

sehr feines Maul, mit Sperre  
very delicate jaw, with lock  
boca muy delicada, con cierre  
mors très fin, avec serrure  
morso strafino, con fermo



Castroviejo-Fino  
20-303-09-07

9 cm / 3 4/8"



Castroviejo-Fino  
20-304-09-07

9 cm / 3 4/8"

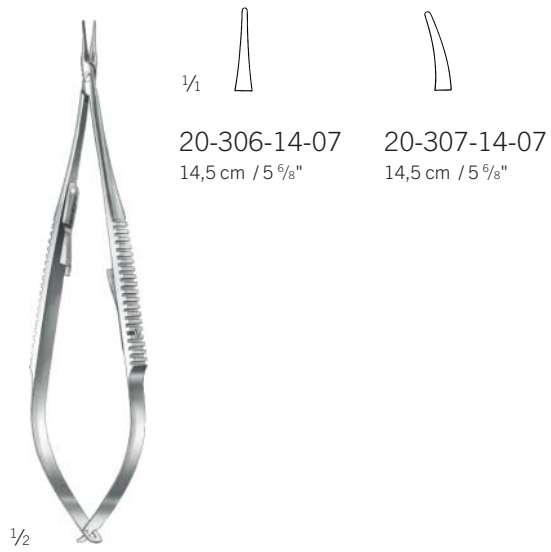
## Mikro-Nadelhalter

Micro Needle Holders

Micro Porta-agujas

Micro porte-aiguilles

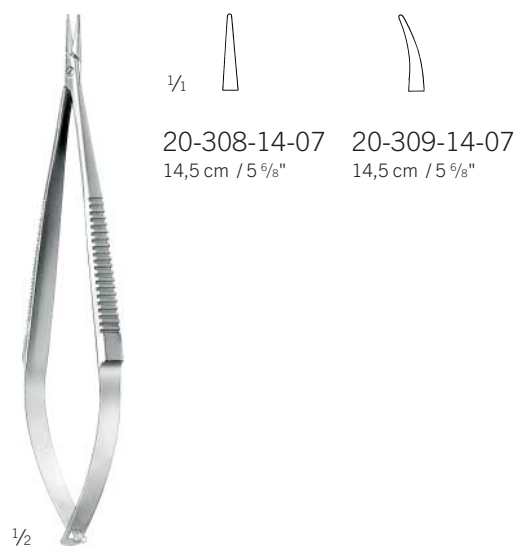
Micro Portaghi



20-306-14-07  
14,5 cm / 5 7/8"

20-307-14-07  
14,5 cm / 5 7/8"

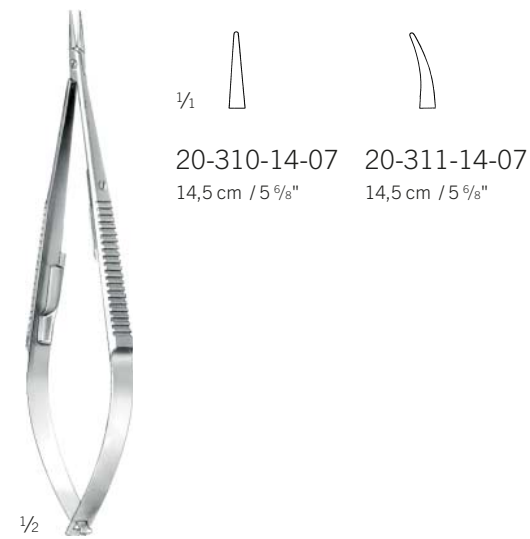
Castroviejo  
20-306-14-07 -  
20-307-14-07



20-308-14-07  
14,5 cm / 5 7/8"

20-309-14-07  
14,5 cm / 5 7/8"

Castroviejo  
20-308-14-07 -  
20-309-14-07



20-310-14-07  
14,5 cm / 5 7/8"

20-311-14-07  
14,5 cm / 5 7/8"

Castroviejo  
20-310-14-07 -  
20-311-14-07



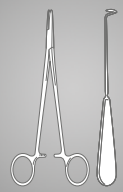
Castroviejo  
20-313-14-07  
14,5 cm / 5 7/8"

## Nadelhalter

Needle Holders  
Porta-agujas  
Porte-aiguilles  
Portaghi

## Naht

Suture  
Sutura  
Suture  
Sutura



1/2



20-326-12-07

12 cm / 4 7/8"

beide Maulteile gefenstert  
both jaws fenestrated  
ambas mordazas fenestradas  
les deux mors fenêtrés  
entrambe le gole a finestra



20-328-12-07

13 cm / 5 1/8"

längsgerieftes Maul  
jaw with longitudinal serration  
boca con estrías longitudi-  
mors avec rainures longitudinales  
morso con strie longitudinali



1/2

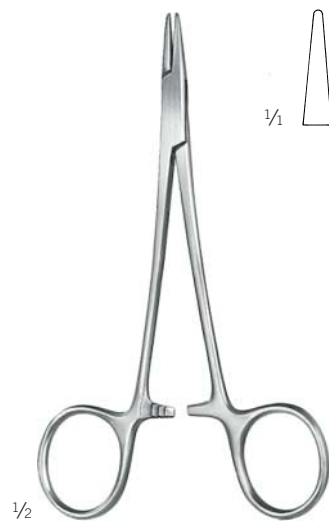


Collier

20-332-12-07

12,5 cm / 4 7/8"

beide Maulteile durchgehend gefenstert  
both jaws totally fenestrated  
ambas mordazas completamente fenestradas  
les deux mors fenêtrés sur toute leur longueur  
entrambe le gole completamente a finestra



1/2



Webster

20-334-13-07

13 cm / 5 1/8"

glattes Maul  
smooth jaw  
boca lisa  
mors lisse  
morso liscio



1/2

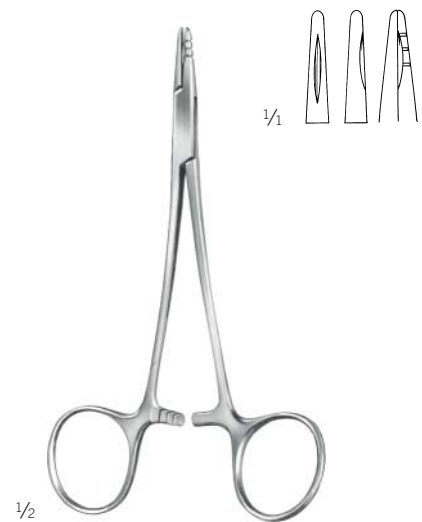


Halsey

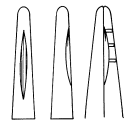
20-336-13-07

13,5 cm / 5 3/8"

glattes Maul  
smooth jaw  
boca lisa  
mors lisse  
morso liscio



1/2



Neivert

20-338-13-07

12,5 cm / 4 7/8"

glattes Maul mit Spezialkehlung  
smooth jaw, special groove  
boca lisa, especialmente acanalada  
mors lisse, avec stries spéciales  
morso liscio con scannellatura speciale

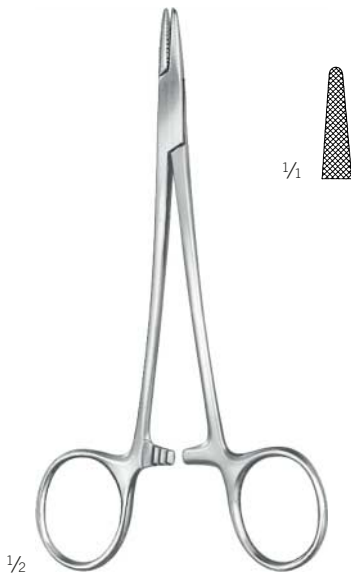
# Nadelhalter

Needle Holders

Porta-agujas

Porte-aiguilles

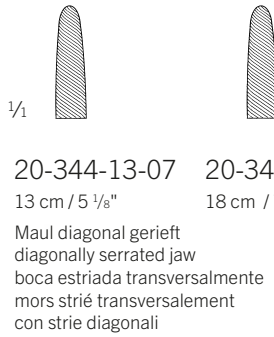
Portaghi



Hegar-Baumgartner  
20-340-14-07  
14,5 cm / 5 7/8"



Brown  
20-344-13-07 -  
20-344-18-07  
kräftiges Modell  
heavy pattern  
modelo fuerte  
modèle fort  
modello forte



20-344-13-07 20-344-18-07  
13 cm / 5 1/8" 18 cm / 7 1/8"  
Maul diagonal gerieft  
diagonally serrated jaw  
boca estriada transversalmente  
mors strié transversalement  
con striae diagonali



Crile-Murray  
20-348-15-07  
15 cm / 5 7/8"  
schlankes Modell  
slender pattern  
modelo delgado  
modèle gracile  
modello delicato



Crile-Wood  
20-350-15-07  
15 cm / 5 7/8"



Adson  
20-360-18-07  
18,5 cm / 7 3/8"  
beide Maulteile durchgehend gefenestert  
both jaws fenestrated throughout  
ambas mordazas completamente fenestradas  
les deux mors fenêtrés sur toute leur longueur  
entrambe le gole completamente a finestra



Metzenbaum  
20-364-18-07  
18,5 cm / 7 3/8"  
ein Maulteil gekehlt und gefenestert  
one grooved and fenestrated jaw  
un lado de la boca acanalado y fenestrado  
un côté de mors strié et fenêtré  
una parte del morso scannellata e fenestrata

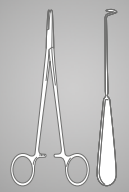


**Nadelhalter**

Needle Holders  
Porta-agujas  
Porte-aiguilles  
Portaghi

**Naht**

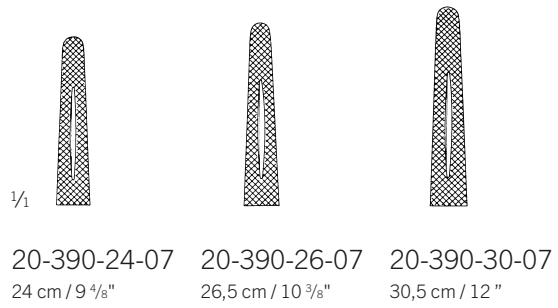
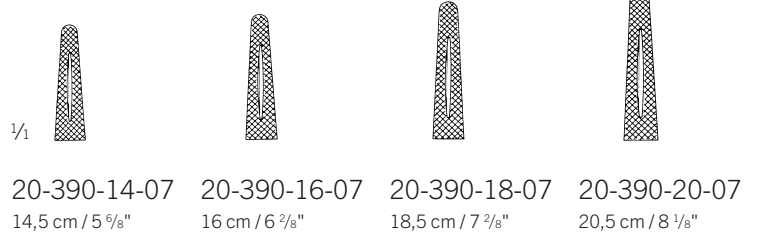
Suture  
Sutura  
Suture  
Sutura



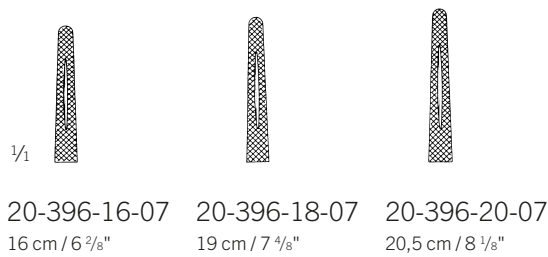
M. G. Hospital  
20-384-17-07  
18 cm / 7 1/8"  
kräftiges Modell  
heavy pattern  
modelo fuerte  
modèle fort  
modello forte



Mayo-Hegar  
20-390-14-07 -  
20-390-30-07



Mayo-Hegar  
20-396-16-07 -  
20-396-20-07  
schlankes Modell  
slender pattern  
modelo delgado  
modèle gracile  
modello delicato



Heaney  
20-403-21-07  
20,5 cm / 8 1/8"

20

## Nadelhalter

Needle Holders

Porta-agujas

Porte-aiguilles

Portaghi



$\frac{1}{2}$

Jameson  
20-404-23-07  
23 cm / 9"



$\frac{1}{2}$

$\frac{1}{2}$

Masson  
20-408-27-07  
26,5 cm / 10  $\frac{3}{8}$ "  
kräftiges Modell  
heavy pattern  
modelo fuerte  
modèle fort  
modello forte



$\frac{1}{2}$

$\frac{1}{2}$

Finochietto  
20-415-27-07  
26,5 cm / 10  $\frac{3}{8}$ "



Wangenstein  
 20-420-27-07  
 26,5 cm / 10 3/8"



Johnson  
 20-437-27-07  
 27 cm / 10 5/8"



Stratte  
 20-451-23-07  
 23 cm / 9"

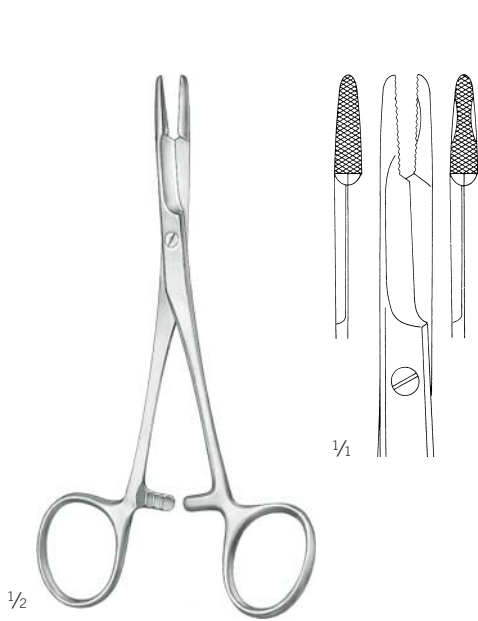
# Nadelhalter

Needle Holders

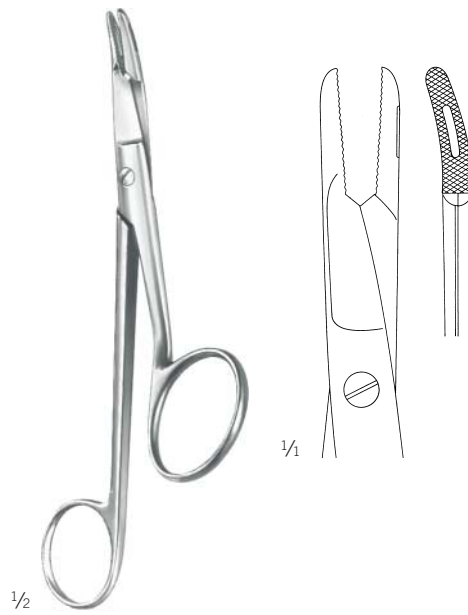
Porta-agujas

Porte-aiguilles

Portaghi



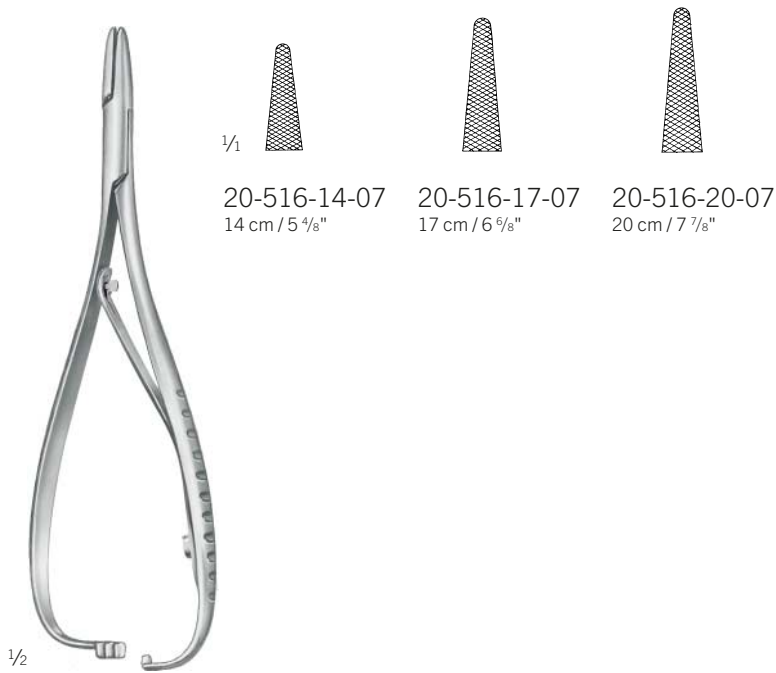
Olsen-Hegar  
20-466-14-07  
14 cm / 5 1/8"



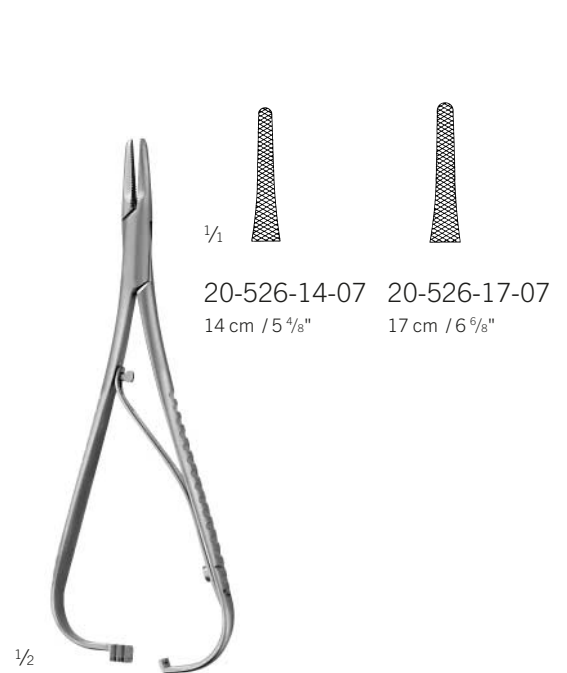
Gillies  
20-469-16-07  
16 cm / 6 2/8"



Crile  
20-500-15-07  
15 cm / 5 7/8"



Mathieu  
20-516-14-07 -  
20-516-20-07



Mathieu  
20-526-14-07 -  
20-526-17-07

schlankes Modell  
slender pattern  
modelo delgado  
modèle gracile  
modello delicato

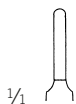
# Mikro-Nadelhalter, Nadelhalter

Micro Needle Holders, Needle Holders  
 Micro Porta-agujas, Porta-agujas  
 Micro porte-aiguilles, Porte-aiguilles  
 Micro Portaghi, Portaghi

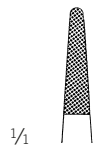
**Naht**  
 Sutura  
 Sutura  
 Sutura  
 Sutura



**TC GOLD**



6-0 - 12-0  
 Smooth



Webster  
 20-604-13-07  
 13 cm / 5 1/8"

Crile-Wood  
 20-604-15-07  
 15 cm / 5 7/8"

4-0 - 6-0  
 Mini

mit Durchdrücksperrung auch für Linkshänder geeignet  
 with automatic release ratchet also for lefthanders  
 con cremallera automática también para zurdos  
 avec crémaillère automatique aussi pour gauchers  
 con cremagliera automatica anche per mancini

Hepp-Scheidel  
 20-602-18-07  
 18,5 cm / 7 3/8"

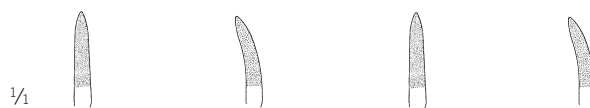
20-604-13-07 -  
 20-604-15-07



safety-wave

diamond-coated

2-0 - 4-0



|                |    | mit Sperre<br>with ratchet<br>con trinquete<br>avec cran d'arrêt<br>con arresto | mit Sperre<br>with ratchet<br>con trinquete<br>avec cran d'arrêt<br>con arresto | ohne Sperre<br>w/o ratchet<br>sin trinquete<br>sans cran d'arrêt<br>senza arresto | ohne Sperre<br>w/o ratchet<br>sin trinquete<br>sans cran d'arrêt<br>senza arresto |
|----------------|----|---|---|---|---|
|                | Ø  | 2.0 mm  | 2.0 mm  | 2.0 mm  | 2.0 mm  |
| 15 cm / 5 7/8" | St | 20-606-15-07  | 20-605-15-07  | 20-608-15-07  | 20-607-15-07  |
| 18 cm / 7 1/8" | St | 20-606-18-07  | 20-605-18-07  | 20-608-18-07  | 20-607-18-07  |
| 21 cm / 8 2/8" | St | 20-606-21-07  | 20-605-21-07  | 20-608-21-07  | 20-607-21-07  |
| 23 cm / 9"     | St | 20-606-23-07  | 20-605-23-07  | 20-608-23-07  | 20-607-23-07  |

**TC GOLD**



5-0 - 8-0  
 Micro

20-605-15-07 -  
 20-608-23-07

Jaboma  
 20-610-18-07  
 18 cm / 7 1/8"

20

## Mikro-Nadelhalter, Nadelhalter

Micro Needle Holders, Needle Holders

Micro Porta-agujas, Porta-agujas

Micro porte-aiguilles, Porte-aiguilles

Micro Portaghi, Portaghi



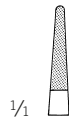
2-0 - 5-0



diamond-coated



safety-wave



1/4



4-0 - 6-0



Mini

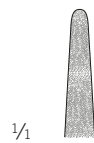
1/2

Par-Style  
20-600-11-07  
11,5 cm / 4 1/2"



1/2

Heavy Duty  
20-613-19-07 -  
20-613-23-07



1/4

20-613-19-07  
19 cm / 7 4/8"



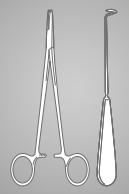
20-613-23-07  
23 cm / 9"

## Mikro-Nadelhalter

Micro Needle Holders  
Micro Porta-agujas  
Micro porte-aiguilles  
Micro Portaghi

## Naht

Sutura  
Sutura  
Sutura  
Sutura



1/2



8-0 - 9-0

1/4



|    |   |   |   |   |   |
|----|---|---|---|---|---|
|    | ● | mit Sperre<br>with ratchet<br>con trinquete<br>avec cran d'arrêt<br>con arresto | mit Sperre<br>with ratchet<br>con trinquete<br>avec cran d'arrêt<br>con arresto | ohne Sperre<br>w/o ratchet<br>sin trinquete<br>sans cran d'arrêt<br>senza arresto | ohne Sperre<br>w/o ratchet<br>sin trinquete<br>sans cran d'arrêt<br>senza arresto |
| ∅  |   | 0.40 mm   | 0.40 mm   | 0.40 mm   | 0.40 mm   |
| St |   | 20-614-02-07  | 20-615-01-07  | 20-614-01-07  | 20-615-02-07  |

20-614-01-07 -  
20-615-02-07  
14,5 cm / 5 7/8"

20



1/2



8-0 - 9-0

1/4



|    |   |   |   |   |   |
|----|---|---|---|---|---|
|    | ● | mit Sperre<br>with ratchet<br>con trinquete<br>avec cran d'arrêt<br>con arresto | ohne Sperre<br>w/o ratchet<br>sin trinquete<br>sans cran d'arrêt<br>senza arresto | ohne Sperre<br>w/o ratchet<br>sin trinquete<br>sans cran d'arrêt<br>senza arresto | mit Sperre<br>with ratchet<br>con trinquete<br>avec cran d'arrêt<br>con arresto |
| ∅  |   | 0.40 mm   | 0.40 mm   | 0.40 mm   | 0.40 mm   |
| St |   | 20-614-04-07  | 20-615-04-07  | 20-614-03-07  | 20-615-03-07  |

20-614-03-07 -  
20-615-04-07  
14,5 cm / 5 7/8"

# Mikro-Nadelhalter

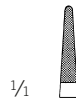
Micro Needle Holders

Micro Porta-agujas

Micro porte-aiguilles

Micro Portaghi

## TC GOLD



1/4

20-620-00-07

14,5 cm / 5 9/16"



5-0 - 8-0



Micro



20-620-01-07

14,5 cm / 5 9/16"



5-0 - 8-0



Micro



20-620-14-07

14,5 cm / 5 9/16"



5-0 - 8-0



Smooth



20-620-18-07

18 cm / 7 1/8"



5-0 - 8-0



Micro



1/4

20-620-21-07

22 cm / 8 5/8"



5-0 - 8-0



Micro



20-621-14-07

14,5 cm / 5 9/16"



5-0 - 8-0



Smooth



20-621-18-07

18 cm / 7 1/8"



5-0 - 8-0



Micro



20-621-21-07

22 cm / 8 5/8"



5-0 - 8-0



Micro



1/2

Castroviejo

20-620-00-07 -

20-621-21-07

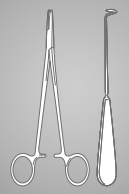


## Mikro-Nadelhalter

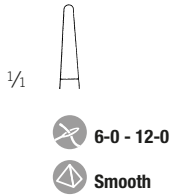
Micro Needle Holders  
Micro Porta-agujas  
Micro porte-aiguilles  
Micro Portaghi

## Naht

Sutura  
Sutura  
Sutura  
Sutura

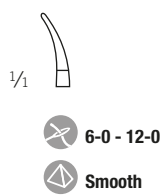


## TC GOLD



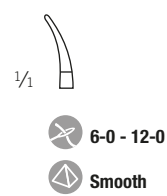
Castroviejo  
20-624-13-07

12,5 cm / 4 7/8"  
mit Sperre  
with lock  
con cierre  
avec serrure  
con fermo



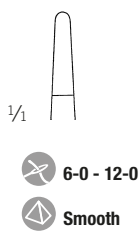
Barraquer  
20-626-13-07

13 cm / 5 1/8"  
mit Sperre  
with lock  
con cierre  
avec serrure  
con fermo



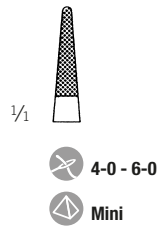
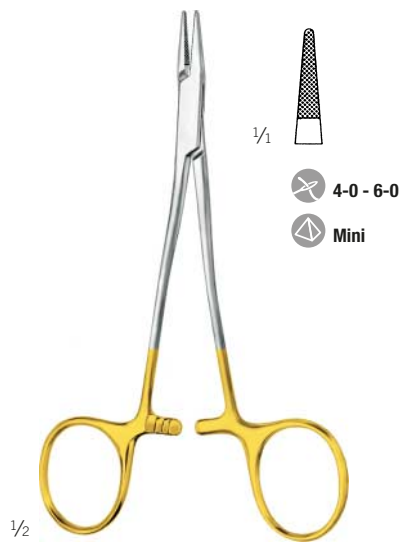
Barraquer  
20-628-13-07

13 cm / 5 1/8"  
ohne Sperre  
w/o ratchet  
sin trinquete  
sans cran d'arrêt  
senza arresto



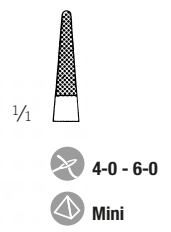
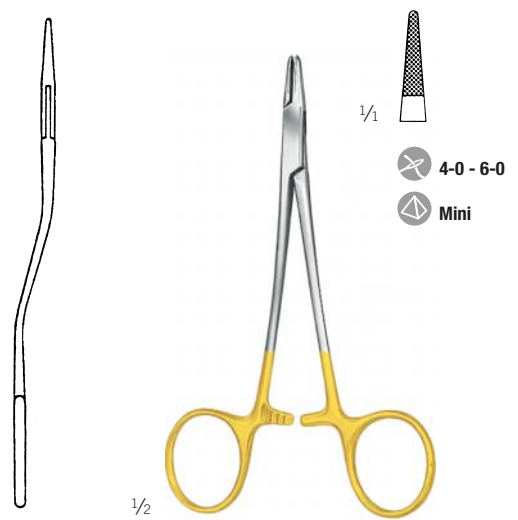
Webster  
20-630-13-07

13 cm / 5 1/8"



Kilner  
20-631-13-07

14,5 cm / 5 6/8"



Derf  
20-632-12-07

12 cm / 4 6/8"

# Nadelhalter

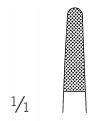
Needle Holders

Porta-agujas

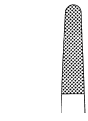
Porte-aiguilles

Portaghi

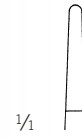
## TC GOLD



20-634-13-07  
13 cm / 5 1/8"



20-634-14-07  
14,5 cm / 5 6/8"



20-636-13-07  
13 cm / 5 1/8"

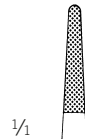


20-637-13-07  
13 cm / 5 1/8"



Hegar-Baumgartner  
20-634-13-07 -  
20-634-14-07

Halsey  
20-636-13-07 -  
20-637-13-07



Webster  
20-637-12-07  
12 cm / 4 6/8"

Crile-Wood  
20-638-15-07  
15 cm / 5 7/8"

Crile-Wood  
20-638-20-07  
20,5 cm / 8 1/8"

# Nadelhalter

Needle Holders

Porta-agujas

Porte-aiguilles

Portaghi

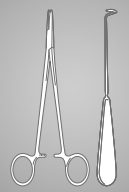
# Naht

Suture

Sutura

Suture

Sutura

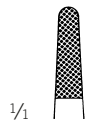


## TC GOLD



1/2

Sarot  
20-640-18-07 -  
20-640-26-07



1/1

20-640-18-07  
18 cm / 7 1/8"



0-6 - 4-0



Standard



20-640-20-07  
20 cm / 7 7/8"



0-6 - 4-0



Standard



20-640-26-07  
26 cm / 10 2/8"



0-6 - 4-0



Standard



1/2

Mayo-Hegar  
20-642-16-07 -  
20-642-30-07



1/1

20-642-16-07  
16 cm / 6 2/8"



0-6 - 4-0



Standard



20-642-18-07  
18,5 cm / 7 2/8"



0-6 - 4-0



Standard



20-642-20-07  
20 cm / 7 7/8"



0-6 - 4-0



Standard



1/1

20-642-24-07  
24 cm / 9 4/8"



0-6 - 4-0



Standard



20-642-26-07  
26,5 cm / 10 3/8"



0-6 - 4-0



Standard



20-642-30-07  
30 cm / 11 6/8"



0-6 - 4-0



Standard

# Nadelhalter

Needle Holders

Porta-agujas

Porte-aiguilles

Portaghi

## TC GOLD



1/2

Heaney  
20-643-20-07 -  
20-643-26-07



1/1

20-643-20-07  
20,5 cm / 8 1/8"

0-6 - 4-0

Standard



20-643-24-07  
24 cm / 9 4/8"

0-6 - 4-0

Standard



20-643-26-07  
26,5 cm / 10 3/8"

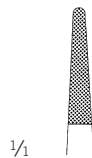
0-6 - 4-0

Standard



1/2

DeBakey  
20-646-18-07 -  
20-646-31-07



1/1

20-646-18-07  
18 cm / 7 1/8"

4-0 - 6-0

Mini



20-646-20-07  
20,5 cm / 8 1/8"

4-0 - 6-0

Mini



20-646-23-07  
23 cm / 9"

4-0 - 6-0

Mini



1/1

20-646-26-07  
26,5 cm / 10 3/8"

4-0 - 6-0

Mini



20-646-31-07  
31 cm / 12 2/8"

4-0 - 6-0

Mini



1/2

Masson  
20-648-27-07  
26,5 cm / 10 3/8"



1/1

0-6 - 4-0

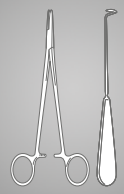
Standard

# Nadelhalter

Needle Holders  
Porta-agujas  
Porte-aiguilles  
Portaghi

# Naht

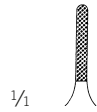
Suture  
Sutura  
Suture  
Sutura



## TC GOLD



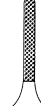
Ryder (Martin)  
20-650-13-07 -  
20-650-26-07



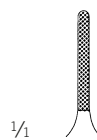
20-650-13-07  
12,5 cm / 4 7/8"



20-650-15-07  
15 cm / 5 7/8"



20-650-18-07  
18 cm / 7 1/8"



20-650-20-07  
20 cm / 7 7/8"



20-650-23-07  
23 cm / 9"



20-650-26-07  
26 cm / 10 3/8"

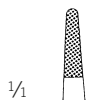


Finochietto  
20-653-27-07  
26,5 cm / 10 3/8"  
Normalprofil  
standard profile  
perfil estándar  
profil normal  
profilo normale



Martin  
20-652-15-07 -  
20-652-20-07

elastisches Modell  
elastic tip  
modelo elástico  
modèle souple  
modello molle



20-652-15-07  
15 cm / 5 7/8"



20-652-17-07  
17 cm / 6 5/8"



20-652-20-07  
20,5 cm / 8 1/8"



# Nadelhalter
























Needle Holders

Porta-agujas

Porte-aiguilles

Portaghi

## TC GOLD

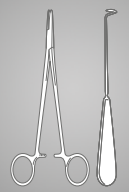
|   |  |  |  |   |  |
|---|--|--|--|---|--|
|  <p>1/2</p>   |  <p>1/1</p>         |                     |                   |  <p>1/2</p> |  |
|   | <p>20-654-13-07<br/>12 cm / 4 5/8"</p>   | <p>20-654-15-07<br/>15,5 cm / 6 1/8"</p>   | <p>20-654-18-07<br/>17,5 cm / 6 7/8"</p>   |   |  <p>1/1</p>       |
|   |  <b>5-0 - 8-0</b>   |  <b>5-0 - 8-0</b>   |  <b>5-0 - 8-0</b> |   |  <b>0-6 - 4-0</b> |
|   |  <b>Micro</b>       |  <b>Micro</b>       |  <b>Micro</b>     |   |  <b>Standard</b>  |
|   |  <p>1/1</p>       |                   |                 |   |  |
|   | <p>20-654-20-07<br/>20 cm / 7 7/8"</p>   | <p>20-654-23-07<br/>22,5 cm / 8 7/8"</p>   | <p>20-654-26-07<br/>26 cm / 10 2/8"</p>  |   |  |
|  <b>5-0 - 8-0</b>  |  <b>5-0 - 8-0</b> |  <b>5-0 - 8-0</b> |  |   |  |
|  <b>Micro</b>  |  <b>Micro</b>     |  <b>Micro</b>     |  |   |  |
| <p>Ryder-Vascular<br/>20-654-13-07 -<br/>20-654-26-07</p> <p>schlankes Modell<br/>delicate pattern<br/>modelo delgado<br/>modèle gracile<br/>modelo gracile</p> |  |  |  | <p>Wangenstein<br/>20-656-27-07<br/>27 cm / 10 5/8"</p>   |  |

**Nadelhalter**

Needle Holders  
Porta-agujas  
Porte-aiguilles  
Portaghi

**Naht**

Suture  
Sutura  
Suture  
Sutura















**TC GOLD**



1/2













Hegar-Vascular  
20-658-14-07 -  
20-658-23-07

|  |  |  |  |
|--|--|--|--|
|                   |                   |                  |                   |
| 20-658-14-07<br>14 cm / 5 4/8"   | 20-658-18-07<br>18,5 cm / 7 3/8"   | 20-658-20-07<br>20,5 cm / 8 1/8"   | 20-658-23-07<br>23 cm / 9"   |
|  <b>5-0 - 8-0</b> |  <b>5-0 - 8-0</b> |  <b>5-0 - 8-0</b> |  <b>5-0 - 8-0</b> |
|  <b>Micro</b>     |  <b>Micro</b>     |  <b>Micro</b>     |  <b>Micro</b>     |



1/2







Bozemann  
20-659-20-07 -  
20-659-28-07

|  |  |
|--|--|
|                   |                    |
| 20-659-20-07<br>20,5 cm / 8 1/8"   | 20-659-24-07<br>24 cm / 9 4/8"   |
|  <b>0-6 - 4-0</b> |  <b>0-6 - 4-0</b> |
|  <b>Standard</b>  |  <b>Standard</b>  |
|                   |                   |
| 20-659-26-07<br>26 cm / 10 4/8"  | 20-659-28-07<br>30 cm / 11 6/8"  |
|  <b>0-6 - 4-0</b> |  <b>0-6 - 4-0</b> |
|  <b>Standard</b>  |  <b>Standard</b>  |



1/2

Hegar  
20-662-20-07 -  
20-662-24-07

|  |  |
|--|--|
|                   |                   |
| 20-662-20-07<br>20 cm / 7 7/8"   | 20-662-24-07<br>24 cm / 9 4/8"   |
|  <b>0-6 - 4-0</b> |  <b>0-6 - 4-0</b> |
|  <b>Standard</b>  |  <b>Standard</b>  |

20

# Nadelhalter

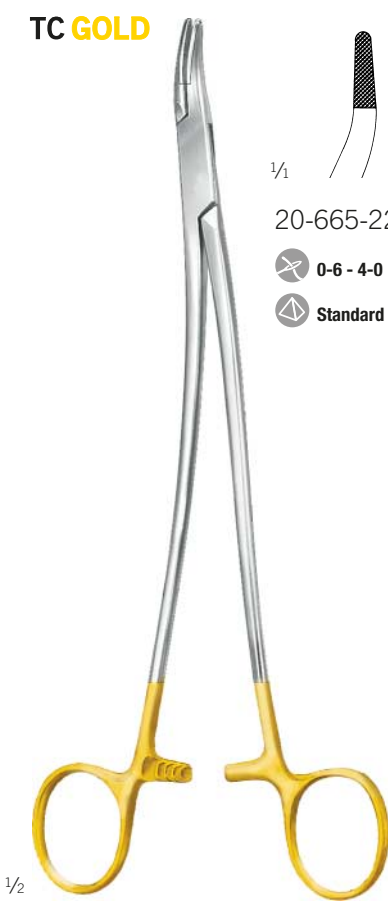
Needle Holders

Porta-agujas

Porte-aiguilles

Portaghi

## TC GOLD



- 1/1
- 20-665-22-07
  - 20-665-23-07
  - 0-6 - 4-0
  - Standard



- 1/1
- 20-666-00-07
  - 14 cm / 5 4/8"
  - 5-0 - 8-0
  - Micro
- 20-666-02-07

17,5 cm / 6 7/8"

  - 5-0 - 8-0
  - Micro

20-666-03-07

20 cm / 7 7/8"

  - 5-0 - 8-0
  - Micro

20-666-04-07

23 cm / 9"

  - 5-0 - 8-0
  - Micro

20-666-05-07

26 cm / 10 2/8"

  - 5-0 - 8-0
  - Micro

Stratte  
20-665-22-07 -  
20-665-23-07  
23 cm / 9"

Microvascular  
20-666-00-07 -  
20-666-05-07



- 1/1
- 20-668-00-07
  - 14 cm / 5 4/8"
  - 5-0 - 8-0
  - Smooth
- 20-668-01-07
  - 15 cm / 5 7/8"
  - 5-0 - 8-0
  - Smooth
- 20-668-02-07
  - 17,5 cm / 6 7/8"
  - 5-0 - 8-0
  - Smooth
- 20-668-03-07
  - 20 cm / 7 7/8"
  - 5-0 - 8-0
  - Smooth

Martini  
20-668-00-07 -  
20-668-03-07



## Nadelhalter

Needle Holders

Porta-agujas

Porte-aiguilles

Portaghi

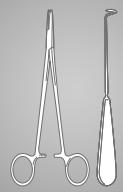
## Naht

Suture

Sutura

Suture

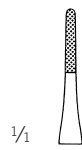
Sutura



## TC GOLD



1/2



1/4

20-670-00-07

14 cm / 5 4/8"



5-0 - 8-0

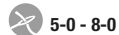


Micro



20-670-01-07

15 cm / 5 7/8"



5-0 - 8-0



Micro



20-670-02-07

17,5 cm / 6 7/8"



5-0 - 8-0



Micro



20-670-03-07

20 cm / 7 7/8"



5-0 - 8-0



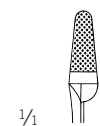
Micro

Martini  
20-670-00-07 -  
20-670-03-07

schlankes Modell  
delicate pattern  
modelo delgado  
modèle gracile  
modelo gracile



1/2



1/4

20-672-14-07

14,5 cm / 5 7/8"



0-6 - 4-0



Standard



20-672-17-07

17 cm / 6 5/8"



0-6 - 4-0



Standard



20-672-18-07

19 cm / 7 4/8"



0-6 - 4-0



Standard

Olsen Hegar  
20-672-14-07 -  
20-672-18-07

Normalprofil  
standard profile  
perfil estándar  
profil normal  
profilo normale

# Nadelhalter

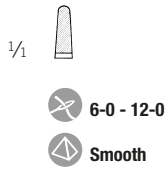
Needle Holders

Porta-agujas

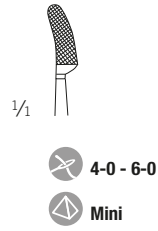
Porte-aiguilles

Portaghi

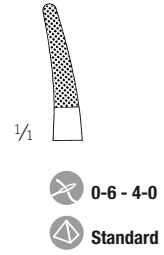
## TC GOLD



1/2  
Foster-Gillies  
20-673-12-07  
11 cm / 4 3/8"



1/2  
Gillies-Mini  
20-673-15-07  
15 cm / 5 7/8"



1/2  
Gillies  
20-673-16-07  
16 cm / 6 2/8"



1/2  
Mathieu  
20-674-14-07 -  
20-674-20-07

## Nadelhalter

Needle Holders

Porta-agujas

Porte-aiguilles

Portaghi

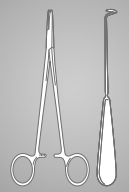
## Naht

Suture

Sutura

Suture

Sutura



## TC GOLD



1/2

Mathieu  
20-676-14-07 -  
20-676-20-07



1/4

20-676-14-07  
14 cm / 5 4/8"



0-6 - 4-0



Standard



20-676-17-07  
17 cm / 6 6/8"



0-6 - 4-0



Standard



20-676-20-07  
20 cm / 7 7/8"



0-6 - 4-0

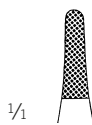


Standard



1/2

Mathieu  
20-678-17-07 -  
20-678-20-07  
mit Innensperre  
with interior ratchet  
con cremallera interior  
avec crémaillère interne  
con cremagliera interna



1/4

20-678-17-07  
17 cm / 6 6/8"



0-6 - 4-0



Standard



20-678-20-07  
20 cm / 7 7/8"



0-6 - 4-0



Standard



1/2

Toennis  
20-684-18-07  
18 cm / 7 1/8"



1/4



0-6 - 4-0



Standard

20

# Nadelhalter

Needle Holders

Porta-agujas

Porte-aiguilles

Portaghi

## TC GOLD



1/2  
Kübler  
20-685-18-07  
18 cm / 7 1/8"



1/2  
Langenbeck  
20-692-18-07 -  
20-692-23-07

20-692-18-07  
18,5 cm / 7 2/8"

20-692-20-07  
20,5 cm / 8 1/8"

20-692-23-07  
23 cm / 9"

0-6 - 4-0  
Standard

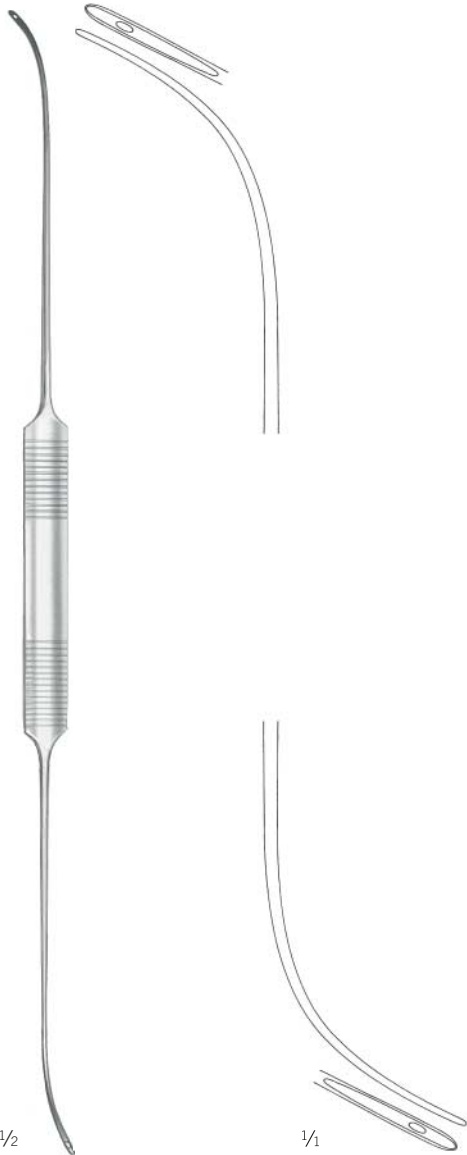
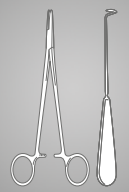
0-6 - 4-0  
Standard

0-6 - 4-0  
Standard

## Unterbindungsnadeln

Ligature Needles  
Agujas para ligaduras  
Aiguilles à ligatures  
Aghi per legatura

Naht  
Suture  
Sutura  
Suture  
Sutura



1/2

1/1

Schmieden-Dick  
20-813-32-07

30 cm / 11 5/8"

biegsam  
malleable  
maleable  
malléable  
malleabili



1/2

1/1

Schmieden  
20-815-21-07

24 cm / 9 4/8"

## Unterbindungsnadeln

Ligature Needles

Agujas para ligaduras

Aiguilles à ligatures

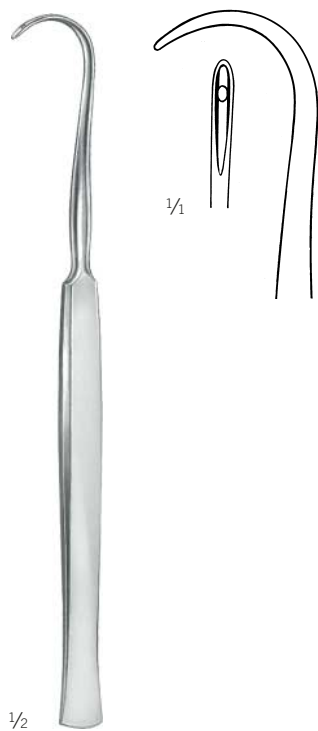
Aghi per legatura



20-825-20-07

20 cm / 7 7/8"

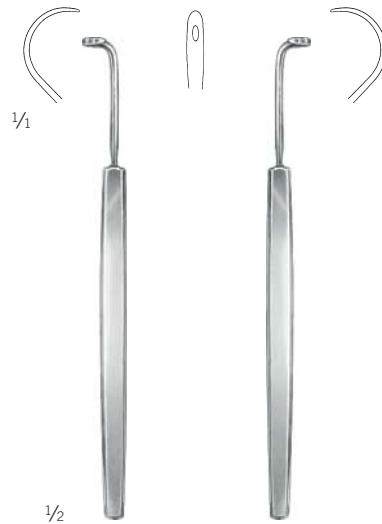
biegsam  
malleable  
maleable  
malléable  
malleabili



Cooper

20-832-19-07

20 cm / 7 7/8"



Kronecker

20-835-13-07

12 cm / 4 6/8"

fein, für die rechte Hand  
delicate, for right hand  
fina, para la mano derecha  
fine, pour la main droite  
fino, per la mano destra

Kronecker

20-837-13-07

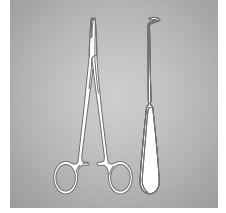
12 cm / 4 6/8"

fein, für die linke Hand  
delicate, for left hand  
fina, para la mano izquierda  
fine, pour la main gauche  
fino, per la mano sinistra

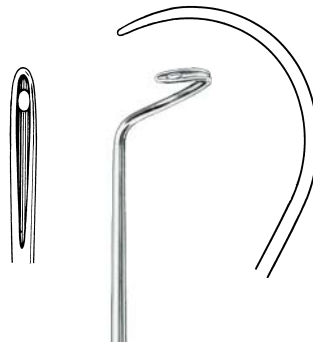
# Unterbindungsnadeln

Ligature Needles  
 Agujas para ligaduras  
 Aiguilles à ligatures  
 Aghi per legatura

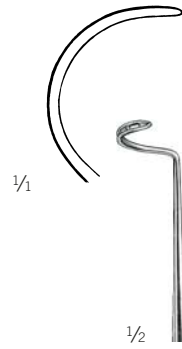
Naht  
 Suture  
 Sutura  
 Suture  
 Sutura



20-839-24-07  
 24 cm / 9 4/8"  
 stumpf, für die rechte Hand  
 blunt, for right hand  
 roma para la mano derecha  
 mousse, pour la main droite  
 smusso, per la mano destra



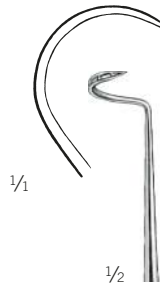
20-840-24-07  
 24 cm / 9 4/8"  
 stumpf, für die linke Hand  
 blunt, for left hand  
 roma para la mano izquierda  
 mousse, pour la main gauche  
 smusso, per la mano sinistra



20-841-20-07  
 20 cm / 7 7/8"  
 stumpf, für die rechte Hand  
 blunt, for right hand  
 roma para la mano derecha  
 mousse, pour la main droite  
 smusso, per la mano destra



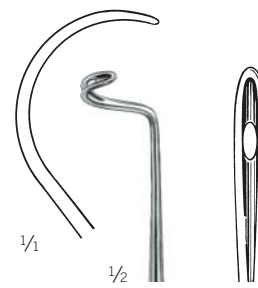
20-842-20-07  
 20 cm / 7 7/8"  
 stumpf, für die linke Hand  
 blunt, for left hand  
 roma para la mano izquierda  
 mousse, pour la main gauche  
 smusso, per la mano sinistra



20-843-20-07  
 20 cm / 7 7/8"  
 scharf, für die rechte Hand  
 sharp, for right hand  
 aguda para la mano derecha  
 aiguë, pour la main droite  
 acuto, per la mano destra



20-844-20-07  
 20 cm / 7 7/8"  
 scharf, für die linke Hand  
 sharp, for left hand  
 aguda para la mano izquierda  
 aiguë, pour la main gauche  
 acuto, per la mano sinistra

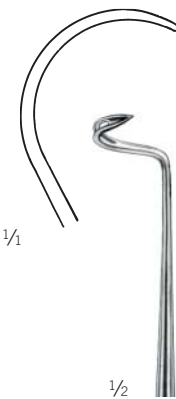


20-845-21-07  
 20 cm / 7 7/8"  
 stumpf, für die rechte Hand  
 blunt, for right hand  
 roma para la mano derecha  
 mousse, pour la main droite  
 smusso, per la mano destra

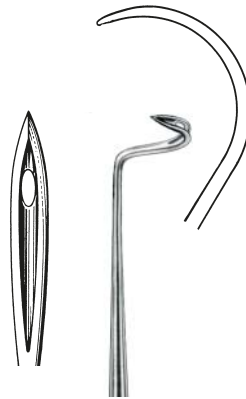


20-846-21-07  
 20 cm / 7 7/8"  
 stumpf, für die linke Hand  
 blunt, for left hand  
 roma para la mano izquierda  
 mousse, pour la main gauche  
 smusso, per la mano sinistra

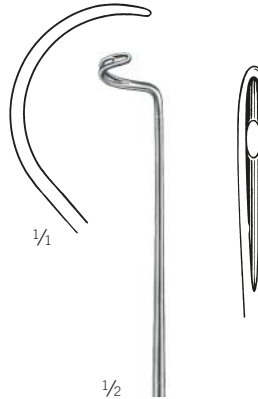
1/2  
 Deschamps  
 20-839-24-07-  
 20-860-20-07



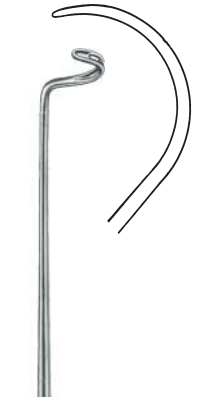
20-847-21-07  
 20 cm / 7 7/8"  
 scharf, für die rechte Hand  
 sharp, for right hand  
 aguda para la mano derecha  
 aiguë, pour la main droite  
 acuto, per la mano destra



20-848-21-07  
 20 cm / 7 7/8"  
 scharf, für die linke Hand  
 sharp, for left hand  
 aguda para la mano izquierda  
 aiguë, pour la main gauche  
 acuto, per la mano sinistra



20-849-27-07  
 27 cm / 10 5/8"  
 stumpf, für die rechte Hand  
 blunt, for right hand  
 roma para la mano derecha  
 mousse, pour la main droite  
 smusso, per la mano destra



20-850-27-07  
 27 cm / 10 5/8"  
 stumpf, für die linke Hand  
 blunt, for left hand  
 roma para la mano izquierda  
 mousse, pour la main gauche  
 smusso, per la mano sinistra

20

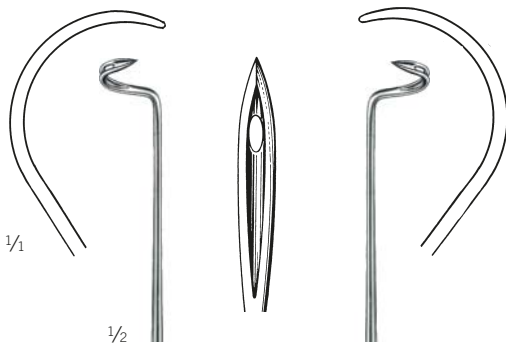
## Unterbindungsnadeln

Ligature Needles

Agujas para ligaduras

Aiguilles à ligatures

Aghi per legatura



20-851-27-07

27 cm / 10 5/8"

scharf, für die rechte Hand  
sharp, for right hand  
aguda para la mano derecha  
aiguë, pour la main droite  
acuto, per la mano destra

20-852-27-07

27 cm / 10 5/8"

scharf, für die linke Hand  
sharp, for left hand  
aguda para la mano izquierda  
aiguë, pour la main gauche  
acuto, per la mano sinistra



20-853-28-07

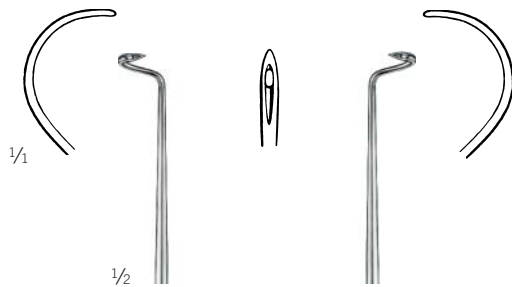
28 cm / 11"

stumpf, für die rechte Hand  
blunt, for right hand  
roma para la mano derecha  
mousse, pour la main droite  
smusso, per la mano destra

20-854-28-07

28 cm / 11"

stumpf, für die linke Hand  
blunt, for left hand  
roma para la mano izquierda  
mousse, pour la main gauche  
smusso, per la mano sinistra



20-855-20-07

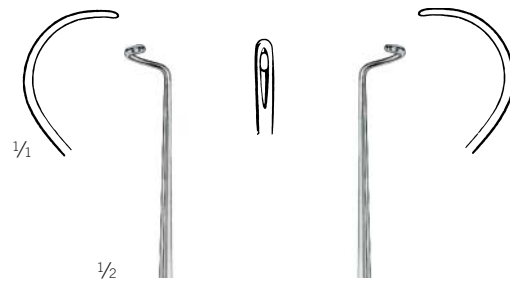
21 cm / 8 2/8"

scharf, für die rechte Hand  
sharp, for right hand  
aguda para la mano derecha  
aiguë, pour la main droite  
acuto, per la mano destra

20-856-20-07

21 cm / 8 2/8"

scharf, für die linke Hand  
sharp, for left hand  
aguda para la mano izquierda  
aiguë, pour la main gauche  
acuto, per la mano sinistra



20-857-20-07

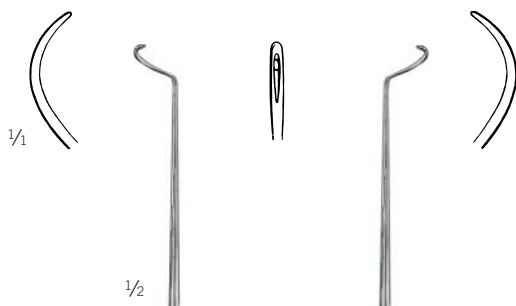
21 cm / 8 2/8"

stumpf, für die rechte Hand  
blunt, for right hand  
roma para la mano derecha  
mousse, pour la main droite  
smusso, per la mano destra

20-858-20-07

21 cm / 8 2/8"

stumpf, für die linke Hand  
blunt, for left hand  
roma para la mano izquierda  
mousse, pour la main gauche  
smusso, per la mano sinistra



20-859-20-07

21 cm / 8 2/8"

stumpf, für die rechte Hand  
blunt, for right hand  
roma para la mano derecha  
mousse, pour la main droite  
smusso, per la mano destra

20-860-20-07

21 cm / 8 2/8"

stumpf, für die linke Hand  
blunt, for left hand  
roma para la mano izquierda  
mousse, pour la main gauche  
smusso, per la mano sinistra



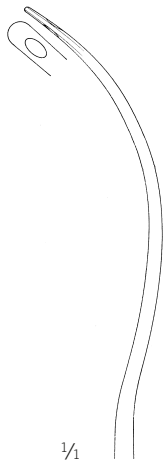
# Unterbindungsnadeln, Führungshohlsonden

Ligature Needles, Ligature Conductors  
Agujas para ligaduras, Sondas conductoras  
Aiguilles à ligatures, Sondes conductrices  
Aghi per legatura, Sonde conduttrici

Naht  
Suture  
Sutura  
Suture  
Sutura

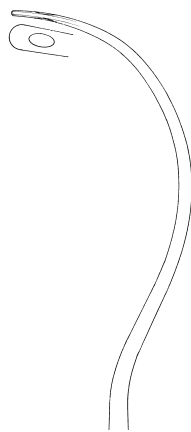


1/2

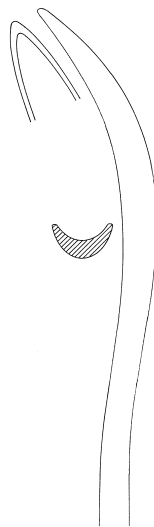


1/4

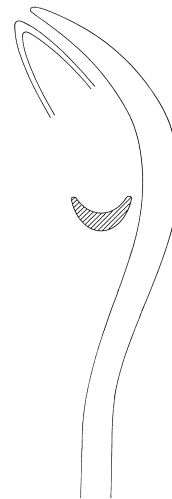
**Fig. 1**  
20-861-30-07



**Fig. 2**  
20-862-30-07



**Fig. 1**  
20-863-30-07

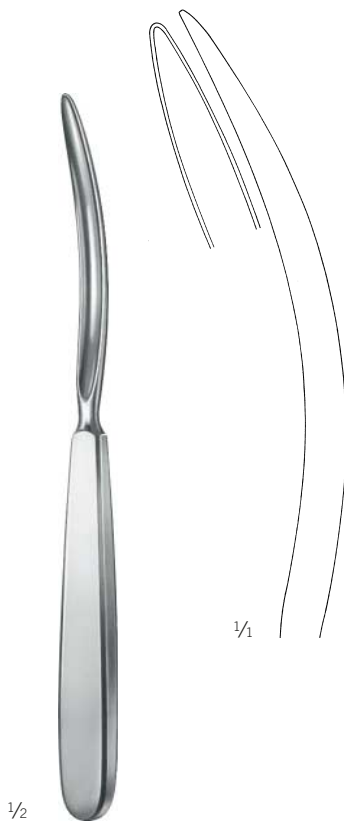


**Fig. 2**  
20-864-30-07

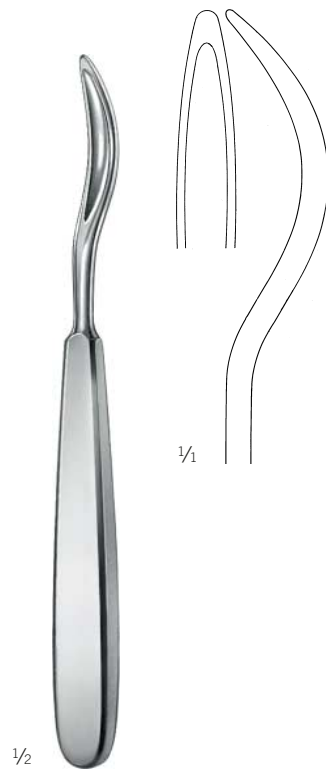
Brunner  
20-861-30-07 -  
20-864-30-07  
30 cm / 11 6/8"

## Führungshohlsonden

Ligature Conductors  
Sondas conductoras  
Sondes conductrices  
Sonde conduttrici



Mod. Martin  
20-867-25-07  
19,5 cm / 7 5/8"



Schmieden  
20-871-19-07  
18 cm / 7 1/8"

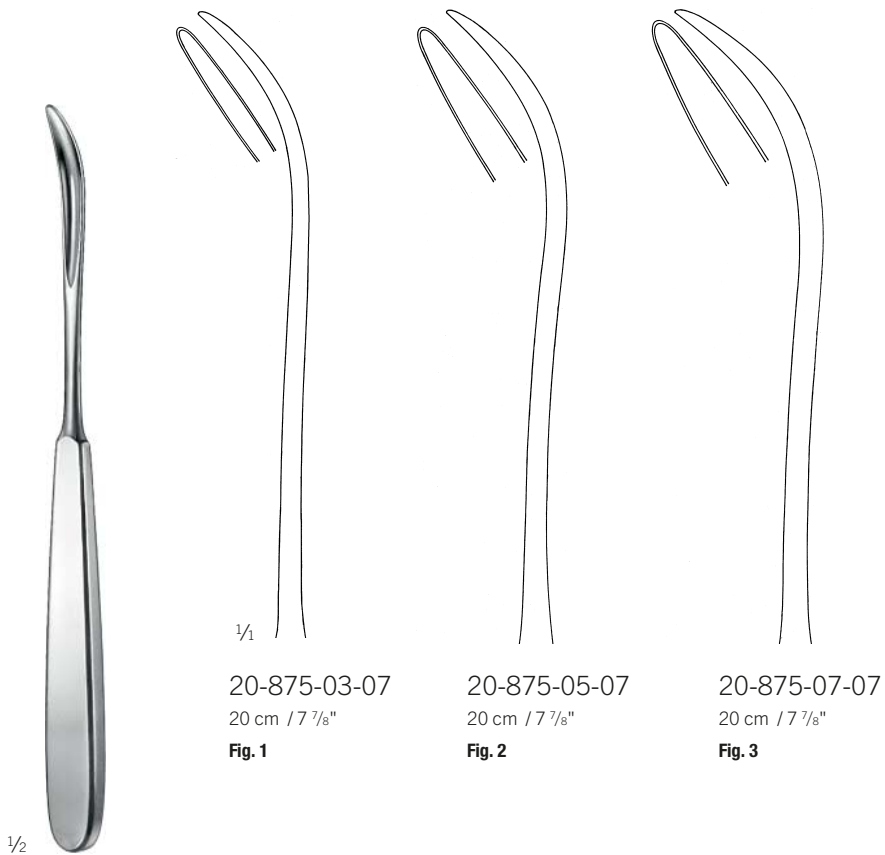
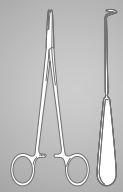


Schmieden-Payr  
20-872-19-07  
18 cm / 7 1/8"

## Führungshohlsonden

Ligature Conductors  
Sondas conductoras  
Sondes conductrices  
Sonde conduttrici

Naht  
Suture  
Sutura  
Suture  
Sutura



König  
20-875-03-07 -  
20-875-07-07

20

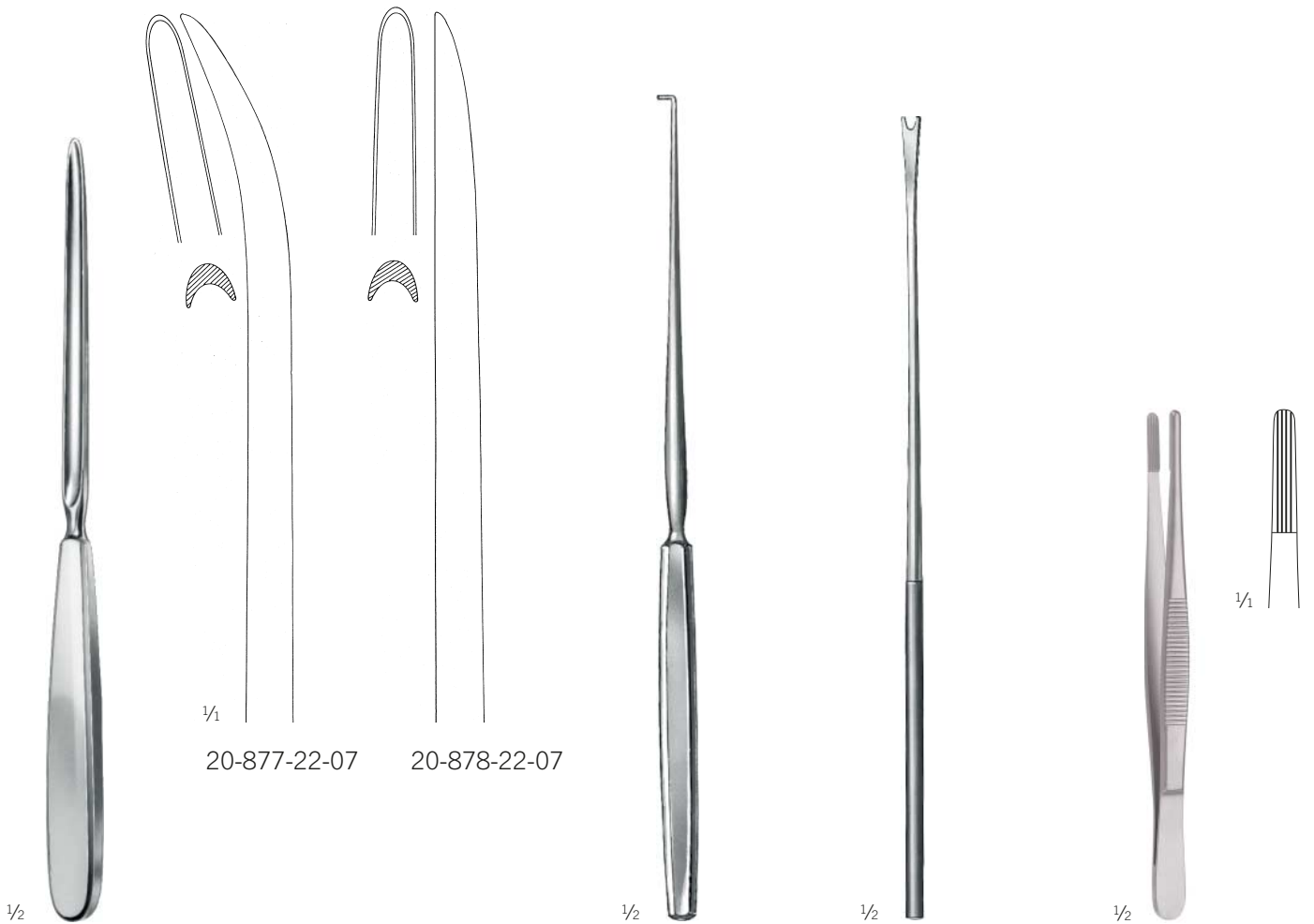
## Führungshohlsonden, Fadenfänger, Fadengabel, Fadenpinzette

Ligature Conductors, Ligature Catcher, Ligature Adjuster, Thread forceps

Sondas conductoras, Captador de hilos, Horquilla de hilos, Pinzas para ligaduras

Sondes conductrices, Porte-ligature, Pousse-fil, Pince à fil

Sonde conduttrici, Portalegature, Forchetta da sutura, Pinze porta-filo



Payr  
20-877-22-07 -  
20-878-22-07  
22 cm / 8<sup>5</sup>/<sub>8</sub>"

Modell Wien  
20-882-23-07  
23,5 cm / 9<sup>2</sup>/<sub>8</sub>"  
Fadenfänger  
Ligature Catcher  
Captador de hilos  
Porte-ligature  
Portalegature

20-886-23-07  
23 cm / 9"  
Fadengabel  
Ligature Adjuster  
Horquilla de hilos  
Pousse-fil  
Forchetta da sutura

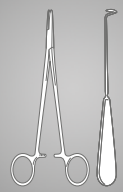
Ochsner  
20-894-14-07  
14,5 cm / 5<sup>6</sup>/<sub>8</sub>"  
Fadenpinzette  
Thread forceps  
Pinzas para ligaduras  
Pince à fil  
Pinze porta-filo

## Wundklammerpinzetten

Clip Applying Forceps  
Pinzas aplicadoras para agrafes  
Pincès à poser les agrafes  
Pinze per applicare le agrafe

## Naht

Suture  
Sutura  
Suture  
Sutura



1/2

**Childe**  
20-910-18-07  
17 cm / 6 5/8"

Wundrandpinzette  
Approximation Forceps  
Pinza aproximadora  
Pincès à poser les agrafes  
Pinza per i margini della ferita  
kräftig, mit Klammerschiene  
heavy pattern, with clip holder  
modelo fuerte, con barra para agrafes  
modèle fort, avec porte-agrafe  
modello forte, con portaagrafe



1/2

**Michel**  
20-916-12-07  
12 cm / 4 5/8"



1/2

**Hegenbarth**  
20-922-12-07  
12 cm / 4 5/8"



1/2

**Wachenfeldt**  
20-924-12-07  
12 cm / 4 5/8"

## Wundklammerzängchen

Clip Applying Forceps

Pinzas aplicadoras para agrafes

Pinces à poser les agrafes

Pinze per applicare le agrafe



Michel  
20-928-12-07  
12,5 cm / 4 7/8"

zum Anlegen und Abnehmen von Klammern  
for applying and removal of clips  
para aplicar y quitar agrafes  
pour appliquer et enlever les agrafes  
per applicare e togliere le agrafes



Michel  
20-929-12-07  
13 cm / 4"

langes Maul, zum Anlegen und Abnehmen  
von Klammern  
long jaw, for applying and removal of clips  
boca larga, para aplicar y quitar agrafes  
pour appliquer et enlever les agrafes  
morso lungo, per applicare e togliere  
le agrafes

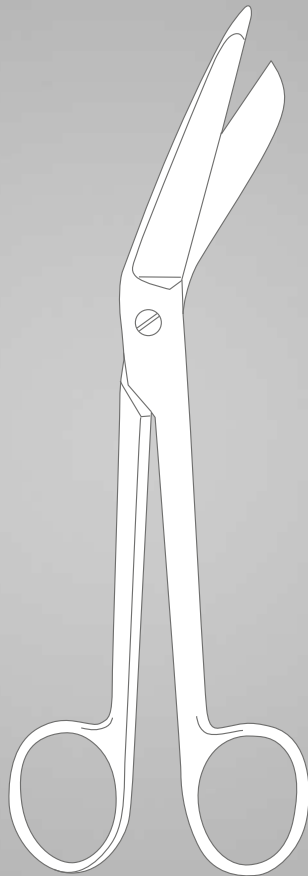


Richter  
20-935-14-07  
13,5 cm / 5 3/8"

mit Schraubschluß  
screw lock  
articulación a tornillo  
articulation à vis  
articulazione a vite

Verband  
Dressings  
Vendajes  
Pansements  
Bendaggi

# 21



## Verbandscheren

Bandage Scissors

Tijeras para vendajes

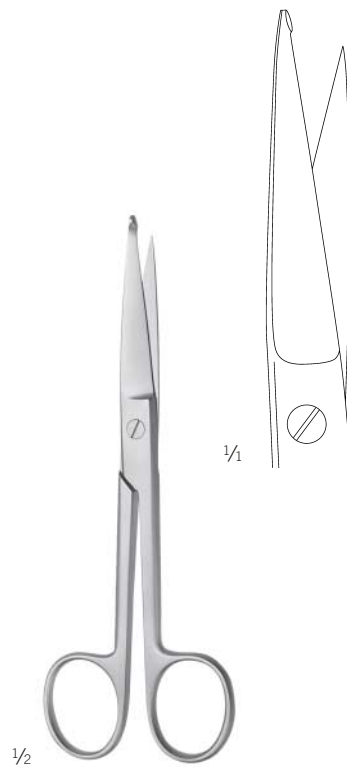
Ciseaux pour pansements

Forbici per bendaggi

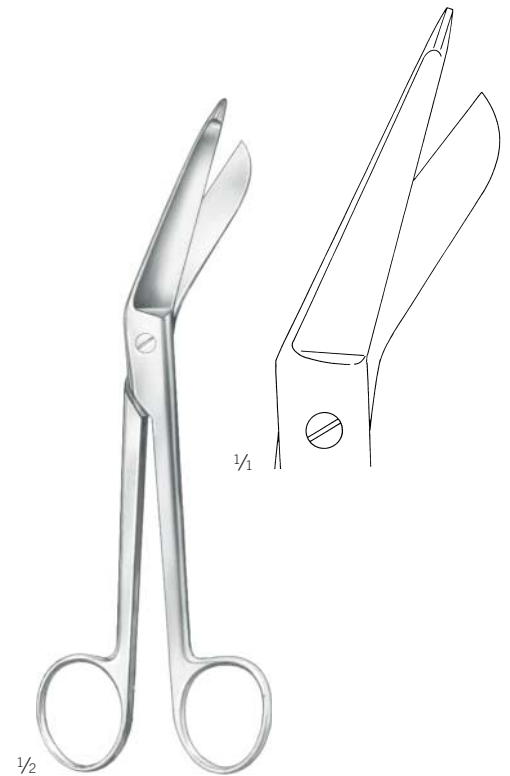


Lorenz  
21-155-23-07  
24 cm / 9 3/8"

kräftiges Modell  
heavy pattern  
modelo fuerte  
modèle fort  
modello forte



21-160-14-07  
14,5 cm / 5 7/8"



Lister  
21-165-14-07 -  
21-165-20-07

21-165-14-07 14,5 cm / 5 7/8"

21-165-18-07 18,5 cm / 7 3/8"

21-165-20-07 20 cm / 7 7/8"

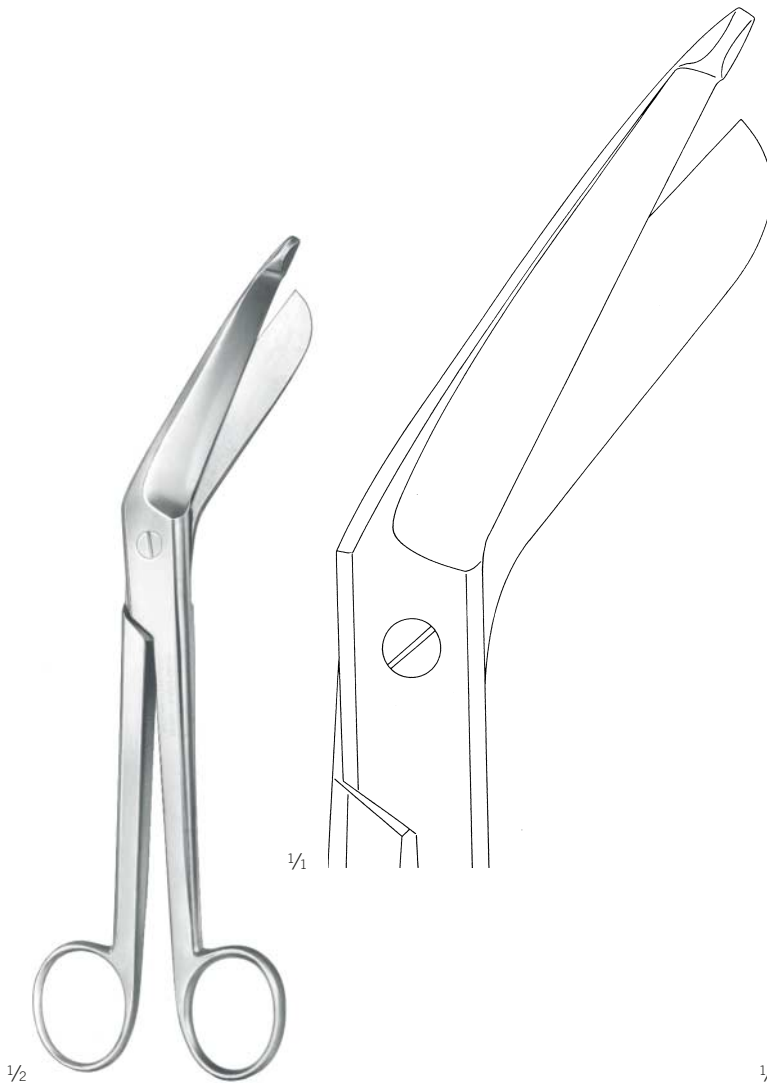


## Gipsscheren

Plaster Shears  
Tijeras para yeso  
Ciseaux pour plâtre  
Forbici per gesso

## Verband

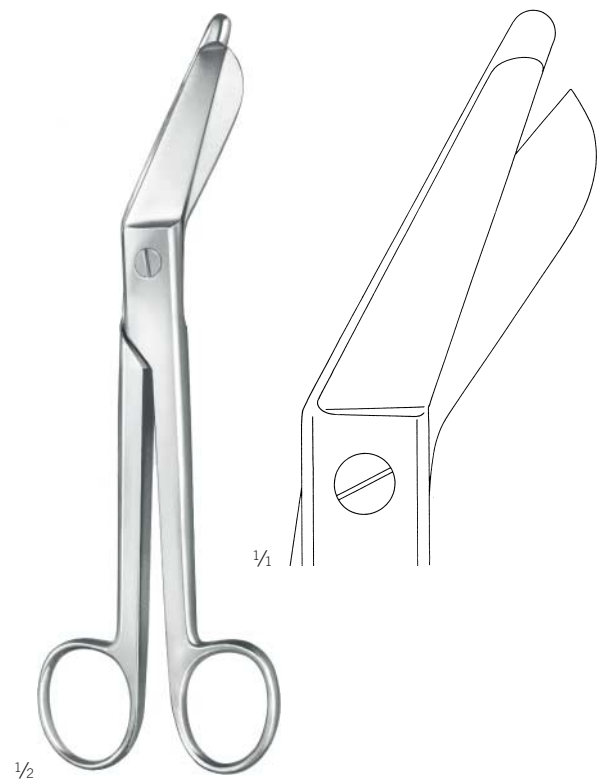
Dressings  
Vendajes  
Pansements  
Bendaggi



**Bergmann**  
21-195-23-07

23 cm / 9"

kräftiges Modell  
heavy pattern  
modelo fuerte  
modèle fort  
modello forte



**Esmarch**  
21-205-20-07

20 cm / 7 7/8"

kräftiges Modell, kurze Blätter  
heavy pattern, short blades  
modelo fuerte, hojas cortas  
modèle fort, lames courtes  
modello forte, lame curve

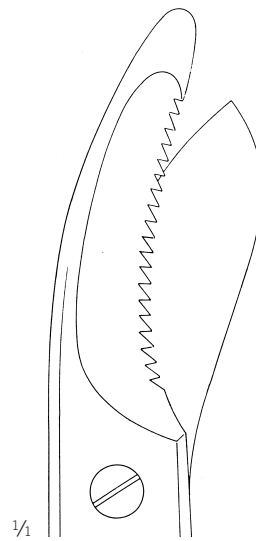
## Verbandscheren, Gipsscheren

Bandage Scissors, Plaster Shears

Tijeras para vendajes, Tijeras para yeso

Ciseaux pour pansements, Ciseaux pour plâtre

Forbici per bendaggi, Forbici per gesso



21-223-24-07

eine Schneide gezahnt  
one toothed cutting edge  
una hoja dentada  
une lame dentelée  
una lama dentata

21-223-26-07



$\frac{1}{2}$

Universal

21-209-15-01 = 15,5 cm / 6  $\frac{1}{8}$ "

21-209-18-01 = 19 cm / 7  $\frac{4}{8}$ "

schwarze Kunststoffringe, autoklavierbar  
black plastic rings, autoclavable

anillos negros, plástico, autoclavable

avec anneaux en matière plastique noire, autoclavable

anelli neri di materia plastica, sterilizzabile in autoclave



$\frac{1}{2}$

Bruns

21-223-24-07 -

21-223-26-07

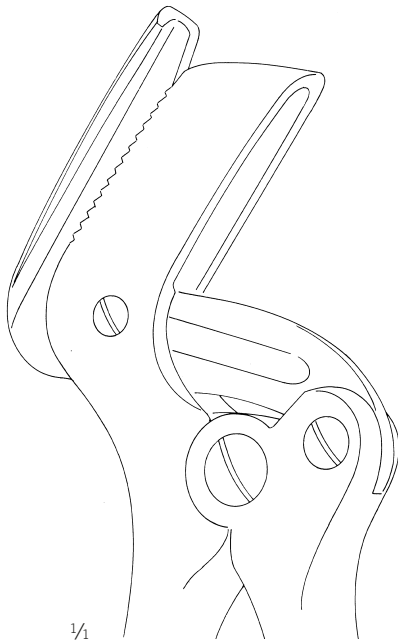
24 cm / 9  $\frac{4}{8}$ "

## Gipsscheren

Plaster Shears  
Tijeras para yeso  
Ciseaux pour plâtre  
Forbici per gesso

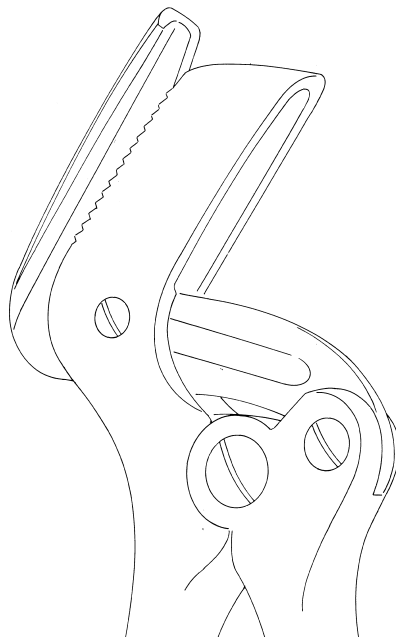
## Verband

Dressings  
Vendajes  
Pansements  
Bendaggi

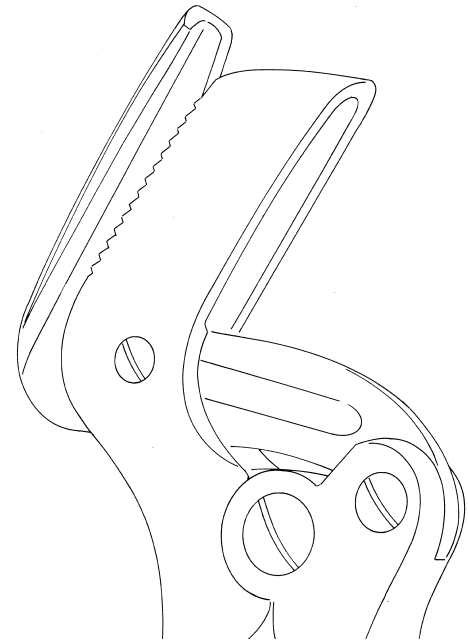


1/1

21-275-23-07  
23 cm / 9"



21-275-26-07  
27 cm / 10 5/8"



21-275-37-07  
38 cm / 15"



1/2

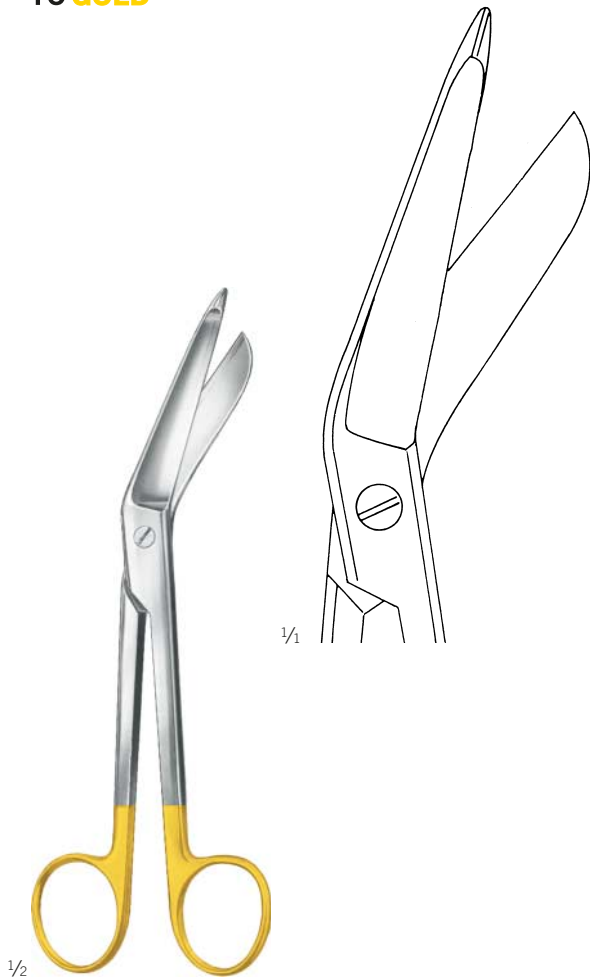
Stille-Martin  
21-275-23-07 -  
21-277-37-07

Ersatzmesser  
Spare Blade  
Hoja de recambio  
Lame de rechange  
Lama di ricambio

21-277-23-07 → 21-275-23-07  
21-277-26-07 → 21-275-26-07  
21-277-37-07 → 21-275-37-07

**Verbandscheren, Gipsscheren**  
Bandage Scissors, Plaster Shears  
Tijeras para vendajes, Tijeras para yeso  
Ciseaux pour pansements, Ciseaux pour plâtre  
Forbici per bendaggi, Forbici per gesso

**TC GOLD**



$\frac{1}{2}$

Lister  
21-291-18-07  
18 cm / 7  $\frac{1}{8}$ "



$\frac{1}{2}$

Bruns  
21-297-24-07  
23,5 cm / 9  $\frac{2}{8}$ "

## Gipsmesser

Plaster Knives  
Cuchillos para yeso  
Couteaux pour plâtre  
Coltelli per gesso

## Verband

Dressings  
Vendajes  
Pansements  
Bendaggi



1/2

Hopkins  
21-401-20-07

20 cm / 7 7/8"

mit Holzheft  
with wooden handle  
con mango de madera  
avec manche en bois  
con manico di legno



1/2

Esmarch  
21-420-18-07

18 cm / 7 1/8"



1/2

Martin  
21-431-21-07

20,5 cm / 8 1/8"

mit Holzheft  
with wooden handle  
con mango de madera  
avec manche en bois  
con manico di legno

## Gipsspreizer

Plaster Spreaders

Separadores para yeso

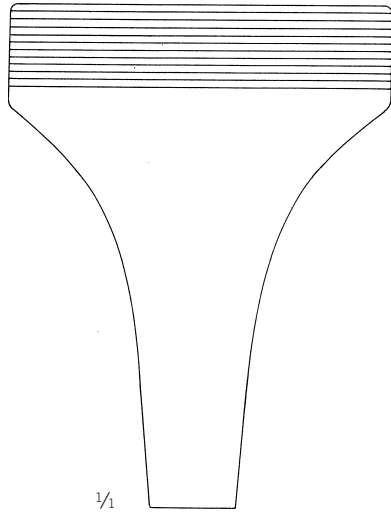
Pinces pour plâtre

Pinze per gesso



1/2

Hennig  
21-520-28-07  
28 cm / 11"

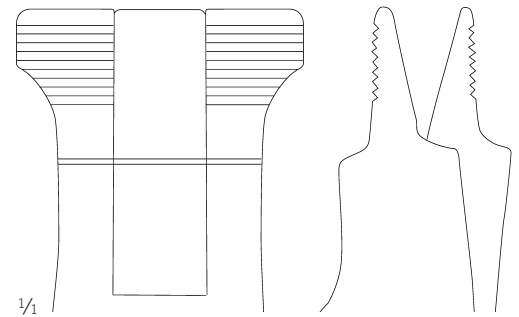


1/1



1/2

Quattro  
21-522-23-07  
23 cm / 9"



1/1

## Gipsabreißzangen

Plaster Breakers

Pinzas para romper yeso

Pinces pour rompre plâtre

Pinze per rompere gesso

## Verband

Dressings

Vendajes

Pansements

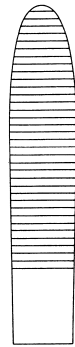
Bendaggi



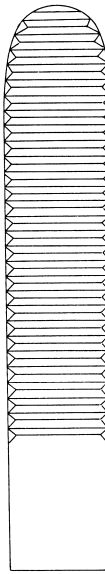
1/2

Wolff  
21-541-18-07 -  
21-545-24-07

1/4



21-541-18-07  
17,5 cm / 6 7/8"



21-545-24-07  
26,5 cm / 10 3/8"

## Oszillierende Gipssäge

Oscillating Plaster Saw

Sierra oscilante para yeso

Scie oscillante

Sega oscillata per gesso



21-551-00-04 -  
21-551-01-04

|              |              |
|--------------|--------------|
| 21-551-00-04 | 21-551-01-04 |
| 230 V        | 110 V        |
| 1,5 kg       | 1,5 kg       |

komplett mit 2 Sägeblättern und 2 Schraubenschlüsseln  
Schutzklasse II nach DIN EN 60601  
Motorschutzschalter funkentstört und schutzisoliert

complete with 2 saw blades and 2 wrenches  
safety class II acc. to DIN EN 60601  
overload protection interferences suppression  
and shockproof

completo con 2 hojas de sierra y 2 llaves de tuercas  
clase II de protección según DIN EN 60601  
protección contra sobrecarga supresión de las  
interferencias y aislamiento protector

complet avec 2 lames de scie et clé à écrou classe II  
de sécurité selon DIN EN 60601  
disjoncteur-protecteur antiparasité et double isolation

completa con 2 lame e 2 chiavi Classe II di protezione  
DIN EN 60601  
Interruttore di protezione suppressione d'interferenze  
e isolato



21-553-50-07 -  
21-553-65-07

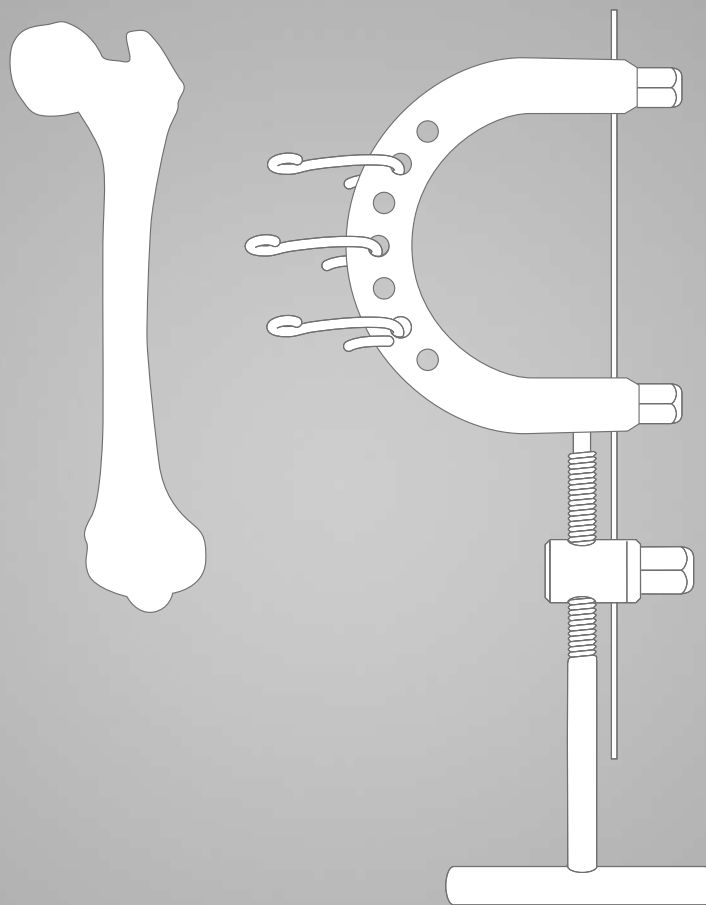
Sägeblatt rund, für Gips und Hartverbände  
Saw Blade round, for plaster of paris and synthetic casts  
Hoja de sierra rond, pour plâtre régulier et synthétique  
Lame de scie rond, pour plâtre régulier et synthétique  
Lama da sega rotonda, per ingessatura e bendaggi duri

|              |           |
|--------------|-----------|
| 21-553-50-07 | = 50 mm Ø |
| 21-553-65-07 | = 65 mm Ø |



Knochenchirurgie  
Bone Surgery  
Cirugía ósea  
Chirurgie osseuse  
Chirurgia ossea

# 22



## Spezial-Produkte

Special Products

Productos especiales

Produits spéciaux

Prodotti speciali

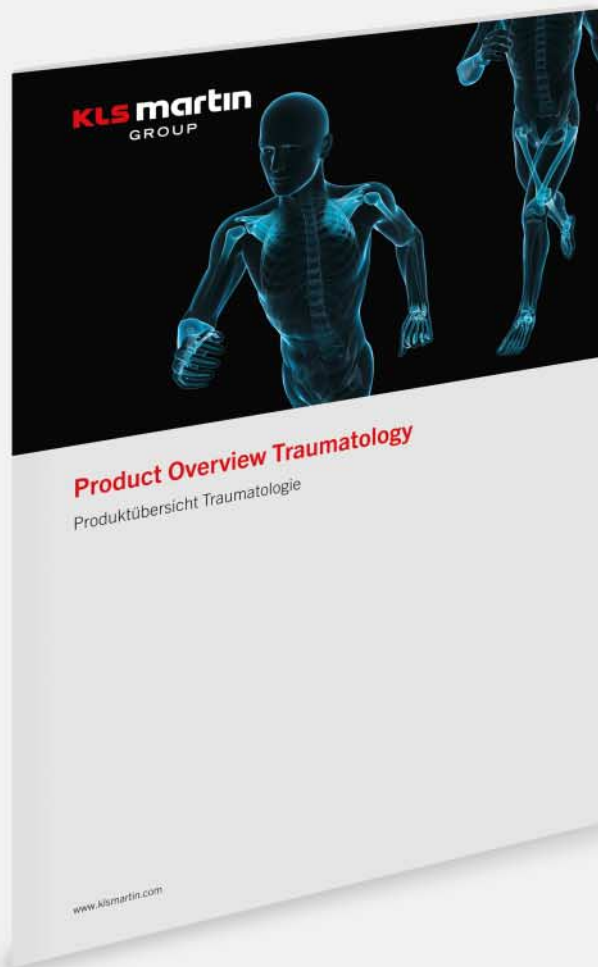
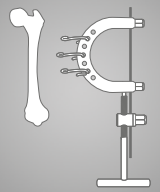
Unser Katalog „Produktübersicht Traumatologie“ enthält die gesamte Palette der KLS-Martin-Instrumente für die Knochenchirurgie

Our catalog “Product Overview Traumatology” contains the full range of KLS-Martin implants and instruments for bone surgery.

Nuestro catálogo “Product Overview Traumatology” incluye la gama completa de los implantes e instrumentos de KLS-Martin para la cirugía ósea.

Notre catalogue «Product Overview Traumatology» contient l’ensemble de la palette des implants et instruments KLS Martin pour la chirurgie osseuse

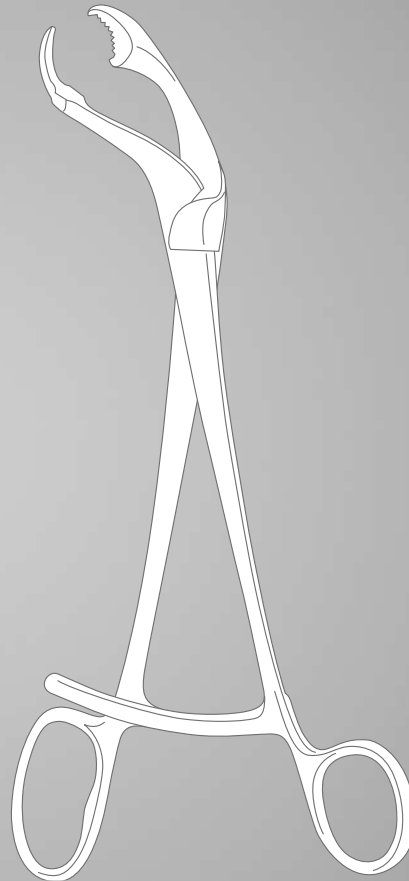
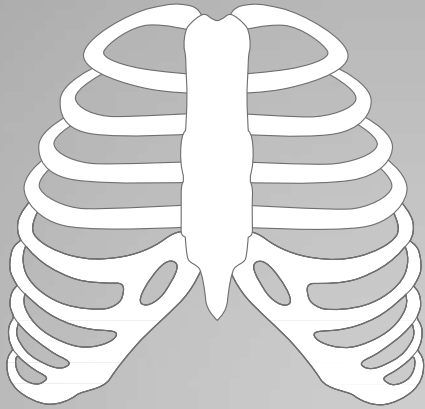
Il nostro catalogo “Product Overview Traumatology” contiene la gamma completa degli impianti e degli strumenti di KLS Martin per la chirurgia ossea





Knochenchirurgie  
Bone Surgery  
Cirugía ósea  
Chirurgie osseuse  
Chirurgia ossea

# 23



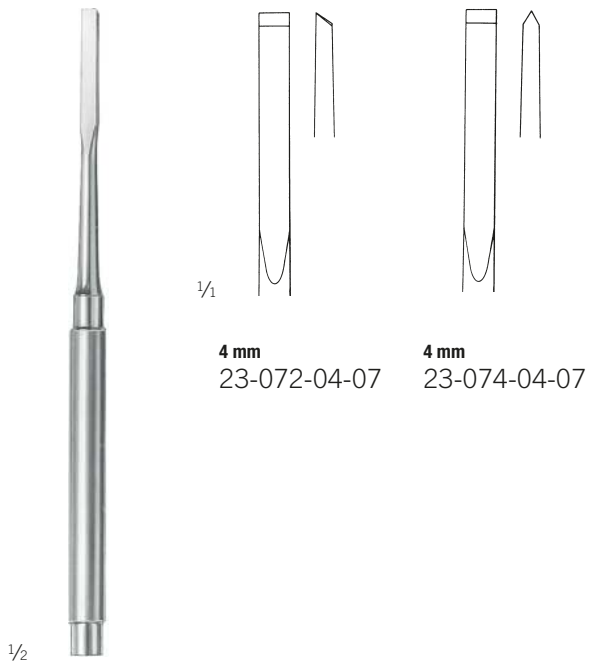
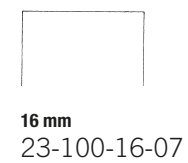
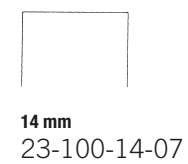
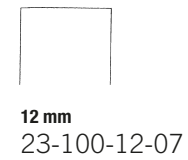
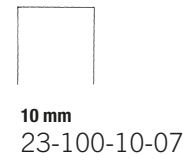
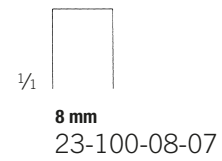
# Knochenmeißel, Osteotome

Bone Chisels, Osteotomes

Cinceles, Osteótomos

Ciseaux-burins, Ostéotomes

ScalPELLi, Osteotomi



23-072-04-07 -  
23-074-04-07  
17 cm / 6 5/8"

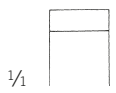
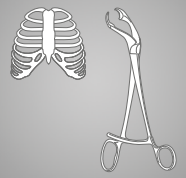
23-100-08-07 -  
23-100-16-07  
13,5 cm / 5 3/8"

## Flachmeißel, Hohlmeißel

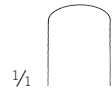
Chisels, Gouges  
Cinceles, Gubias  
Ciseaux-burins, Gouges  
Scalpelli, Sgorbie

## Knochenchirurgie

Bone Surgery  
Cirugía ósea  
Chirurgie osseuse  
Chirurgia ossea



8 mm  
23-101-08-07



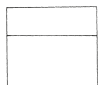
8 mm  
23-102-08-07



10 mm  
23-101-10-07



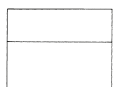
10 mm  
23-102-10-07



12 mm  
23-101-12-07



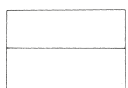
12 mm  
23-102-12-07



14 mm  
23-101-14-07



14 mm  
23-102-14-07



16 mm  
23-101-16-07



16 mm  
23-102-16-07



23-101-08-07 -  
23-101-16-07  
13,5 cm / 5 3/8"

23-102-08-07 -  
23-102-16-07  
13,5 cm / 5 3/8"

# Flachmeißel, Hohlmeißel

Chisels  
Cinceles  
Ciseaux-burins  
Scalpelli



**2 mm**  
23-105-02-07  
13,5 cm / 5 3/8"



**2 mm**  
23-106-02-07  
17 cm / 6 5/8"



**2 mm**  
23-109-02-07  
13,5 cm / 5 3/8"



**2 mm**  
23-110-02-07  
16,5 cm / 6 4/8"



**3 mm**  
23-105-03-07  
13,5 cm / 5 3/8"



**3 mm**  
23-106-03-07  
17 cm / 6 5/8"



**3 mm**  
23-109-03-07  
13,5 cm / 5 3/8"



**3 mm**  
23-110-03-07  
16,5 cm / 6 4/8"



**4 mm**  
23-105-04-07  
13,5 cm / 5 3/8"



**4 mm**  
23-106-04-07  
17 cm / 6 5/8"



**4 mm**  
23-109-04-07  
13,5 cm / 5 3/8"



**4 mm**  
23-110-04-07  
16,5 cm / 6 4/8"



**5 mm**  
23-105-05-07  
13,5 cm / 5 3/8"



**5 mm**  
23-106-05-07  
17 cm / 6 5/8"



**5 mm**  
23-109-05-07  
13,5 cm / 5 3/8"



**5 mm**  
23-110-05-07  
16,5 cm / 6 4/8"



**6 mm**  
23-105-06-07  
13,5 cm / 5 3/8"



**6 mm**  
23-106-06-07  
17 cm / 6 5/8"



**6 mm**  
23-109-06-07  
13,5 cm / 5 3/8"



**6 mm**  
23-110-06-07  
16,5 cm / 6 4/8"



1/2

Partsch  
23-105-02-07 -  
23-106-06-07



1/2

Partsch  
23-109-02-07 -  
23-110-06-07

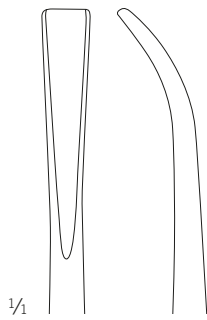
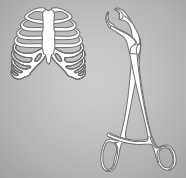


# Flachmeißel, Hohlmeißel

Chisels  
Cinceles  
Ciseaux-burins  
Scalpelli

# Knochenchirurgie

Bone Surgery  
Cirugía ósea  
Chirurgie osseuse  
Chirurgia ossea



5,5 mm  
23-112-05-04



9 mm  
23-112-09-04

1/2

Zielke  
23-112-05-04 -  
23-112-09-04  
23 cm / 9"



4 mm  
23-118-04-07



6 mm  
23-118-06-07



8 mm  
23-118-08-07



10 mm  
23-118-10-07



12 mm  
23-118-12-07



14 mm  
23-118-14-07

1/2

Alexander  
23-118-04-07 -  
23-118-14-07  
17,5 cm / 6 7/8"  
massiv  
solid  
macizo  
solide  
pieno



4 mm  
23-119-04-07



6 mm  
23-119-06-07



8 mm  
23-119-08-07



10 mm  
23-119-10-07



12 mm  
23-119-12-07



14 mm  
23-119-14-07

1/2

Alexander  
23-119-04-07 -  
23-119-14-07  
17,5 cm / 6 7/8"  
massiv  
solid  
macizo  
solide  
pieno

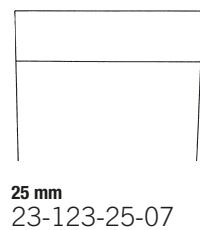
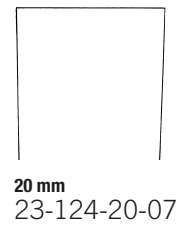
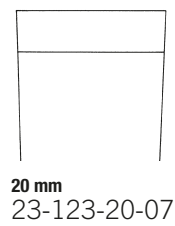
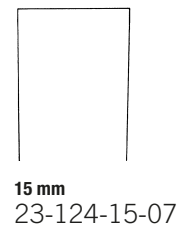
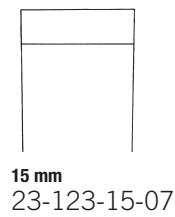
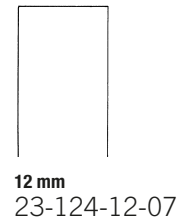
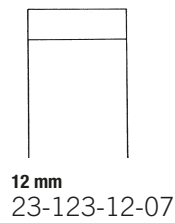
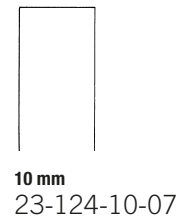
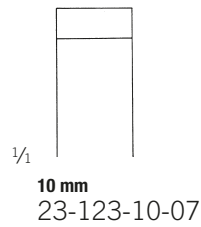
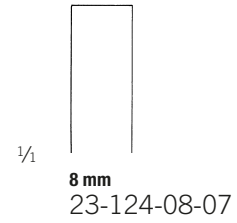
# Flachmeißel, Osteotome

Chisels, Osteotomes

Cinceles, Osteótomos

Ciseaux-burins, Ostéotomes

Scalpelli, Osteotomi



Stille  
23-123-10-07 -  
23-123-25-07  
20,5 cm / 8 1/8"

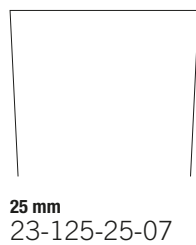
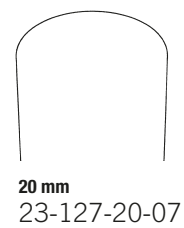
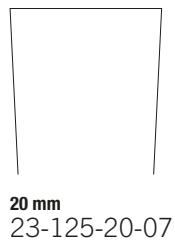
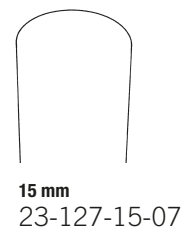
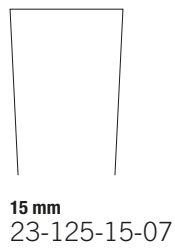
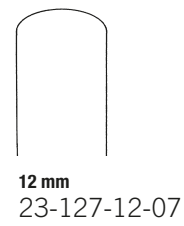
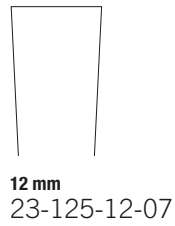
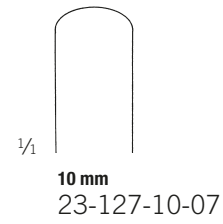
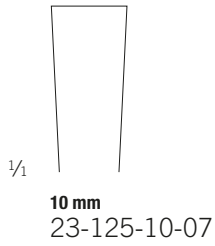
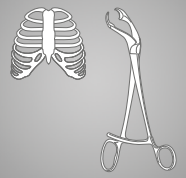
Stille  
23-124-08-07 -  
23-124-25-07  
20,5 cm / 8 1/8"

# Osteotome, Hohlmeißel

Osteotomes, Gouges  
Cinceles, Gubias  
Osteótomos, Gouges  
Osteotomi, Sgorbie

# Knochenchirurgie

Bone Surgery  
Cirugía ósea  
Chirurgie osseuse  
Chirurgia ossea



1/2  
Stille  
23-125-10-07 -  
23-125-25-07  
20,5 cm / 8 1/8"  
fein  
delicate  
fino  
fin  
fino

1/2  
Stille  
23-127-10-07 -  
23-127-25-07  
20,5 cm / 8 1/8"

## Meißelklingen, Meißelgriff

Chisel Blades, Chisel Handle

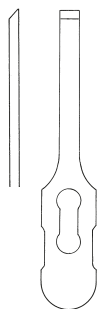
Hojas de cincel, Mango para hojas de cincel

Lames-gouges, Manche pour ciseaux-burins

Lame per sgorbie, Manico per scalpello

Sic

Meißelklingen, auswechselbar  
Chisel blades, interchangeable  
Hojas de cincel, intercambiables  
Lames ciseaux-burin, interchangeable  
Lame intercambiabili



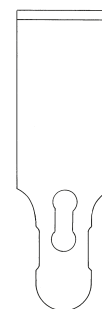
**5 mm**  
23-130-05-07  
8 cm / 3 1/8"



**10 mm**  
23-130-10-07  
8 cm / 3 1/8"



**16 mm**  
23-130-16-07  
8 cm / 3 1/8"

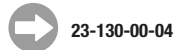


**25 mm**  
23-130-25-07  
8 cm / 3 1/8"

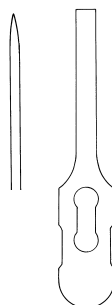


23-130-90-98

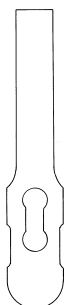
Halteschraube  
Spare Screw  
Tornillo de repuesto  
Vis de rechange  
Vite di ricambio



Osteotomklingen, auswechselbar  
Osteotome blades, interchangeable  
Hojas de osteótomo, intercambiables  
Lame per osteotomia, intercambiabili  
Lame per osteotomia, intercambiabili



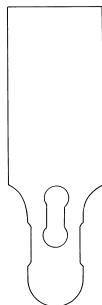
**5 mm**  
23-130-55-07  
8 cm / 3 1/8"



**10 mm**  
23-130-60-07  
8 cm / 3 1/8"



**16 mm**  
23-130-66-07  
8 cm / 3 1/8"



**25 mm**  
23-130-85-07  
8 cm / 3 1/8"



23-130-99-07

Spannschlüssel  
Key  
Llave  
Clé  
Chiave



1/2

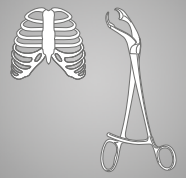
23-130-00-04  
18,5 cm / 7 3/8"

## Spongiosaentnahmemeißel

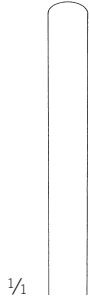
Spongiosa Gouges  
Cinceles de esponjosa  
Ciseaux-burinx pour spongiosa  
Scalpelli per spongiosa

## Knochenchirurgie

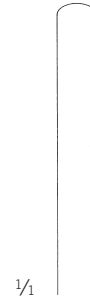
Bone Surgery  
Cirugía ósea  
Chirurgie osseuse  
Chirurgia ossea



Sic



5 mm  
23-131-05-04



5 mm  
23-131-55-04



10 mm  
23-131-10-04



10 mm  
23-131-60-04



15 mm  
23-131-15-04



15 mm  
23-131-65-04

1/2

Lexer  
23-131-05-04 -  
23-131-15-04  
24,5 cm / 9 5/8"

1/2

Lexer  
23-131-55-04 -  
23-131-65-04  
24,5 cm / 9 5/8"

## Osteotome, Hohlmeißel

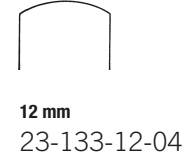
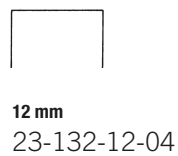
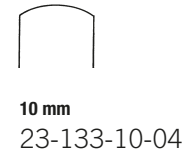
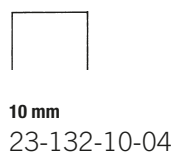
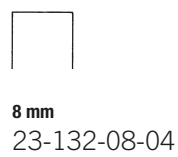
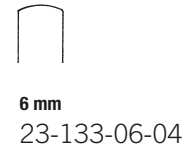
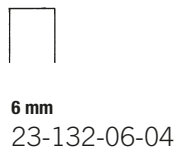
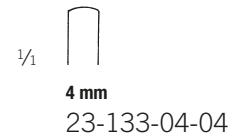
Osteotomes, Gouges

Osteótomos, Gubias

Ostéotomes, Gouges

Osteotomi, Sgorbie

Sic



$\frac{1}{2}$



Lexer-Mini  
23-132-04-04 -  
23-132-12-04  
18 cm / 7  $\frac{1}{8}$ "

$\frac{1}{2}$



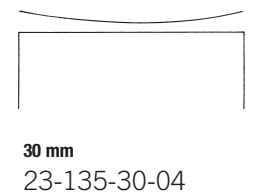
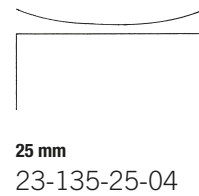
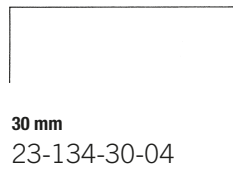
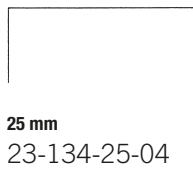
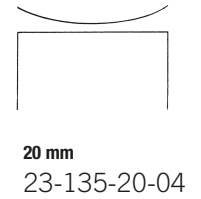
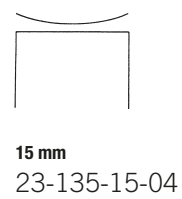
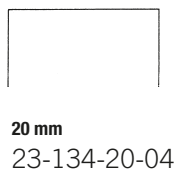
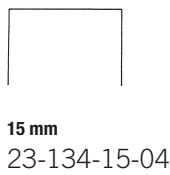
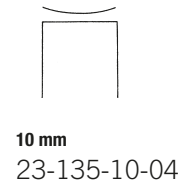
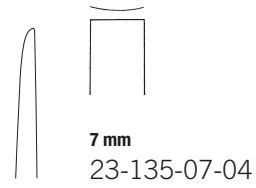
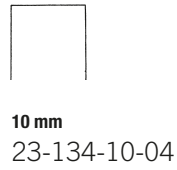
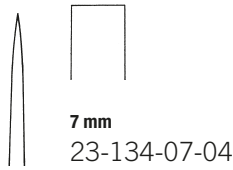
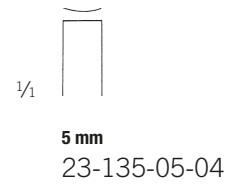
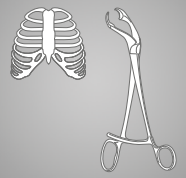
Lexer-Mini  
23-133-04-04 -  
23-133-12-04  
18 cm / 7  $\frac{1}{8}$ "

# Osteotome, Hohlmeißel

Osteotomes, Gouges  
 Osteótomos, Gubias  
 Ostéotomes, Gouges  
 Osteotomi, Sgorbie

# Knochenchirurgie

Bone Surgery  
 Cirugía ósea  
 Chirurgie osseuse  
 Chirurgia ossea



Lexer  
 23-134-05-04 -  
 23-134-30-04  
 22 cm / 8 5/8"

Lexer  
 23-135-05-04 -  
 23-135-30-04  
 22 cm / 8 5/8"

# Osteotome

Osteotomes

Osteótomos

Ostéotomes

Osteotomi



**2 mm**

23-136-02-07



**3 mm**

23-136-03-07



**3 mm**

23-136-53-07



**4 mm**

23-136-54-07



**4 mm**

23-136-04-07



**6 mm**

23-136-06-07



**6 mm**

23-136-56-07



**8 mm**

23-136-58-07



**8 mm**

23-136-08-07



**10 mm**

23-136-10-07



**10 mm**

23-136-60-07



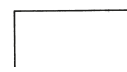
**12 mm**

23-136-62-07



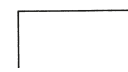
**12 mm**

23-136-12-07



**15 mm**

23-136-15-07



**15 mm**

23-136-65-07



Lambotte-Mini  
23-136-02-07 -  
23-136-15-07  
12,5 cm / 4  $\frac{7}{8}$ "



Lambotte-Mini  
23-136-53-07 -  
23-136-65-07  
17 cm / 6  $\frac{6}{8}$ "

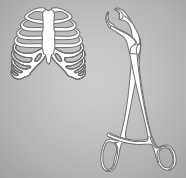








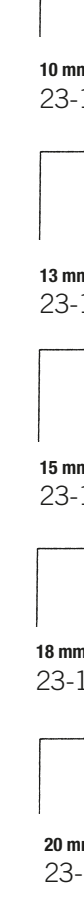


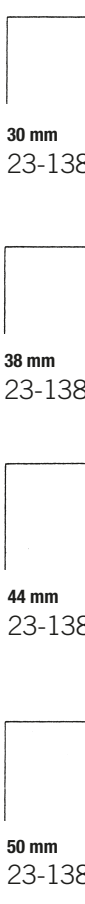
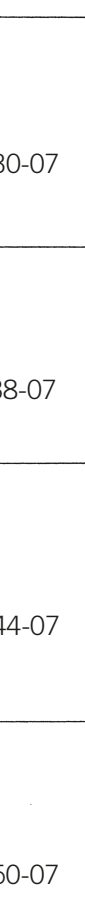
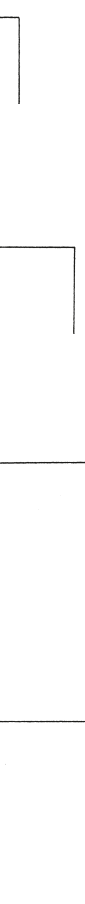
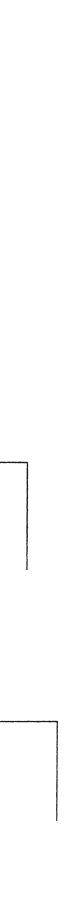
# Osteotome

Osteotomes  
Osteótomos  
Ostéotomes  
Osteotomi

# Knochenchirurgie

Bone Surgery  
Cirugía ósea  
Chirurgie osseuse  
Chirurgia ossea



|   |   |   |   |   |   |   |   |  |   |   |   |   |                               |                               |
|---|---|---|---|---|---|---|---|--|---|---|---|---|-------------------------------|-------------------------------|
|  |  |  |  |  |  |  |  |  |  |  |  |  |                               |                               |
| <p>1/2</p>  | <p>1/2</p>  | <p>1/4</p>  | <p>1/4</p>  | <p>1/4</p>  | <p>1/4</p>  | <p>1/4</p>  | <p>1/4</p>  | <p>1/2</p>   | <p>1/2</p>  | <p>1/2</p>  | <p>1/2</p>  | <p>1/2</p>  |                               |                               |
| <p>Lambotte<br/>23-138-04-07 -<br/>23-138-06-07<br/>24 cm / 9 4/8"</p>              | <p>Lambotte<br/>23-138-08-07 -<br/>23-138-50-07<br/>24 cm / 9 4/8"</p>              | <p>4 mm<br/>23-138-04-07</p>  | <p>6 mm<br/>23-138-06-07</p>  | <p>8 mm<br/>23-138-08-07</p>  | <p>10 mm<br/>23-138-10-07</p>   | <p>13 mm<br/>23-138-13-07</p>   | <p>15 mm<br/>23-138-15-07</p>   | <p>18 mm<br/>23-138-18-07</p>  | <p>20 mm<br/>23-138-20-07</p>   | <p>25 mm<br/>23-138-25-07</p>   | <p>30 mm<br/>23-138-30-07</p>   | <p>38 mm<br/>23-138-38-07</p>   | <p>44 mm<br/>23-138-44-07</p> | <p>50 mm<br/>23-138-50-07</p> |

# Osteotome


Osteotomes


Osteótomos


Ostéotomes

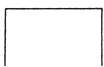
Osteotomi

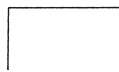
$\frac{1}{4}$    
**4 mm**  
23-139-04-07

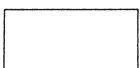
  
**6 mm**  
23-139-06-07

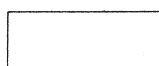
  
**8 mm**  
23-139-08-07

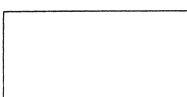
  
**10 mm**  
23-139-10-07

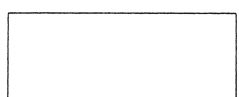
  
**13 mm**  
23-139-13-07

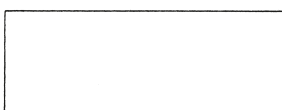
  
**15 mm**  
23-139-15-07

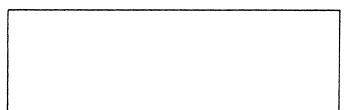
  
**18 mm**  
23-139-18-07

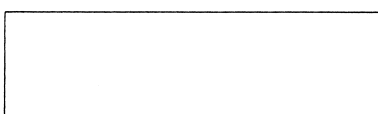
  
**20 mm**  
23-139-20-07

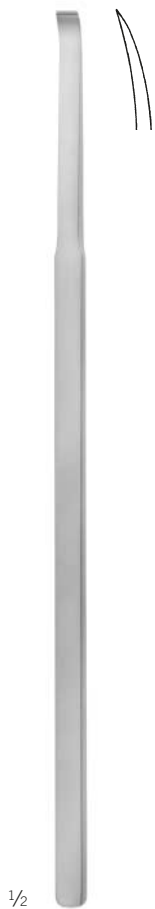
  
**25 mm**  
23-139-25-07

  
**30 mm**  
23-139-30-07

  
**38 mm**  
23-139-38-07

  
**44 mm**  
23-139-44-07

  
**50 mm**  
23-139-50-07



Lambotte  
23-139-04-07 -  
23-139-06-07  
24 cm / 9 <sup>4</sup>/<sub>8</sub>"

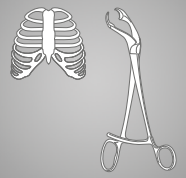
Lambotte  
23-139-08-07 -  
23-139-50-07  
24 cm / 9 <sup>4</sup>/<sub>8</sub>"

# Osteotome

Osteotomes  
Osteótomos  
Ostéotomes  
Osteotomi

# Knochenchirurgie

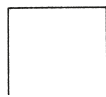
Bone Surgery  
Cirugía ósea  
Chirurgie osseuse  
Chirurgia ossea



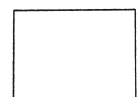
**6 mm**  
23-154-06-07



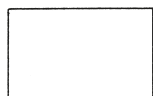
**9 mm**  
23-154-09-07



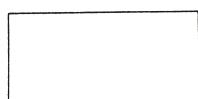
**13 mm**  
23-154-13-07



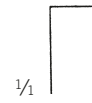
**16 mm**  
23-154-16-07



**19 mm**  
23-154-19-07



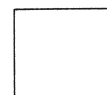
**25 mm**  
23-154-25-07



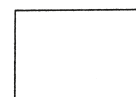
**6 mm**  
23-155-06-07



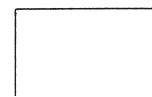
**9 mm**  
23-155-09-07



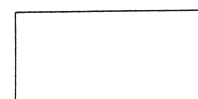
**13 mm**  
23-155-13-07



**16 mm**  
23-155-16-07



**19 mm**  
23-155-19-07



**25 mm**  
23-155-25-07



Smith-Petersen  
23-154-06-07 -  
23-154-25-07  
20,5 cm / 8 1/8"



Smith-Petersen  
23-155-06-07 -  
23-155-25-07  
20,5 cm / 8 1/8"

# Hohlmeißel

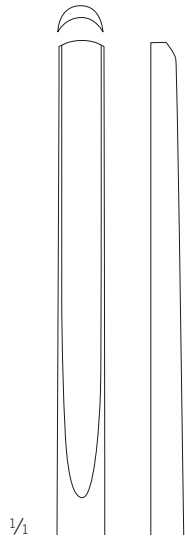
Gouges

Gubias

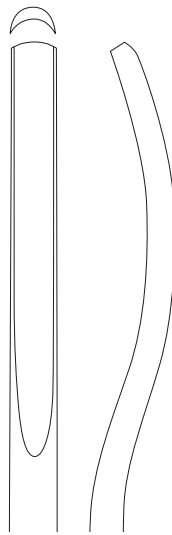
Gouges

Sgorbie

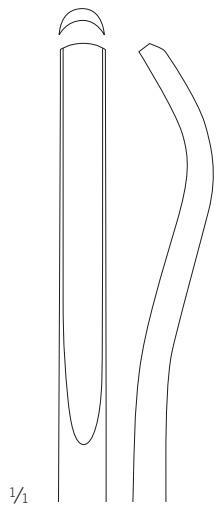
Sic



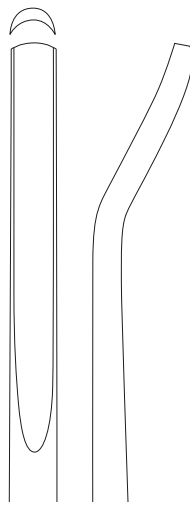
6 mm  
23-160-01-04



6 mm  
23-160-02-04



6 mm  
23-160-03-04



6 mm  
23-160-04-04



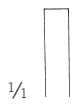
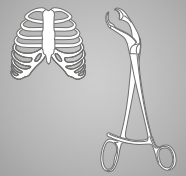
Cobb  
23-160-01-04 -  
23-160-04-04  
28 cm / 11"

## Osteotome, Flachmeißel

Osteotomes, Chisels  
 Osteótomos, Cinceles  
 Ostéotomes, Ciseaux-burins  
 Osteotomi, Scalpelli

## Knochenchirurgie

Bone Surgery  
 Cirugía ósea  
 Chirurgie osseuse  
 Chirurgia ossea



**3 mm**  
 23-162-03-07



**6 mm**  
 23-170-06-07



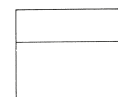
**6 mm**  
 23-172-06-07



**5 mm**  
 23-162-05-07



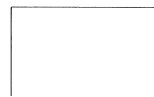
**13 mm**  
 23-170-13-07



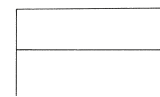
**13 mm**  
 23-172-13-07



**6 mm**  
 23-162-06-07



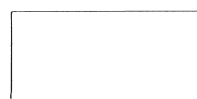
**19 mm**  
 23-170-19-07



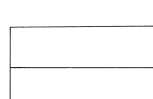
**19 mm**  
 23-172-19-07



**8 mm**  
 23-162-08-07



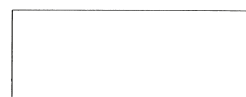
**25 mm**  
 23-170-25-07



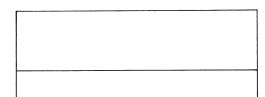
**25 mm**  
 23-172-25-07



**9 mm**  
 23-162-09-07



**32 mm**  
 23-170-32-07



**32 mm**  
 23-172-32-07

1/2

Hoke  
 23-162-03-07 -  
 23-162-09-07  
 17 cm / 6 5/8"

1/2

Hibbs  
 23-170-06-07 -  
 23-170-32-07  
 24,5 cm / 9 5/8"

1/2

Hibbs  
 23-172-06-07 -  
 23-172-32-07  
 24,5 cm / 9 5/8"

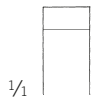
## Osteotome, Hohlmeißel

Osteotomes, Gouges

Osteótomos, Gubias

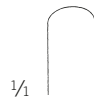
Ostéotomes, Gouges

Osteotomi, Sgorbie



6 mm

23-173-06-07



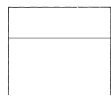
6 mm

23-176-06-07



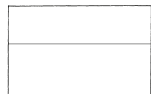
6 mm

23-177-06-07



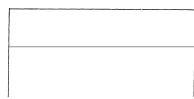
13 mm

23-173-13-07



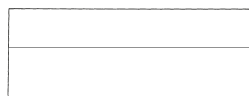
19 mm

23-173-19-07



25 mm

23-173-25-07

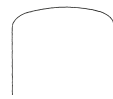


32 mm

23-173-32-07

1/2

Hibbs  
23-173-06-07 -  
23-173-32-07  
24,5 cm / 9 5/8"



13 mm

23-176-13-07



19 mm

23-176-19-07



25 mm

23-176-25-07

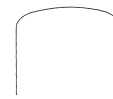


32 mm

23-176-32-07

1/2

Hibbs  
23-176-06-07 -  
23-176-32-07  
24,5 cm / 9 5/8"



13 mm

23-177-13-07



19 mm

23-177-19-07



25 mm

23-177-25-07



32 mm

23-177-32-07

1/2

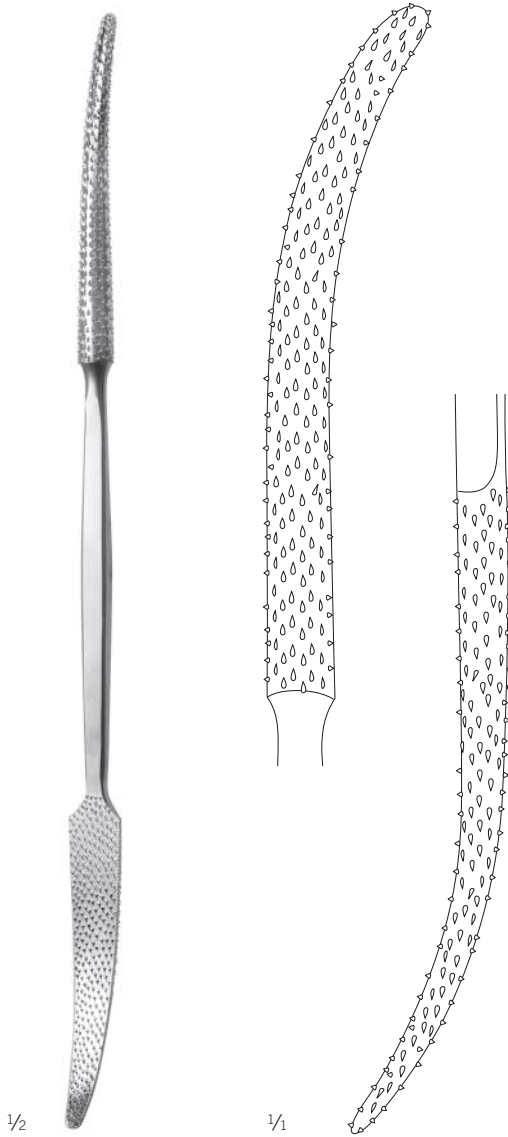
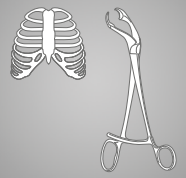
Hibbs  
23-177-06-07 -  
23-177-32-07  
24,5 cm / 9 5/8"

## Knochenraspeln

Bone Rasps  
Escofinas para hueso  
Râpes pour os  
Raspe per ossa

## Knochenchirurgie

Bone Surgery  
Cirugía ósea  
Chirurgie osseuse  
Chirurgia ossea



1/2

1/1

Putti  
23-181-30-07  
30 cm / 11 5/8"  
rund/halbrund  
round / semi round  
redonda / semi-redonda  
ronde / semi-ronde  
rotondo / semi-rotondo

# Stößel

Tamper  
Punzón  
Pilon  
Pestone

1/4 

**Ø 3 mm**  
23-197-03-04



**Ø 5 mm**  
23-197-05-04



**Ø 8 mm**  
23-197-08-04



1/2

Caspar  
23-197-03-04 -  
23-197-08-04  
22 cm / 8 5/8"



1/4 

**Ø 2 mm**  
23-198-02-07



**Ø 4 mm**  
23-198-04-07



**Ø 6 mm**  
23-198-06-07



**Ø 10 mm**  
23-198-10-07



1/2

23-198-02-07 -  
23-198-10-07  
15,5 cm / 6 1/8"



**Ø 3 mm**  
23-198-03-07



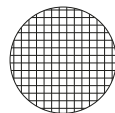
**Ø 5 mm**  
23-198-05-07



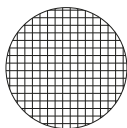
**Ø 8 mm**  
23-198-08-07

1/4 

**Ø 12 mm**  
23-199-12-04



**Ø 14 mm**  
23-199-14-04



**Ø 16 mm**  
23-199-16-04



1/2

23-199-12-04 -  
23-199-16-04  
20 cm / 8"



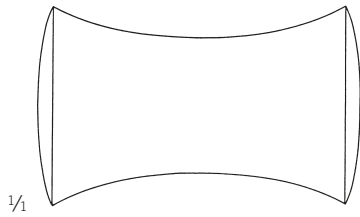
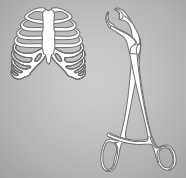


# Hämmer

Mallets  
Martillos  
Maillets  
Martelli

# Knochenchirurgie

Bone Surgery  
Cirugía ósea  
Chirurgie osseuse  
Chirurgia ossea

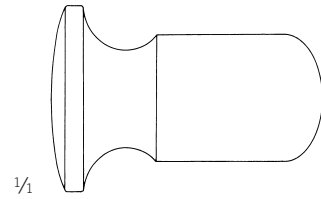


1/1

23-200-01-07  
24 cm / 9 4/8"

|         |        |
|---------|--------|
| Gewicht | Kopf   |
| weight  | head   |
| peso    | cabeza |
| poids   | tête   |
| peso    | testa  |

**275 g      Ø 26 mm**

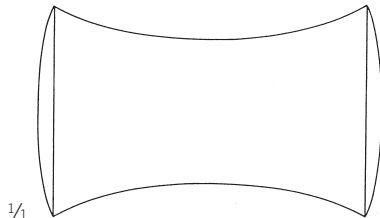


1/1

23-204-01-07  
20,5 cm / 8 1/8"

|         |        |
|---------|--------|
| Gewicht | Kopf   |
| weight  | head   |
| peso    | cabeza |
| poids   | tête   |
| peso    | testa  |

**120 g      Ø 25 mm**

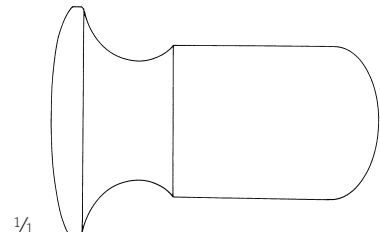


1/1

23-200-02-07  
24 cm / 9 4/8"

|         |        |
|---------|--------|
| Gewicht | Kopf   |
| weight  | head   |
| peso    | cabeza |
| poids   | tête   |
| peso    | testa  |

**320 g      Ø 28 mm**



1/1

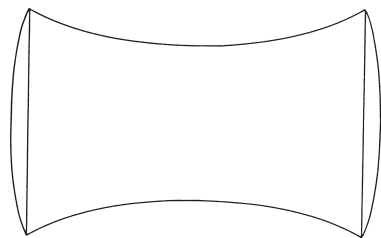
23-204-02-07  
21 cm / 8 2/8"

|         |        |
|---------|--------|
| Gewicht | Kopf   |
| weight  | head   |
| peso    | cabeza |
| poids   | tête   |
| peso    | testa  |

**170 g      Ø 30 mm**



1/2



1/1

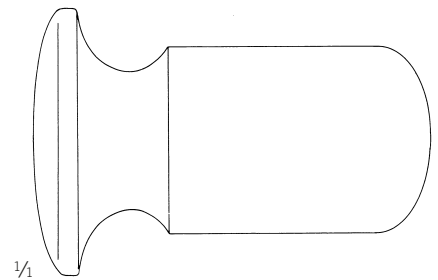
23-200-03-07  
24 cm / 9 4/8"

|         |        |
|---------|--------|
| Gewicht | Kopf   |
| weight  | head   |
| peso    | cabeza |
| poids   | tête   |
| peso    | testa  |

**340 g      Ø 30 mm**



1/2



1/1

23-204-03-07  
21,5 cm / 8 4/8"

|         |        |
|---------|--------|
| Gewicht | Kopf   |
| weight  | head   |
| peso    | cabeza |
| poids   | tête   |
| peso    | testa  |

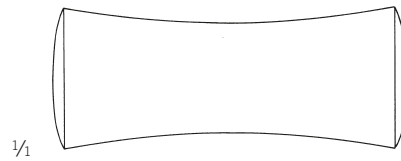
**260 g      Ø 35 mm**

Williger  
23-200-01-07 -  
23-200-03-07

Doyen  
23-204-01-07 -  
23-204-03-07

# Hämmer

Mallets  
Martillos  
Maillets  
Martelli



1/1

23-214-01-07

Kopf  
head  
cabeza  
tête  
testa

Ø 30 mm

Kopf  
head  
cabeza  
tête  
testa

Ø 19 mm

Gewicht  
weight  
peso  
poids  
peso

230 g

Kopf  
head  
cabeza  
tête  
testa

Ø 30 mm



1/2

Collin  
23-208-20-07  
20 cm / 7 7/8"

Gesamtgewicht  
Total weight  
Peso total  
Poids total  
Peso totale

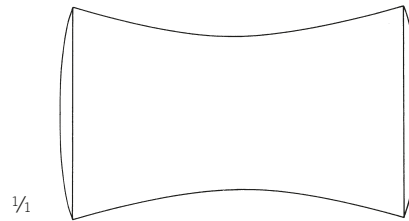
220 g



1/2

Lucae  
23-214-01-07 -  
23-214-02-07

19,5 cm / 7 5/8"



1/1

23-214-02-07

Kopf  
head  
cabeza  
tête  
testa

Ø 25 mm

Gewicht  
weight  
peso  
poids  
peso

260 g



1/2

Cottle  
23-215-19-07  
19 cm / 7 4/8"

plan/konvex  
plane / convex  
plano / convexo  
plan / convexe  
plano / convesso

Gesamtgewicht  
Total weight  
Peso total  
Poids total  
Peso totale

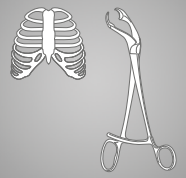
300 g

## Hämmer

Mallets  
Martillos  
Maillets  
Martelli

## Knochenchirurgie

Bone Surgery  
Cirugía ósea  
Chirurgie osseuse  
Chirurgia ossea



Ø Kopf      Kopfgewicht  
Ø Head      Head weight  
Ø Cabeza    Peso de la cabeza  
Ø Tête      Poids de tête  
Ø Testa      Peso della testa  
**34 mm      410 g**

Kopf  
head  
cabeza  
tête  
testa

**Ø 20 mm**



1/2

Williger  
23-216-01-07  
16,5 cm / 6 4/8"

Gesamtgewicht  
Total weight  
Peso total  
Poids total  
Peso totale

**140 g**



1/2

23-218-22-04  
25 cm / 9 7/8"



Gesamtgewicht  
Total weight  
Peso total  
Poids total  
Peso totale

**650 g**

Ø Kopf  
Ø Head  
Ø Cabeza  
Ø Tête  
Ø Testa  
**27 mm**



1/2

23-221-00-04  
Ersatzbacken (Paar)  
Spare Facings (pair)  
Tapas de repuesto (par)  
Plaques de rechange (paire)  
Placche di ricambio (paio)



**23-220-17-02**

Mead  
23-220-17-02  
19 cm / 7 4/8"

mit austauschbaren Kunststoffbacken  
with interchangeable plastic disks  
con tapas intercambiables  
avec plaques interchangeables  
con placche intercambiabili

Gesamtgewicht  
Total weight  
Peso total  
Poids total  
Peso totale

**330 g**

# Hämmer

Mallets  
Martillos  
Maillets  
Martelli

|              |                   |
|--------------|-------------------|
| Ø Kopf       | Kopfgewicht       |
| Ø Head       | Head weight       |
| Ø Cabeza     | Peso de la cabeza |
| Ø Tête       | Poids de tête     |
| Ø Testa      | Peso della testa  |
| <b>34 mm</b> | <b>460 g</b>      |

|                   |                   |
|-------------------|-------------------|
| Ø Kopf            | Kopfgewicht       |
| Ø Head            | Head weight       |
| Ø Cabeza          | Peso de la cabeza |
| Ø Tête            | Poids de tête     |
| Ø Testa           | Peso della testa  |
| <b>34 / 49 mm</b> | <b>650 g</b>      |

Kopf  
head  
cabeza  
tête  
testa

**Ø 27 mm**



1/2

Partsch  
23-224-18-07

19 cm / 7 4/8"

mit Hohlheft  
with hollow handle  
con mango hueco  
avec manche creux  
con manico vuoto

Gesamtgewicht  
Total weight  
Peso total  
Poids total  
Peso totale

**175 g**



23-256-00-04

Ersatzbacke  
Spare facing  
Tapa de repuesto  
Placque de rechange  
Placche di ricambio



**23-240-29-04,  
23-254-22-04**



1/2

23-240-29-04

25 cm / 9 7/8"

plan (Kunststoff), konvex (Stahl),  
plane (nylon), convexe (steel),  
plano (nilón), convexo (acero),  
plan (nylon), convexe (acier),  
plano (nilon), convesso (acciaio),



Gesamtgewicht  
Total weight  
Peso total  
Poids total  
Peso totale

**700 g**



1/2

23-242-24-04

26 cm / 10 2/8"



Gesamtgewicht  
Total weight  
Peso total  
Poids total  
Peso totale

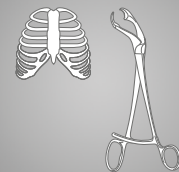
**890 g**

## Hämmer

Mallets  
Martillos  
Maillets  
Martelli

## Knochenchirurgie

Bone Surgery  
Cirugía ósea  
Chirurgie osseuse  
Chirurgia ossea



Sic

Ø Kopf  
Ø Head  
Ø Cabeza  
Ø Tête  
Ø Testa

Kopfgewicht  
Head weight  
Peso de la cabeza  
Poids de tête  
Peso della testa

**34 mm**

**470 g**

Ø Kopf  
Ø Head  
Ø Cabeza  
Ø Tête  
Ø Testa

Kopfgewicht  
Head weight  
Peso de la cabeza  
Poids de tête  
Peso della testa

**34 mm**

**400 g**

Ø Kopf  
Ø Head  
Ø Cabeza  
Ø Tête  
Ø Testa

Kopfgewicht  
Head weight  
Peso de la cabeza  
Poids de tête  
Peso della testa

**34 mm**

**270 g**



1/2

23-244-24-04

25 cm / 9 7/8"

Gesamtgewicht  
Total weight  
Peso total  
Poids total  
Peso totale

**710 g**



23-256-00-04

Ersatzbacke  
Spare facing  
Tapa de repuesto  
Placque de rechange  
Placche di ricambio



23-240-29-04,  
23-253-22-04,  
23-254-22-04



1/2

23-253-22-04

25 cm / 9 7/8"

plan (Kunststoff), konvex (Stahl),  
plane (nylon), convexe (steel),  
plano (nilón), convexo (acero),  
plan (nylon), convexe (acier),  
plano (nilon), convesso (acciaio),

Gesamtgewicht  
Total weight  
Peso total  
Poids total  
Peso totale

**640 g**



1/2

23-254-22-04

25 cm / 9 7/8"

Gesamtgewicht  
Total weight  
Peso total  
Poids total  
Peso totale

**510 g**

## Hämmer

Mallets

Martillos

Maillets

Martelli

Sic

Ø Kopf  
Ø Head  
Ø Cabeza  
Ø Tête  
Ø Testa  
**34 mm**

Kopfgewicht  
Head weight  
Peso de la cabeza  
Poids de tête  
Peso della testa  
**530 g**

Ø Kopf  
Ø Head  
Ø Cabeza  
Ø Tête  
Ø Testa  
**49 mm**

Kopfgewicht  
Head weight  
Peso de la cabeza  
Poids de tête  
Peso della testa  
**770 g**



1/2

23-260-01-04

25 cm / 9 7/8"

Gesamtgewicht

Total weight

Peso total

Poids total

Peso totale

**770 g**



1/2

23-260-02-04

25 cm / 9 7/8"

Gesamtgewicht

Total weight

Peso total

Poids total

Peso totale

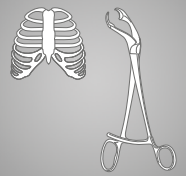
**1010 g**

## Scharfe Löffel

Bone Curettes  
Cucharillas cortantes  
Curettes tranchantes  
Curette taglienti

## Knochenchirurgie

Bone Surgery  
Cirugía ósea  
Chirurgie osseuse  
Chirurgia ossea



Sic

1/1



**2,5 mm**  
**Fig. 0000**  
23-280-40-04



**3,0 mm**  
**Fig. 000**  
23-280-30-04

1/1



**4,5 mm**  
**Fig. 0**  
23-282-10-04



**5,5 mm**  
**Fig. 1**  
23-282-01-04



**3,5 mm**  
**Fig. 00**  
23-280-20-04



**4,5 mm**  
**Fig. 0**  
23-280-10-04



**6,0 mm**  
**Fig. 2**  
23-282-02-04



**7 mm**  
**Fig. 3**  
23-282-03-04



**5,5 mm**  
**Fig. 1**  
23-280-01-04



**6,0 mm**  
**Fig. 2**  
23-280-02-04



**8,5 mm**  
**Fig. 4**  
23-282-04-04



**7,0 mm**  
**Fig. 3**  
23-280-03-04



**8,5 mm**  
**Fig. 4**  
23-280-04-04



**9,5 mm**  
**Fig. 5**  
23-280-05-04



**11,5 mm**  
**Fig. 6**  
23-280-06-04



1/2

Volkmann  
23-280-01-04 -  
23-280-40-04

17 cm / 6 5/8"  
oval  
oval  
ovalada  
ovale  
ovala



1/2

Volkmann  
23-282-01-04 -  
23-282-10-04

27 cm / 10 5/8"  
oval  
oval  
ovalada  
ovale  
ovala

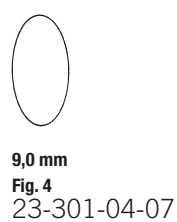
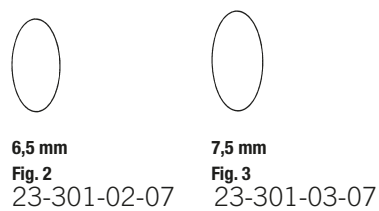
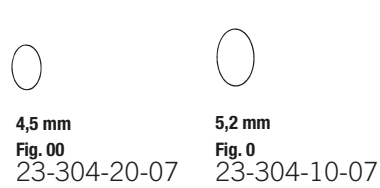
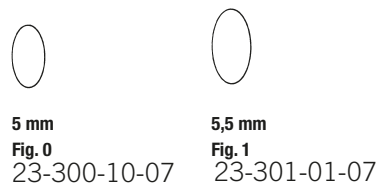
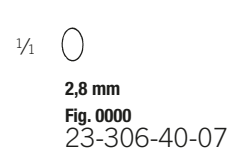
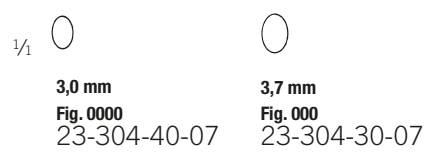
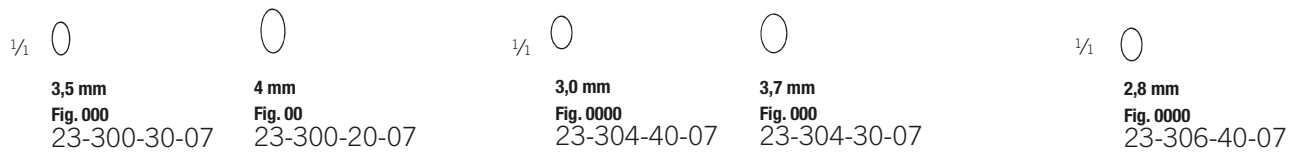
## Scharfe Löffel

Bone Curettes

Cucharillas cortantes

Curettes tranchantes

Curette taglienti



1/2

Schede  
23-300-10-07 -  
23-301-04-07

17 cm / 6 5/8"

oval, mit Hohlheft  
oval, with hollow handle  
ovalada, con mango hueco  
ovale, avec manche creux  
ovala, con manico vuoto



1/2

Volkmann  
23-304-10-07 -  
23-305-06-07

17 cm / 6 5/8"

oval, mit Hohlheft  
oval, with hollow handle  
ovalada, con mango hueco  
ovale, avec manche creux  
ovala, con manico vuoto



1/2

Daubenspeck  
23-306-10-07 -  
23-306-40-07

17 cm / 6 5/8"

oval, mit Hohlheft  
oval, with hollow handle  
ovalada, con mango hueco  
ovale, avec manche creux  
ovale, con manico vuoto

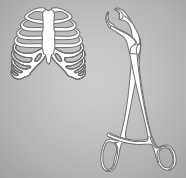


## Scharfe Löffel

Bone Curettes  
Cucharillas cortantes  
Curettes tranchantes  
Curette taglianti

## Knochenchirurgie

Bone Surgery  
Cirugía ósea  
Chirurgie osseuse  
Chirurgia ossea



1/1



Ø 2,0 mm  
Fig. 0000  
23-308-40-07



Ø 3,0 mm  
Fig. 000  
23-308-30-07

1/1



2,5 mm  
Fig. 0000  
23-312-40-07



3,0 mm  
Fig. 000  
23-312-30-07



Ø 4,0 mm  
Fig. 00  
23-308-20-07



Ø 5,0 mm  
Fig. 0  
23-308-10-07



4,0 mm  
Fig. 00  
23-312-20-07



4,5 mm  
Fig. 0  
23-312-10-07



Ø 6,0 mm  
Fig. 1  
23-309-01-07



Ø 8,0 mm  
Fig. 2  
23-309-02-07



5,0 mm  
Fig. 1  
23-313-01-07



6,0 mm  
Fig. 2  
23-313-02-07



Ø 10,0 mm  
Fig. 3  
23-309-03-07



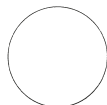
Ø 12,0 mm  
Fig. 4  
23-309-04-07



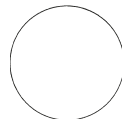
7,0 mm  
Fig. 3  
23-313-03-07



8,0 mm  
Fig. 4  
23-313-04-07



Ø 13,0 mm  
Fig. 5  
23-309-05-07



Ø 14,0 mm  
Fig. 6  
23-309-06-07



9,5 mm  
Fig. 5  
23-313-05-07



1/2

Bruns  
23-308-10-07 -  
23-309-06-07

17 cm / 6 5/8"

rund, mit Hohlheft  
round, with hollow handle  
redonda, con mango hueco  
rond, avec manche creux  
rotonda, con manico vuoto



1/2

Spratt  
23-312-10-07 -  
23-313-05-07

17 cm / 6 5/8"

oval, mit Hohlheft  
oval, with hollow handle  
ovalada, con mango hueco  
ovale, avec manche creux  
ovala, con manico vuoto

# Scharfe Löffel

Bone Curettes

Cucharillas cortantes

Curettes tranchantes

Curette taglienti

1/4



**3,5 mm**  
**Fig. 000**  
23-334-30-07



**4,0 mm**  
**Fig. 00**  
23-334-20-07

1/4



**4,8 mm**  
23-336-25-07

1/4



**2,5 mm**  
**Fig. 1**  
23-340-01-07



**4,5 mm**  
**Fig. 0**  
23-334-10-07



**5,5 mm**  
**Fig. 1**  
23-335-01-07



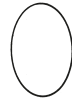
**4,8 mm**  
23-337-25-07



**3,0 mm**  
**Fig. 2**  
23-340-02-07



**6,0 mm**  
**Fig. 2**  
23-335-02-07



**7,5 mm**  
**Fig. 3**  
23-335-03-07



**4,8 mm**  
23-339-25-07



**3,5 mm**  
**Fig. 3**  
23-340-03-07



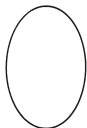
**8,5 mm**  
**Fig. 4**  
23-335-04-07



**10,0 mm**  
**Fig. 5**  
23-335-05-07



**4,0 mm**  
**Fig. 4**  
23-340-04-07



**11,5 mm**  
**Fig. 6**  
23-335-06-07



**4,5 mm**  
**Fig. 5**  
23-340-05-07



**5,5 mm**  
**Fig. 6**  
23-340-06-07

1/2



**Brun's**  
23-334-10-07 -  
23-335-06-07

23 cm / 9 "  
oval, massiv  
oval, solid  
ovalada, maciza  
ovale, solide  
ovala, solida

1/2



**Scoville**  
23-336-25-07 -  
23-339-25-07

25 cm / 9 7/8 "  
oval, mit Hohlheft  
oval, with hollow handle  
ovalada, con mango hueco  
ovale, avec manche creux  
ovala, con manico vuoto

1/2



**Simon**  
23-340-01-07 -  
23-340-06-07

22,5 cm / 8 7/8 "  
oval, mit Hohlheft  
oval, with hollow handle  
ovalada, con mango hueco  
ovale, avec manche creux  
ovala, con manico vuoto

## Scharfe Löffel

Bone Curettes

Cucharillas cortantes

Curettes tranchantes

Curette taglianti

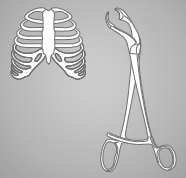
## Knochenchirurgie

Bone Surgery

Cirugía ósea

Chirurgie osseuse

Chirurgia ossea



1/1

3,5 mm  
Fig. 000  
23-342-30-07

1/1

2,3 mm  
Fig. 1  
23-344-01-07

1/1



4,8 mm  
Fig. 1  
23-350-01-07



4,5 mm  
Fig. 00  
23-342-20-07



2,6 mm  
Fig. 2  
23-344-02-07



5,8 mm  
Fig. 2  
23-350-02-07



5,0 mm  
Fig. 0  
23-342-10-07



3,0 mm  
Fig. 3  
23-344-03-07



6,8 mm  
Fig. 3  
23-350-03-07



6,0 mm  
Fig. 1  
23-342-01-07



3,5 mm  
Fig. 4  
23-344-04-07



4,5 mm  
Fig. 5  
23-344-05-07



5,0 mm  
Fig. 6  
23-344-06-07



1/2



1/2



1/2

23-342-01-07 -  
23-342-30-07

25 cm / 9 7/8"

oval, mit Hohlheft  
oval, with hollow handle  
ovalada, con mango hueco  
ovale, avec manche creux  
ovala, con manico vuoto

Modell USA  
23-344-01-07 -  
23-344-06-07

16,5 cm / 6 1/2"

oval, mit Hohlheft  
oval, with hollow handle  
ovalada, con mango hueco  
ovale, avec manche creux  
ovala, con manico vuoto

Halle  
23-350-01-07 -  
23-350-03-07

21 cm / 8 2/8"

oval, biegsamer Schaft, mit Hohlheft  
oval, malleable shaft, with hollow handle  
ovalada, vástago maleable, con mango hueco  
ovale, tige malléable, avec manche creux  
ovala, gambo malleable, con manico vuoto

# Scharfe Löffel

Bone Curettes

Cucharillas cortantes

Curettes tranchantes

Curette taglienti



Jacobson  
23-351-14-07  
14 cm / 5 4/8"



Volkman  
23-352-13-07 -  
23-352-17-07



6,1 mm

23-352-13-07  
12,5 cm / 4 7/8"



6,2 mm

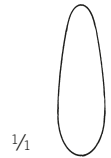
23-352-14-07  
14,5 cm / 5 6/8"



6,2 mm

23-352-17-07  
17 cm / 6 6/8"

7,2 mm



1/1

6,8 mm



7,5 mm



Ø 6,5 mm

1/2

1/1

23-356-21-07  
21 cm / 8 2/8"



1/2



Ø 6,5 mm

23-354-13-07  
13 cm / 5 1/8"

6,0 mm



1/1

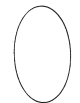
Volkman  
23-354-13-07 -  
23-354-20-07



Ø 9,0 mm

23-354-16-07  
16 cm / 6 2/8"

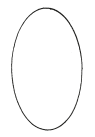
7,0 mm



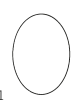
Ø 11,0 mm

23-354-20-07  
20 cm / 7 7/8"

9,0 mm



6,0 mm

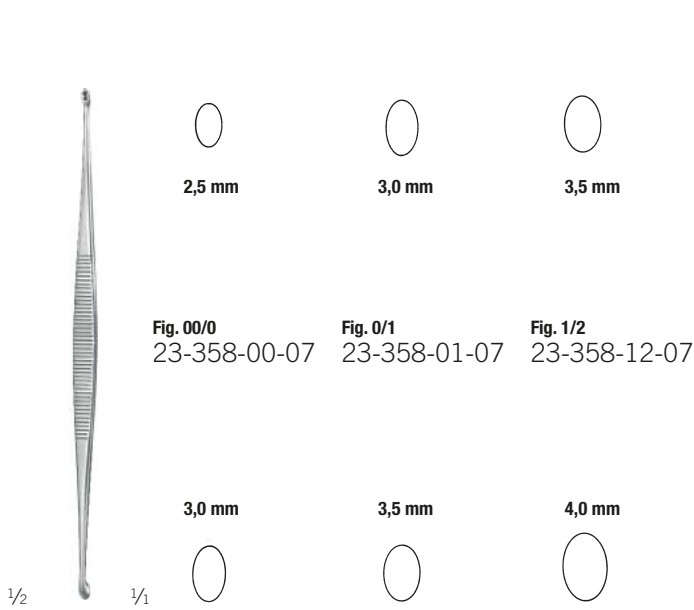
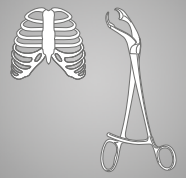


# Scharfe Doppellöffel, Scharfe Küretten

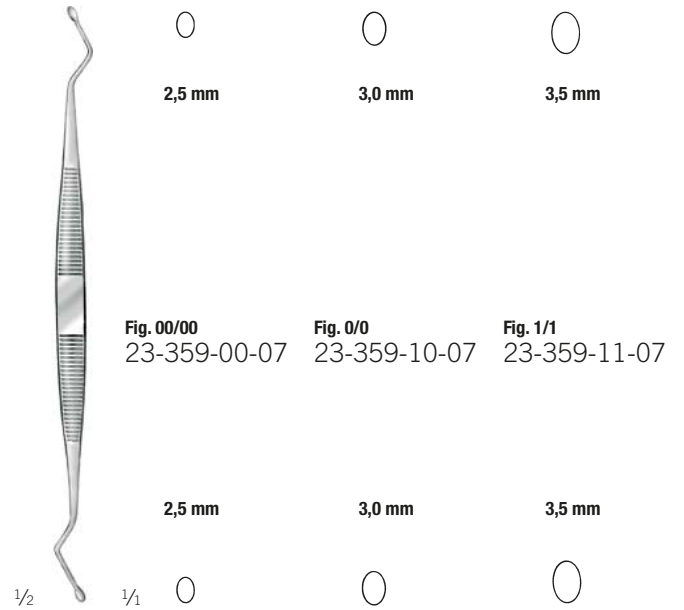
Bone Curettes, double-ended, Bone Curettes  
 Cucharillas de doble extremo, Curetas cortantes  
 Curettes doubles, Curettes  
 Curette doppia, Curette

# Knochenchirurgie

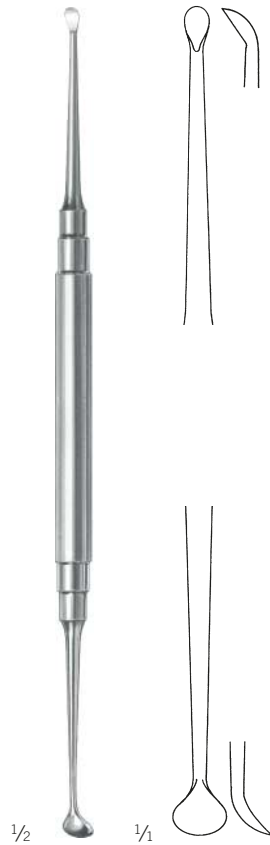
Bone Surgery  
 Cirugía ósea  
 Chirurgie osseuse  
 Chirurgia ossea



Williger  
 23-358-00-07 -  
 23-358-12-07  
 14 cm / 5 1/8"  
 oval  
 oval  
 ovalada  
 ovale  
 ovale



Williger  
 23-359-00-07 -  
 23-359-11-07  
 16,5 cm / 6 1/2"  
 oval  
 oval  
 ovalada  
 ovale  
 ovale



Molt  
 23-395-24-07  
 19 cm / 7 1/2"

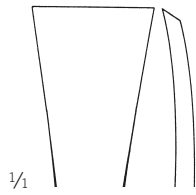
## Raspatorien

Periosteal Elevators

Periostótomos

Rugines-raspatoires

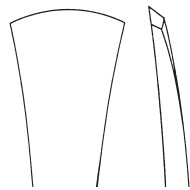
Periostotomi



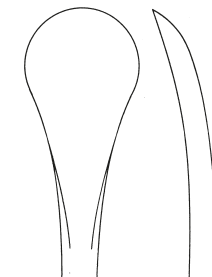
**16 mm**  
23-400-01-07  
19 cm / 7 4/8"



**7 mm**  
23-400-10-07  
16 cm / 6 2/8"



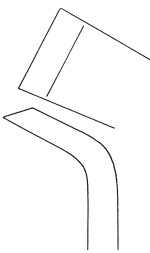
**16 mm**  
23-400-02-07  
20 cm / 7 7/8"



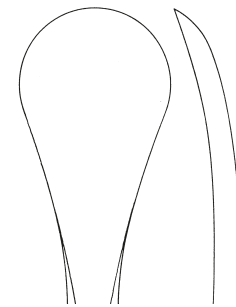
**15 mm**  
23-400-11-07  
18,5 cm / 7 2/8"



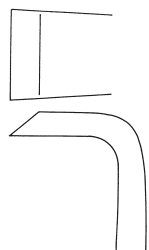
1/2



**12 mm**  
23-400-03-07  
19 cm / 7 4/8"



**20 mm**  
23-400-12-07  
19 cm / 7 4/8"



**12 mm**  
23-400-04-07  
18 cm / 7 1/8"



1/2

Martin-Langenbeck  
23-400-01-07 -  
23-400-04-07

massiv  
solid  
macizo  
solide  
pieno

Martin-Hoen  
23-400-10-07 -  
23-400-12-07

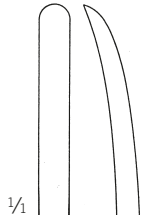
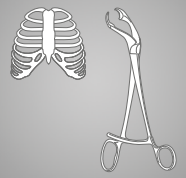
massiv  
solid  
macizo  
solide  
pieno

## Raspatorien

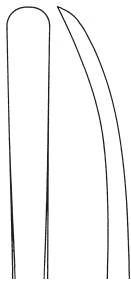
Periosteal Elevators  
Periostótomos  
Rugines-raspatoires  
Periostotomi

## Knochenchirurgie

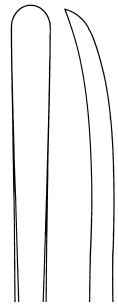
Bone Surgery  
Cirugía ósea  
Chirurgie osseuse  
Chirurgia ossea



**4 mm**  
23-400-20-07  
17,5 cm / 7"



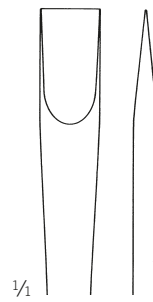
**6 mm**  
23-400-21-07  
17,5 cm / 7"



**5 mm**  
23-400-25-07  
19,5 cm / 7 5/8"



**7 mm**  
23-400-26-07  
19,5 cm / 7 5/8"



**8 mm**



1/2

Martin-Cushing  
23-400-20-07 -  
23-400-26-07

massiv  
solid  
macizo  
solide  
pieno



1/2

Martin-Cushing  
23-400-30-07  
17 cm / 6 5/8"

massiv  
solid  
macizo  
solide  
pieno

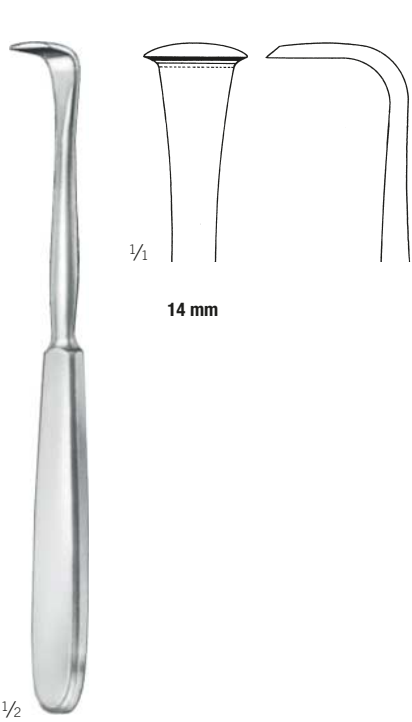
## Raspatorien

Periosteal Elevators

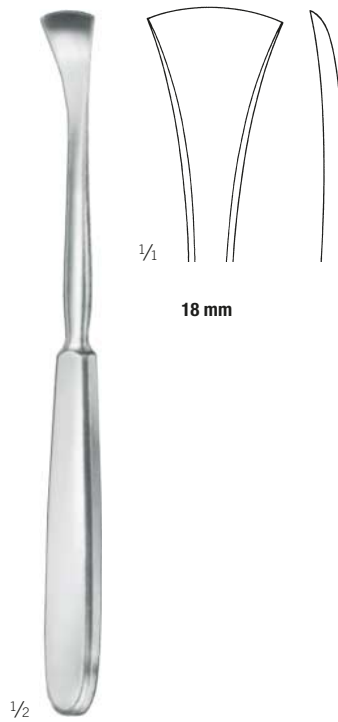
Periostótomos

Rugines-raspatoires

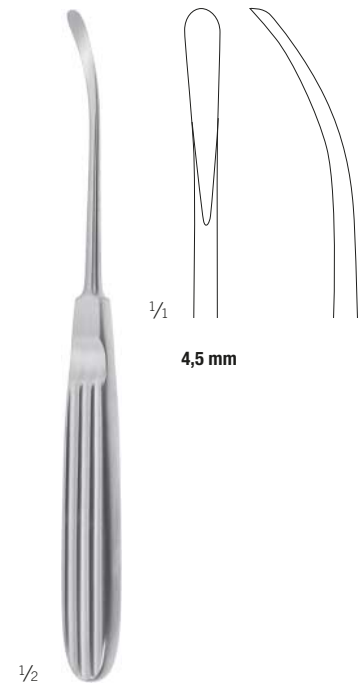
Periostotomi



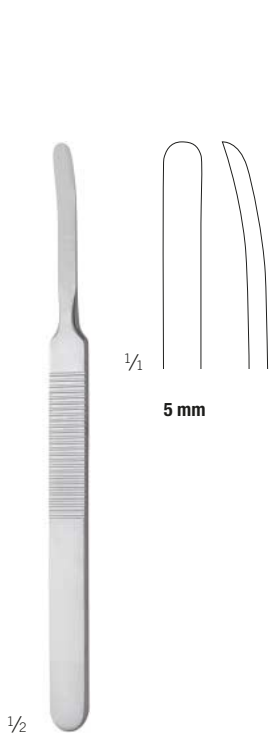
Langenbeck  
23-401-18-07  
18 cm / 7 1/8"  
mit Hohlheft  
with hollow handle  
con mango hueco  
avec manche creux  
con manico vuoto



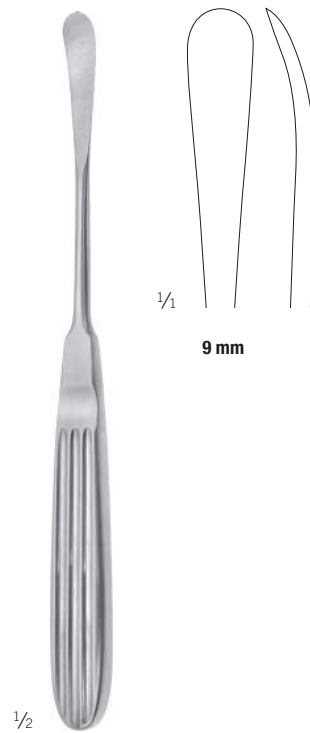
Langenbeck  
23-402-19-07  
19 cm / 7 5/8"  
mit Hohlheft  
with hollow handle  
con mango hueco  
avec manche creux  
con manico vuoto



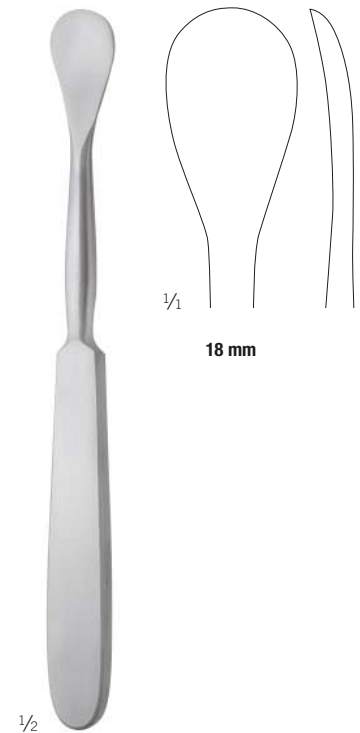
Landolt  
23-404-18-07  
17,5 cm / 6 7/8"



König  
23-406-16-07  
15,5 cm / 6 1/8"



Cottle  
23-412-20-07  
19,5 cm / 7 5/8"



Sedillot  
23-414-19-07  
18,5 cm / 7 2/8"

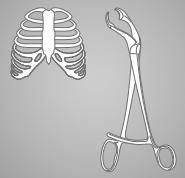


## Raspatorien

Periosteal Elevators  
 Periostótomos  
 Rugines-raspatoires  
 Periostotomi

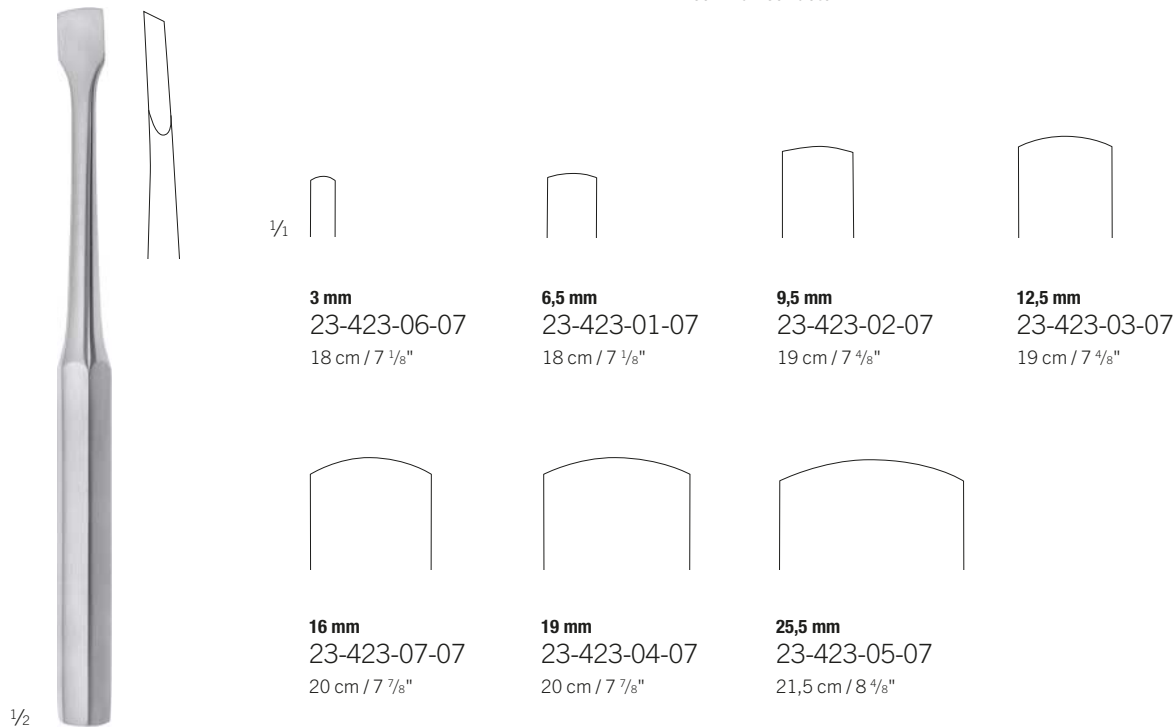
## Knochenchirurgie

Bone Surgery  
 Cirugía ósea  
 Chirurgie osseuse  
 Chirurgia ossea



Farabeuf-Collin  
 23-416-11-07 -  
 23-417-11-07  
 15,5 cm / 6 1/8"

Farabeuf  
 23-418-15-07 -  
 23-419-15-07  
 15,5 cm / 6 1/8"  
 mit Hohlheft  
 with hollow handle  
 con mango hueco  
 avec manche creux  
 con manico vuoto



Key  
 23-423-01-07 -  
 23-423-07-07

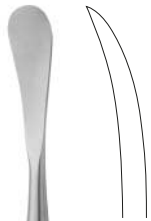
## Raspatorien

Periosteal Elevators

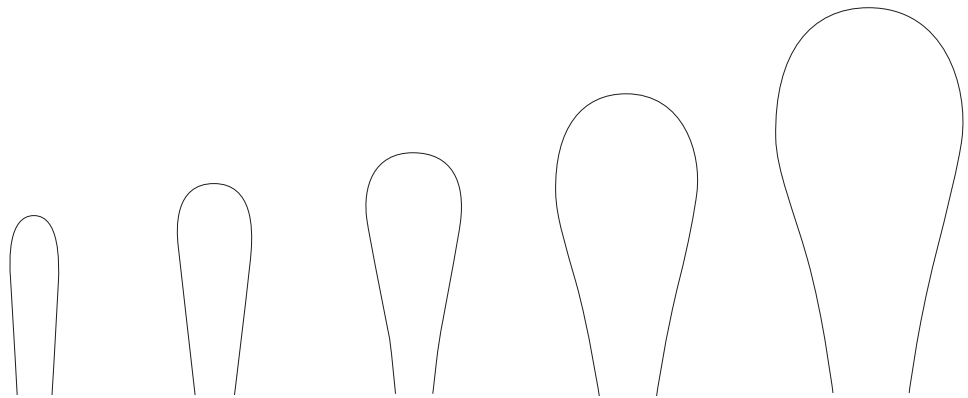
Periostótomos

Rugines-raspatoires

Periostotomi



1/1



|             | 6 mm         | 10 mm        | 13 mm        | 19 mm        | 25 mm        |
|-------------|--------------|--------------|--------------|--------------|--------------|
| 23 cm / 9"  | 23-426-06-07 | 23-426-10-07 | 23-426-13-07 | 23-426-19-07 | 23-426-25-07 |
| 28 cm / 11" | 23-425-06-07 | 23-425-10-07 | 23-425-13-07 | 23-425-19-07 | 23-425-25-07 |

1/2



Cobb  
23-425-06-07 -  
23-426-25-07

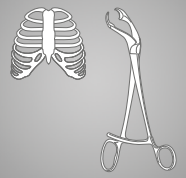
1/2

## Raspatorien

Periosteal Elevators  
Periostótomos  
Rugines-raspatoires  
Periostotomi

## Knochenchirurgie

Bone Surgery  
Cirugía ósea  
Chirurgie osseuse  
Chirurgia ossea



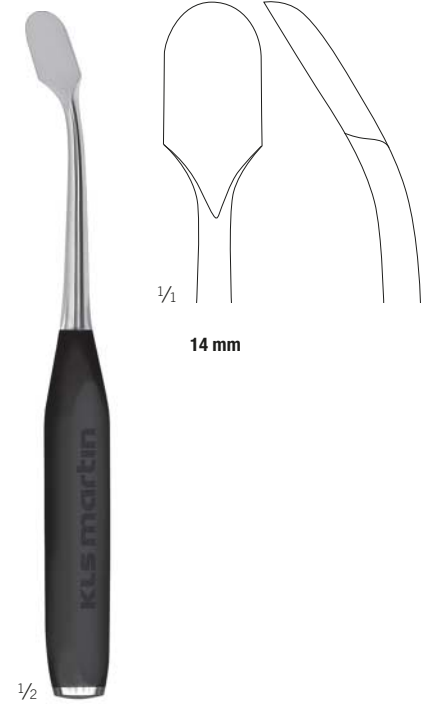
Sic



23-428-06-04  
20 cm / 7 7/8"



23-429-14-04  
20 cm / 7 7/8"



23-432-14-04  
20 cm / 7 7/8"



23-432-18-04  
20 cm / 7 7/8"



23-433-03-04  
20 cm / 7 7/8"



23-433-13-04  
20 cm / 7 7/8"

23

## Raspatorien

Periosteal Elevators

Periostótomos

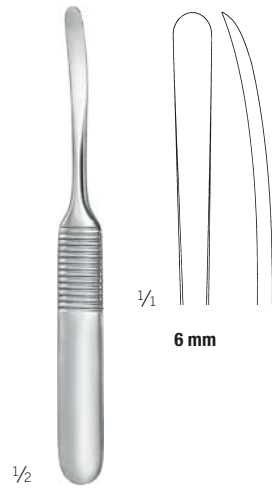
Rugines-raspatoires

Periostotomi



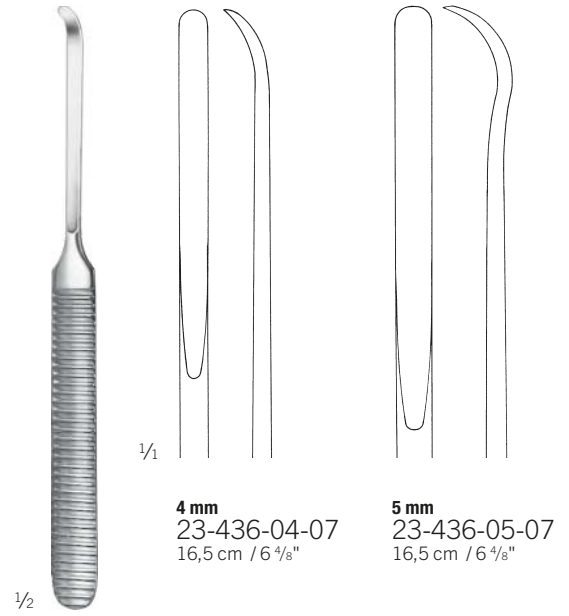
23-433-18-04  
20 cm / 7 7/8"

**Sic**



Williger  
23-434-13-07  
12,5 cm / 4 7/8"

massiv  
solid  
macizo  
solide  
pieno

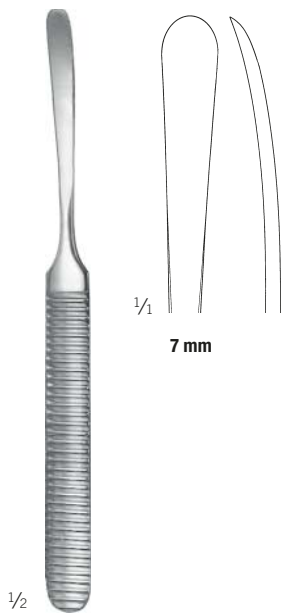


4 mm  
23-436-04-07  
16,5 cm / 6 4/8"

5 mm  
23-436-05-07  
16,5 cm / 6 4/8"

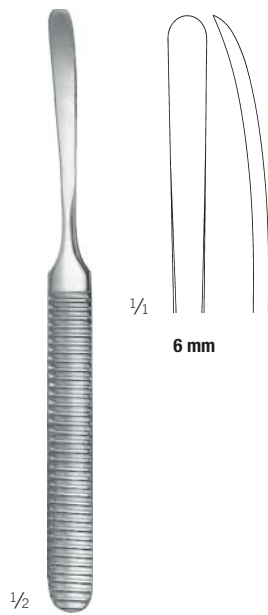
Kahre-Williger  
23-436-04-07 -  
23-436-05-07

16,5 cm / 6 4/8"  
massiv  
solid  
macizo  
solide  
pieno



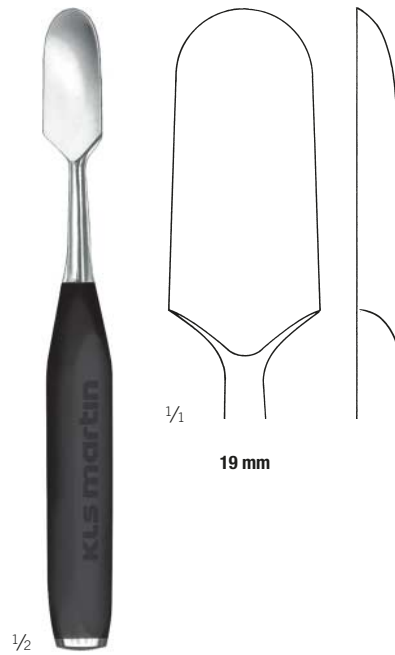
Williger  
23-436-07-07  
16 cm / 6 1/8"

massiv  
solid  
macizo  
solide  
pieno



Williger  
23-436-16-07  
16 cm / 6 1/8"

massiv  
solid  
macizo  
solide  
pieno



23-437-20-04  
20 cm / 7 7/8"

**Sic**



23-439-08-07

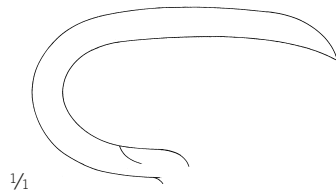
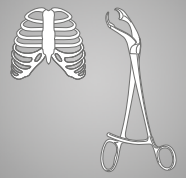
17 cm / 6 5/8"  
mit Hohlheft  
with hollow handle  
con mango hueco  
avec manche creux  
con manico vuoto

## Raspatorien

Periosteal Elevators  
Periostótomos  
Rugines-raspatoires  
Periostotomi

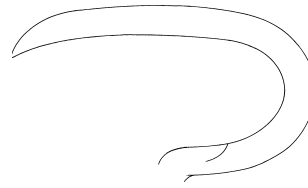
## Knochenchirurgie

Bone Surgery  
Cirugía ósea  
Chirurgie osseuse  
Chirurgia ossea



1/1

23-441-17-07  
17 cm / 6 5/8"

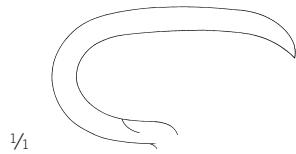


23-443-17-07  
17 cm / 6 5/8"

für Erwachsene  
for adults  
para adultos  
pour adultes  
per adulti



1/2



1/1

23-445-17-07  
18 cm / 7 1/8"



23-447-17-07  
18 cm / 7 1/8"

für Kinder  
for children  
para niños  
pour enfants  
per bambini

Doyen  
23-441-17-07 -  
23-447-17-07

Rippenraspatorien, mit Hohlheft  
Rib Raspatories, with hollow handle  
Legras costales, con mango hueco  
Rugines pour le périoste costale, avec manche creux  
Periostotomi costali, con manico vuoto

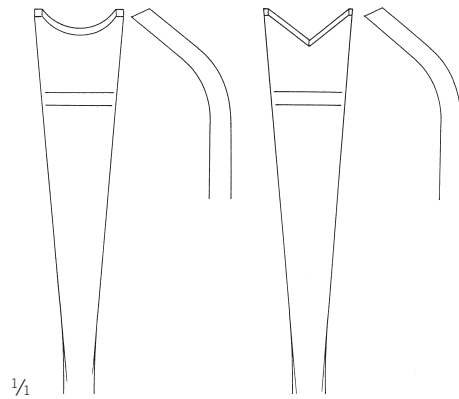
# Raspatorien

Periosteal Elevators

Periostótomos

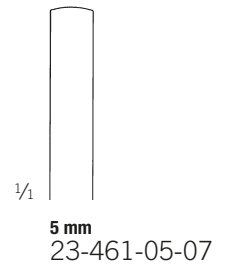
Rugines-raspatoires

Periostotomi

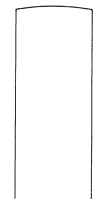


$\frac{1}{2}$   
**12 mm**  
**Fig. 1**  
 23-450-01-07  
 19 cm / 7  $\frac{4}{8}$ "

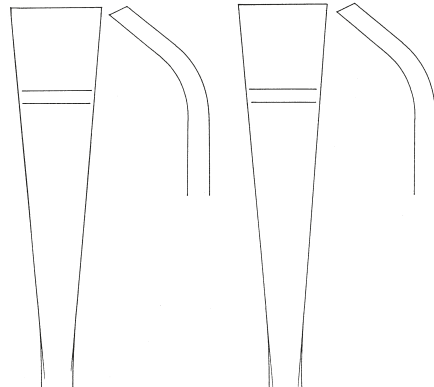
$\frac{1}{2}$   
**12 mm**  
**Fig. 2**  
 23-450-02-07  
 22 cm / 8  $\frac{5}{8}$ "



$\frac{1}{4}$   
**5 mm**  
 23-461-05-07

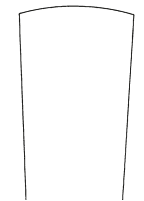


**10 mm**  
 23-461-10-07

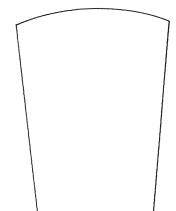


$\frac{1}{2}$   
**13 mm**  
**Fig. 3**  
 23-450-03-07  
 19 cm / 7  $\frac{4}{8}$ "

$\frac{1}{2}$   
**13 mm**  
**Fig. 4**  
 23-450-04-07  
 22 cm / 8  $\frac{5}{8}$ "



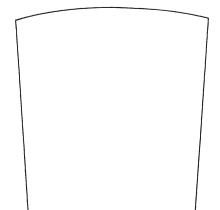
**15 mm**  
 23-461-15-07



**20 mm**  
 23-461-20-07



$\frac{1}{2}$   
**15 mm**  
**Fig. 5**  
 23-450-05-07  
 23 cm / 9"



**25 mm**  
 23-461-25-07



$\frac{1}{2}$   
**Alexander**  
 23-448-21-07  
 21 cm / 8  $\frac{3}{8}$ "



$\frac{1}{2}$   
**Semb**  
 23-450-01-07 -  
 23-450-05-07



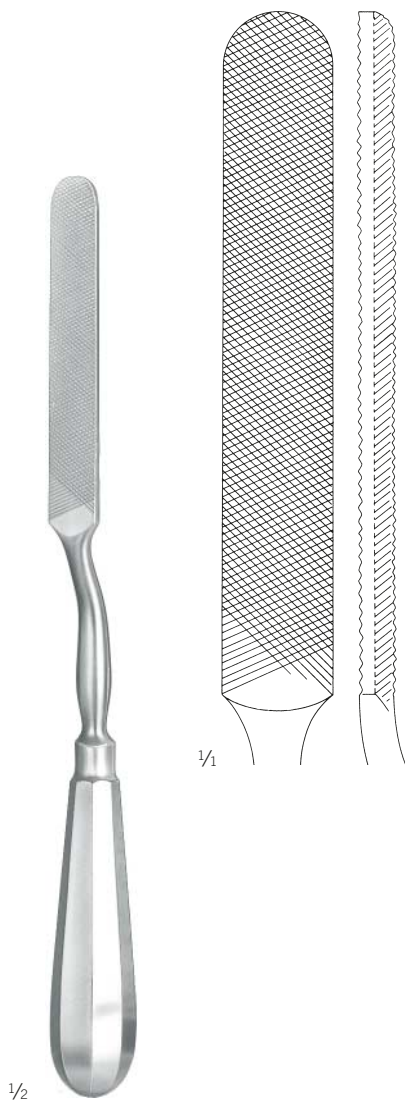
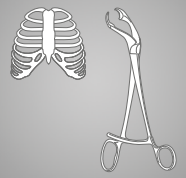
$\frac{1}{2}$   
**Lambotte**  
 23-461-05-07 -  
 23-461-25-07  
 21,5 cm / 8  $\frac{4}{8}$ "

## Knochenfeilen

Bone Files  
Limas para huesos  
Limes à os  
Lime per ossa

## Knochenchirurgie

Bone Surgery  
Cirugía ósea  
Chirurgie osseuse  
Chirurgia ossea



23-481-24-07

25 cm / 9 7/8"

halbrund, mit Hohlheft  
semi-round, with hollow handle  
semi-redonda, con mango hueco  
semi-ronde, avec manche creux  
semi-rotonda, con manico vouto



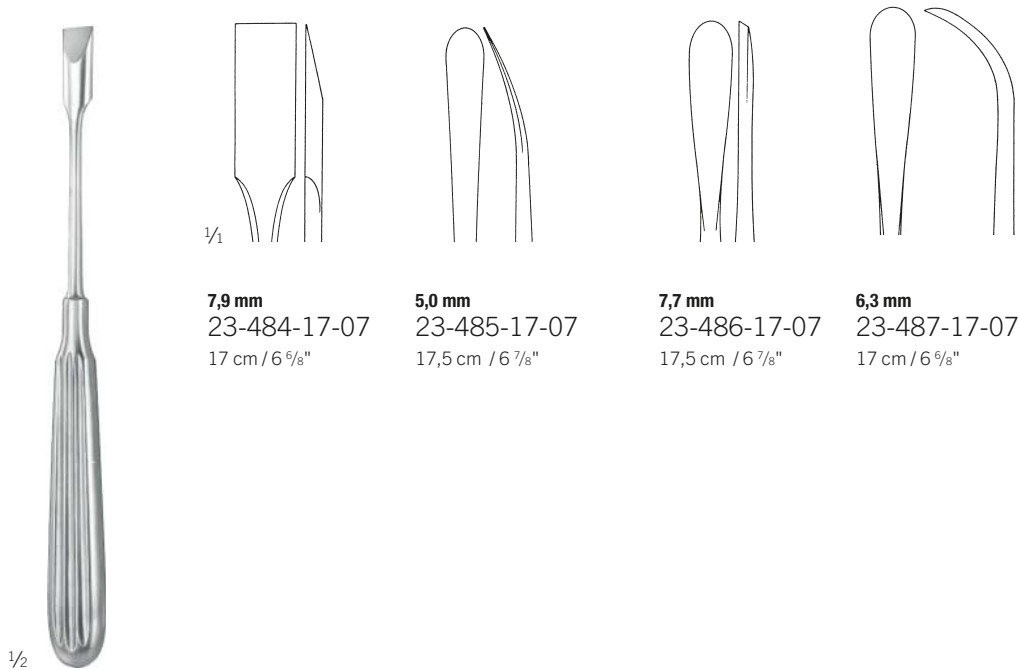
23-482-22-07

22 cm / 8 5/8"

flach, massiv  
flat, solid  
plana, maciza  
plata, solide  
plana, solida

## Elevatoren, Knochenfeilen

Elevators, Bone Files  
 Elevadores, Limas para huesos  
 Elévateurs, Limes à os  
 Elevatori, Lime per ossa



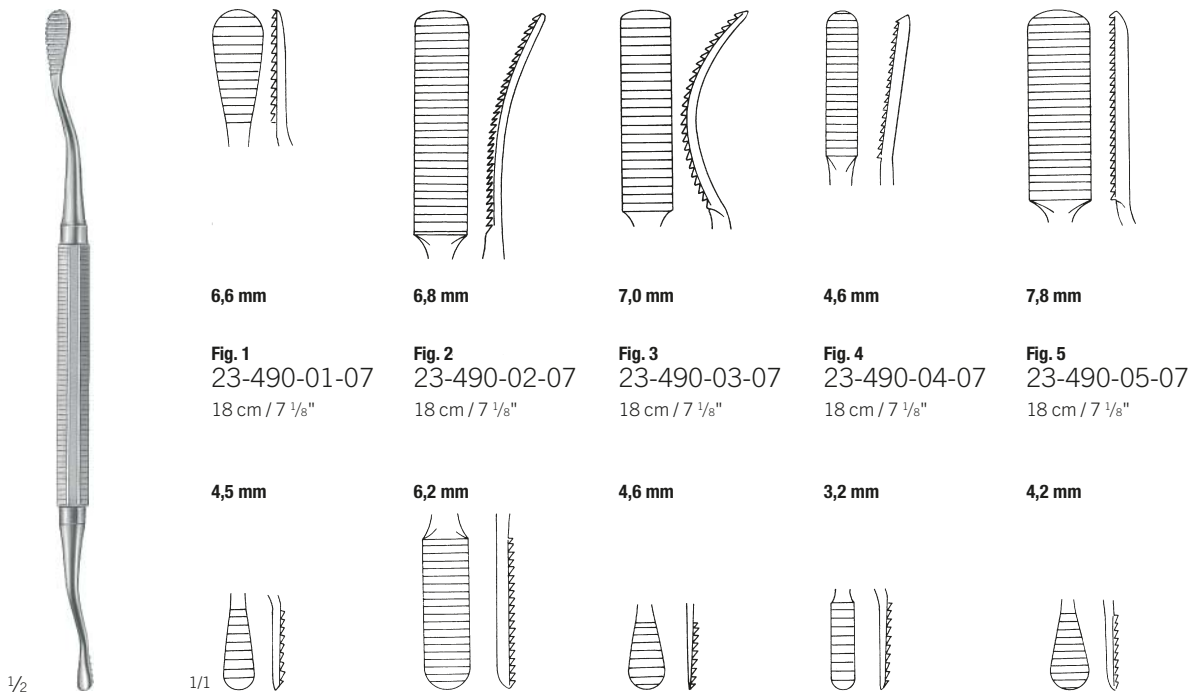
**7,9 mm**  
 23-484-17-07  
 17 cm / 6 5/8"

**5,0 mm**  
 23-485-17-07  
 17,5 cm / 6 7/8"

**7,7 mm**  
 23-486-17-07  
 17,5 cm / 6 7/8"

**6,3 mm**  
 23-487-17-07  
 17 cm / 6 5/8"

Adson  
 23-484-17-07 -  
 23-487-17-07



**6,6 mm**  
**Fig. 1**  
 23-490-01-07  
 18 cm / 7 1/8"

**6,8 mm**  
**Fig. 2**  
 23-490-02-07  
 18 cm / 7 1/8"

**7,0 mm**  
**Fig. 3**  
 23-490-03-07  
 18 cm / 7 1/8"

**4,6 mm**  
**Fig. 4**  
 23-490-04-07  
 18 cm / 7 1/8"

**7,8 mm**  
**Fig. 5**  
 23-490-05-07  
 18 cm / 7 1/8"

**4,5 mm**

**6,2 mm**

**4,6 mm**

**3,2 mm**

**4,2 mm**

Miller-Colburn  
 23-490-01-07 -  
 23-490-05-07

auf Zug schneidend  
 downwards cutting  
 corte abajo  
 tranchant en bas  
 tagliente in basso



## Knochenfeilen, Alveotomiefeilen

Bone Files, Alveotomy Files

Limas para huesos, Limas para alveolotomí

Limes à os, Limes pour alvéolotomie

Lime per ossa, Lime per alveolotomia

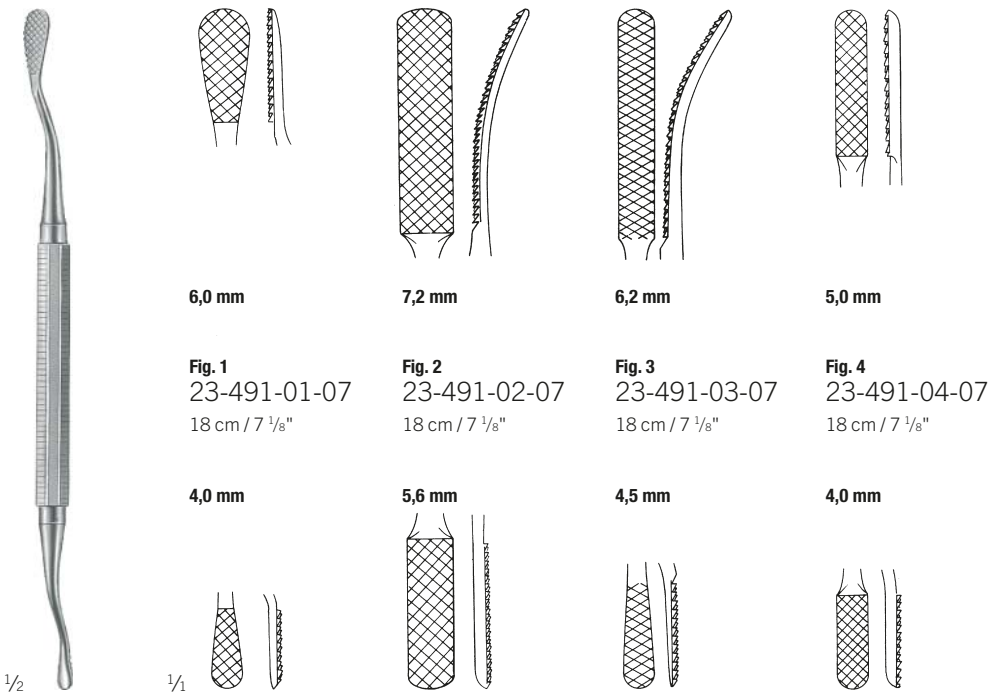
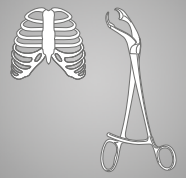
## Knochenchirurgie

Bone Surgery

Cirugía ósea

Chirurgie osseuse

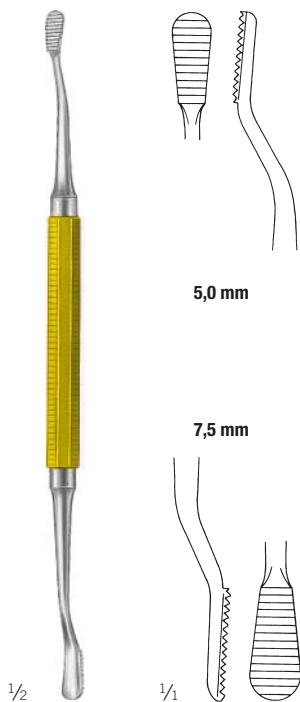
Chirurgia ossea



Miller-Colburn  
23-491-01-07 -  
23-491-04-07

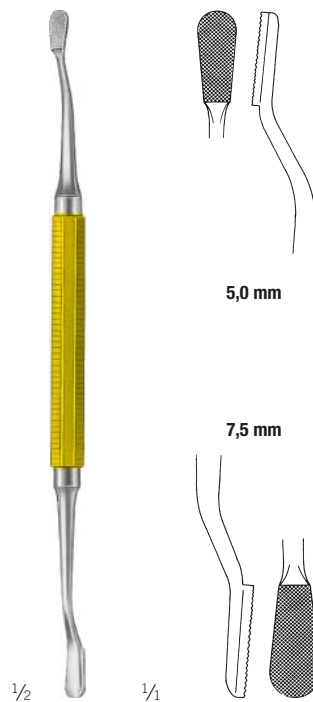
Kreuzhieb  
cross cut  
picado en cruz  
taille croisée  
tagliente a croce

## TC GOLD



Miller  
23-492-01-07  
19 cm / 7 4/8"

## TC GOLD



Miller  
23-493-01-07  
19 cm / 7 4/8"

## Elevatorien

Elevators  
Elevadores  
Elévateurs  
Elevatori



1/1



**7 mm**  
23-495-20-07  
19,5 cm / 7 5/8"

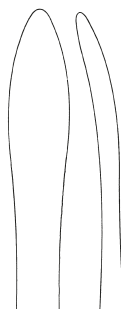
**10 mm**  
23-497-20-07  
19,5 cm / 7 5/8"

1/2

Langenbeck  
23-495-20-07 -  
23-497-20-07



1/1



**5 mm**  
23-499-01-07  
17 cm / 6 5/8"

**7 mm**  
23-499-02-07  
17 cm / 6 5/8"

**8 mm**  
23-499-03-07  
19,5 cm / 7 5/8"

**10 mm**  
23-499-04-07  
19,5 cm / 7 5/8"

1/2

Martin-Langenbeck  
23-499-01-07 -  
23-499-04-07

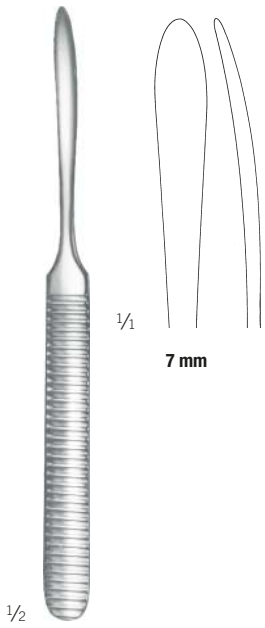
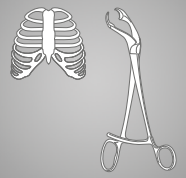
massiv  
solid  
macizo  
solide  
pieno

# Elevatorien

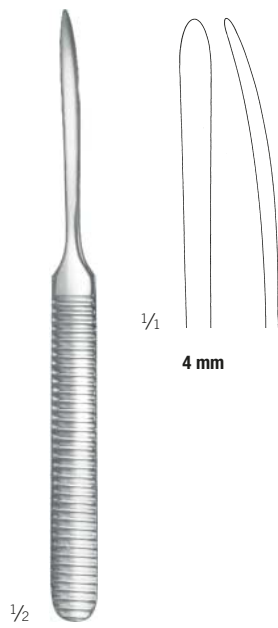
Elevators  
Elevadores  
Elévateurs  
Elevatori

# Knochenchirurgie

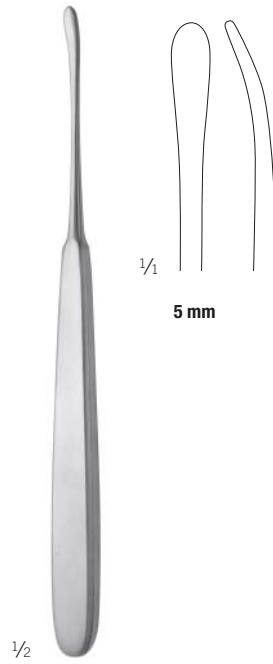
Bone Surgery  
Cirugía ósea  
Chirurgie osseuse  
Chirurgia ossea



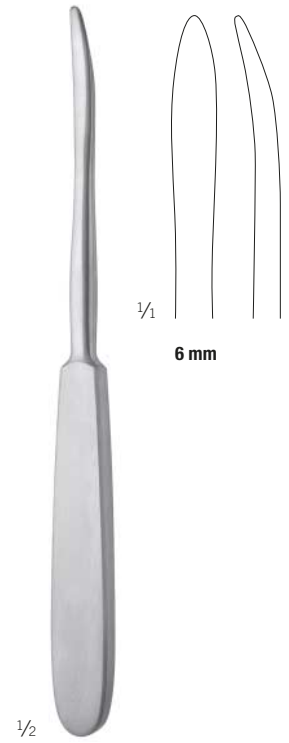
**Williger**  
23-510-17-07  
17 cm / 6 5/8"  
massiv  
solid  
macizo  
solide  
pieno



**Williger**  
23-513-16-07  
16 cm / 6 1/8"  
massiv  
solid  
macizo  
solide  
pieno



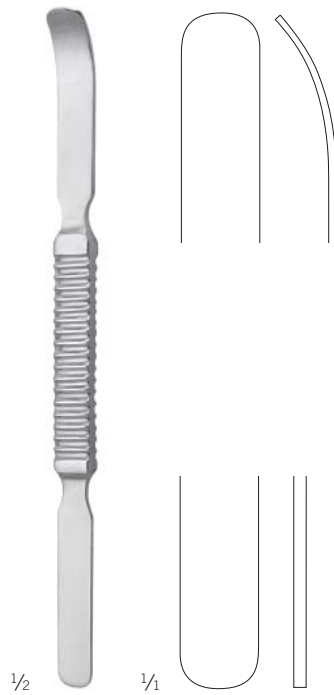
**Sebileau**  
23-516-18-07  
17,5 cm / 6 7/8"



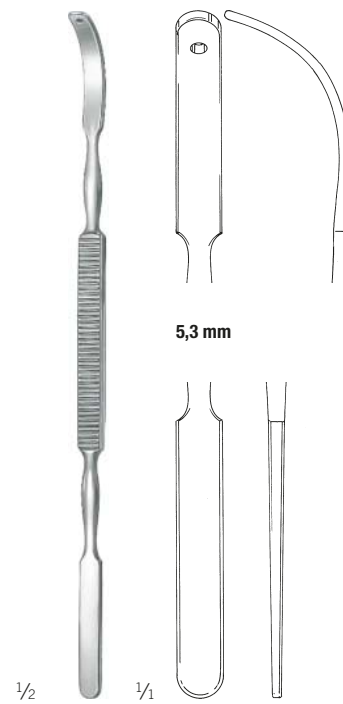
**Quervain**  
23-517-20-07  
19,5 cm / 7 5/8"



**Alderdyce**  
23-525-21-07  
21 cm / 8 1/8"



**23-526-18-07**  
18 cm / 7 1/8"



**McDonald**  
23-527-19-07  
18,5 cm / 7 3/8"

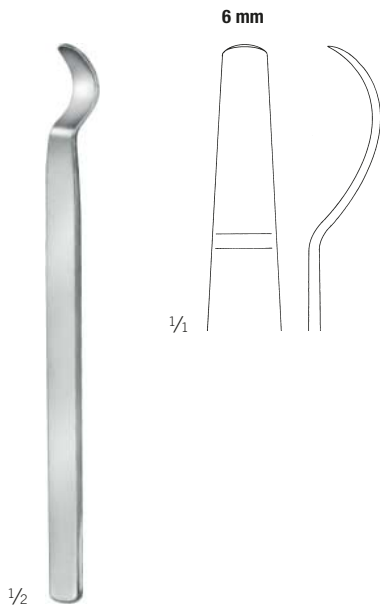
# Knochenheber

Bone Levers

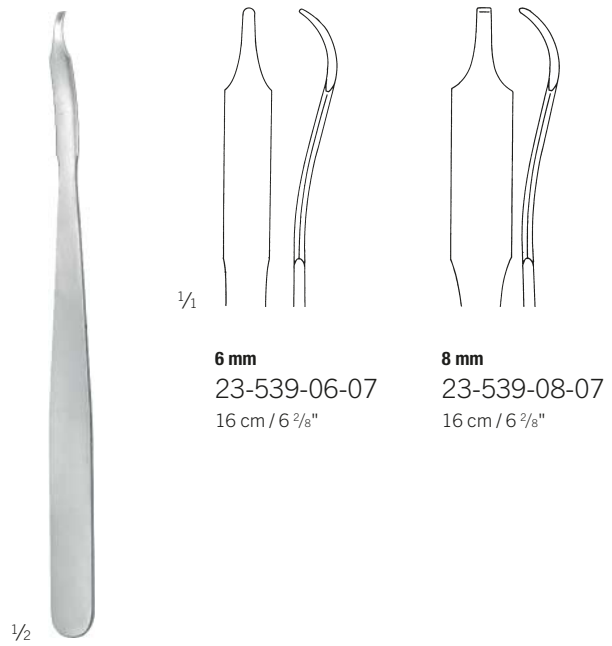
Elevadores para hueso

Leviers à os

Elevatori per ossa



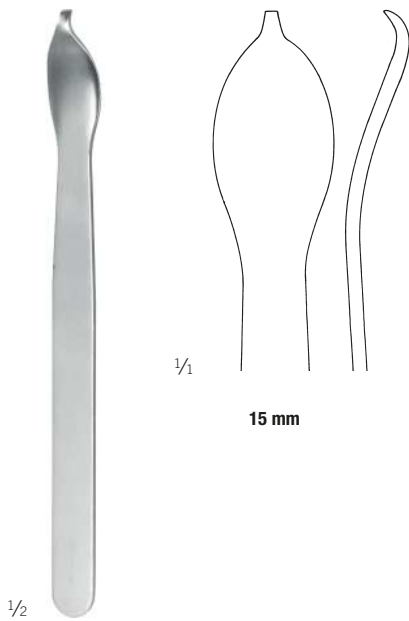
23-537-06-07  
15 cm / 5 7/8"



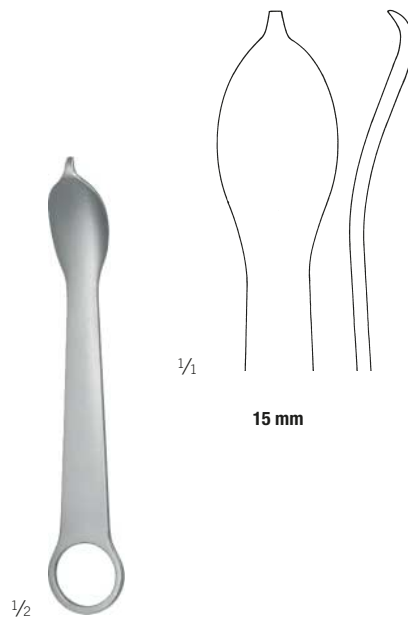
6 mm  
23-539-06-07  
16 cm / 6 2/8"

8 mm  
23-539-08-07  
16 cm / 6 2/8"

Hohmann, mini  
23-539-06-07 -  
23-539-08-07  
16 cm / 6 2/8"



23-539-15-07  
16 cm / 6 2/8"



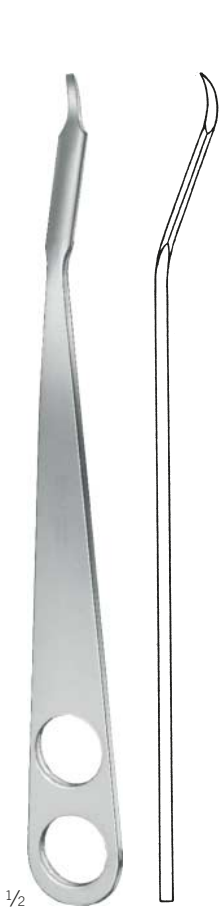
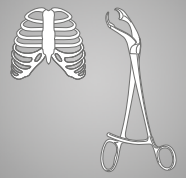
23-539-16-07  
12 cm / 4 6/8"

## Knochenheber

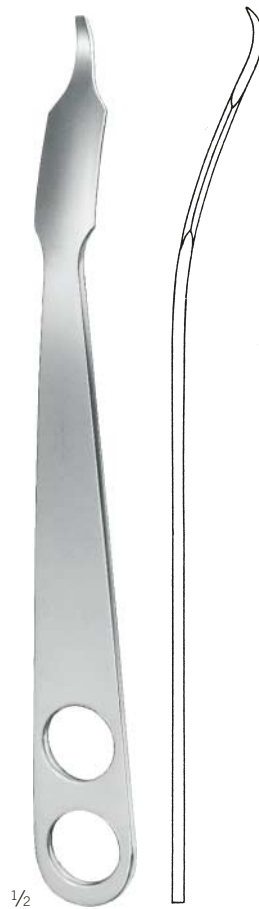
Bone Levers  
Elevadores para hueso  
Leviers à os  
Elevatori per ossa

## Knochenchirurgie

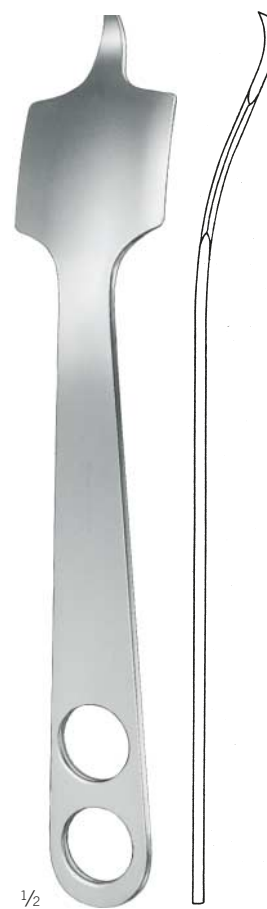
Bone Surgery  
Cirugía ósea  
Chirurgie osseuse  
Chirurgia ossea



**8 mm**  
Hohmann  
23-541-08-07  
21,5 cm / 8 5/8"  
schmale Spitze  
narrow tip  
punta estrecha  
pointe étroite  
punta stretta



**18 mm**  
Hohmann  
23-541-18-07  
23,5 cm / 9 2/8"  
schmale Spitze  
narrow tip  
punta estrecha  
pointe étroite  
punta stretta



**43 mm**  
Hohmann  
23-541-43-07  
23,5 cm / 9 2/8"  
schmale Spitze  
narrow tip  
punta estrecha  
pointe étroite  
punta stretta

## Knochenheber

Bone Levers

Elevadores para hueso

Leviers à os

Elevatori per ossa



1/2

**70 mm**  
Hohmann  
23-541-70-07

25 cm / 9 7/8"

schmale Spitze  
narrow tip  
punta estrecha  
pointe étroite  
punta stretta

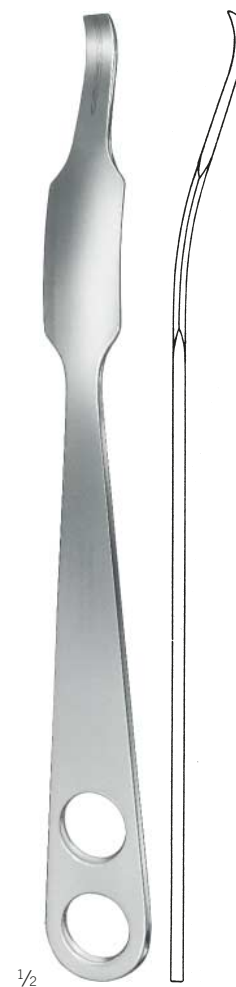


1/2

**43 mm**  
Hohmann  
23-543-43-07

23,5 cm / 9 3/8"

schmale Spitze  
narrow tip  
punta estrecha  
pointe étroite  
punta stretta



1/2

**22 mm**  
Hohmann  
23-545-22-07

25,5 cm / 10"

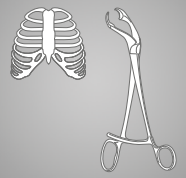
breite Spitze  
wide tip  
punta ancha  
pointe large  
punta larga

## Knochenheber

Bone Levers  
Elevadores para hueso  
Leviers à os  
Elevatori per ossa

## Knochenchirurgie

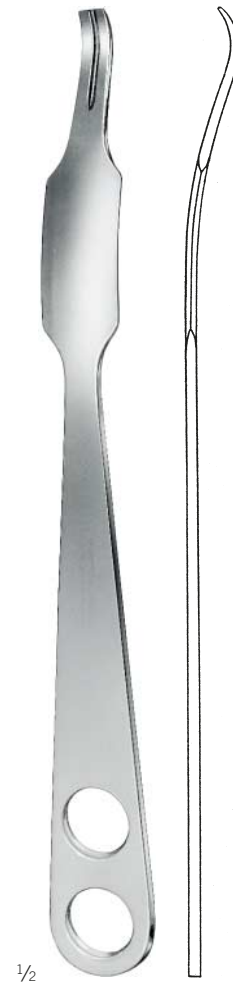
Bone Surgery  
Cirugía ósea  
Chirurgie osseuse  
Chirurgia ossea



**35 mm**  
Hohmann  
23-545-35-07  
29 cm / 11 <sup>3</sup>/<sub>8</sub>"  
breite Spitze  
wide tip  
punta ancha  
pointe large  
punta larga



**24 mm**  
Hohmann  
23-547-24-07  
27,5 cm / 10 <sup>7</sup>/<sub>8</sub>"  
breites, rundes Ende  
wide, round tip  
punta ancha, redonda  
pointe large, ronde  
punta larga, rotonda



**22 mm**  
Lange-Hohmann  
23-549-22-07  
25 cm / 9 <sup>7</sup>/<sub>8</sub>"  
breite Spitze mit Längsrille  
wide tip with groove  
punta ancha con ranura  
pointe large avec rainure  
punta larga con scanallatura

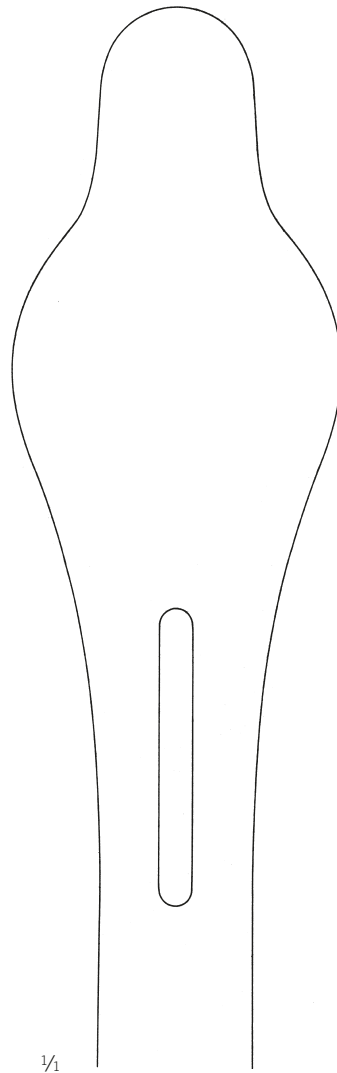
# Knochenheber

Bone Levers

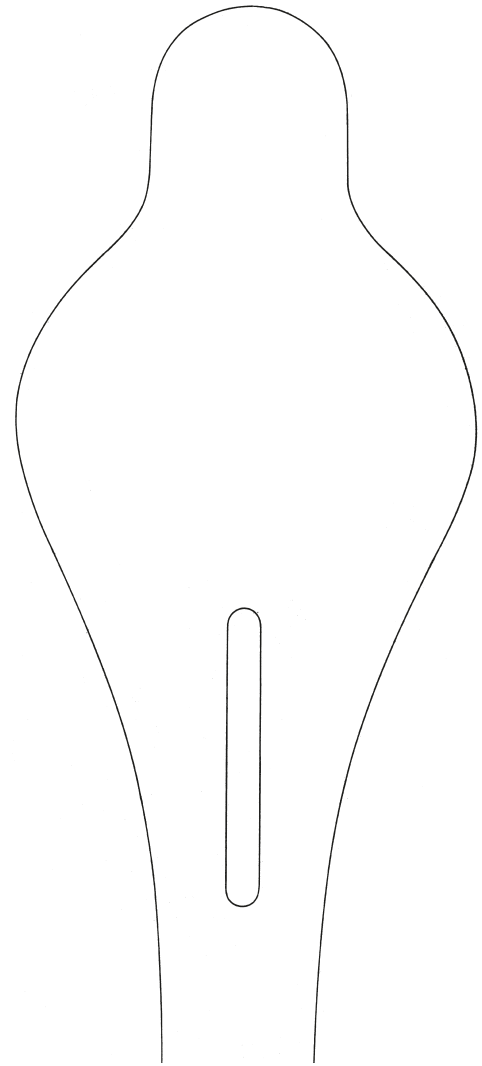
Elevadores para hueso

Leviers à os

Elevatori per ossa



**43 mm**  
23-559-24-01  
24 cm / 9 1/8"



**60 mm**  
23-561-24-01  
23,5 cm / 9 2/8"

1/2

Bennett  
23-559-24-01 -  
23-561-24-01



## Kniehaken, Spinalhaken

Knee Retractors, Spinal Retractors

Separadores para rodilla, Separadores espinales

Ecarteurs pour le genou, Ecarteurs spinaux

Divaricatori per il ginocchio, Divaricatori spinali

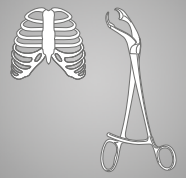
## Knochenchirurgie

Bone Surgery

Cirugía ósea

Chirurgie osseuse

Chirurgia ossea



1/3

**39 mm**  
Blount  
23-563-26-07

26,5 cm / 10 3/8"

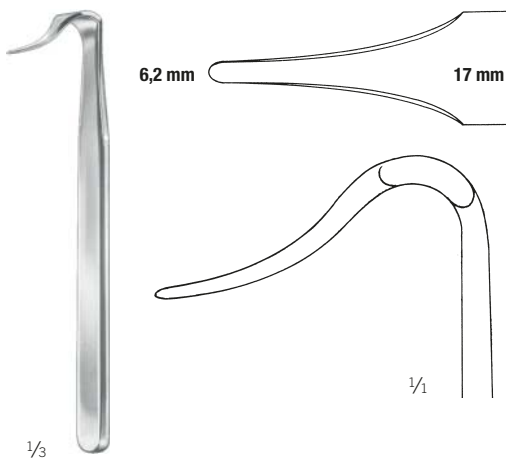
stumpf  
blunt  
romo  
mousse  
smusso



1/3

**47 mm**  
Blount  
23-565-26-07

26,5 cm / 10 3/8"



1/3

Blount  
23-567-17-07

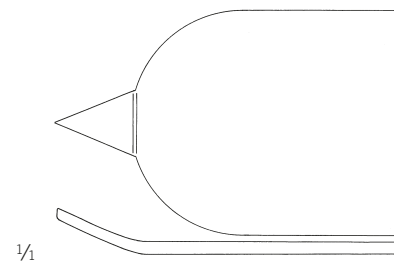
17,5 cm / 6 7/8"



1/3

Taylor  
23-571-16-07 -  
23-573-16-07

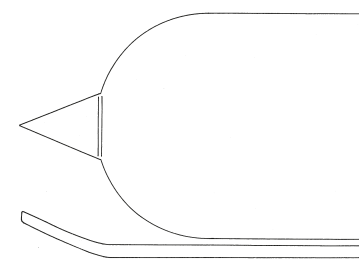
16 cm / 6 2/8"



1/1

**95 x 30 mm**  
23-571-16-07

16 cm / 6 2/8"



**115 x 30 mm**  
23-573-16-07

16 cm / 6 2/8"

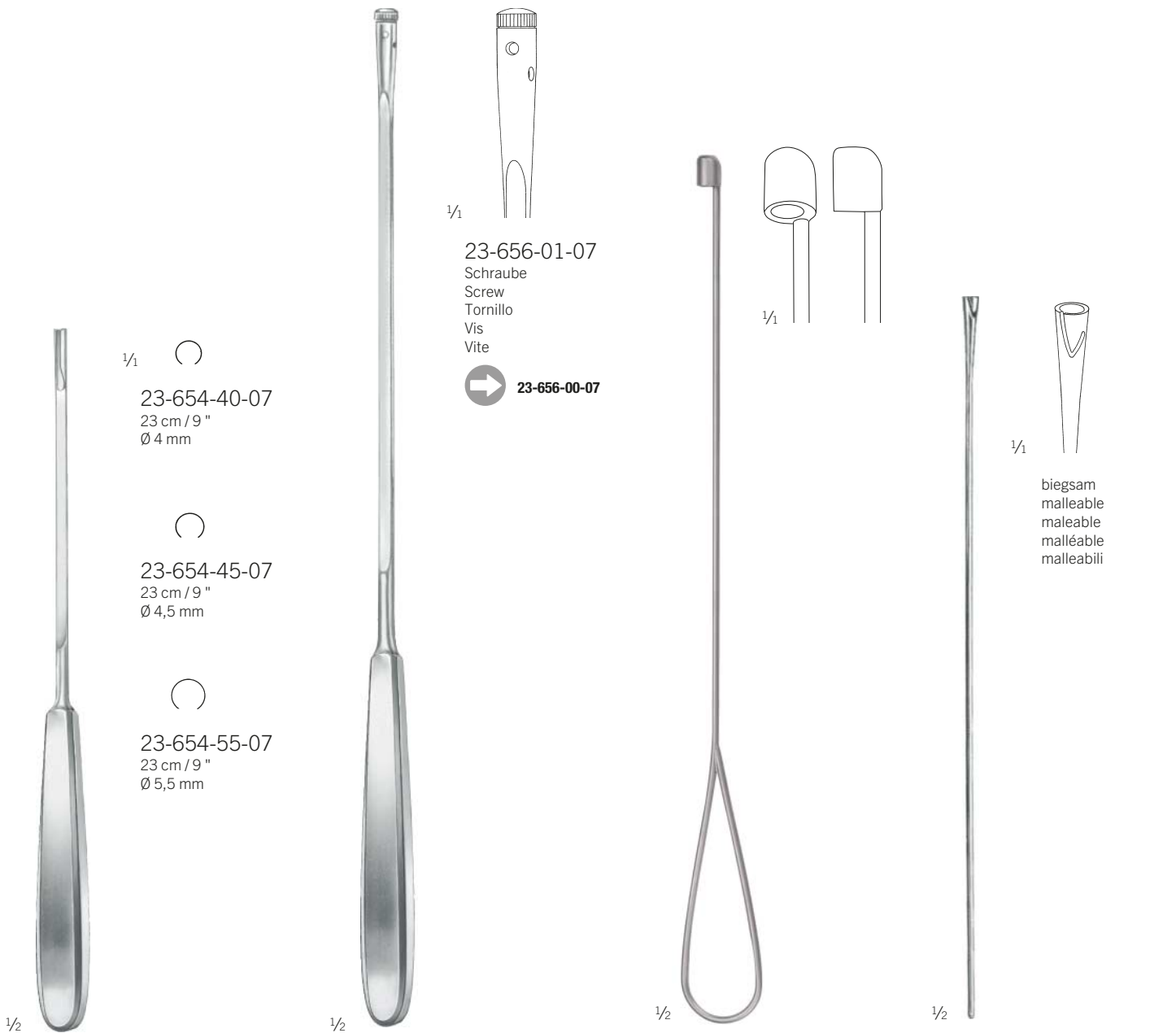
## Sehnenstripper

Tendon Strippers

Enucleadores de tendones

Instruments à écorcher les tendons

Scollatendini



23-654-40-07 -  
23-654-55-07

23 cm / 9 "

flexibler Schaft  
flexible shaft  
vástago flexible  
tige flexible  
gambo flessibile

23-656-00-07 -  
23-656-01-07

33,5 cm / 13 2/8 "

Sehndurchzuginstrument  
Tendon Passing Instrument  
Pasador de tendones  
Instrument pour passer les tendons  
Scollatendini

23-662-29-07

28,5 cm / 11 2/8 "

Bunnell

23-664-23-02

23 cm / 9 "

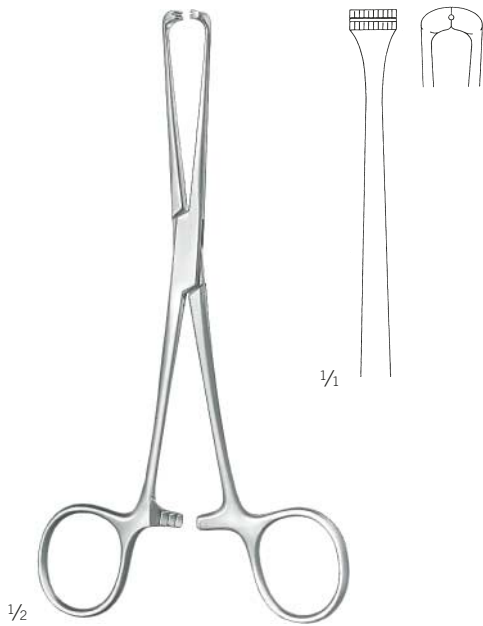
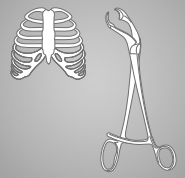
Sehndurchzugssonde  
Tendon Passer  
Sonda conductora de tendones  
Sonde conductrice pour tendons  
Sonda conduttrice per tendini

## Sehnenfazzangen, Sehnendurchzugzangen

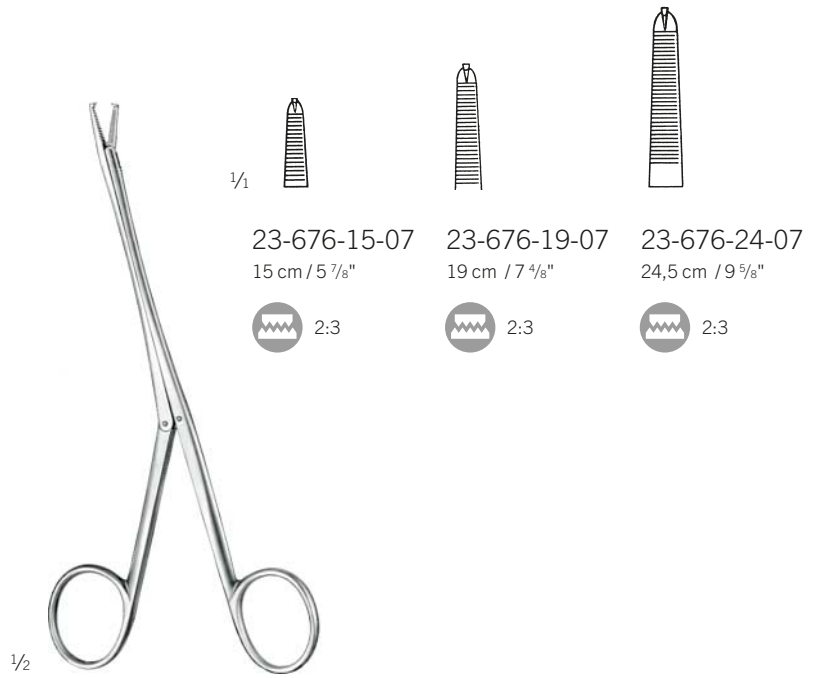
Tendon Holding Forceps, Tendon Tunnelling Forceps  
 Pinzas para coger tendones, Pinzas para pasar tendones  
 Pincas pour saisir les tendons, Pincas pour passer les tendons  
 Pinze per afferrare tendini, Pinze passa-tendini

## Knochenchirurgie

Bone Surgery  
 Cirugía ósea  
 Chirurgie osseuse  
 Chirurgia ossea



Steinmann  
 23-674-16-07  
 16 cm / 6 2/8"



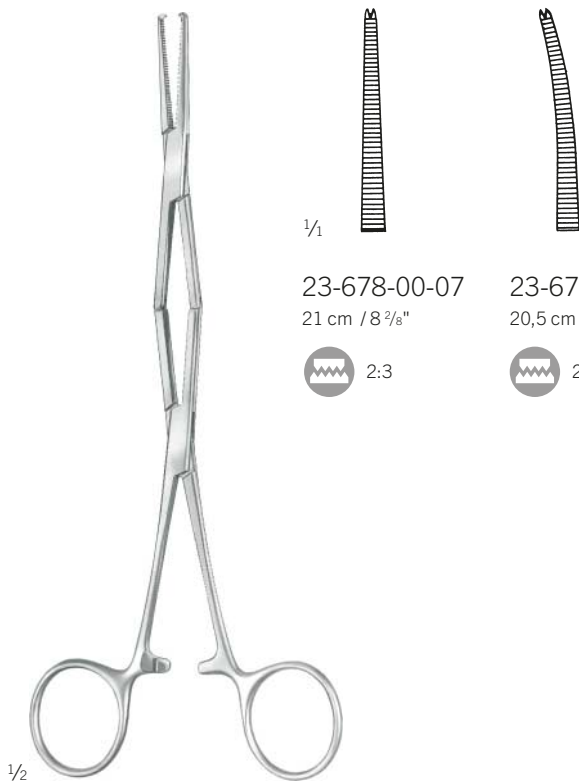
23-676-15-07  
 15 cm / 5 7/8"

23-676-19-07  
 19 cm / 7 4/8"

23-676-24-07  
 24,5 cm / 9 5/8"



Brand  
 23-676-15-07 -  
 23-676-24-07



23-678-00-07  
 21 cm / 8 2/8"

23-678-01-07  
 20,5 cm / 8 1/8"



23-678-00-07 -  
 23-678-01-07



Carroll  
 23-679-11-07  
 11,5 cm / 4 4/8"

## Sehnenfazzangen, Sehneinflechklemmen

Tendon Holding Forceps, Tendon Interlacing Forceps

Pinzas para coger tendones, Pinzas para entrelazar tendones

Pinces pour saisir les tendons, Pinces pour entrelacer les tendons

Pinze per afferrare tendini, Pinze per allacciare tendini



23-680-13-07  
11,5 cm / 4 5/8"

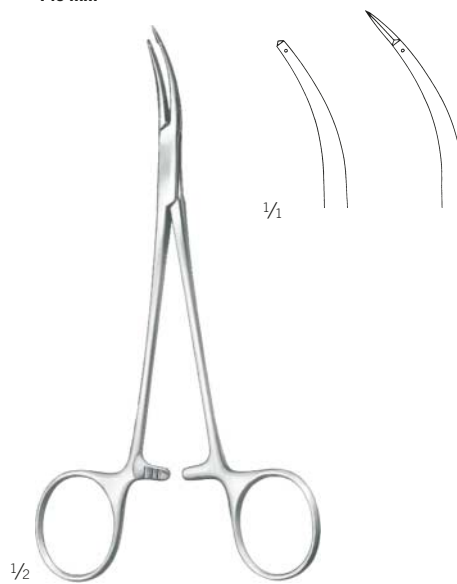


Kleinert-Kutz  
23-681-20-07  
21 cm / 8 3/8"

Schaftlänge  
shaft length  
longitud del vástago  
longueur de la tige  
lunghezza dell'asta  
**140 mm**



23-682-15-07  
15 cm / 5 7/8"



23-683-15-07  
15 cm / 5 7/8"

## Knorpelfasszangen, Knochenhaltezangen

Cartilage Seizing Forceps, Bone Holding Forceps

Pinzas para cartilago, Pinzas para hueso

Pinces à cartilage, Daviers porte-os

Pinze per cartilagine, Tenaglie per ossa

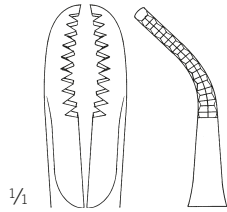
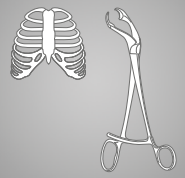
## Knochenchirurgie

Bone Surgery

Cirugía ósea

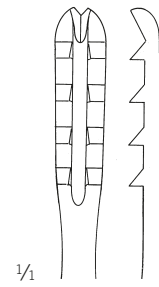
Chirurgie osseuse

Chirurgia ossea



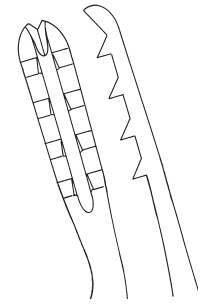
Knochenhaltezange  
Bone Holding Forceps  
Pinza para hueso  
Daviers porte-os  
Tenaglio per ossa

23-704-14-07  
14,5 cm / 5 7/8"

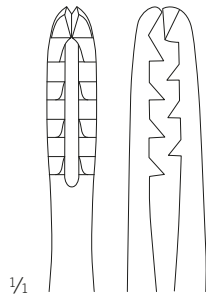
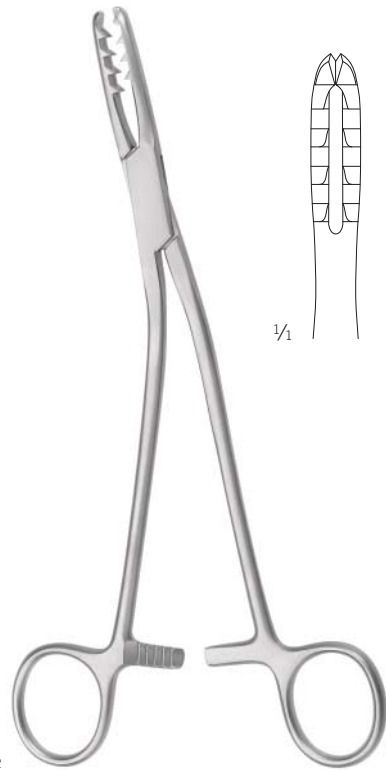


23-710-20-07  
21 cm / 8 3/8"  
gerade  
straight  
recta  
droite  
diritta

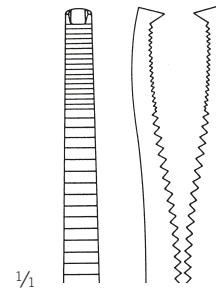
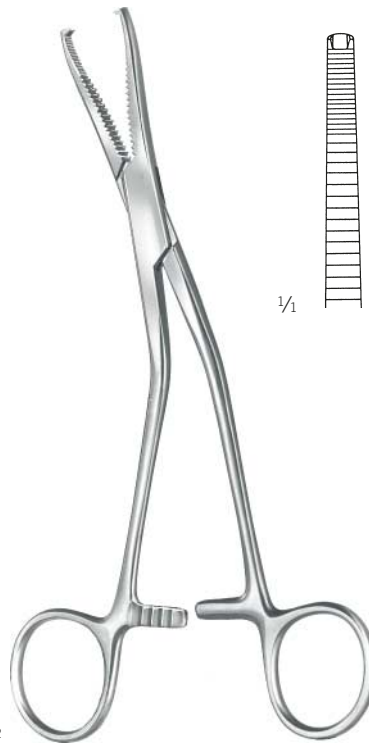
Bircher-Ganske  
23-710-20-07 -  
23-711-20-07



23-711-20-07  
20,5 cm / 8 1/8"  
aufgebogen  
curved upwards  
curva por arriba  
courbée en haut  
curva in alto



Bircher-Ganske  
23-713-20-07  
20 cm / 7 7/8"  
seitwärts gebogen  
curved sideways  
curva lateralmente  
courbée latéralement  
curva lateralmente



Dingmann  
23-715-19-07  
18,5 cm / 7 3/8"

## Knorpelfasszangen, Repositionszangen, Knochenhaltezangen

Cartilage Seizing Forceps, Reposition Forceps, Bone Holding Forceps

Pinzas para cartilago, Pinzas para reposición, Pinzas para hueso

Pinces à cartilage, Pinces à réduction, Daviers porte-os

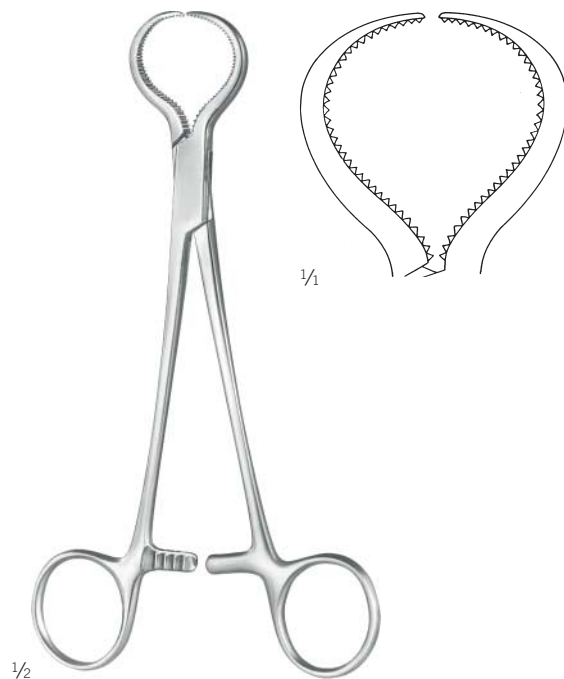
Pinze per cartillagine, Pinze per riposizioni, Tenaglie per ossa



Martin  
23-716-19-07  
18,5 cm / 7 2/8"



23-717-12-07  
13,5 cm / 5 3/8"  
lange Sperre  
long ratchet  
cremallera larga  
cremallière longue  
cremagliera lunga



Lewin  
23-718-17-07  
18 cm / 7 1/8"



23-720-14-07  
14 cm / 5 4/8"  
grazil  
delicate  
delicada  
gracile  
sottile



23-721-09-07  
9 cm / 3 4/8"  
lange Sperre  
long ratchet  
cremallera larga  
cremallière longue  
cremagliera lunga



23-721-14-07  
15 cm / 5 7/8"  
lange Sperre  
long ratchet  
cremallera larga  
cremallière longue  
cremagliera lunga

## Knochenhaltezangen

Bone Holding Forceps

Pinzas para hueso

Daviers porte-os

Tenaglie per ossa

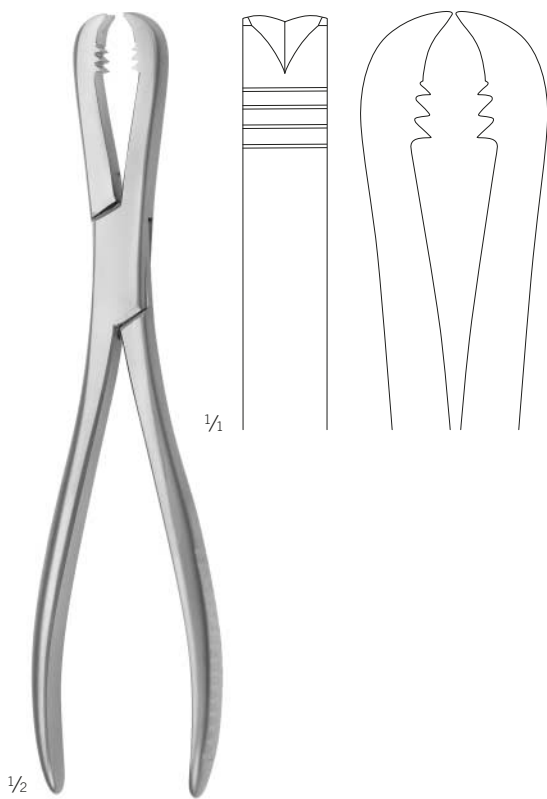
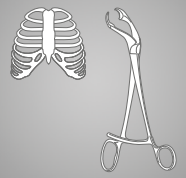
## Knochenchirurgie

Bone Surgery

Cirurgía ósea

Chirurgie osseuse

Chirurgia ossea



Langenbeck  
23-722-21-07  
21 cm / 8  $\frac{3}{8}$ "



Fergusson  
23-724-21-07  
21 cm / 8  $\frac{3}{8}$ "  
kräftiges Modell  
heavy pattern  
modelo fuerte  
modèle fort  
modello forte



Frosch  
23-726-18-07  
18 cm / 7  $\frac{1}{8}$ "

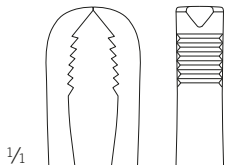
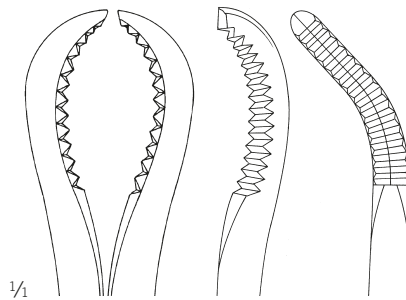
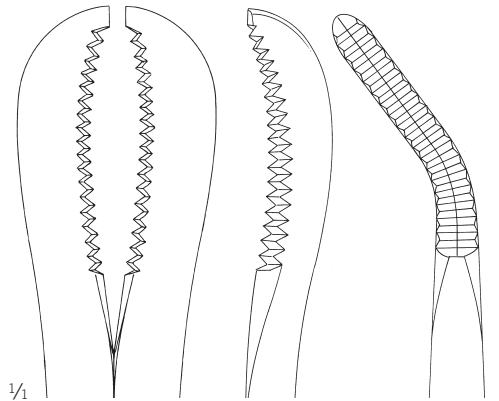
## Knochenhaltezaugen

Bone Holding Forceps

Pinzas para hueso

Daviers porte-os

Tenaglie per ossa



23-727-20-07  
20 cm / 7 7/8"



23-729-16-07  
17,5 cm / 6 7/8"  
mit Gewindesperre  
with thread fixation  
con cremallera de rosca  
avec cremallière fileté  
con cremagliera a filettatura



23-729-24-07  
24 cm / 9 4/8"  
mit Gewindesperre  
with thread fixation  
con cremallera de rosca  
avec cremallière fileté  
con cremagliera a filettatura



## Knochenhaltezangen, Repositionszangen

Bone Holding Forceps, Reposition Forceps

Pinzas para hueso, Pinzas para reposición

Daviers porte-os, Pincas à réduction

Tenaglie per ossa, Pinze per riposizioni

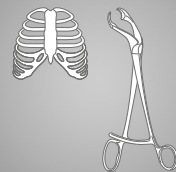
## Knochenchirurgie

Bone Surgery

Cirugía ósea

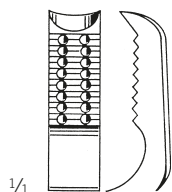
Chirurgie osseuse

Chirurgia ossea



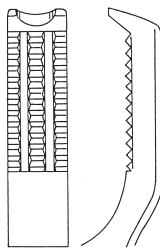
1/2

Kern  
23-730-17-07 -  
23-730-21-07



1/1

23-730-17-07  
17 cm / 6 5/8"

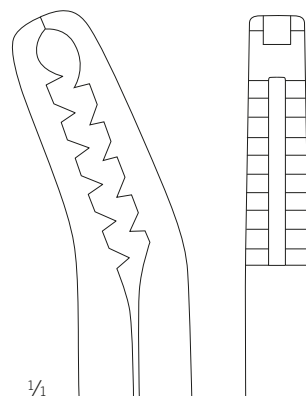


23-730-21-07  
24,5 cm / 9 5/8"



1/2

Semb  
23-731-19-07  
19,5 cm / 7 5/8"  
seitwärts gebogen  
curved sideways  
curva lateralmente  
courbée latéralement  
curva lateralmente



1/1

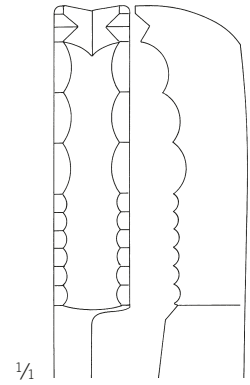
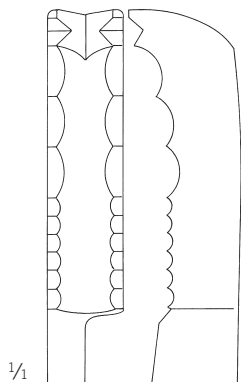
## Knochenhaltezaugen

Bone Holding Forceps

Pinzas para hueso

Daviers porte-os

Tenaglie per ossa



Farabeuf  
23-732-26-07  
26 cm / 10 <sup>2</sup>/<sub>8</sub>"

Farabeuf  
23-734-26-07  
26 cm / 10 <sup>2</sup>/<sub>8</sub>"

# Knochenhaltezangen

Bone Holding Forceps

Pinzas para hueso

Daviers porte-os

Tenaglie per ossa

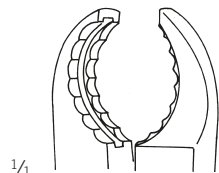
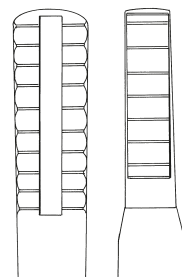
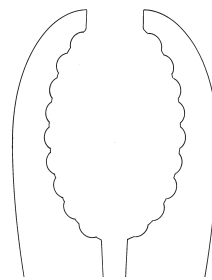
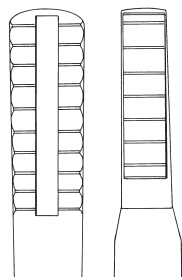
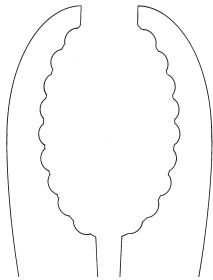
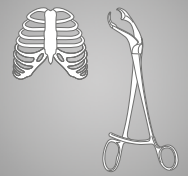
# Knochenchirurgie

Bone Surgery

Cirugía ósea

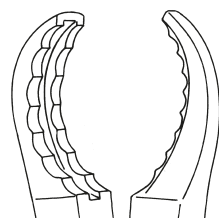
Chirurgie osseuse

Chirurgia ossea

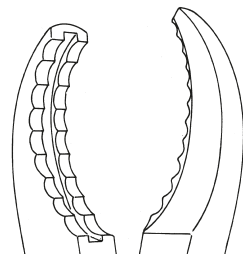


1/1

23-746-23-07  
23 cm / 9"



23-746-25-07  
25 cm / 9 7/8"

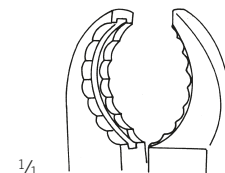


23-746-28-07  
28 cm / 11"

1/2

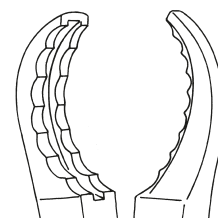
Ulrich  
23-746-23-07 -  
23-746-28-07

mit Gewindesperre  
with thread fixation  
con cremallera de rosca  
avec cremallière fileté  
con cremagliera a filettatura

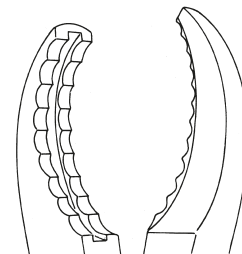


1/1

23-747-23-07  
23 cm / 9"



23-747-25-07  
25 cm / 9 7/8"



23-747-28-07  
27 cm / 10 5/8"

1/2

Ulrich  
23-747-23-07 -  
23-747-28-07

mit Gewindesperre  
with thread fixation  
con cremallera de rosca  
avec cremallière fileté  
con cremagliera a filettatura

23

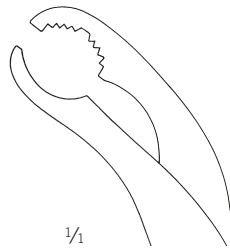
## Knochenhaltezaugen

Bone Holding Forceps

Pinzas para hueso

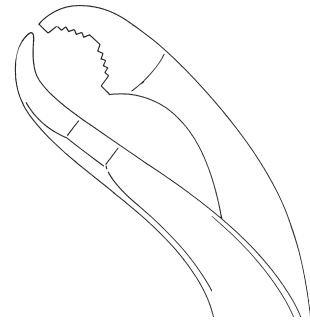
Daviers porte-os

Tenaglie per ossa

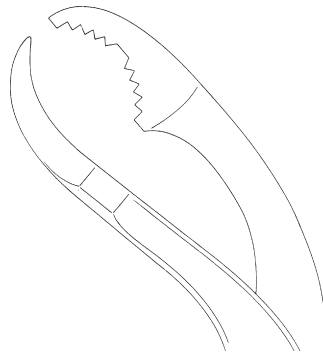


1/1

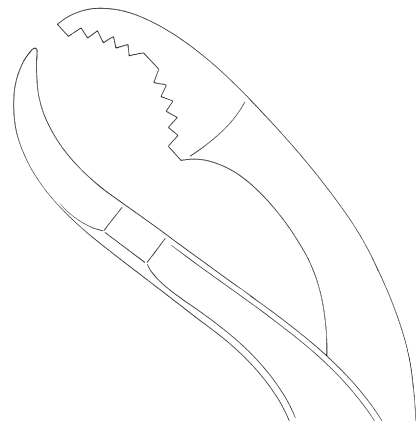
23-749-15-07  
15 cm / 5 7/8"



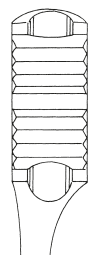
23-749-19-07  
20 cm / 7 7/8"



23-749-24-07  
24 cm / 9 4/8"



23-749-26-07  
26 cm / 10 2/8"

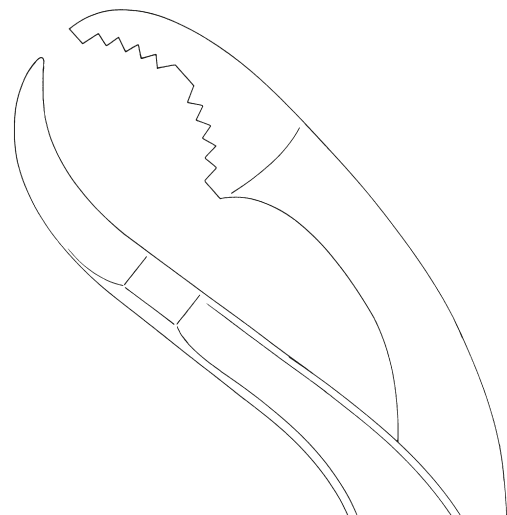


23-749-90-98

Rändelmutter  
Knurled nut  
Tuerca moleteada  
Ecrou moleté  
Madrevite zigrinata



23-749-15-07 -  
23-749-28-07



23-749-28-07  
28 cm / 11 "

1/2

23-749-15-07 -  
23-749-90-98

selbstzentrierend, mit Gewindeperr  
self-centering, with thread fixation  
autocentrante, con cremallera de rosca  
à centrage automatique, avec cremallière filettée  
centraggio automatico, con cremagliera a filettatura

## Knochenhaltezangen

Bone Holding Forceps

Pinzas para hueso

Daviers porte-os

Tenaglie per ossa

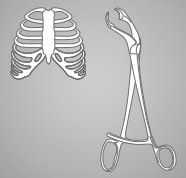
## Knochenchirurgie

Bone Surgery

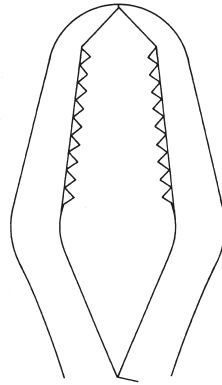
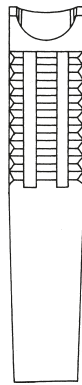
Cirurgía ósea

Chirurgie osseuse

Chirurgia ossea

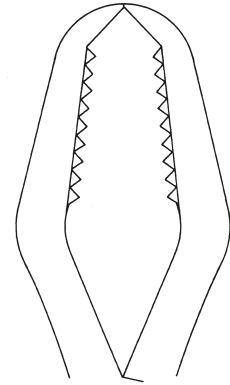
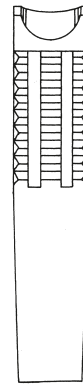


1/4



23-750-33-07

ohne Sperre  
without ratchet  
sin cremallera  
sans cremallière  
senza cremagliera



23-752-33-07

mit Sperre  
with ratchet  
con cremallera  
avec cremallière  
con cremagliera

1/2

Lane  
23-750-33-07 -  
23-752-33-07  
33 cm / 13 "

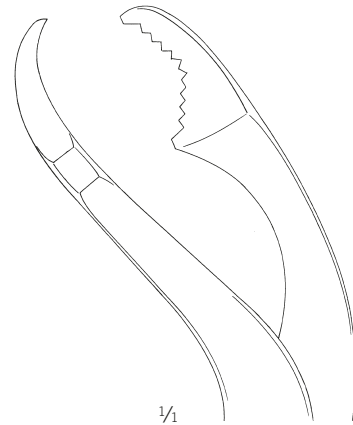
## Knochenhaltezangen

Bone Holding Forceps

Pinzas para hueso

Daviers porte-os

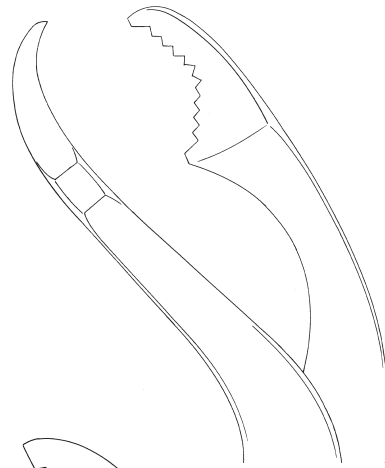
Tenaglie per ossa



1/1

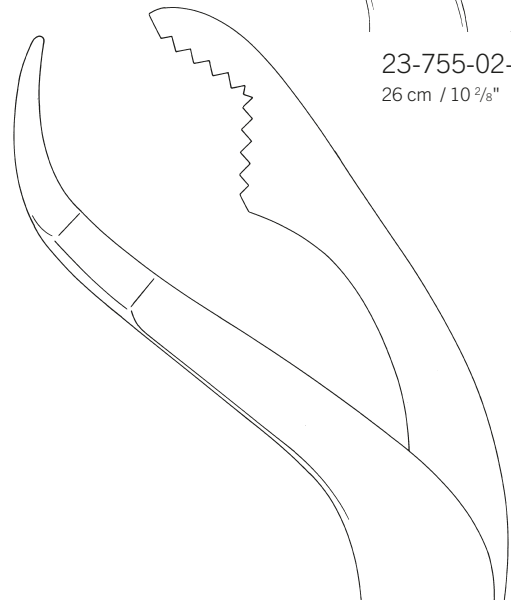
23-755-01-07

25 cm / 9 7/8"



23-755-02-07

26 cm / 10 2/8"



23-755-03-07

27,5 cm / 10 7/8"



1/1

1/2

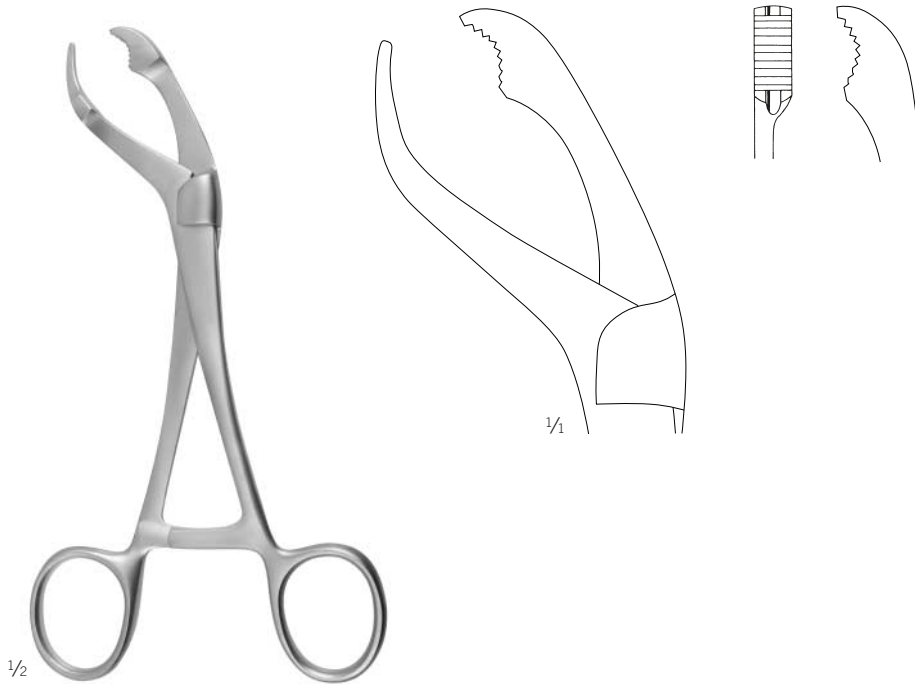
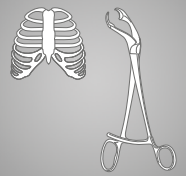
Verbrugge  
23-755-01-07 -  
23-755-03-07

## Knochenhaltezangen, Amputationsschild

Bone Holding Forceps, Amputation Retractor  
Pinzas para hueso, Retractor para amputación  
Daviers porte-os, Retracteur pour amputation  
Tenaglie per ossa, Retrattore per amputazione

## Knochenchirurgie

Bone Surgery  
Cirugía ósea  
Chirurgie osseuse  
Chirurgia ossea



Verbrugge  
23-757-01-07  
17,5 cm / 6 7/8"



Percy  
23-762-30-07  
auseinandernehmbar  
detachable  
desmontable  
démontable  
smontabile

# Hohlmeißelzangen

Bone Rongeurs

Pinzas gubias

Pinces-gouges

Pinze-sgorbie

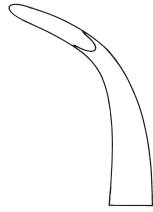


1/2



1/4

23-777-01-07  
17 cm / 6 5/8"



23-777-02-07  
16,5 cm / 6 1/2"



1/2



1/4

Friedmann  
23-799-12-07  
12,5 cm / 4 7/8"

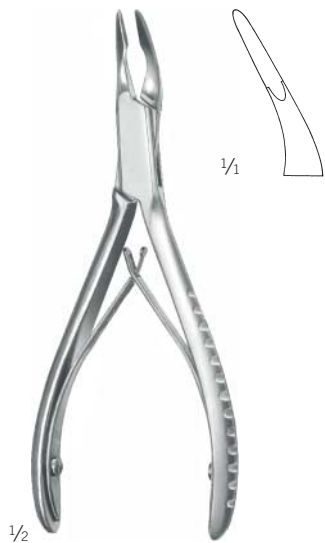


1/2

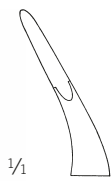


1/4

Friedmann  
23-801-14-07  
13,5 cm / 5 3/8"

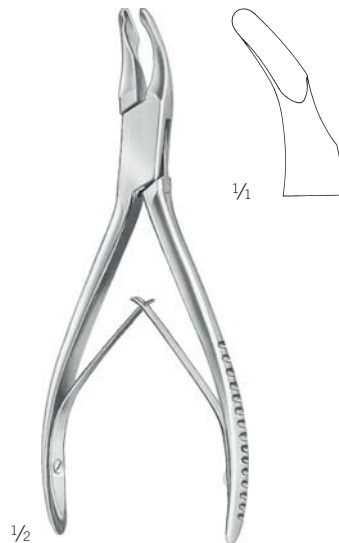


1/2



1/4

Friedmann  
23-803-14-07  
13,5 cm / 5 3/8"



1/2



1/4

Cleveland  
23-805-14-07  
13,5 cm / 5 3/8"



1/2



1/4

Cleveland  
23-807-17-07  
16,5 cm / 6 1/2"

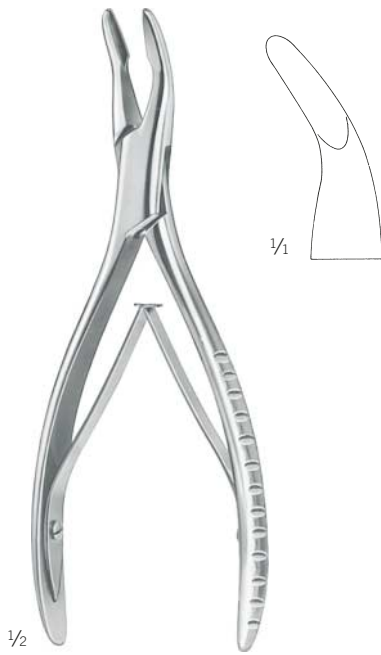
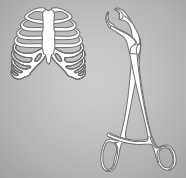


## Hohlmeißelzangen

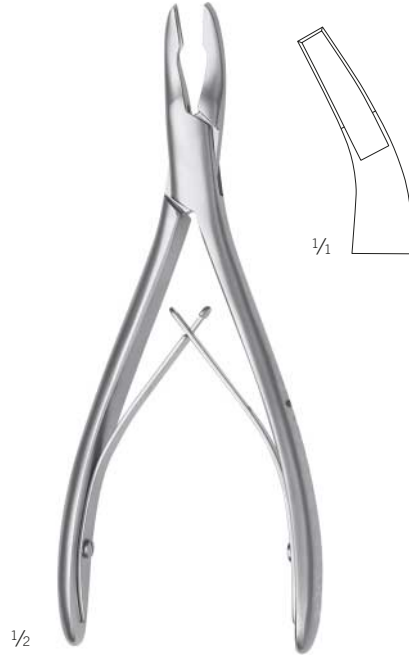
Bone Rongeurs  
Pinzas gubias  
Pinces-gouges  
Pinze-sgorbie

## Knochenchirurgie

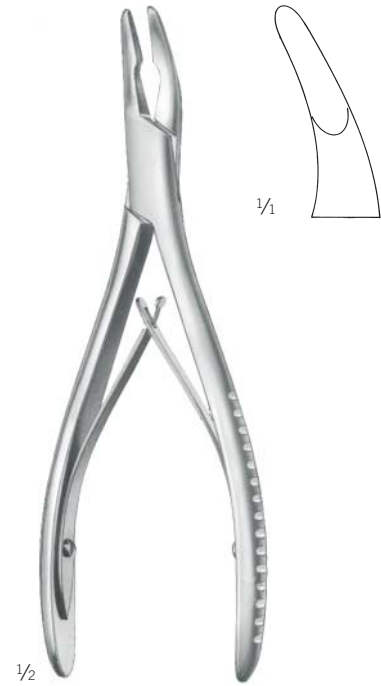
Bone Surgery  
Cirugía ósea  
Chirurgie osseuse  
Chirurgia ossea



Mead  
23-815-16-07  
16,5 cm / 6 5/8"



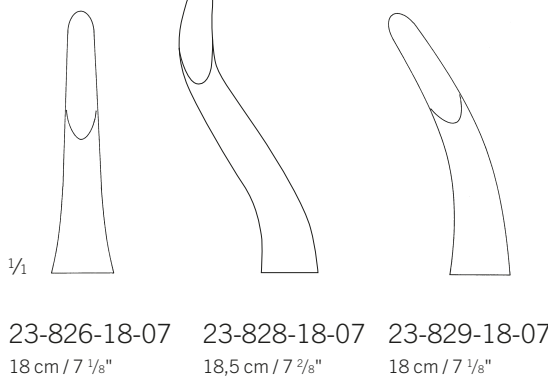
Mead  
23-816-16-07  
16,5 cm / 6 5/8"



Hartmann  
23-819-18-07  
17,5 cm / 6 7/8"



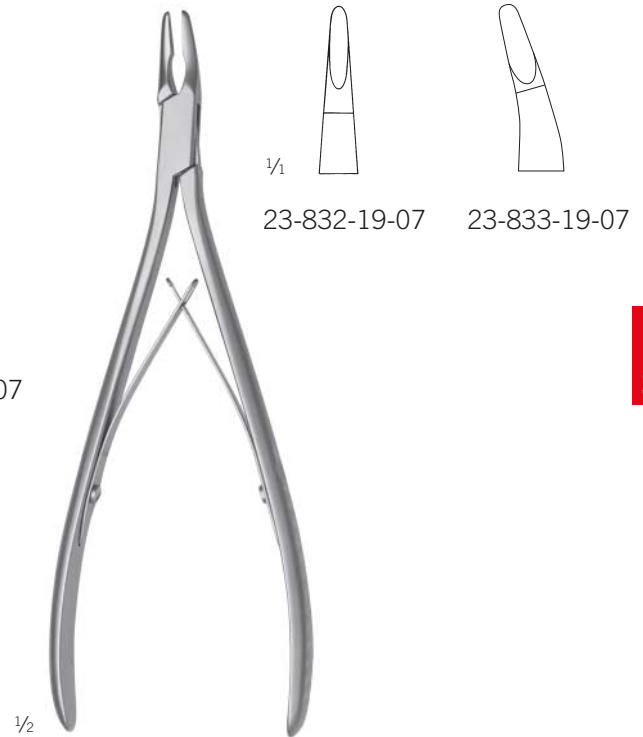
Jansen  
23-826-18-07 -  
23-829-18-07



23-826-18-07  
18 cm / 7 1/8"

23-828-18-07  
18,5 cm / 7 3/8"

23-829-18-07  
18 cm / 7 1/8"



Lempert  
23-832-19-07 -  
23-833-19-07  
19 cm / 7 4/8"

## Hohlmeißelzangen

Bone Rongeurs

Pinzas gubias

Pinces-gouges

Pinze-sgorbie

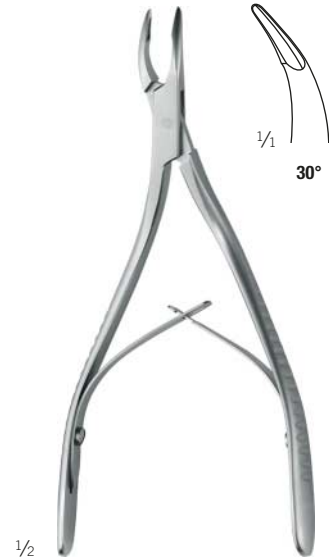


1/2

23-835-15-07  
16 cm / 6 2/8"



23-837-15-07  
15,5 cm / 6 1/8"



1/2

30°

1/2

Blumenthal  
23-835-15-07 -  
23-837-15-07

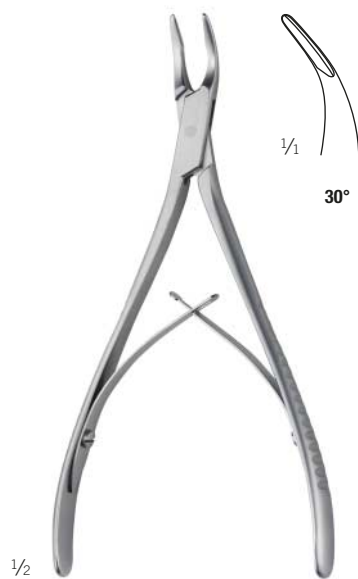
23-835-30-07  
15,5 cm / 6 1/8"  
S-Form  
S-shape  
forma S  
courbé en S  
curvo in forma S



1/2

1/2

23-836-00-07  
15,5 cm / 6 1/8"



1/2

30°

1/2

23-836-30-07  
15,5 cm / 6 1/8"



1/2

90°

1/2

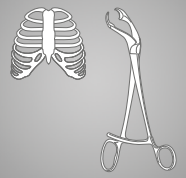
23-836-90-07  
14,5 cm / 5 6/8"

## Hohlmeißelzangen

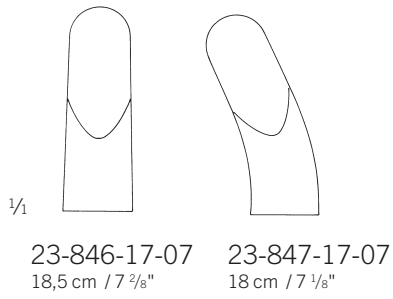
Bone Rongeurs  
Pinzas gubias  
Pinces-gouges  
Pinze-sgorbie

## Knochenchirurgie

Bone Surgery  
Cirugía ósea  
Chirurgie osseuse  
Chirurgia ossea



1/2



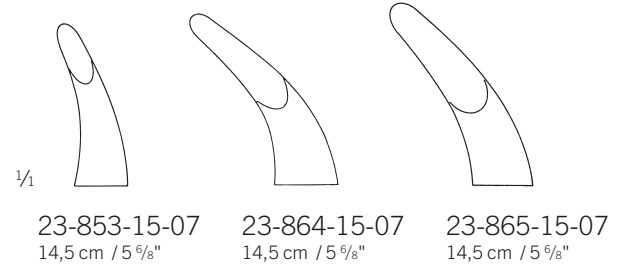
1/1

23-846-17-07  
18,5 cm / 7 3/8"

23-847-17-07  
18 cm / 7 1/8"



1/2



1/1

23-853-15-07  
14,5 cm / 5 6/8"

23-864-15-07  
14,5 cm / 5 5/8"

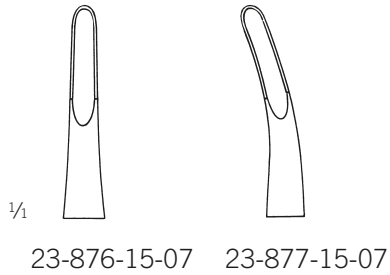
23-865-15-07  
14,5 cm / 5 5/8"

Luer  
23-846-17-07 -  
23-847-17-07

Luer  
23-853-15-07 -  
23-865-15-07



1/2



1/1

23-876-15-07

23-877-15-07

Böhler  
23-876-15-07 -  
23-877-15-07  
15 cm / 5 7/8"



1/2

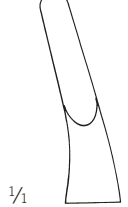


1/1

Beyer  
23-879-18-07  
18 cm / 7 1/8"



1/2



1/1

Zaufal-Jansen  
23-881-18-07  
18 cm / 7 1/8"

# Hohlmeißelzangen

Bone Rongeurs

Pinzas gubias

Pinces-gouges

Pinze-sgorbie



Mayfield  
23-883-17-07  
18 cm / 7 1/8"



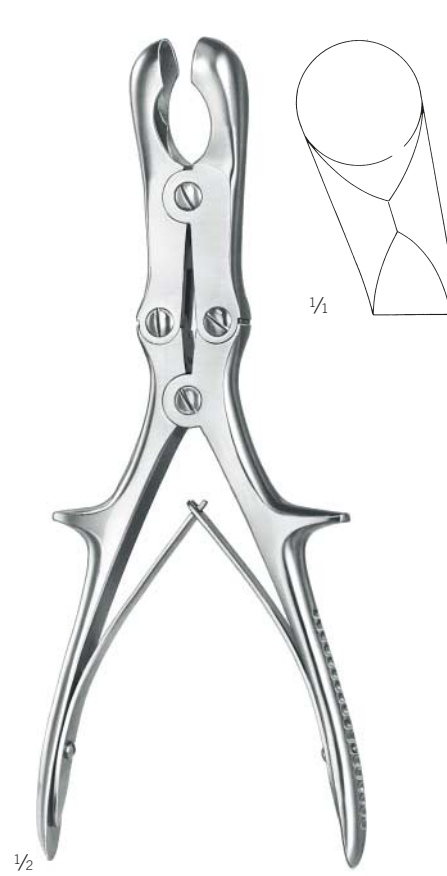
Marquard  
23-885-20-07  
20,5 cm / 8 1/8"



Ruskin  
23-887-18-07  
19 cm / 7 1/8"



Ruskin  
23-893-23-07  
24 cm / 9 4/8"



Semb  
23-895-22-07  
23,5 cm / 9 2/8"



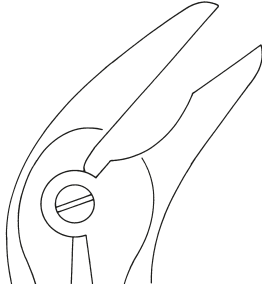
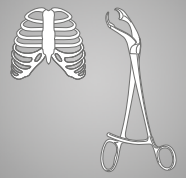
Stille  
23-897-23-07  
22,5 cm / 8 7/8"

## Hohlmeißelzangen

Bone Rongeurs  
Pinzas gubias  
Pinces-gouges  
Pinze-sgorbie

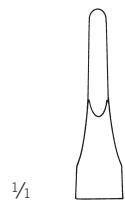
## Knochenchirurgie

Bone Surgery  
Cirugía ósea  
Chirurgie osseuse  
Chirurgia ossea



1/2

Echlin  
23-899-02-07 -  
23-899-04-07  
23 cm / 9 "



1/1

23-899-02-07



23-899-03-07



23-899-04-07



1/2

Stille-Ruskin  
23-901-23-07  
23,5 cm / 9 3/8 "



1/1

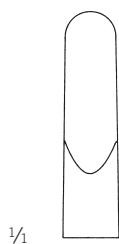
## Hohlmeißelzangen

Bone Rongeurs

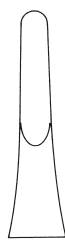
Pinzas gubias

Pinces-gouges

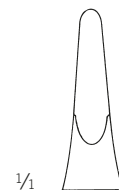
Pinze-sgorbie



23-905-24-07



23-907-24-07



Frykholm  
23-909-24-07  
24,5 cm / 9 5/8"

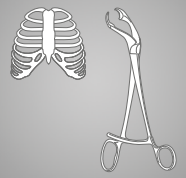
Leksell-Stille  
23-905-24-07 -  
23-907-24-07  
24,5 cm / 9 5/8"

## Hohlmeißelzangen

Bone Rongeurs  
Pinzas gubias  
Pincés-gouges  
Pinze-sgorbie

## Knochenchirurgie

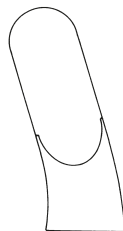
Bone Surgery  
Cirugía ósea  
Chirurgie osseuse  
Chirurgia ossea



1/4



23-910-22-07



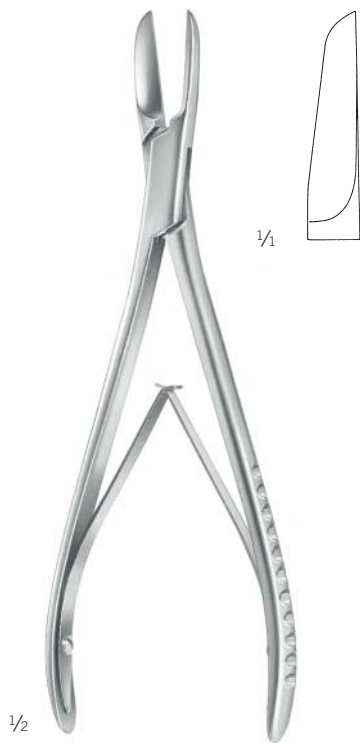
23-911-22-07

1/2

Stille-Luer  
23-910-22-07 -  
23-911-22-07  
22,5 cm / 8 7/8"

## Knochensplitterzangen

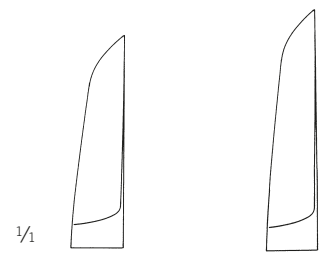
Bone Cutting Forceps  
Pinzas cortantes para hueso  
Pincers coupantes à os  
Cesoie per ossa



Cottle-Kazanjan  
23-930-19-07  
19 cm / 7 4/8"

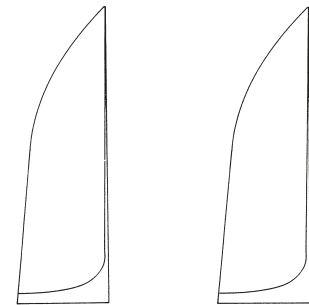


Liston  
23-934-14-07 -  
23-934-22-07



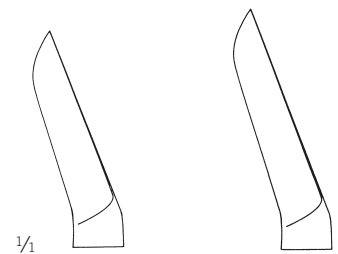
23-934-14-07  
14 cm / 5 4/8"

23-934-17-07  
17 cm / 6 5/8"



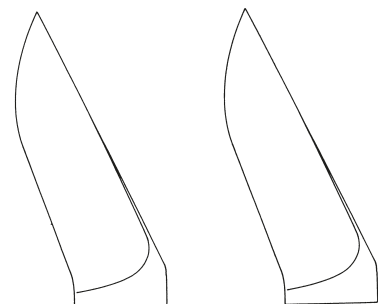
23-934-19-07  
20 cm / 7 7/8"

23-934-22-07  
22 cm / 8 5/8"



23-935-14-07  
14 cm / 5 4/8"

23-935-17-07  
17 cm / 6 5/8"



23-935-19-07  
20 cm / 7 7/8"

23-935-22-07  
22 cm / 8 5/8"



Liston  
23-935-14-07 -  
23-935-22-07

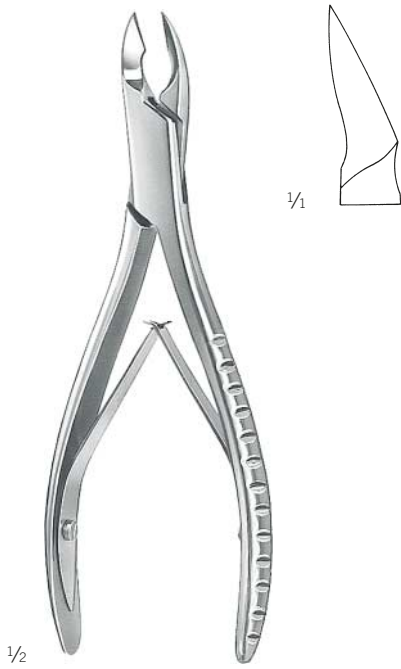
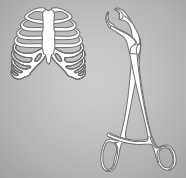


## Knochensplitterzangen

Bone Cutting Forceps  
Pinzas cortantes para hueso  
Pincès coupantes à os  
Cesoie per ossa

## Knochenchirurgie

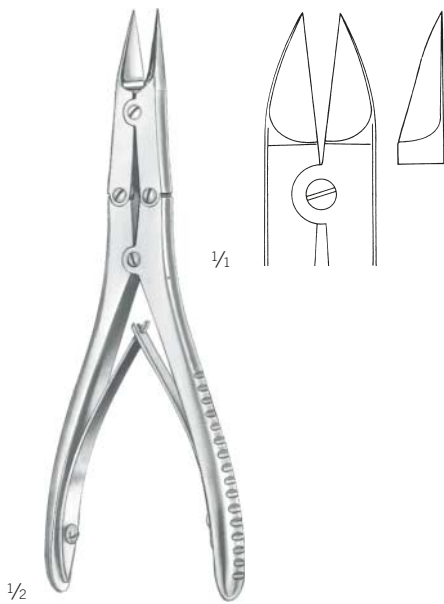
Bone Surgery  
Cirugía ósea  
Chirurgie osseuse  
Chirurgia ossea



Cleveland  
23-939-17-07  
17 cm / 6 5/8"



Cleveland  
23-941-15-07  
14,5 cm / 5 7/8"



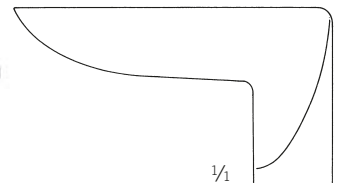
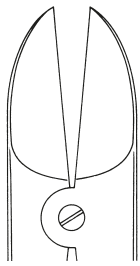
Böhler  
23-944-15-07  
14,5 cm / 5 7/8"



Böhler  
23-946-15-07  
14,5 cm / 5 7/8"

## Knochensplitterzangen

Bone Cutting Forceps  
Pinzas cortantes para hueso  
Pincès coupantes à os  
Cesoie per ossa



1/1

23-950-18-07  
19 cm / 7 1/8"



23-951-18-07  
18,5 cm / 7 3/8"



1/2

Stille-Liston  
23-952-27-07  
26 cm / 10 2/8"

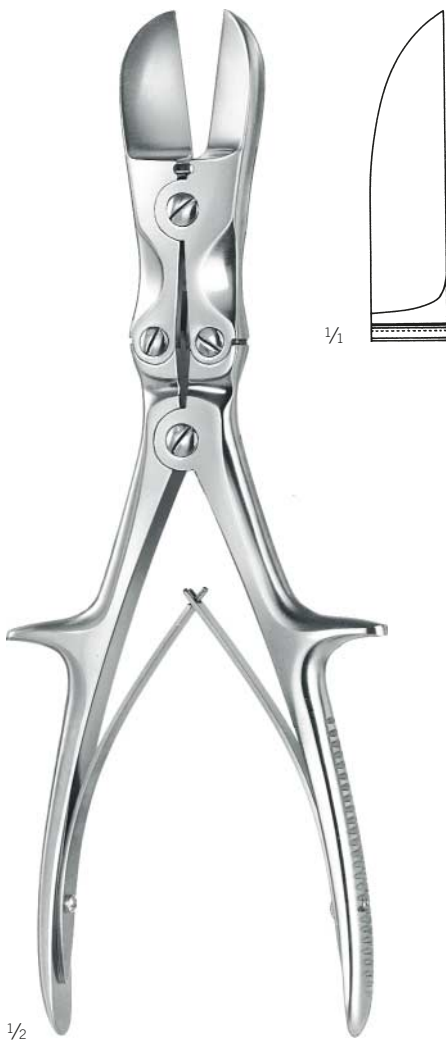
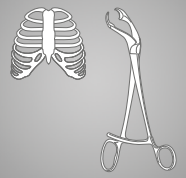
Ruskin-Liston  
23-950-18-07 -  
23-951-18-07

## Knochensplitterzangen

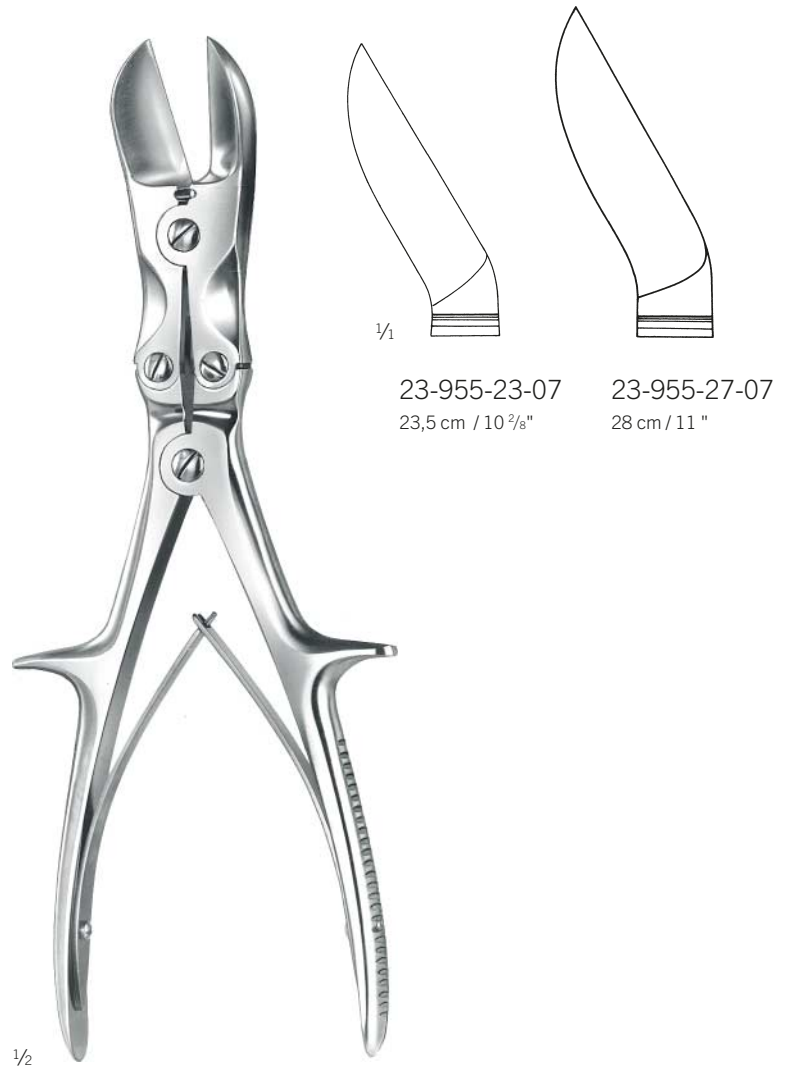
Bone Cutting Forceps  
Pinzas cortantes para hueso  
Pincas coupantes à os  
Cesoie per ossa

## Knochenchirurgie

Bone Surgery  
Cirugía ósea  
Chirurgie osseuse  
Chirurgia ossea



Stille-Liston  
23-954-27-07  
28 cm / 11 "



Stille-Liston  
23-955-23-07 -  
23-955-27-07

## Knochensplitterzangen

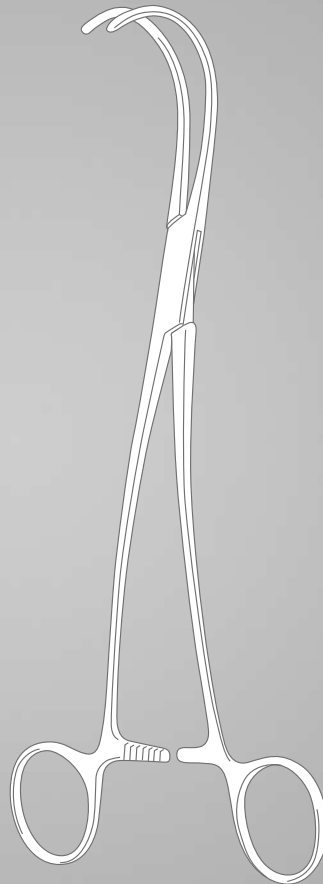
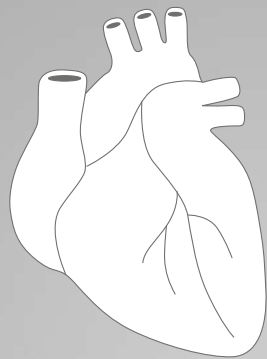
Bone Cutting Forceps  
Pinzas cortantes para hueso  
Pinces coupantes à os  
Cesoie per ossa



Liston-Key  
23-957-27-07  
26 cm / 10 <sup>3</sup>/<sub>8</sub>"

Herz-, Thorax- und Gefäßchirurgie  
Cardio Thoracic and Vascular Surgery  
Cirugía cardíaca, torácica y vascular  
Chirurgie cardiaque, thoracique et vasculaire  
Chirurgia cardiaca, toracica e vascolare

# 24



## Spezial-Produkte

Special Products

Productos especiales

Produits spéciaux

Prodotti speciali

Unser Katalog „Herz-, Thorax- und Gefäßchirurgie“ enthält die gesamte Palette der KLS-Martin-Instrumente für die Herz-Thorax- und Gefäßchirurgie.

Our catalog “Cardio Thoracic and Vascular Surgery” contains the full range of KLS Martin instruments for cardio thoracic and vascular surgery.

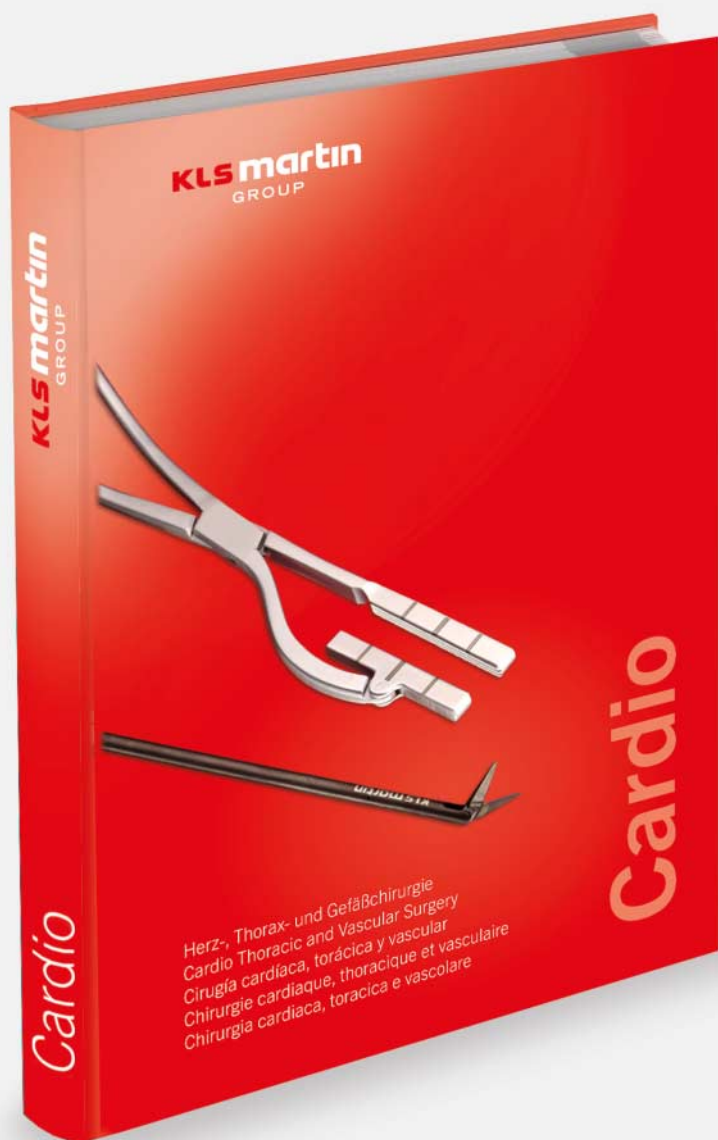
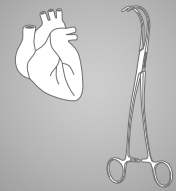
Nuestro catálogo “Cirugía cardíaca, torácica y vascular” incluye la gama completa de instrumentos por la cirugía cardíaca, torácica y vascular de KLS Martin.

Notre catalogue « Chirurgie cardiaque, thoracique et vasculaire » contient l'ensemble de la palette des instruments pour la chirurgie cardiaque, thoracique et vasculaire de KLS Martin.

Il nostro catalogo “Chirurgia cardiaca, toracica e vascolare” contiene la gamma completa degli strumenti per la chirurgia cardiaca, toracica e vascolare di KLS Martin.

**Herz-, Thorax- und Gefäßchirurgie**

Cardio Thoracic and Vascular Surgery  
Cirugía cardíaca, torácica y vascular  
Chirurgie cardiaque, thoracique et vasculaire  
Chirurgia cardiaca, toracica e vascolare

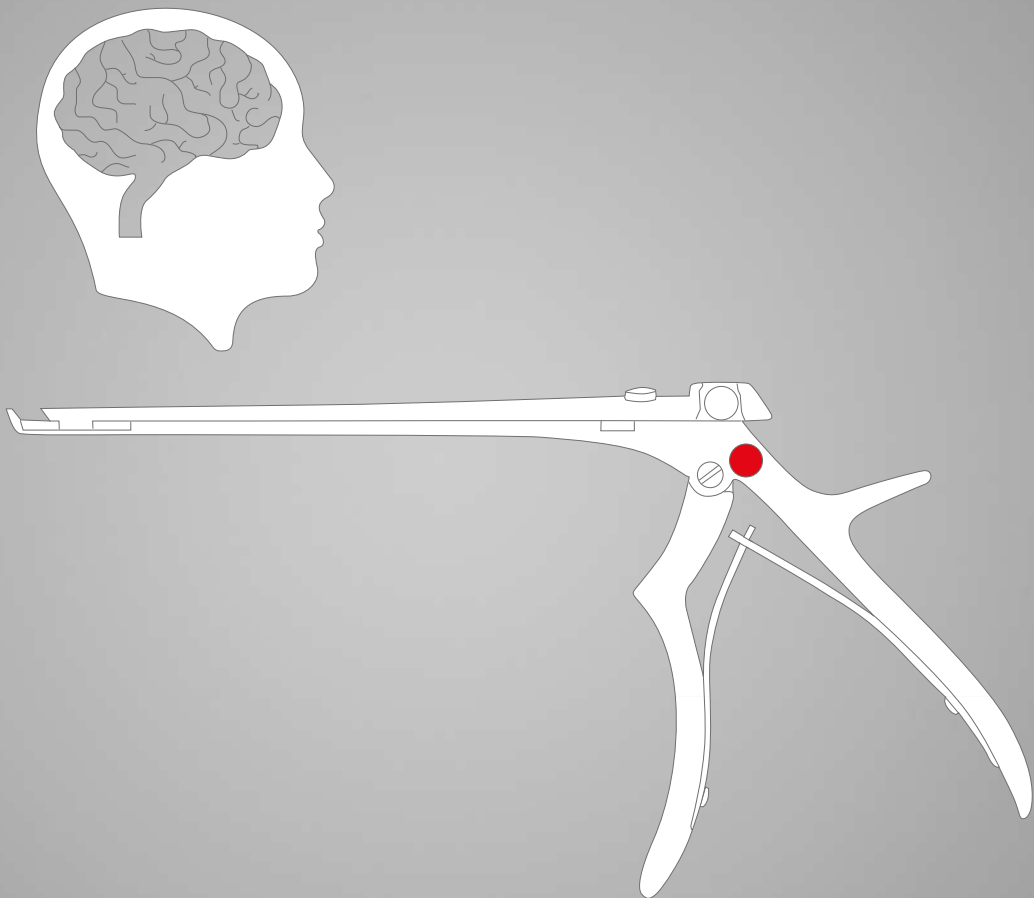






Neurochirurgie  
Neurosurgery  
Neurocirugía  
Neurochirurgie  
Neurochirurgia

# 24



## Spezial-Produkte

Special Products

Productos especiales

Produits spéciaux

Prodotti speciali

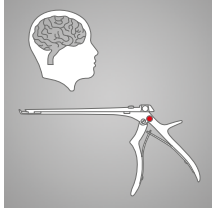
Unser Katalog „Neurochirurgie“ enthält die gesamte Palette der KLS-Martin-Neuro-Instrumente.

Our catalog “Neurosurgery” contains the full range of KLS Martin neurosurgical instruments.

Nuestro catálogo “Neurocirugía” incluye la gama completa de instrumentos de KLS Martin para neurocirugía.

Notre catalogue « Neurochirurgie » contient l’ensemble de la palette des instruments de neurochirurgie KLS Martin.

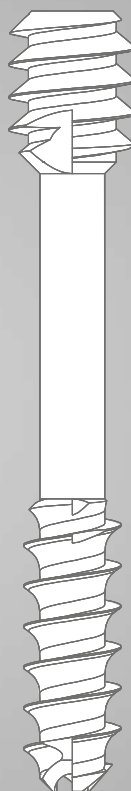
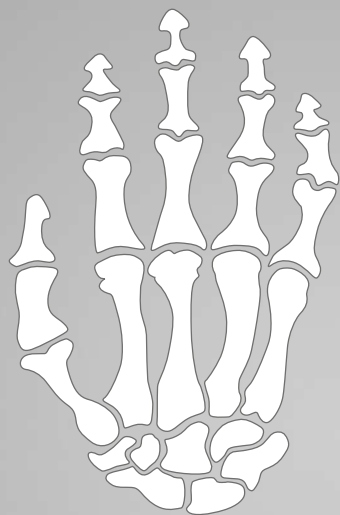
Il nostro catalogo “Neurochirurgia” contiene la gamma completa degli strumenti per la neurochirurgia di KLS Martin.





Implantat-Systeme CMF und Trauma  
Implant Systems CMF and Trauma  
Sistemas de implantes CMF y Trauma  
Systèmes d'implant CMF et Trauma  
Sistemi di impianto CMF e Trauma

# 25-26



## Spezial-Produkte

Special Products  
Productos especiales  
Produits spéciaux  
Prodotti speciali

Unser Ordner-System „Hand Surgery“ enthält die gesamte Palette der KLS-Martin-Implantate und -Instrumente für die Handchirurgie.

Our folder system “Hand Surgery” contains the full range of KLS-Martin implants and instruments for hand surgery.

Nuestro sistema de carpetas “Hand Surgery” incluye la gama completa de implantes e instrumentos de KLS-Martin para la cirugía de la mano.

Notre système de dossiers «Hand Surgery» contient l'ensemble de la palette des implants et instruments KLS Martin pour la chirurgie de la main.

Il nostro sistema di cartelle “Hand Surgery” contiene la gamma completa degli impianti e degli strumenti di KLS Martin per la chirurgia della mano.

Unser Katalog „Produktübersicht Traumatologie“ enthält die gesamte Palette der KLS-Martin-Instrumente für die Knochenchirurgie.

Our catalog “Traumatology Product Overview” contains the full range of KLS-Martin implants and instruments for bone surgery.

Nuestro catálogo “Traumatology Product Overview” incluye la gama completa de los implantes e instrumentos de KLS-Martin para la cirugía ósea.

Notre catalogue «Traumatology Product Overview» contient l'ensemble de la palette des implants et instruments KLS Martin pour la chirurgie osseuse

Il nostro catalogo “Traumatology Product Overview” contiene la gamma completa degli impianti e degli strumenti di KLS Martin per la chirurgia ossea

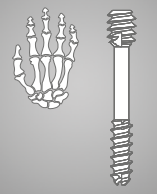
Unser Ordner-System „CMF Osteosynthesis“ enthält die gesamte Palette der KLS-Martin-Implantate und -Instrumente für die Mund-, Kiefer- und Gesichtschirurgie.

Our folder system “CMF Osteosynthesis” contains the full range of KLS-Martin implants and instruments for cranio-maxillofacial surgery.

Nuestro sistema de carpetas “CMF Osteosynthesis” incluye la gama completa de implantes e instrumentos de KLS-Martin para la cirugía oral y maxilofacial.

Notre système de dossiers «CMF Osteosynthesis» contient l'ensemble de la palette des implants et instruments KLS Martin pour la chirurgie buccale et maxillofaciale.

Il nostro sistema di cartelle “CMF Osteosynthesis” contiene la gamma completa degli impianti e degli strumenti di KLS Martin per la chirurgia orale-maxillo-facciale.

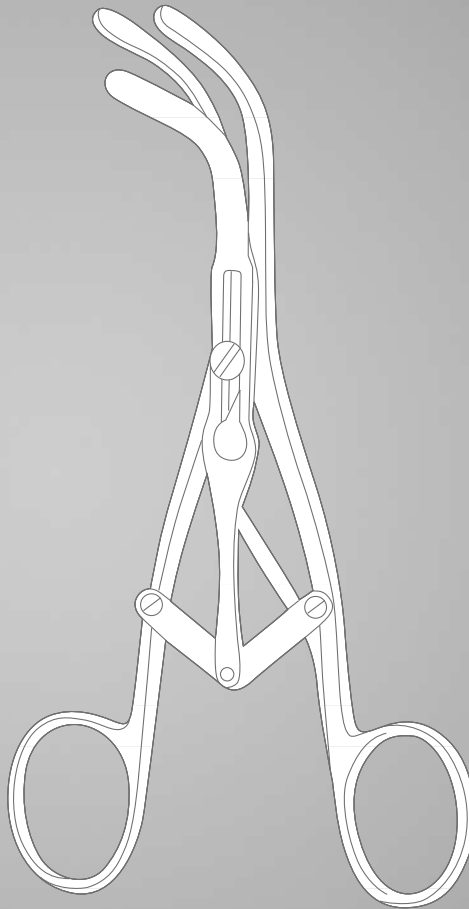






Tracheotomie  
Tracheotomy  
Traqueotomía  
Trachéotomie  
Tracheotomia

# 27



## Trachealdilatatoren

Tracheal Dilators

Dilatadores traqueales

Dilatateurs pour la trachéotomie

Dilatatori per tracheotomia



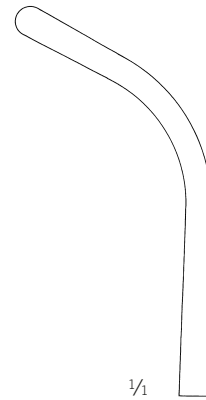
1/2

Laborde  
27-113-14-07  
14 cm / 5 5/8"



1/2

Trousseau  
27-115-14-07  
14,5 cm / 5 7/8"



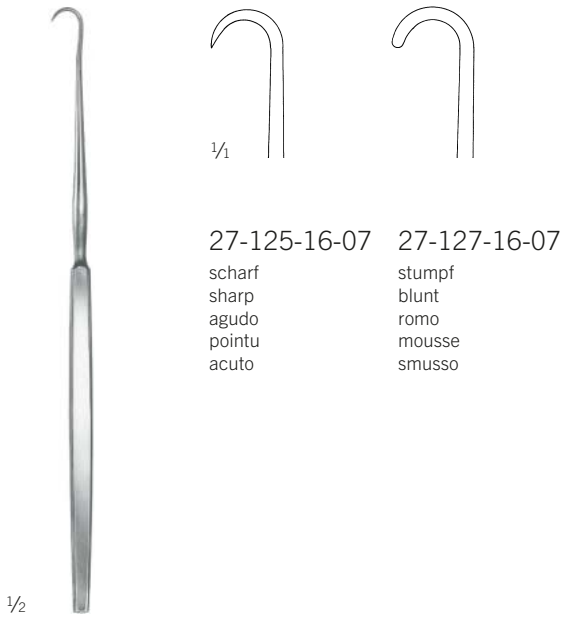
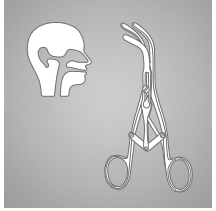
1/4

## Trachealhaken

Tracheal Hooks  
Ganchos traqueales  
Ecarteurs pour trachéotomie  
Uncini tracheali

## Tracheotomie

Tracheotomy  
Traqueotomía  
Trachéotomie  
Tracheotomia

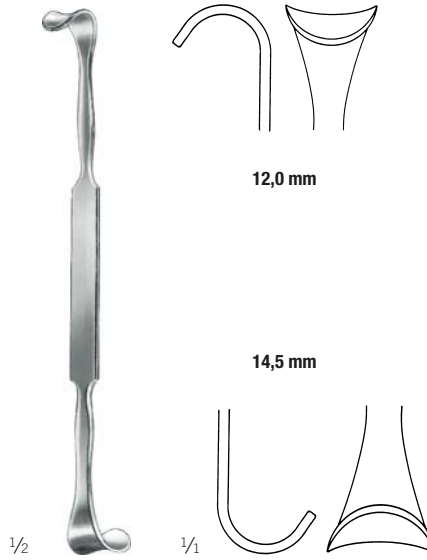


27-125-16-07

scharf  
sharp  
agudo  
pointu  
acuto

27-127-16-07

stumpf  
blunt  
romo  
mousse  
smusso



12,0 mm

14,5 mm

Iterson

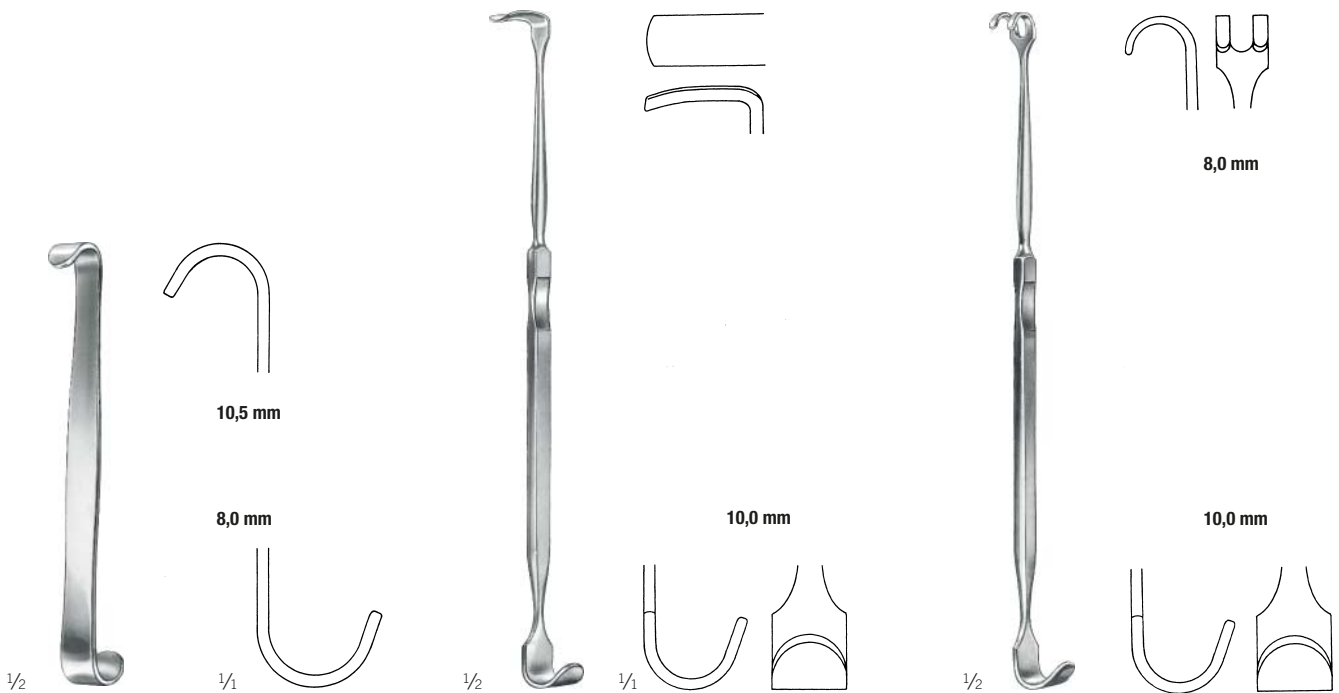
27-125-16-07 -  
27-127-16-07

17 cm / 6 5/8"

Rose

27-143-13-07

15,5 cm / 6 1/8"



10,5 mm

8,0 mm

10,0 mm

8,0 mm

10,0 mm

Luer

27-145-11-07

11 cm / 4 3/8"

Lukens

27-151-17-07

17,5 cm / 6 7/8"

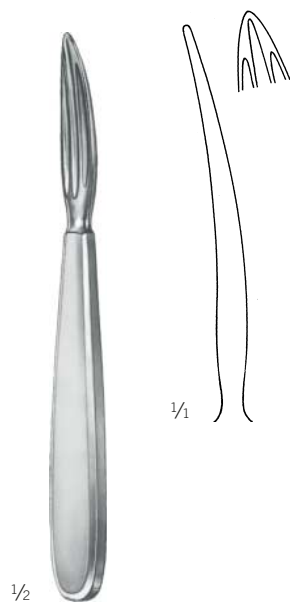
Jackson

27-155-17-07

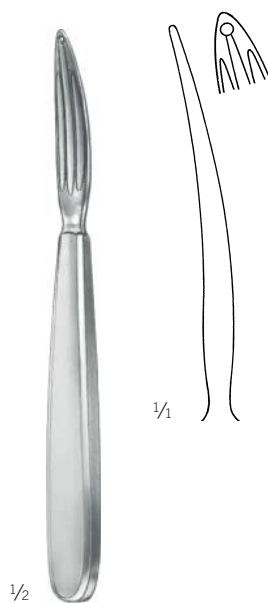
18 cm / 7 1/8"

## Kropfsonden, Kropffasszangen

Goitre Enucleator, Goitre Grasping Forceps  
 Sondas para bocio, Pinzas para coger el bocio  
 Spatules à goitre, Pincas à goitre  
 Sonde per gozzo, Pinze per gozzo



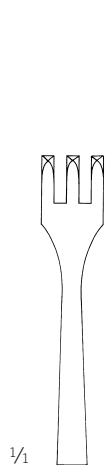
Kocher  
 27-411-15-07  
 15,5 cm / 6 1/8"



Kocher  
 27-413-15-07  
 15,5 cm / 6 1/8"  
 mit Loch  
 with eye  
 con agujero  
 avec trou  
 con foro



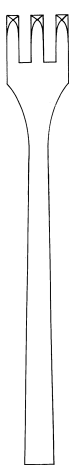
Lahey  
 27-449-15-07 -  
 27-449-20-07



27-449-15-07  
 15,5 cm / 6 1/8"



3:3



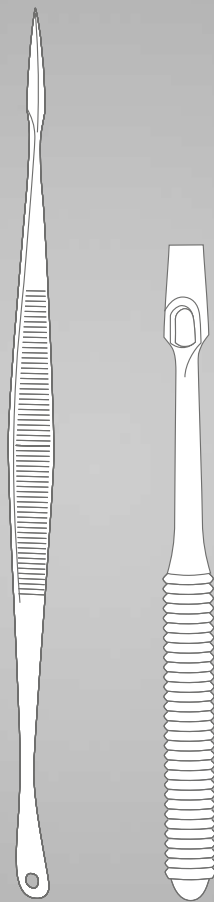
27-449-20-07  
 20 cm / 7 7/8"



3:3

Plastische Chirurgie  
Plastic Surgery  
Cirugía plástica  
Chirurgie plastique  
Chirurgia plastica

# 28



## Spezial-Produkte

Special Products

Productos especiales

Produits spéciaux

Prodotti speciali

Unser Katalog „Plastische Chirurgie“ enthält die gesamte Palette der KLS-Martin-Produkte für die plastische Chirurgie.

Our catalog “Plastic Surgery” contains the full range of KLS Martin products for plastic surgery.

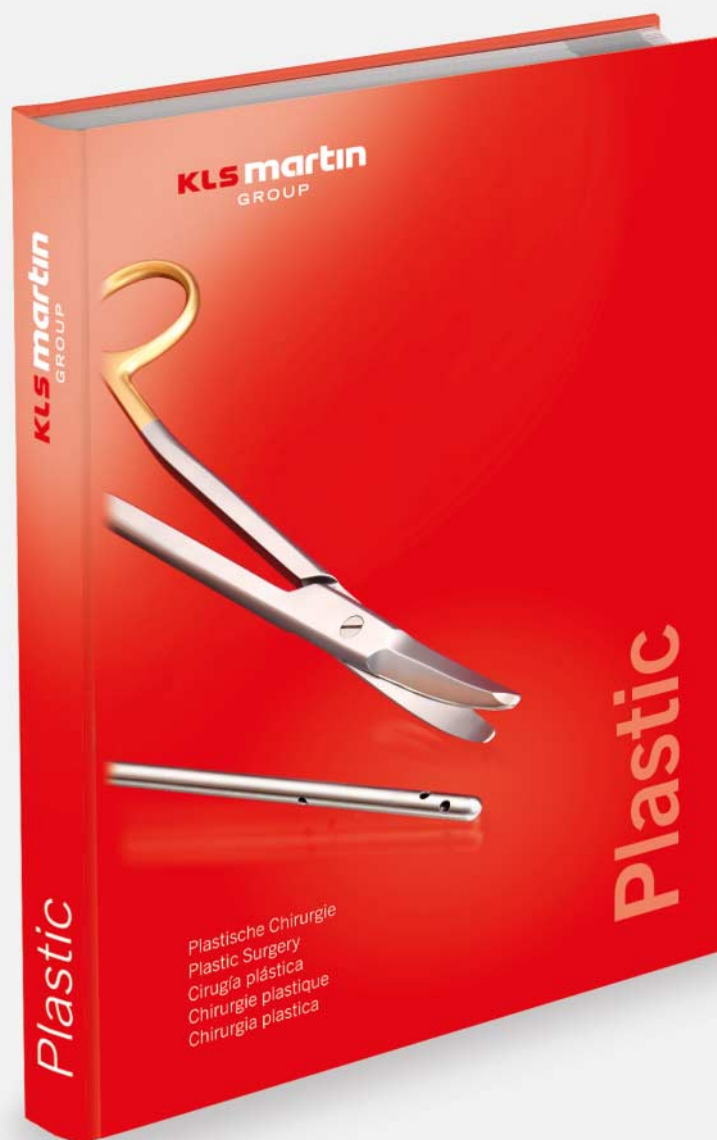
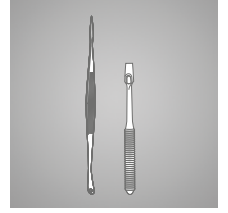
Nuestro catálogo “Cirugía plástica” incluye la gama completa de productos de KLS Martin para la cirugía plástica.

Notre catalogue «Chirurgie plastique» contient l’ensemble de la palette des produits de chirurgie plastique KLS Martin.

Il nostro catalogo “Chirurgia plastica” contiene la gamma completa degli prodotti per la chirurgia plastica di KLS Martin.

**Plastische Chirurgie**

Plastic Surgery  
Cirugía plástica  
Chirurgie plastique  
Chirurgia plastica

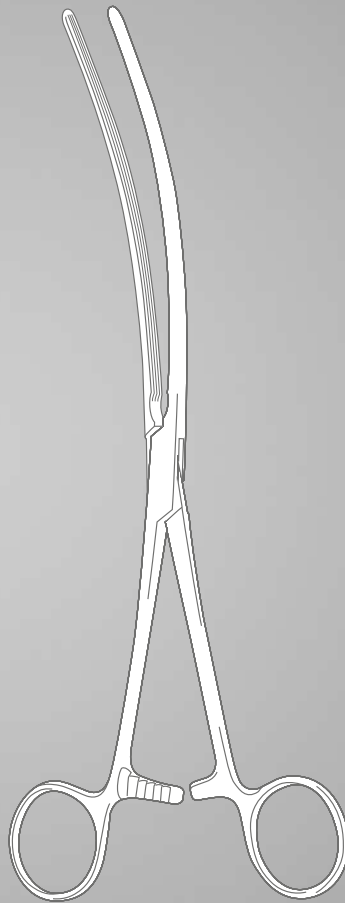






Magen, Darm, Rektum  
Stomach, Intestines, Rectum  
Estómago, Intestinos, Recto  
Estomac, Intestins, Rectum  
Stomaco, Intestini, Retto

# 30



## Darm- und Gewebefassungen

Intestinal and Tissue Grasping Forceps

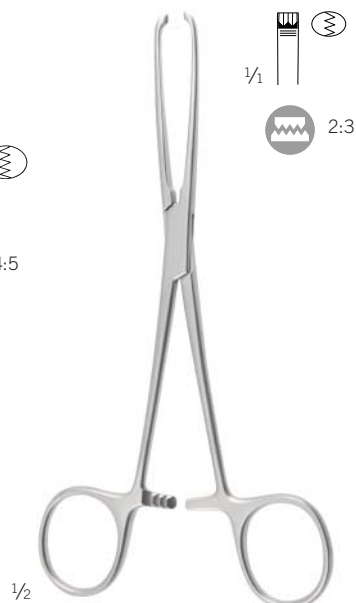
Pinzas para intestinos y tejidos

Pinces pour saisir intestins et tissus

Pinze per afferrare intestino e tessuti



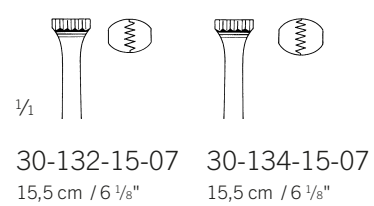
Allis-Baby  
30-130-12-07  
13 cm / 5 1/8"



Allis  
30-131-15-07  
15,5 cm / 6 1/8"

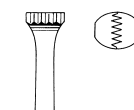


Allis  
30-132-15-07 -  
30-134-25-07

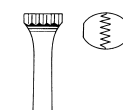


30-132-15-07  
15,5 cm / 6 1/8"

30-134-15-07  
15,5 cm / 6 1/8"



30-134-19-07  
19 cm / 7 4/8"



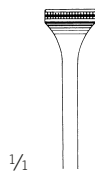
30-134-25-07  
25,5 cm / 10"



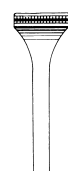
## Atrauma



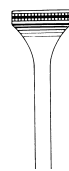
Allis  
30-136-16-07 -  
30-136-30-07



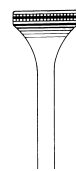
30-136-16-07  
15,5 cm / 6 1/8"



30-136-20-07  
20 cm / 7 7/8"



30-136-25-07  
24,5 cm / 9 5/8"



30-136-30-07  
30 cm / 11 6/8"

## Darm- und Gewebefassungen

Intestinal and Tissue Grasping Forceps

Pinzas para intestinos y tejidos

Pinces pour saisir intestins et tissus

Pinze per afferrare intestino e tessuti

## Magen, Darm, Rektum

Stomach, Intestines, Rectum

Estómago, Intestinos, Recto

Estomac, Intestins, Rectum

Stomaco, Intestini, Retto



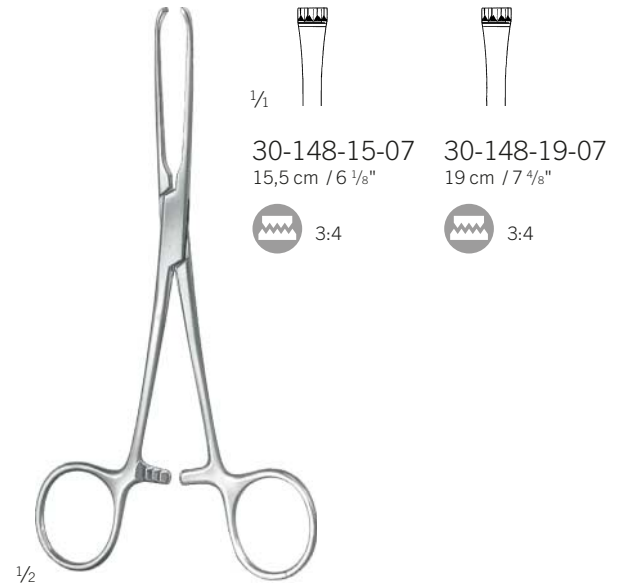
30



Allis-Adair  
30-138-15-07  
16 cm / 6 2/8"



Boys-Allis  
30-142-15-07  
15,5 cm / 6"



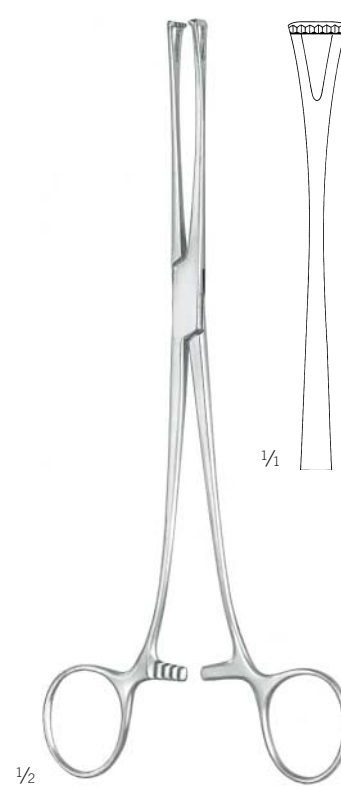
Judd-Allis  
30-148-15-07 -  
30-148-19-07



Thoms-Allis  
30-150-20-07  
20,5 cm / 8 1/8"



Allis  
30-154-20-07  
20 cm / 7 7/8"



Lockwood  
30-170-20-07  
20 cm / 7 7/8"

## Darm- und Gewebefassungen

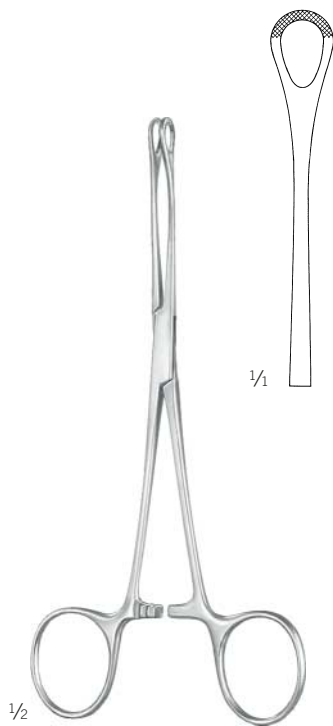
Intestinal and Tissue Grasping Forceps

Pinzas para intestinos y tejidos

Pinces pour saisir intestins et tissus

Pinze per afferrare intestino e tessuti

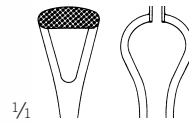
### TC GOLD



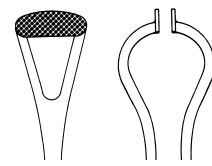
Williams  
30-186-16-07  
16,5 cm / 6 4/8"



Babcock  
30-190-16-07 -  
30-190-20-07



30-190-16-07  
16,5 cm / 6 4/8"



30-190-20-07  
21 cm / 8 2/8"

**Darm- und Gewebefasszangen**

Intestinal and Tissue Grasping Forceps

Pinzas para intestinos y tejidos

Pinces pour saisir intestins et tissus

Pinze per afferrare intestino e tessuti

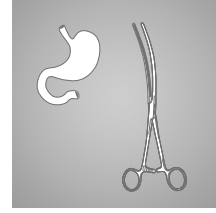
**Magen, Darm, Rektum**

Stomach, Intestines, Rectum

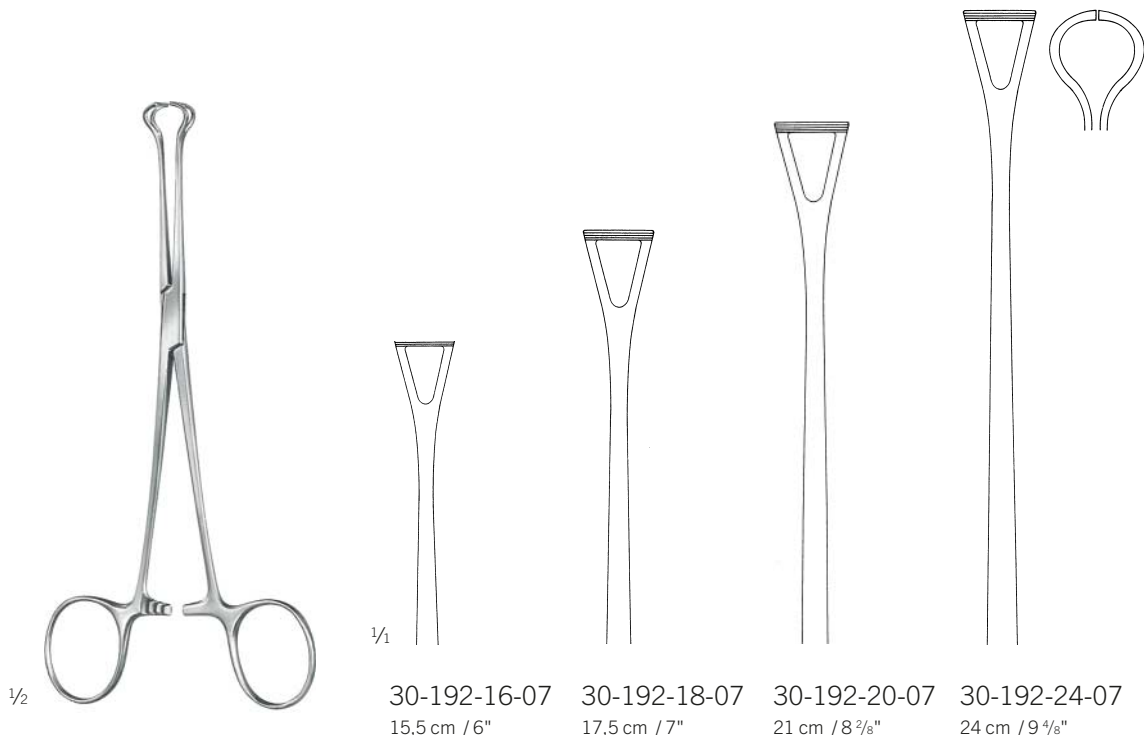
Estómago, Intestinos, Recto

Estomac, Intestins, Rectum

Stomaco, Intestini, Retto



30



1/2

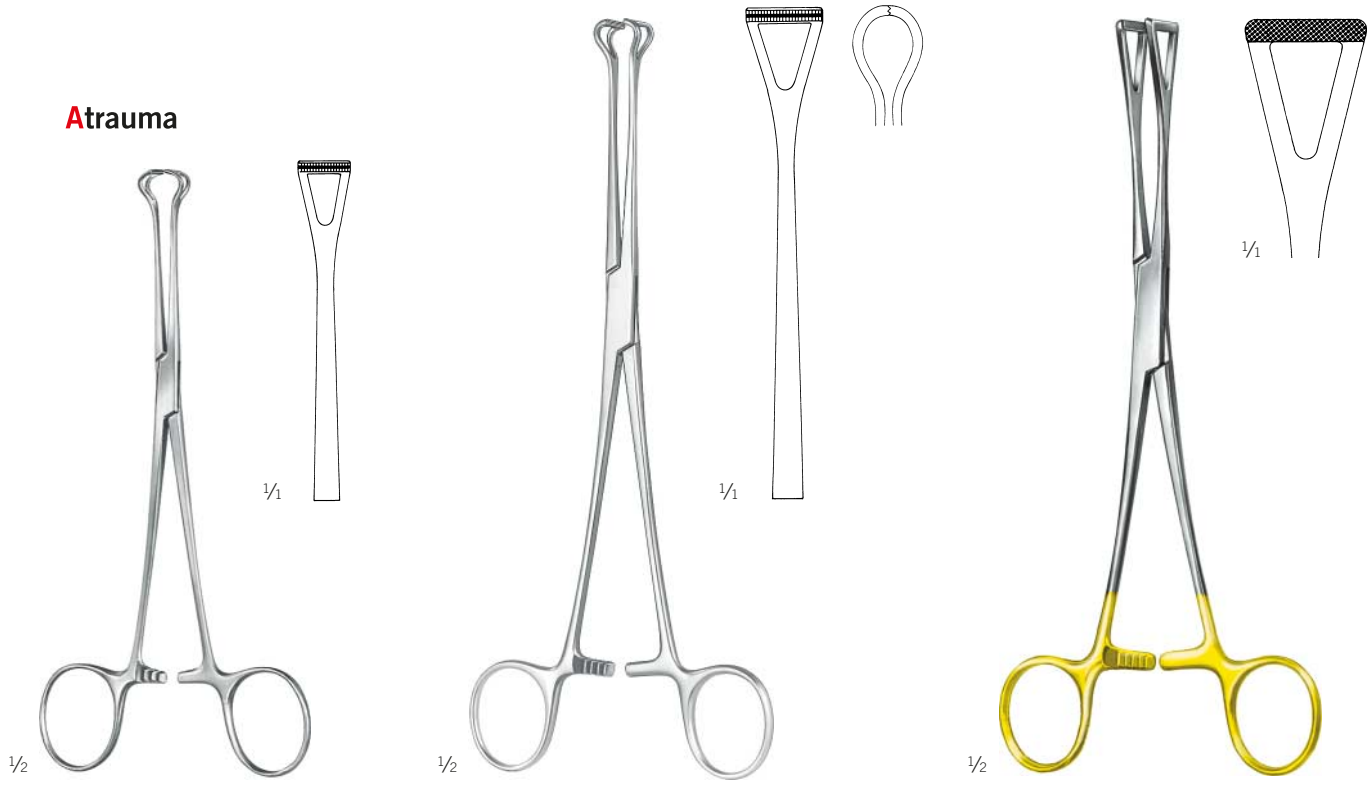
1/1

- 30-192-16-07  
15,5 cm / 6"
- 30-192-18-07  
17,5 cm / 7"
- 30-192-20-07  
21 cm / 8 2/8"
- 30-192-24-07  
24 cm / 9 4/8"

Babcock  
30-192-16-07 -  
30-192-24-07

**Atrauma**

**TC GOLD**



1/2

1/1

1/1

1/1

Babcock  
30-196-16-07  
16 cm / 6 2/8"

Babcock  
30-196-20-07  
21 cm / 8 2/8"

Duval  
30-206-20-07  
20,5 cm / 8"

## Darm- und Gewebefasszangen, Darmklemmen

Intestinal and Tissue Grasping Forceps, Intestinal Clamps

Pinzas para intestinos y tejidos, Pinzas intestinales

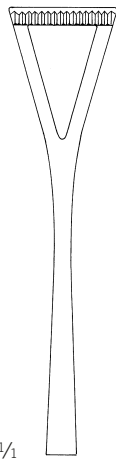
Pinces pour saisir intestins et tissus, Pincés intestinales

Pinze per afferrare intestino e tessuti, Pinze intestinali



1/2

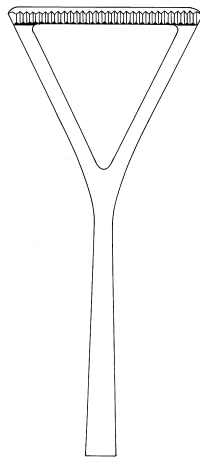
Duval  
30-210-18-07 -  
30-212-23-07



1/4

30-210-18-07  
18 cm / 7 1/8"

30-210-20-07  
20,5 cm / 8"



30-212-20-07  
20,5 cm / 8 1/8"

30-212-23-07  
23 cm / 9"



1/2

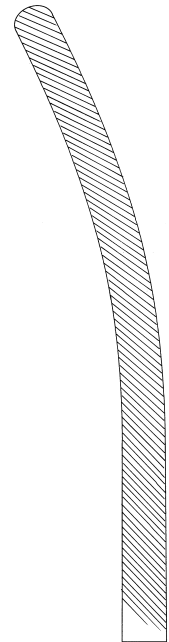
Doyen  
30-274-21-07 -  
30-275-23-07



1/4

30-274-21-07  
21,5 cm / 8 4/8"

30-274-23-07  
23,5 cm / 9 2/8"



30-275-21-07  
21 cm / 8 2/8"

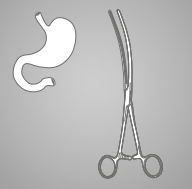
30-275-23-07  
23 cm / 9"

## Darmklemmen

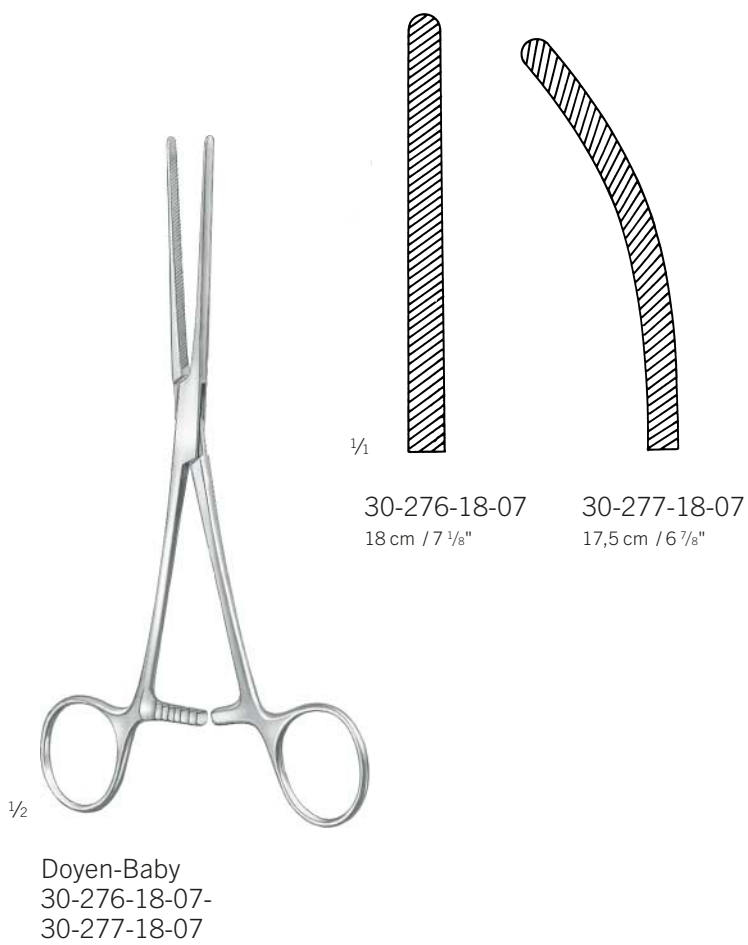
Intestinal Clamps  
Pinzas intestinales  
Pincas intestinales  
Pinze intestinali

## Magen, Darm, Rektum

Stomach, Intestines, Rectum  
Estómago, Intestinos, Recto  
Estomac, Intestins, Rectum  
Stomaco, Intestini, Retto



30



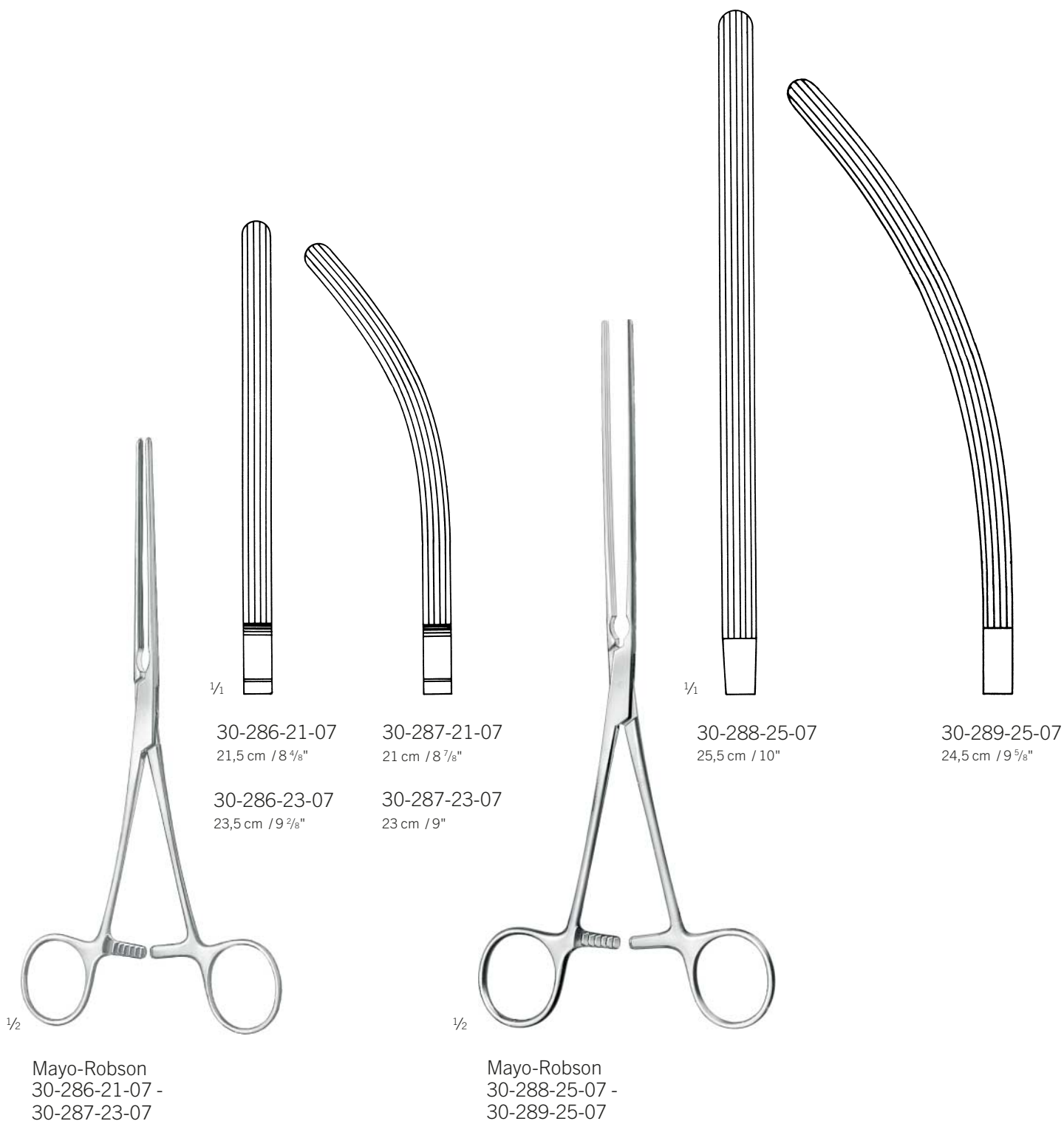
## Darmklemmen

Intestinal Clamps

Pinzas intestinales

Pinces intestinales

Pinze intestinali



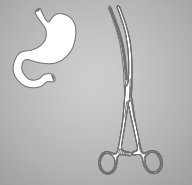


## Darmklemmen

Intestinal Clamps  
Pinzas intestinales  
Pincas intestinales  
Pinze intestinali

## Magen, Darm, Rektum

Stomach, Intestines, Rectum  
Estómago, Intestinos, Recto  
Estomac, Intestins, Rectum  
Stomaco, Intestini, Retto



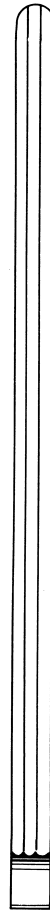
1/2

Kocher  
30-304-22-07 -  
30-304-28-07

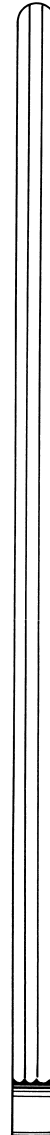
1/1



30-304-22-07  
22,5 cm / 8 7/8"



30-304-25-07  
25 cm / 9 7/8"



30-304-28-07  
28 cm / 11"

## Darmklemmen

Intestinal Clamps

Pinzas intestinales

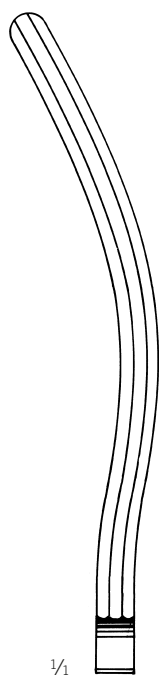
Pinces intestinales

Pinze intestinali



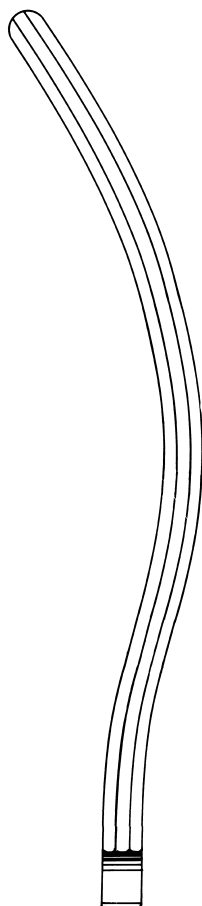
1/2

Kocher  
30-305-22-07 -  
30-305-28-07

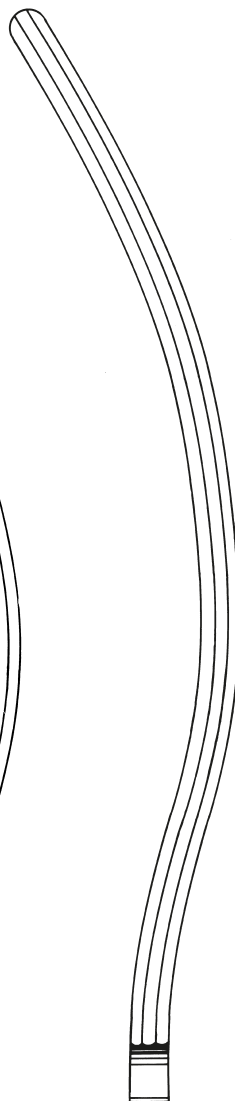


1/1

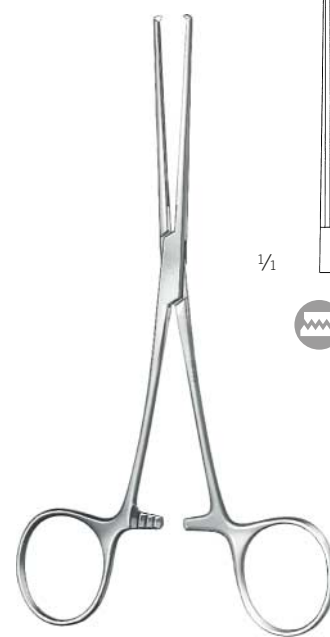
30-305-22-07  
22 cm / 8 5/8"



30-305-25-07  
24,5 cm / 9 5/8"



30-305-28-07  
27,5 cm / 10 5/8"



1/2

Allen  
30-398-16-07  
16 cm / 6 2/8"



1/1



1:2

## Darmquetschklemmen

Intestinal and Pylorus Clamps

Pinzas intestinales para píloro

Ecraseurs pour intestin

Schiacciatori intestinali

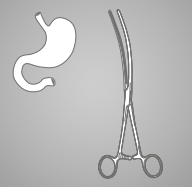
## Magen, Darm, Rektum

Stomach, Intestines, Rectum

Estómago, Intestinos, Recto

Estomac, Intestins, Rectum

Stomaco, Intestini, Retto



30



Payr-Baby  
30-415-15-07

15 cm / 5 7/8"

mit Stift  
with pin  
con espiga  
avec cheville  
con perno



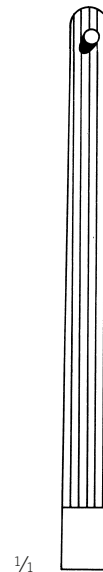
1/4



1/2

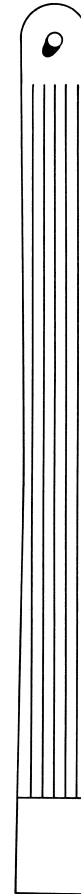
Payr  
30-419-21-07 -  
30-433-35-07

mit Stift  
with pin  
con espiga  
avec cheville  
con perno

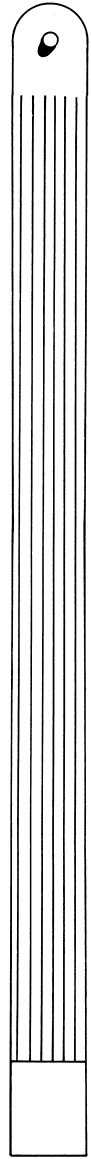


1/4

30-419-21-07  
21 cm / 8 2/8"



30-425-29-07  
29 cm / 11 3/8"



30-433-35-07  
34 cm / 13 3/8"

## Darm-Anastomosenklemmen

Intestinal Anastomosis Clamps

Clamps para anastomosis intestinales

Pinces pour anastomoses intestinales

Pinze per anastomosi intestinali



1/2

30-496-05-07

Arbeitslänge  
working length  
largo útil  
longueur utile  
lunghezza utile

**65 mm**

30-496-07-07

Arbeitslänge  
working length  
largo útil  
longueur utile  
lunghezza utile

**80 mm**

30-496-10-07

Arbeitslänge  
working length  
largo útil  
longueur utile  
lunghezza utile

**110 mm**



1/2

De Martel-Wolfson

30-496-05-07 -  
30-496-10-07

Set bestehend aus 3 Stück einer Länge:

- 2 x Riegel kurz
- 1 x Riegel lang

Set consisting of 3 pieces of one length:

- 2 x lock, short
- 1 x lock, long

Juego formado por 3 piezas de una longitud:

- 2 x pestillo corto
- 1 x pestillo largo

Set composé de 3 pièces d'une longueur:

- 2 x verrou, court
- 1 x verrou, long

Set composto da 3 pezzi di una lunghezza:

- 2 x serrature corte
- 1 x serratura lunga

De Martel-Wolfson

30-497-26-07

27 cm / 10 5/8"

Klemmschließzange

Closing Forceps

Pinza para cerrar grapas

Pinces pour fermer les clips

Serrapinze



**30-496-05-07 -**

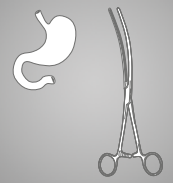
**30-496-10-07**

## Darm-Anastomosenklemmen

Intestinal Anastomosis Clamps  
Clamps para anastomosis intestinales  
Pincas pour anastomoses intestinale  
Pinze per anastomosi intestinali

## Magen, Darm, Rektum

Stomach, Intestines, Rectum  
Estómago, Intestinos, Recto  
Estomac, Intestins, Rectum  
Stomaco, Intestini, Retto



30



1/2

De Martel-Wolfson  
30-498-08-07

9,5 cm / 3 9/16"

Klemmenhalterung  
Clamp Holder  
Porta-clamp  
Porte-clamps  
Portapinze



30-496-05-07 -  
30-496-10-07



1/2

De Martel-Wolfson  
30-498-23-07

23 cm / 9"

Klemmenhalterung  
Clamp Holder  
Porta-clamp  
Porte-clamps  
Portapinze



30-496-05-07 -  
30-496-10-07



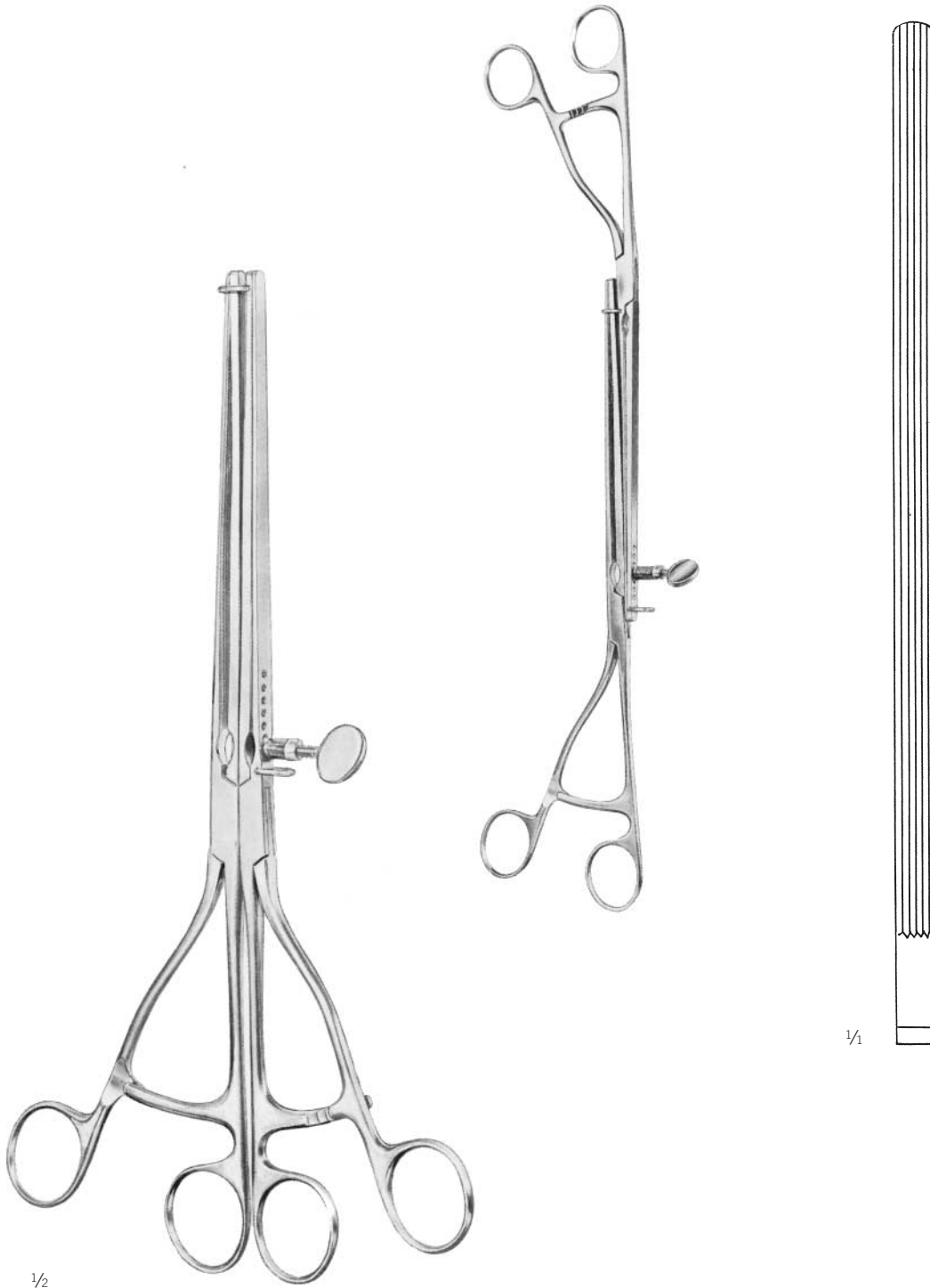
1/2

Benson  
30-519-16-07

15,5 cm / 6 1/8"

Pylorusspreizer  
Pylorus Spreader  
Separador para piloro  
Ecarteur pour pylore  
Divaricitaore pilorio

**Magen- und Darm-Zwillingsklemmen**  
Stomach and Intestinal Anastomosis Twin Clamps  
Pinzas gastro-intestinales gemales  
Pincas stomaches et intestinales jumelées  
Pinze gastrointestinali gemelle



Lane  
30-534-30-07  
30 cm / 11 <sup>6</sup>/<sub>8</sub>"

## Magen- und Darm-Zwillingsklemmen

Stomach and Intestinal Anastomosis Twin Clamps

Pinzas gastro-intestinales gemelas

Pinces stomacales et intestinales jumelées

Pinze gastrointestinali gemelle

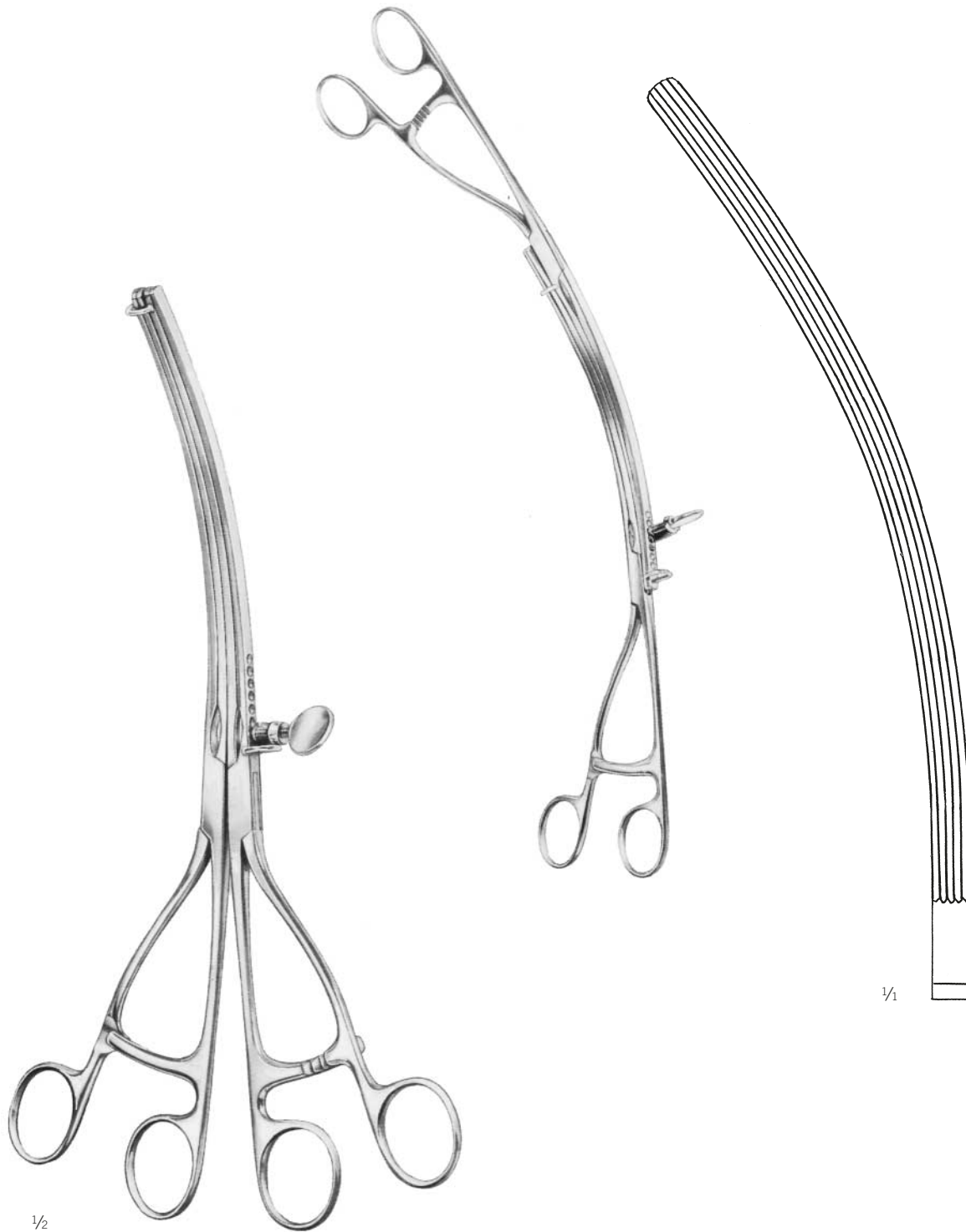
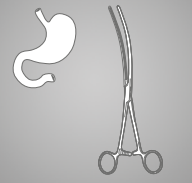
## Magen, Darm, Rektum

Stomach, Intestines, Rectum

Estómago, Intestinos, Recto

Estomac, Intestins, Rectum

Stomaco, Intestini, Retto



1/2

1/1

Lane  
30-535-30-07  
30 cm / 11 5/8"

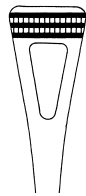
## Organfasszangen

Organ Grasping Forceps  
Pinzas para coger órganos  
Pinces pour saisir des organes  
Pinze per afferrare organi

### Atrauma



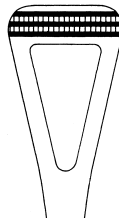
1/1



30-540-18-07

18 cm / 7 1/8"

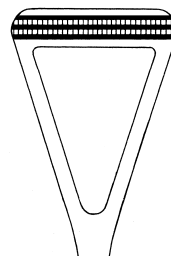
schmal  
narrow  
estrecho  
étroit  
strett



30-540-20-07

20,5 cm / 8 1/8"

mittel  
medium  
mediano  
moyen  
medio



30-540-23-07

23 cm / 9"

breit  
wide  
ancho  
large  
largo

1/2

Scheibe  
30-540-18-07 -  
30-540-23-07

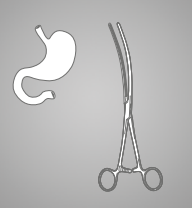


**Darmklemmen**

Intestinal Clamps  
Pinzas intestinales  
Pincas intestinales  
Pinze intestinali

**Magen, Darm, Rektum**

Stomach, Intestines, Rectum  
Estómago, Intestinos, Recto  
Estomac, Intestins, Rectum  
Stomaco, Intestini, Retto



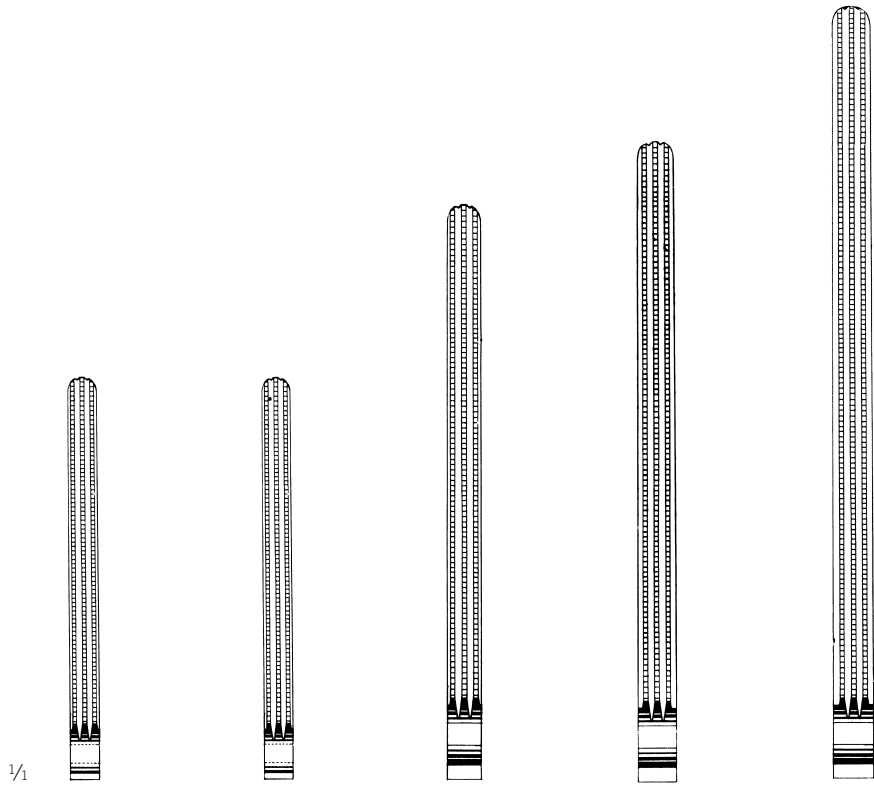
30

**Atrauma**



1/2

Doyen-Baby  
30-550-13-07 -  
30-550-23-07



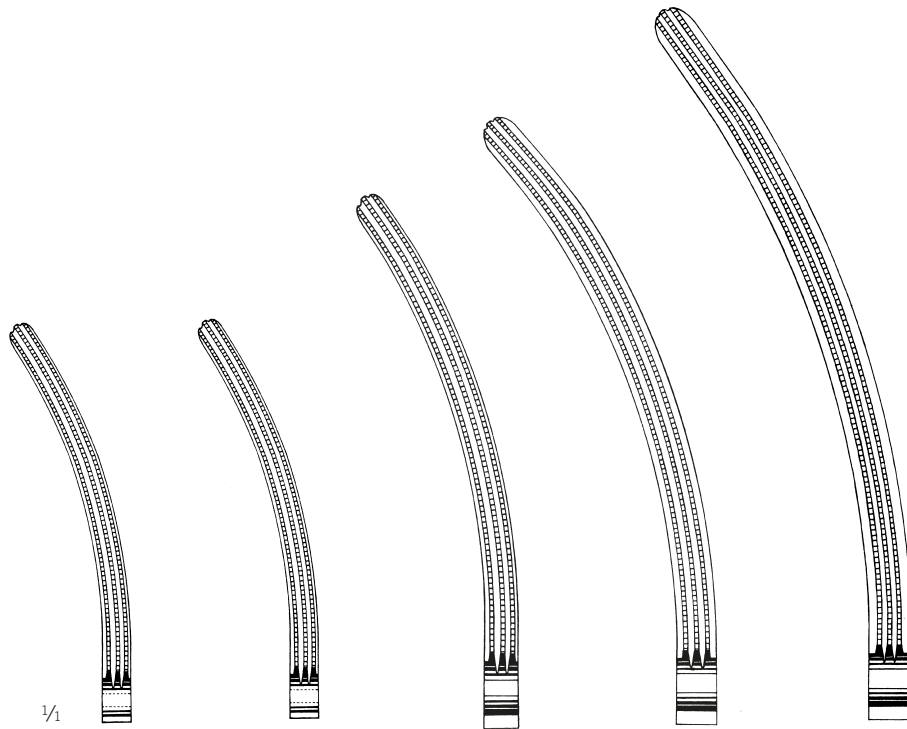
1/4

|                |                |                  |                  |                  |
|----------------|----------------|------------------|------------------|------------------|
| 30-550-13-07   | 30-550-16-07   | 30-550-18-07     | 30-550-21-07     | 30-550-23-07     |
| 14 cm / 5 4/8" | 17 cm / 6 5/8" | 18,5 cm / 7 3/8" | 21,5 cm / 8 4/8" | 23,5 cm / 9 2/8" |



1/2

Doyen-Baby  
30-551-13-07 -  
30-551-23-07



1/4

|                  |                |              |                |              |
|------------------|----------------|--------------|----------------|--------------|
| 30-551-13-07     | 30-551-16-07   | 30-551-18-07 | 30-551-21-07   | 30-551-23-07 |
| 13,5 cm / 5 2/8" | 17 cm / 6 5/8" | 18 cm / 7"   | 21 cm / 8 2/8" | 23 cm / 9"   |

## Darmklemmen

Intestinal Clamps  
Pinzas intestinales  
Pinces intestinales  
Pinze intestinali

### Atrauma



Mayo-Robson  
30-554-25-07  
26 cm / 10 <sup>3</sup>/<sub>8</sub>"



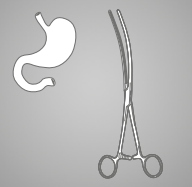
Mayo-Robson  
30-555-25-07  
25 cm / 9 <sup>3</sup>/<sub>8</sub>"

## Darmklemmen

Intestinal Clamps  
Pinzas intestinales  
Pincas intestinales  
Pinze intestinali

## Magen, Darm, Rektum

Stomach, Intestines, Rectum  
Estómago, Intestinos, Recto  
Estomac, Intestins, Rectum  
Stomaco, Intestini, Retto



## Atrauma

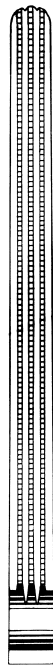
30



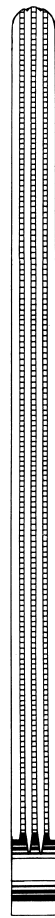
1/2

Kocher  
30-560-22-07 -  
30-560-28-07

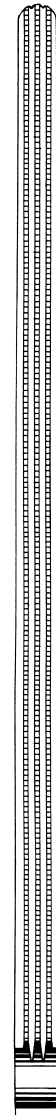
1/1



30-560-22-07  
22,5 cm / 8 7/8"



30-560-25-07  
25 cm / 9 7/8"



30-560-28-07  
28 cm / 11"

## Darmklemmen

Intestinal Clamps

Pinzas intestinales

Pinces intestinales

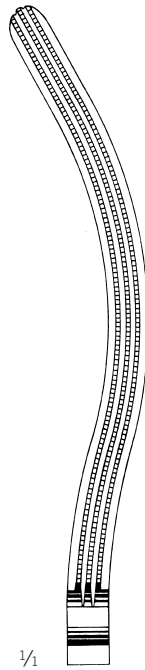
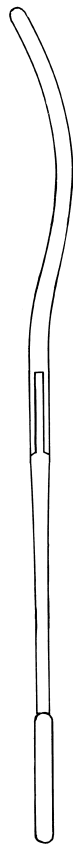
Pinze intestinali

### Atrauma



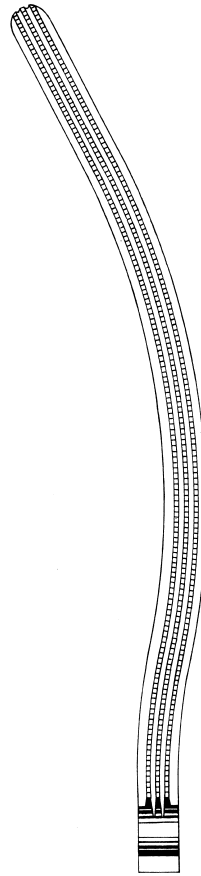
1/2

Kocher  
30-561-22-07 -  
30-561-28-07

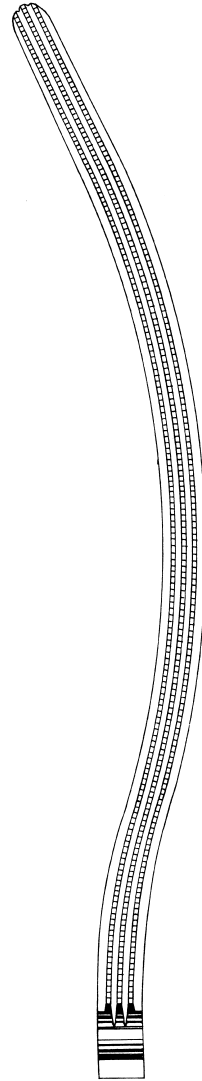


1/1

30-561-22-07  
22 cm / 8 5/8"



30-561-25-07  
24,5 cm / 9 5/8"



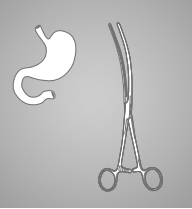
30-561-28-07  
27 cm / 10 5/8"

## Darmklemmen

Intestinal Clamps  
Pinzas intestinales  
Pincas intestinales  
Pinze intestinali

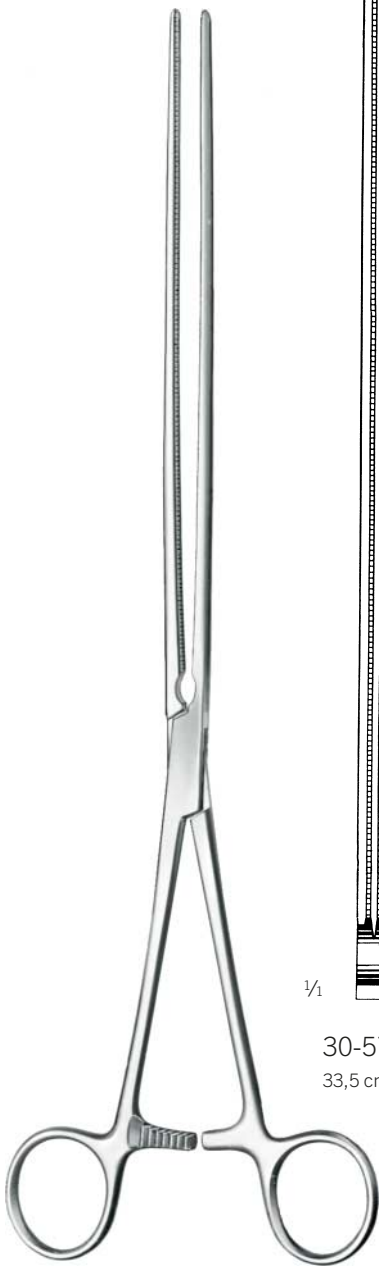
## Magen, Darm, Rektum

Stomach, Intestines, Rectum  
Estómago, Intestinos, Recto  
Estomac, Intestins, Rectum  
Stomaco, Intestini, Retto



## Atrauma

30

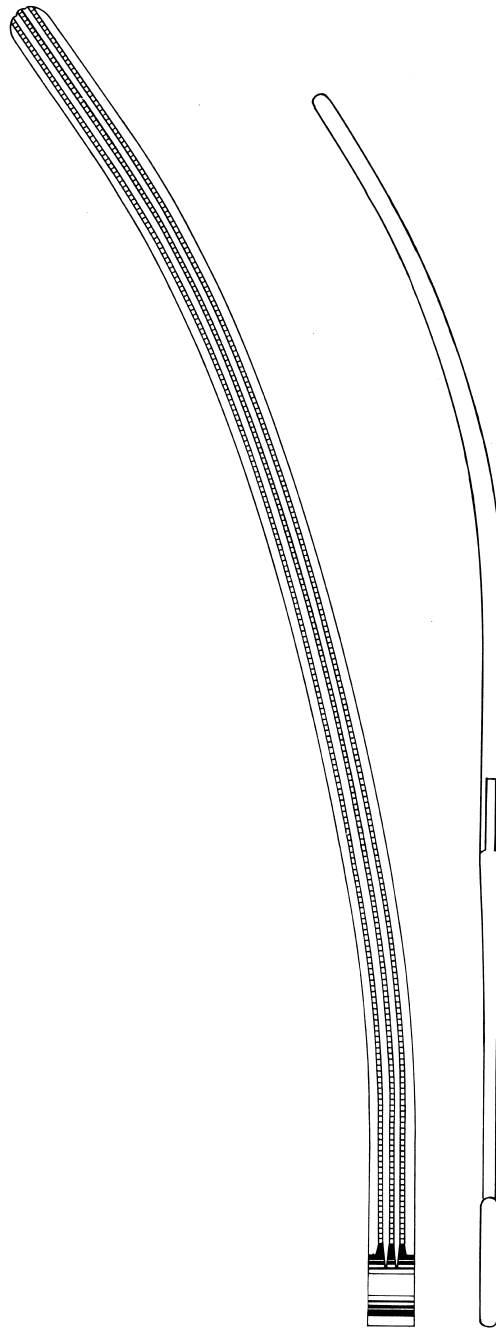


1/2

30-570-33-07  
33,5 cm / 13 2/8"

1/2

Scudder  
30-570-33-07 -  
30-571-33-07



1/2

30-571-33-07  
32,5 cm / 12 6/8"

1/2

Brunner  
30-580-24-07  
27 cm / 10 6/8"

## Rektum-Anastomosenklemmen

Sigmoid Anastomosis Forceps  
Pinzas para anastomosis rectales  
Pinces pour anastomoses rectales  
Pinze per anastomosi rettali

### Atrauma



Hayes  
30-581-26-07 -  
30-581-28-07



30-581-26-07  
27 cm / 10 5/8"

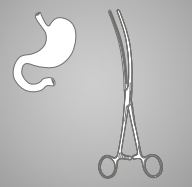
30-581-28-07  
28 cm / 11"

## Rektum-Anastomosenklemmen

Sigmoid Anastomosis Forceps  
Pinzas para anastomosis rectales  
Pincés pour anastomoses rectales  
Pinze per anastomosi rettali

## Magen, Darm, Rektum

Stomach, Intestines, Rectum  
Estómago, Intestinos, Recto  
Estomac, Intestins, Rectum  
Stomaco, Intestini, Retto



## Atrauma

30



Veidenheimer  
30-583-23-07  
25 cm / 9 <sup>5</sup>/<sub>8</sub>"

Fehland  
30-585-24-07  
24 cm / 9 <sup>4</sup>/<sub>8</sub>"

## Rektum-Anastomosenklemmen

Sigmoid Anastomosis Forceps  
Pinzas para anastomosis rectales  
Pinces pour anastomoses rectales  
Pinze per anastomosi rettali

### Atrauma



Resano  
30-587-30-07  
28 cm / 11"



## Mastdarmspekula, Analspreizer

Rectal Specula, Rectal Spreaders

Espéculos rectales, Separadores rectales

Spéculums rectaux, Ecarteurs rectaux

Specoli rettali, Divaricatori rettali

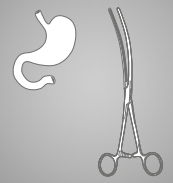
## Magen, Darm, Rektum

Stomach, Intestines, Rectum

Estómago, Intestinos, Recto

Estomac, Intestins, Rectum

Stomaco, Intestini, Retto



30



105 x 23 mm

1/2

Czerny  
30-610-21-07  
22,5 cm / 8 7/8"



70 x 15 mm

1/2

Sims  
30-613-15-01  
15,5 cm / 6 1/8"



70 x 15 mm

1/2

Sims  
30-615-15-01  
15,5 cm / 6 1/8"



80 x 25 mm

1/2

Pratt  
30-624-20-07  
20 cm / 7 7/8"



Ø 22 mm

1/2

Ives-Fansler  
30-641-15-07  
Analspreizer  
Rectal Spreaders  
Separadores rectales  
Ecarteurs rectaux  
Divaricatori rettali

Arbeitslänge  
working length  
largo útil  
longueur utile  
lunghezza utile  
80 mm

## Anal spreizer

Rectal Spreaders

Separadores rectales

Ecarteurs rectaux

Divaricatori rettali



1/2

Alan-Parks

30-647-00-07 -  
30-647-95-98

30-647-00-07

14 cm / 5 4/8"

ohne Kaltlichtaufsatz, komplett mit 2 paar Seiten-Valven sowie 1 Mittelvalve  
without F.O. light carrier, complete with 2 pairs of lateral blades and 1 central blade  
sin portador de luz fría, completo con 2 parejas de valvas laterales y 1 valva central  
sans support lumière froide, complet avec 2 paires de valves latérales et 1 valve centrale  
senza supporto per luce fredda, completo di 2 coppie di valve laterali e di 1 valva centrale



30-647-94-98

Paar Seitenvalven lang, Nutzlänge 95 mm  
Pair of lateral blades, long, useful length 95 mm  
Un par de valvas laterales, largas, longitud útil 95 mm  
Paire de valves latérales, longues, longueur utile 95 mm  
Coppia di valve laterali lunghe, lungh. utile 95 mm

30-647-95-98

Mittelvalve, Nutzlänge 95 mm  
Central Blade, useful length 95 mm  
Valva central, longitud útil 95 mm  
Valve centrale, longueur utile 95 mm  
Valva centrale, lungh. utile 95 mm

30-647-92-98

Flügelmutter  
Wing nut  
Tuerca de mariposal  
Ecrou à oreilles  
Madrevite ad alette

30-647-93-98

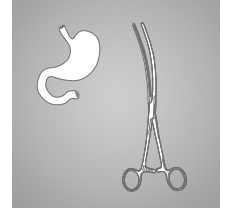
Paar Seitenvalven kurz, Nutzlänge 75 mm  
Pair of lateral blades, short, useful length 75 mm  
Un par de valvas laterales, cortas, longitud útil 75 mm  
Paire de valves latérales, courtes, longueur utile 75 mm  
Coppia di valve laterali corte, lungh. utile 75 mm

## Sphinkteroskope

Sphincteroscopes  
Esfincteroscopios  
Sphinctérosopes  
Sfincteroscopi

## Magen, Darm, Rektum

Stomach, Intestines, Rectum  
Estómago, Intestinos, Recto  
Estomac, Intestins, Rectum  
Stomaco, Intestini, Retto



30



1/2

30-649-01-07

**Ø 21 mm**

Arbeitslänge  
working length  
largo útil  
longueur utile  
lunghezza utile

**50 mm**

30-649-02-07

**Ø 27 mm**

Arbeitslänge  
working length  
largo útil  
longueur utile  
lunghezza utile

**50 mm**

Kelly  
30-649-01-07 -  
30-649-02-07

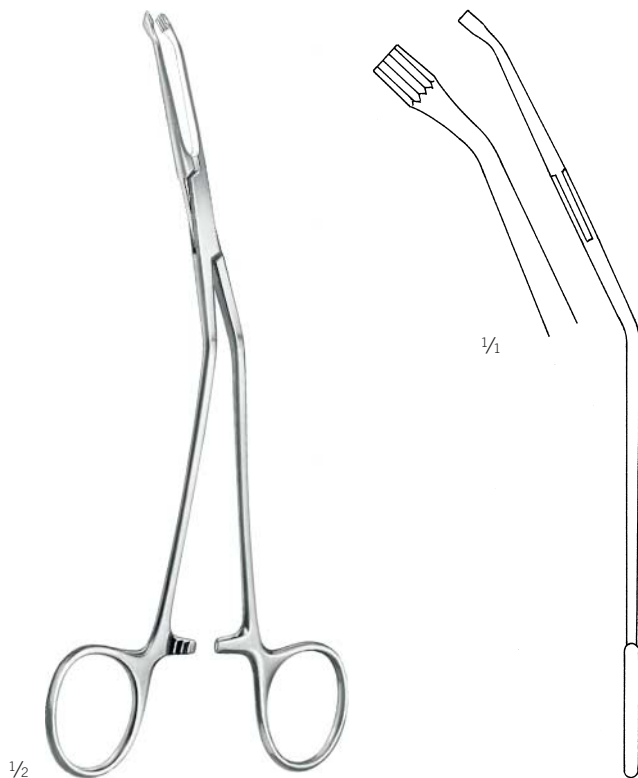
## Hämorrhoidal-Faßzange, Rektum-Biopsiefasszangen

Hemorrhoidal Ligator, Rectal Biopsy Forceps

Ligador para hemorroides, Pinzas para biopsia rectal

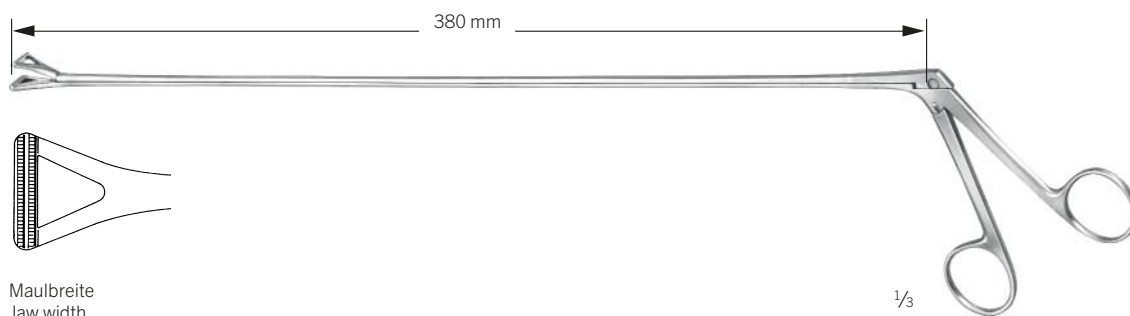
Ligateur pour hémorroides, Pinces pour biopsie rectale

Legatore emorroidale, Pinze per biopsia rettale



McGinvey  
30-724-19-07  
19,5 cm / 7 5/8"

## Atrauma



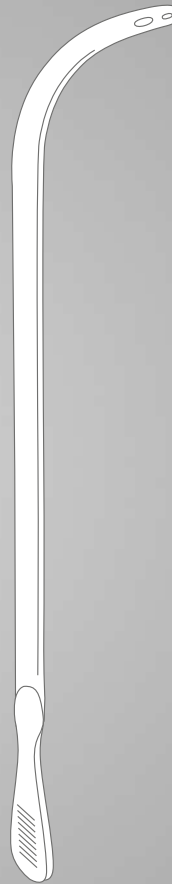
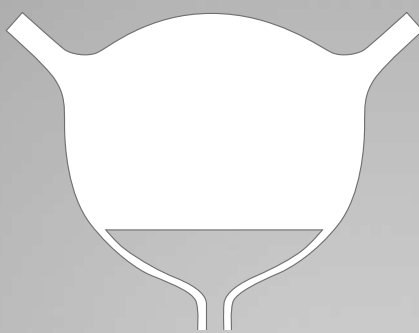
Maulbreite  
Jaw width  
Anchura de la boca  
Lageur de mors  
Larghezza della bocca

**15 mm**

30-741-38-07  
38 cm / 15"

Urologie  
Urology  
Urología  
Urologie  
Urologia

# 31



# Nierensteinzangen

Kidney Stone Forceps

Pinzas para cálculos renales

Pinces pour les calculs du bassinet

Pinze per calcoli renali



1/2

Randall  
31-101-23-07 -  
31-107-22-07

1/1

Fig. 1  
31-101-23-07  
23 cm / 9"

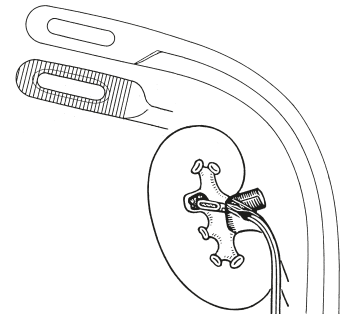


Fig. 2  
31-103-22-07  
21 cm / 8 2/8"

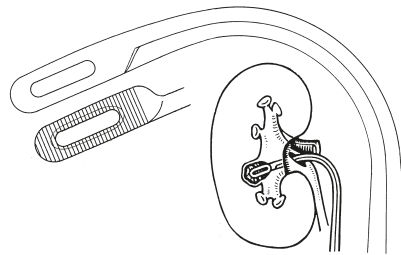


Fig. 3  
31-105-22-07  
19 cm / 7 4/8"

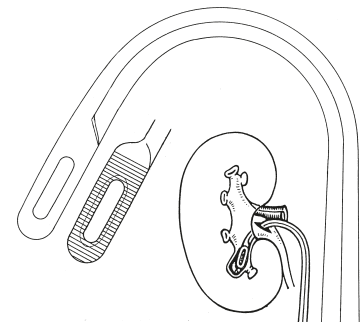


Fig. 4  
31-107-22-07  
18,5 cm / 7 2/8"



1/2

Heiming  
31-113-16-07 -  
31-113-17-07

für Kinder  
for children  
para niños  
pour enfants  
per bambini

1/1

Fig. 1  
31-113-16-07  
16 cm / 6 2/8"

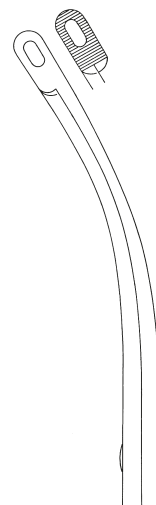


Fig. 2  
31-113-17-07  
17 cm / 6 6/8"

# Gallenkanaldilatatoren

Gall Duct Dilators

Dilatadores para conducto biliar

Dilatateurs pour les voies biliaires

Dilatatori per condotti biliari

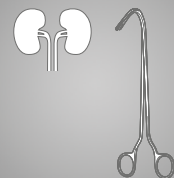
# Urologie

Urology

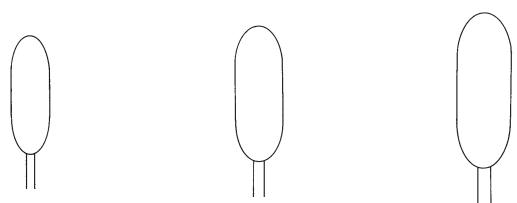
Urología

Urologie

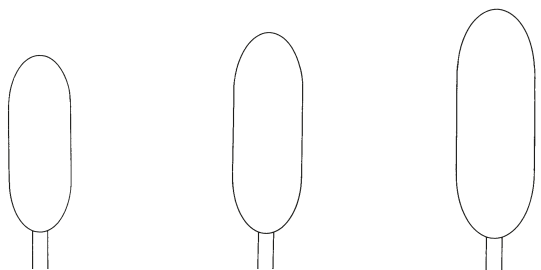
Urologia



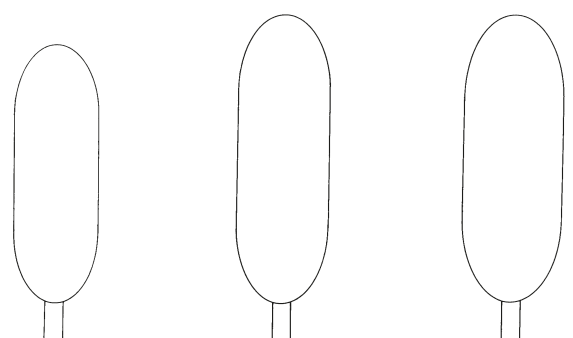
| Fig. 1       | Fig. 2       | Fig. 3       | Fig. 4       |
|--------------|--------------|--------------|--------------|
| Ø 1,0 mm     | Ø 2,0 mm     | Ø 3,0 mm     | Ø 4,0 mm     |
| 31-170-01-01 | 31-170-02-01 | 31-170-03-01 | 31-170-04-01 |



| Fig. 5       | Fig. 6       | Fig. 7       |
|--------------|--------------|--------------|
| Ø 5,0 mm     | Ø 6,0 mm     | Ø 7,0 mm     |
| 31-170-05-01 | 31-170-06-01 | 31-170-07-01 |



| Fig. 8       | Fig. 9       | Fig. 10      |
|--------------|--------------|--------------|
| Ø 8,0 mm     | Ø 9,0 mm     | Ø 10 mm      |
| 31-170-08-01 | 31-170-09-01 | 31-170-10-01 |



| Fig. 11      | Fig. 12      | Fig. 13      |
|--------------|--------------|--------------|
| Ø 11 mm      | Ø 12 mm      | Ø 13 mm      |
| 31-170-11-01 | 31-170-12-01 | 31-170-13-01 |



1/2

## Bakes

31-170-01-01 -

31-170-13-01

32 cm / 12 5/8"

biegsamer Schaft

malleable shaft

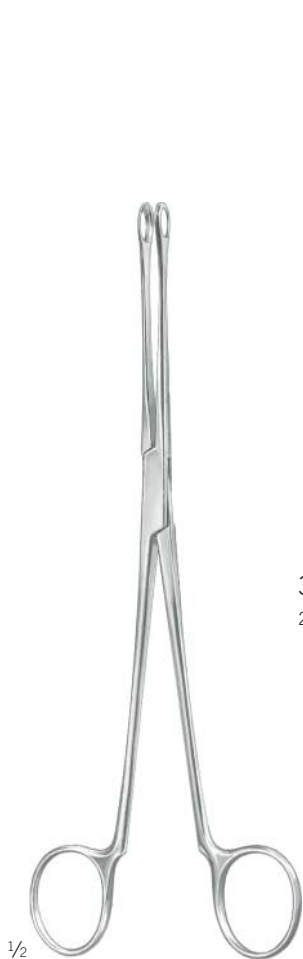
vástago maleable

tige malléable

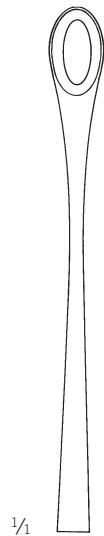
gambo malleabile

## Gallensteinzangen

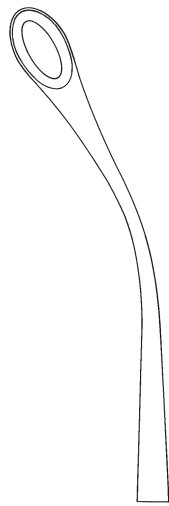
Gall Stone Forceps  
Pinzas para cálculos biliares  
Pinces pour calculs biliaires  
Pinze per calcoli biliari



Blake  
31-204-20-07 -  
31-205-20-07



31-204-20-07  
21 cm / 8 2/8"



31-205-20-07  
20,5 cm / 8 1/8"



Mayo-Blake  
31-215-20-07  
21 cm / 8 2/8"



## Gallensteinzangen

Gall Stone Forceps

Pinzas para cálculos biliares

Pinces pour calculs biliaires

Pinze per calcoli biliari

## Urologie

Urology

Urología

Urologie

Urologia



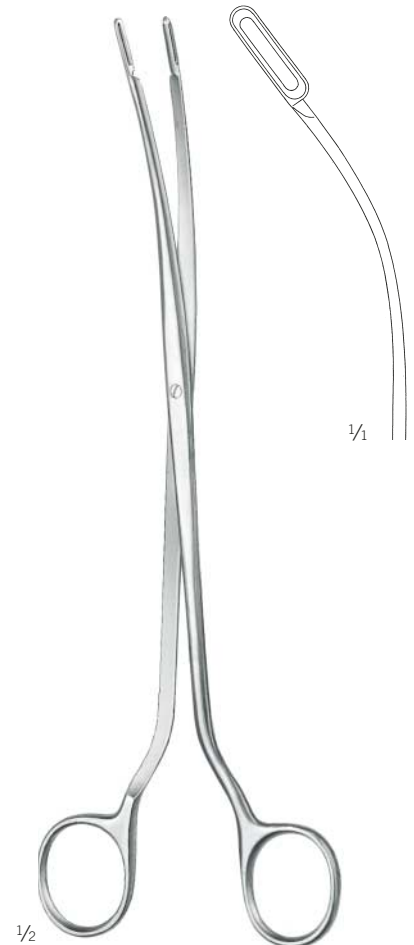
Mixer  
31-217-22-07  
22 cm / 8 5/8"



Desjardins  
31-223-23-07 -  
31-225-23-07  
23 cm / 9"

Fig. 1  
31-223-23-07

Fig. 2  
31-225-23-07



Desjardins  
31-226-25-07  
23 cm / 9"

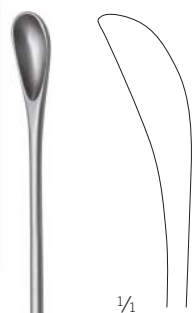
## Gallensteinlöffel

Gall Stone Scoops

Cucharas para cálculos biliares

Curettes pour calculs biliaires

Pinze per calcoli biliari



1/4



1/4



| Fig. 000     | Fig. 00      | Fig. 0       | Fig. 1       |
|--------------|--------------|--------------|--------------|
| 2,7 mm       | 3,4 mm       | 4,3 mm       | 5,5 mm       |
| 31-340-01-07 | 31-340-02-07 | 31-340-03-07 | 31-340-04-07 |



1/4



| Fig. 2       | Fig. 3       | Fig. 4       | Fig. 5       |
|--------------|--------------|--------------|--------------|
| 6,6 mm       | 8 mm         | 11 mm        | 15 mm        |
| 31-340-05-07 | 31-340-06-07 | 31-340-07-07 | 31-340-08-07 |

1/2

Luer-Körte  
31-340-01-07 -  
31-340-08-07

32 cm / 12 5/8"

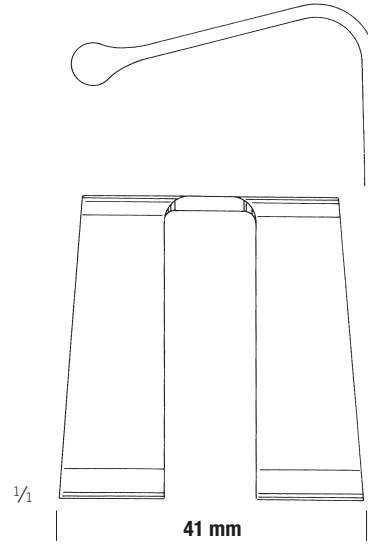
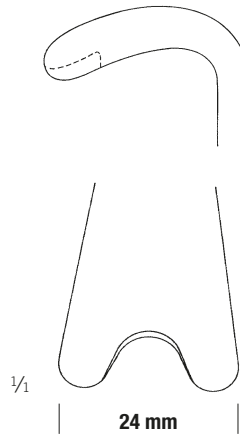
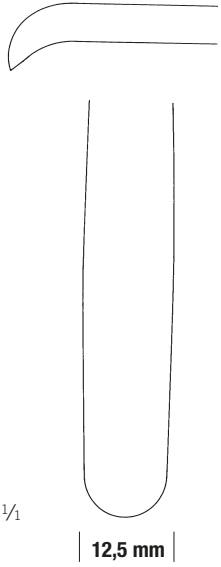
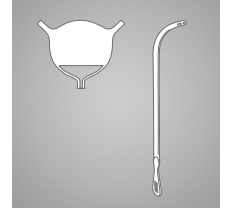
biegsamer Schaft, stumpf  
malleable shaft, blunt  
vástago maleable, romo  
tige malléable, mousse  
gambo malleabile, smusso

## Prostatahaken

Prostatic Retractors  
Separadores para próstata  
Ecarteurs prostatiques  
Divaricatori prostatici

## Urologie

Urology  
Urología  
Urologie  
Urologia



1/2

Young  
31-401-21-07  
22 cm / 8 5/8"



1/2

Young  
31-405-21-07  
22 cm / 8 4/8"



1/2

Young  
31-407-22-07  
23 cm / 9"

## Kapsel­f­ass­z­an­gen

Capsule Forceps

Pinzas capsulares

Pinces pour saisir les capsules

Pinze per afferrare capsule

**Atrauma**



Millin  
31-451-24-07  
24,5 cm / 9 5/8"

**Atrauma**



Millin  
31-453-24-07  
22,5 cm / 8 7/8"



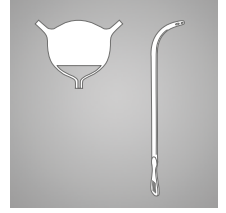
Millin  
31-461-23-07  
24,5 cm / 9 5/8"

## Kapselasszange

Capsule Forceps  
Pinzas capsulares  
Pinces pour saisir les capsules  
Pinze per afferrare capsule

## Urologie

Urology  
Urología  
Urologie  
Urologia



31



1/2

Millin  
31-463-23-07  
22 cm / 8 5/8"

## Blasenhalsperrer, Blasenwundsperrer

Bladder Neck Spreader, Bladder Retractors

Dilatador para el cuello vesical, Separadores vesicales

Ecarteur pour le col de la vessie, Ecarteurs vésicaux

Divaricatore del collo vescicale/Divaricatore vescicale



1/2

Millin  
31-475-00-07  
28 cm / 11"



70 mm



1/2

Judd-Masson  
31-510-00-07



120 mm

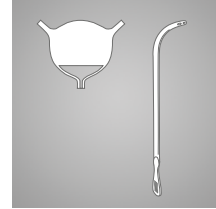
komplett, mit 1 paar Seiten-Valven sowie 1 Mittelvalve  
complete, with 1 pair of lateral blades and 1 central blade  
completo, con 1 par de valvas laterales y 1 valva central  
complet, avec 1 paire de valvas latérales et 1 valve centrale  
completo, con 1 pair di valve laterali e 1 valva centrale

## Blasenwundsperrer

Bladder Retractors  
Separadores vesicales  
Ecarteurs vésicaux  
Divaricatore vescicale

## Urologie

Urology  
Urología  
Urologie  
Urologia



31



1/2

### Millin

31-512-00-07

komplett, mit je 2 Seitenvalven  
57 x 25 mm und 80 x 25 mm, sowie  
einer 1 Mittelvalve 120 x 45 mm

complete, with 2 pairs of lateral  
blades 57 x 25 mm and 80 x 25 mm,  
and 1 central blade 120 x 45 mm

completo, con 2 pares de valvas  
laterales 57 x 25 mm y 80 x 25 mm y  
una valva central 120 x 45 mm

complet, avec 2 paires de valvas  
latérales 57 x 25 mm et 80 x 25 mm  
et 1 valve centrale 120 x 45 mm

completo, con 2 paia di valve laterali  
57 x 25 mm e 80 x 25 mm in più 1  
valva centrale 120 x 45 mm



**57 x 25 mm**  
31-512-90-98

Seitenvalven  
Lateral Blades  
Valvas laterales  
Valves laterales  
Valve laterali



**80 x 25 mm**  
31-512-91-98

Seitenvalven  
Lateral Blades  
Valvas laterales  
Valves laterales  
Valve laterali

**120 x 45 mm**  
31-512-92-98

Mittelvalve  
Central Blade  
Valva central  
Valve centrale  
Valva centrale

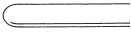
## Harnröhrenbougies

Urethral Sounds

Bujías uretrales

Bougies urétrales

Candelette dilatatrici

1/1 



1/2

### Van Buren

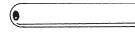
31-599-00-07 -  
31-599-36-07

27 cm / 10 5/8"

| Charrière | Van Buren    |
|-----------|--------------|
| 8         | 31-599-08-07 |
| 10        | 31-599-10-07 |
| 12        | 31-599-12-07 |
| 14        | 31-599-14-07 |
| 16        | 31-599-16-07 |
| 18        | 31-599-18-07 |
| 20        | 31-599-20-07 |
| 22        | 31-599-22-07 |
| 24        | 31-599-24-07 |
| 26        | 31-599-26-07 |
| 28        | 31-599-28-07 |
| 30        | 31-599-30-07 |
| 32        | 31-599-32-07 |
| 34        | 31-599-34-07 |
| 36        | 31-599-36-07 |

31-599-00-07

Satz komplett, 8 - 36 Charrière  
complete set, 8 - 36 Charrière  
juego completo, 8 - 36 Charrière  
jeu complet, 8 - 36 Charrière  
set completo, 8 - 36 Charrière

1/1 



1/2

### Guyon

31-607-10-07 -  
31-607-30-07

26,5 cm / 10 3/8"

| Charrière | Guyon        |
|-----------|--------------|
| 10        | 31-607-10-07 |
| 11        | 31-607-11-07 |
| 12        | 31-607-12-07 |
| 13        | 31-607-13-07 |
| 14        | 31-607-14-07 |
| 15        | 31-607-15-07 |
| 16        | 31-607-16-07 |
| 17        | 31-607-17-07 |
| 18        | 31-607-18-07 |
| 19        | 31-607-19-07 |
| 20        | 31-607-20-07 |
| 21        | 31-607-21-07 |
| 22        | 31-607-22-07 |
| 23        | 31-607-23-07 |
| 24        | 31-607-24-07 |
| 25        | 31-607-25-07 |
| 26        | 31-607-26-07 |
| 27        | 31-607-27-07 |
| 28        | 31-607-28-07 |
| 29        | 31-607-29-07 |
| 30        | 31-607-30-07 |

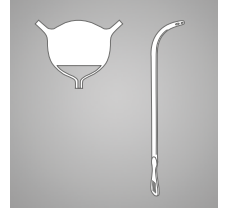


## Katheter

Catheters  
Sondas  
Sondes  
Sonde

## Urologie

Urology  
Urología  
Urologie  
Urologia



| Charrière |              |
|-----------|--------------|
| 12        | 31-721-12-01 |
| 14        | 31-721-14-01 |



1/2

31-721-12-01 -  
31-721-14-01

15 cm / 5 7/8"

Metallkatheter für Frauen  
Metal Catheters, female  
Sondas metálicas, femeninas  
Sondes métalliques, pour femmes  
Sonde metalliche, per donne

## Circumcisions-Instrumente

Circumcision Instruments

Instrumentos para circuncisión

Instruments pour circoncision

Strumenti per circoncisione



|              | Ø     |
|--------------|-------|
| 31-765-08-07 | 8 mm  |
| 31-765-11-07 | 11 mm |
| 31-765-13-07 | 13 mm |
| 31-765-16-07 | 16 mm |
| 31-765-21-07 | 21 mm |
| 31-765-26-07 | 26 mm |
| 31-765-32-07 | 32 mm |



31-765-08-07 -  
31-765-32-07

Circumcisionsgerät  
Circumcision Instrument  
Instrumento para circuncisión  
Instrument de circoncision  
Strumento per circoncisione

Mogen  
31-766-00-07

7,5 cm / 3 "

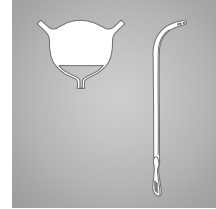
Beschneidungsinstrument  
Circumcision Instrument  
Instrumento para circuncisión  
Instrument de circoncision  
Strumento per circoncisione

## Fremdkörperzangen

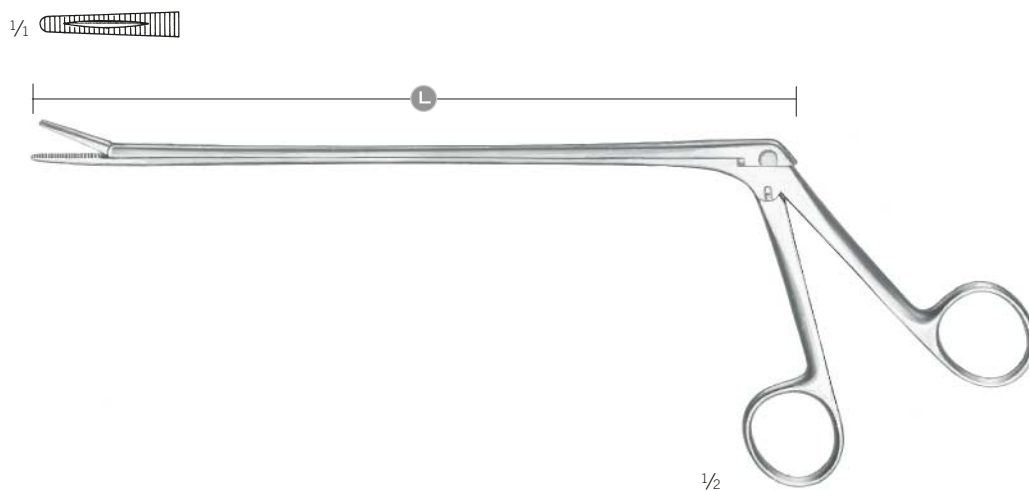
Foreign Body Forceps  
Pinzas para cuerpos extraños  
Pinces pour corps étrangers  
Pinze per corpi estranei

## Urologie

Urology  
Urología  
Urologie  
Urologia



31



Mathieu  
31-811-20-07

Schaftlänge  
shaft length  
longitud del vástago  
longueur de la tige  
lunghezza dell'asta

**200 mm**

Mathieu  
31-811-28-07

Schaftlänge  
shaft length  
longitud del vástago  
longueur de la tige  
lunghezza dell'asta

**300 mm**

## Penisklemmen

Penis Clamps  
Clamps para pene  
Pinces pour pénis  
Serrapene

---



1/2

Stockmann  
31-875-08-01  
8 cm / 3 1/8"



1/2

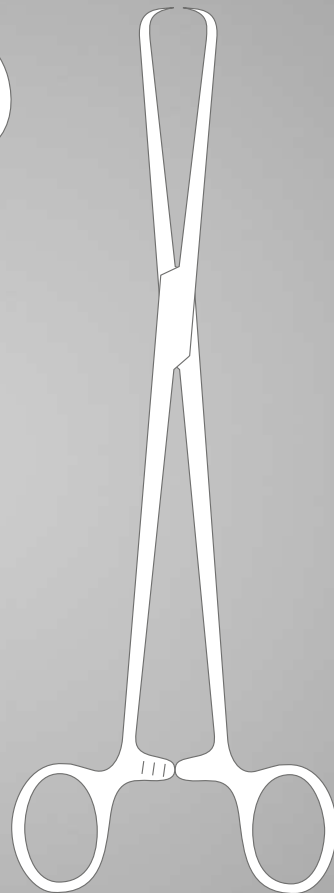
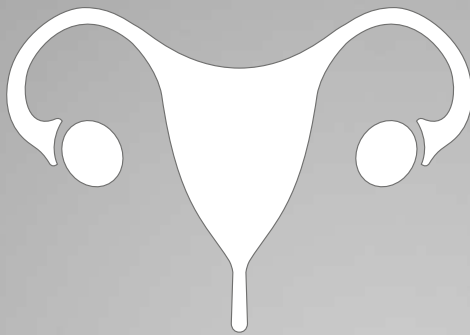
Strauss  
31-881-11-01  
11 cm / 4 3/8"

31-881-90-98

1 Paar Schläuche allein  
1 pair of flexible tubes only  
1 par de mangueras individuales  
1 paire de tubes flexibles, seuls  
1 coppia di tubi flessibili singoli

Gynäkologie  
Gynecology  
Ginecología  
Gynécologie  
Ginecologia

# 32



## Vaginalspekula

Vaginal Specula  
Espéculos vaginales  
Spéculums vaginaux  
Specoli vaginali



½

Cusco

|              |             |
|--------------|-------------|
| 32-110-01-01 | 75 x 32 mm  |
| 32-110-02-01 | 85 x 37 mm  |
| 32-110-03-01 | 100 x 35 mm |



½

Cusco

|              |            |
|--------------|------------|
| 32-112-01-01 | 75 x 18 mm |
|--------------|------------|



½

Cusco

|              |             |
|--------------|-------------|
| 32-114-01-01 | 90 x 22 mm  |
| 32-114-02-01 | 100 x 25 mm |
| 32-114-03-01 | 105 x 27 mm |



½

Cusco

|              |             |
|--------------|-------------|
| 32-116-01-01 | 75 x 34 mm  |
| 32-116-02-01 | 85 x 37 mm  |
| 32-116-03-01 | 100 x 37 mm |



½

Collin

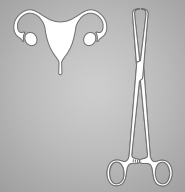
|              |             |
|--------------|-------------|
| 32-120-01-01 | 85 x 30 mm  |
| 32-120-02-01 | 100 x 35 mm |
| 32-120-03-01 | 110 x 40 mm |

## Vaginalspekula

Vaginal Specula  
Espéculos vaginales  
Spéculums vaginaux  
Specoli vaginali

## Gynäkologie

Gynecology  
Ginecología  
Gynécologie  
Ginecologia



32



1/2

Pederson

|              |             |
|--------------|-------------|
| 32-128-01-01 | 75 x 13 mm  |
| 32-128-02-01 | 100 x 24 mm |
| 32-128-03-01 | 120 x 26 mm |



1/2

Grave

|              |             |
|--------------|-------------|
| 32-130-01-01 | 75 x 20 mm  |
| 32-130-02-01 | 95 x 35 mm  |
| 32-130-03-01 | 115 x 35 mm |



1/2

Semm

|              |                |
|--------------|----------------|
| 32-132-01-01 | 100 x 20-25 mm |
| 32-132-02-01 | 100 x 27-35 mm |



1/2

Guttman

|              |            |
|--------------|------------|
| 32-133-01-07 | 90 x 35 mm |
|--------------|------------|

## Vaginalspekula, Scheidenhalter

Vaginal Specula, Vaginal Retractors

Espéculos vaginales, Valvas vaginales

Spéculums vaginaux, Valves vaginales

Specoli vaginali, Valve vaginali



1/2

Sims

|              |                         |
|--------------|-------------------------|
| 32-160-01-01 | 65 x 25 mm / 70 x 30 mm |
| 32-160-02-01 | 70 x 30 mm / 80 x 35 mm |
| 32-160-03-01 | 85 x 35 mm / 90 x 40 mm |



1/2

Jackson

|              |             |
|--------------|-------------|
| 32-165-01-07 | 75 x 38 mm  |
| 32-165-02-07 | 90 x 38 mm  |
| 32-165-03-07 | 100 x 38 mm |

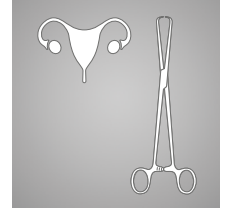


## Vaginalspekula, Scheidenhalter

Vaginal Specula, Vaginal Retractors  
Espéculos vaginales, Valvas vaginales  
Spéculums vaginaux, Valves vaginales  
Specoli vaginali, Valve vaginali

## Gynäkologie

Gynecology  
Ginecología  
Gynécologie  
Ginecologia



1/2

Kristeller

|              |               |                   |
|--------------|---------------|-------------------|
| 32-182-01-01 | <b>Fig. 1</b> | <b>70 x 27 mm</b> |
| 32-182-02-01 | <b>Fig. 2</b> | <b>80 x 30 mm</b> |
| 32-182-03-01 | <b>Fig. 3</b> | <b>90 x 36 mm</b> |



1/2

Kristeller

|              |               |                    |
|--------------|---------------|--------------------|
| 32-183-01-01 | <b>Fig. 1</b> | <b>75 x 23 mm</b>  |
| 32-183-02-01 | <b>Fig. 2</b> | <b>85 x 26 mm</b>  |
| 32-183-03-01 | <b>Fig. 3</b> | <b>100 x 32 mm</b> |



1/2

Kristeller

|              |               |                               |
|--------------|---------------|-------------------------------|
| 32-185-01-01 | <b>Fig. 1</b> | (32-182-01-01 & 32-183-01-01) |
| 32-185-02-01 | <b>Fig. 2</b> | (32-182-02-01 & 32-183-02-01) |
| 32-185-03-01 | <b>Fig. 3</b> | (32-182-03-01 & 32-183-03-01) |

## Vaginalspekula, Scheidenhalter

Vaginal Specula, Vaginal Retractors

Espéculos vaginales, Valvas vaginales

Spéculums vaginaux, Valves vaginales

Specoli vaginali, Valve vaginali



½

Kristeller

|              |               |                    |
|--------------|---------------|--------------------|
| 32-190-01-01 | <b>Fig. 1</b> | <b>105 x 18 mm</b> |
| 32-190-02-01 | <b>Fig. 2</b> | <b>105 x 21 mm</b> |



½

Kristeller

|              |               |                    |
|--------------|---------------|--------------------|
| 32-191-01-01 | <b>Fig. 1</b> | <b>110 x 14 mm</b> |
| 32-191-02-01 | <b>Fig. 2</b> | <b>110 x 17 mm</b> |



½

Kristeller

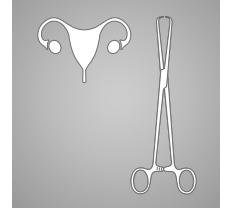
|                               |               |
|-------------------------------|---------------|
| 32-195-01-01                  | <b>Fig. 1</b> |
| (32-190-01-01 & 32-191-01-01) |               |
| 32-195-02-01                  | <b>Fig. 2</b> |
| (32-190-02-01 & 32-191-02-01) |               |

## Vaginalspekula, Scheidenhalter

Vaginal Specula, Vaginal Retractors  
 Espéculos vaginales, Valvas vaginales  
 Spéculums vaginaux, Valves vaginales  
 Specoli vaginali, Valve vaginali

## Gynäkologie

Gynecology  
 Ginecología  
 Gynécologie  
 Ginecologia



flaches Spekulum  
 flat speculum  
 espéculo plano  
 spéculum plat  
 specolo piatto



1/2

Kristeller

|              |               |                    |
|--------------|---------------|--------------------|
| 32-196-01-01 | <b>Fig. 1</b> | <b>105 x 26 mm</b> |
| 32-196-02-01 | <b>Fig. 2</b> | <b>105 x 28 mm</b> |
| 32-196-03-01 | <b>Fig. 3</b> | <b>105 x 33 mm</b> |



1/2

Kristeller

|              |               |                    |
|--------------|---------------|--------------------|
| 32-197-01-01 | <b>Fig. 1</b> | <b>115 x 22 mm</b> |
| 32-197-02-01 | <b>Fig. 2</b> | <b>115 x 24 mm</b> |
| 32-197-03-01 | <b>Fig. 3</b> | <b>115 x 29 mm</b> |



1/2

Kristeller

|              |               |                               |
|--------------|---------------|-------------------------------|
| 32-199-01-01 | <b>Fig. 1</b> | (32-196-01-01 & 32-197-01-01) |
| 32-199-02-01 | <b>Fig. 2</b> | (32-196-02-01 & 32-197-02-01) |
| 32-199-03-01 | <b>Fig. 3</b> | (32-196-03-01 & 32-197-03-01) |

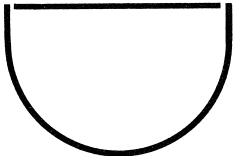
## Vaginalspekula, Scheidenhalter

Vaginal Specula, Vaginal Retractors

Espéculos vaginales, Valvas vaginales

Spéculums vaginaux, Valves vaginales

Specoli vaginali, Valve vaginali



tiefes Spekulum  
deep speculum  
espéculo profundo  
spéculum profond  
specolo profondo



1/2

Kristeller

|              |               |                    |
|--------------|---------------|--------------------|
| 32-202-01-01 | <b>Fig. 1</b> | <b>110 x 28 mm</b> |
| 32-202-02-01 | <b>Fig. 2</b> | <b>110 x 30 mm</b> |
| 32-202-03-01 | <b>Fig. 3</b> | <b>110 x 36 mm</b> |



1/2

Kristeller

|              |               |                    |
|--------------|---------------|--------------------|
| 32-203-01-01 | <b>Fig. 1</b> | <b>115 x 23 mm</b> |
| 32-203-02-01 | <b>Fig. 2</b> | <b>115 x 26 mm</b> |
| 32-203-03-01 | <b>Fig. 3</b> | <b>115 x 32 mm</b> |



1/2

Kristeller

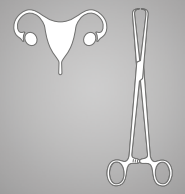
|              |               |                               |
|--------------|---------------|-------------------------------|
| 32-205-01-01 | <b>Fig. 1</b> | (32-202-01-01 & 32-203-01-01) |
| 32-205-02-01 | <b>Fig. 2</b> | (32-202-02-01 & 32-203-02-01) |
| 32-205-03-01 | <b>Fig. 3</b> | (32-202-03-01 & 32-203-03-01) |

## Vaginalspekula, Scheidenhalter

Vaginal Specula, Vaginal Retractors  
Espéculos vaginales, Valvas vaginales  
Spéculums vaginaux, Valves vaginales  
Specoli vaginali, Valve vaginali

## Gynäkologie

Gynecology  
Ginecología  
Gynécologie  
Ginecologia



1/2

Kallmorgen

|              |               |                   |
|--------------|---------------|-------------------|
| 32-232-01-01 | <b>Fig. 1</b> | <b>70 x 40 mm</b> |
| 32-232-02-01 | <b>Fig. 2</b> | <b>90 x 40 mm</b> |



1/2

Kallmorgen

|              |               |                   |
|--------------|---------------|-------------------|
| 32-233-01-01 | <b>Fig. 1</b> | <b>70 x 37 mm</b> |
| 32-233-02-01 | <b>Fig. 2</b> | <b>90 x 37 mm</b> |



1/2

Kallmorgen

|              |               |                               |
|--------------|---------------|-------------------------------|
| 32-235-01-01 | <b>Fig. 1</b> | (32-232-01-01 & 32-233-01-01) |
| 32-235-02-01 | <b>Fig. 2</b> | (32-232-02-01 & 32-233-02-01) |

## Vaginalspekula, Scheidenhalter

Vaginal Specula, Vaginal Retractors  
Espéculos vaginales, Valvas vaginales  
Spéculums vaginaux, Valves vaginales  
Specoli vaginali, Valve vaginali



1/2

### Doyen

|              |             |
|--------------|-------------|
| 32-249-01-01 | 58 x 35 mm  |
| 32-249-02-01 | 88 x 35 mm  |
| 32-249-03-01 | 118 x 35 mm |

|              |             |
|--------------|-------------|
| 32-250-01-01 | 60 x 47 mm  |
| 32-250-02-01 | 95 x 47 mm  |
| 32-250-03-01 | 120 x 47 mm |
| 32-250-04-01 | 165 x 47 mm |

|              |             |
|--------------|-------------|
| 32-251-01-01 | 55 x 60 mm  |
| 32-251-02-01 | 85 x 60 mm  |
| 32-251-03-01 | 115 x 60 mm |

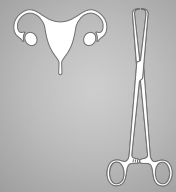
|              |             |
|--------------|-------------|
| 32-252-01-01 | 160 x 60 mm |
| 32-252-02-01 | 200 x 60 mm |

## Vaginalspekula, Scheidenhalter

Vaginal Specula, Vaginal Retractors  
Especúlos vaginales, Valvas vaginales  
Spéculums vaginaux, Valves vaginales  
Specoli vaginali, Valve vaginali

## Gynäkologie

Gynecology  
Ginecología  
Gynécologie  
Ginecologia



1/2

### Scherbak

Blatt, allein  
Specula Blade, only  
Valva vaginal, suelta  
Valve vaginale, seule  
Valve vaginale, sola

1/1

80 x 30 mm  
32-302-01-01

➔ 32-302-14-07

85 x 35 mm  
32-302-02-01

➔ 32-302-14-07

90 x 40 mm  
32-302-03-01

➔ 32-302-14-07

32



1/2

### Scherbak

Blatt, allein  
Specula Blade, only  
Valva vaginal, suelta  
Valve vaginale, seule  
Valve vaginale, sola

58 x 40 - 60 mm  
32-302-04-01

➔ 32-302-14-07

70 x 45 - 70 mm  
32-302-05-01

➔ 32-302-14-07



Handgriff siehe Seite 610  
Handle see page 610  
Mango consulte la página 610  
Manche voir page 610  
Manico vedi pagina 610

## Vaginalspekula

Vaginal Specula  
Espéculos vaginales  
Spéculums vaginaux  
Specoli vaginali

### Scherbak

32-302-00-01

Satz komplett mit Griff, Gewicht (400 g) und 5 Blättern  
complete set with handle, weight (400 g) and 5 blades  
juego completo con mango, peso (400 g) y 5 valvas  
jeu complet avec manche, poids (400 g) et 5 valves  
Set completo con manico, peso (400 g) e 5 valve



**Blätter siehe Seite 609**  
**Blades see page 609**  
**Valve consulte la página 609**  
**Valves voir page 609**  
**Valvi vedi pagina 609**



1/2

1/3



1/3



### Scherbak

32-302-10-01

10,5 cm / 4 " / 400 g

Gewicht zum Vaginalspekulum  
Weight for Vaginal Speculum  
Peso para espéculo vaginal  
Poids pour spéculum vaginal  
Peso per specolo vaginale

### Scherbak

32-302-12-01

13 cm / 5 " / 800 g

Gewicht zum Vaginalspekulum  
Weight for Vaginal Speculum  
Peso para espéculo vaginal  
Poids pour spéculum vaginal  
Peso per specolo vaginale

### Scherbak

32-302-14-07

20 cm / 7 7/8"

Griff zum Vaginalspekulum  
Handle for Vaginal Speculum  
Mango para espéculo vaginal  
Manche pour spéculum vaginal  
Manico per specolo vaginale

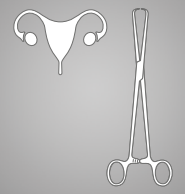


## Vaginalspekula

Vaginal Specula  
Espéculos vaginales  
Spéculums vaginaux  
Specoli vaginali

## Gynäkologie

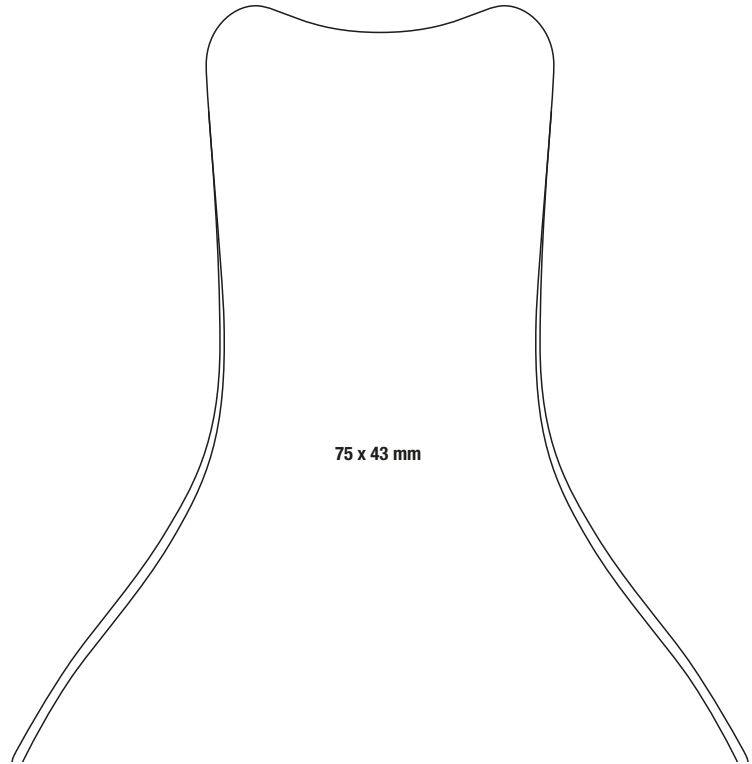
Gynecology  
Ginecología  
Gynécologie  
Ginecologia



32



1/1



75 x 43 mm

32-310-90-98

Gewicht allein  
Weight only  
Peso suelta  
Poids seul  
Peso solo

**1 Kg**

1/2

Auvar  
32-310-22-01  
23,5 cm / 9 2/8"

komplett, mit abnehmbarem Gewicht  
complete, with detachable weight  
completo, con peso desmontable  
complet, avec poids démontable  
completo, con peso smontabile

## Vaginalspekula, Scheidenhalter

Vaginal Specula, Vaginal Retractors

Espécules vaginales, Valvas vaginales

Spéculums vaginaux, Valves vaginales

Specoli vaginali, Valve vaginali



80 x 42 mm

1/2

**Weissbarth**  
32-314-24-02

21 cm / 8 2/8"

komplett, mit abnehmbarem Auffangsieb  
complete, with detachable strainer  
completo, con tamiz desmontable  
complet, avec tamis démontable  
completo, con crivello smontabile

32-314-99-02

Auffangsieb  
Strainer for Vaginal Speculum  
Tamiz para espéculo vaginal  
Tamis pour spéculum vaginal  
Crivello per specola vaginale



32-314-24-02



1/1

1/2

**Breisky**  
32-323-20-07 -  
32-325-40-07

|              |             |                   |
|--------------|-------------|-------------------|
| 32-323-20-07 | 100 x 20 mm | 29,5 cm / 11 5/8" |
| 32-323-25-07 | 100 x 25 mm | 29,5 cm / 11 5/8" |
| 32-323-30-07 | 100 x 30 mm | 29,5 cm / 11 5/8" |
| 32-323-35-07 | 100 x 35 mm | 29,5 cm / 11 5/8" |
| 32-323-40-07 | 100 x 40 mm | 29,5 cm / 11 5/8" |

|              |             |                 |
|--------------|-------------|-----------------|
| 32-324-20-07 | 130 x 20 mm | 32 cm / 12 5/8" |
| 32-324-25-07 | 130 x 25 mm | 32 cm / 12 5/8" |
| 32-324-30-07 | 130 x 30 mm | 32 cm / 12 5/8" |
| 32-324-35-07 | 130 x 35 mm | 32 cm / 12 5/8" |
| 32-324-40-07 | 130 x 40 mm | 32 cm / 12 5/8" |

|              |             |                 |
|--------------|-------------|-----------------|
| 32-325-40-07 | 160 x 40 mm | 35 cm / 13 6/8" |
|--------------|-------------|-----------------|



70 x 30 mm

1/2

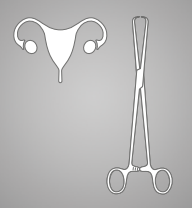
**Doyen**  
32-342-24-01  
25 cm / 9 7/8"

## Endospekula

Endocervical Specula  
Espéculos endocervicales  
Endospéculums  
Endospecoli

## Gynäkologie

Gynecology  
Ginecología  
Gynécologie  
Ginecologia



1/2

Kogan  
32-381-24-07  
24,5 cm / 9 5/8"



1/2

Kogan  
32-383-24-07  
24,5 cm / 9 5/8"

## Uterusdilatatoren

Uterine Dilators

Dilatadores uterinos

Dilateurs du col de l'utérus

Dilatatori uterini



1/2

Hegar

32-400-01-01 -

32-401-17-01

18,5 cm / 7 2/8"

| mm Ø |              |              |
|------|--------------|--------------|
| 1,0  | 32-400-01-01 |              |
| 1,5  |              | 32-401-01-01 |
| 2,0  | 32-400-02-01 |              |
| 2,5  |              | 32-401-02-01 |
| 3,0  | 32-400-03-01 |              |
| 3,5  |              | 32-401-03-01 |
| 4,0  | 32-400-04-01 |              |
| 4,5  |              | 32-401-04-01 |
| 5,0  | 32-400-05-01 |              |
| 5,5  |              | 32-401-05-01 |
| 6,0  | 32-400-06-01 |              |
| 6,5  |              | 32-401-06-01 |
| 7,0  | 32-400-07-01 |              |
| 7,5  |              | 32-401-07-01 |
| 8,0  | 32-400-08-01 |              |
| 8,5  |              | 32-401-08-01 |
| 9,0  | 32-400-09-01 |              |
| 9,5  |              | 32-401-09-01 |
| 10,0 | 32-400-10-01 |              |
| 10,5 |              | 32-401-10-01 |
| 11,0 | 32-400-11-01 |              |
| 11,5 |              | 32-401-11-01 |
| 12,0 | 32-400-12-01 |              |
| 12,5 |              | 32-401-12-01 |
| 13,0 | 32-400-13-01 |              |
| 13,5 |              | 32-401-13-01 |
| 14,0 | 32-400-14-01 |              |
| 14,5 |              | 32-401-14-01 |
| 15,0 | 32-400-15-01 |              |
| 15,5 |              | 32-401-15-01 |
| 16,0 | 32-400-16-01 |              |
| 16,5 |              | 32-401-16-01 |
| 17,0 | 32-400-17-01 |              |
| 17,5 |              | 32-401-17-01 |
| 18,0 | 32-400-18-01 |              |
| 19,0 | 32-400-19-01 |              |
| 20,0 | 32-400-20-01 |              |
| 21,0 | 32-400-21-01 |              |
| 22,0 | 32-400-22-01 |              |
| 23,0 | 32-400-23-01 |              |
| 24,0 | 32-400-24-01 |              |
| 25,0 | 32-400-25-01 |              |
| 26,0 | 32-400-26-01 |              |

### 32-400-80-01

Satz mit 14 Stück (ganze Größen) von 4,0 bis 17,0 mm **ohne Etui**

set of 14 pieces (full sizes) from 4,0 to 17,0 mm **without case**

juego de 14 piezas (tamaños enteros) de 4,0 a 17,0 mm **sin caja**

jeu de 14 pièces (taille entière) de 4,0 jusqu'à 17,0 mm **sans boîte**

serie di 14 pezzi (grandezza intera) da 4,0 fino a 17,0 mm **senza scatola**

### 32-400-90-01

Satz mit 26 Stück (ganze Größen) von 1,0 bis 26,0 mm **ohne Etui**

set of 26 pieces (full sizes) from 1,0 to 26,0 mm **without case**

juego de 26 piezas (tamaños enteros) de 1,0 a 26,0 mm **sin caja**

jeu de 26 pièces (taille entière) de 1,0 jusqu'à 26,0 mm **sans boîte**

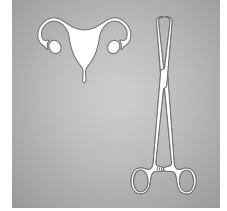
serie di 26 pezzi (grandezza intera) da 1,0 fino a 26,0 mm **senza scatola**

## Uterusdilatoren

Uterine Dilators  
Dilatadores uterinos  
Dilatateurs du col de l'utérus  
Dilatatori uterini

## Gynäkologie

Gynecology  
Ginecología  
Gynécologie  
Ginecologia



| mm Ø        |              |
|-------------|--------------|
| 1,0 / 2,0   | 32-430-02-01 |
| 3,0 / 4,0   | 32-430-04-01 |
| 5,0 / 6,0   | 32-430-06-01 |
| 7,0 / 8,0   | 32-430-08-01 |
| 9,0 / 10,0  | 32-430-10-01 |
| 11,0 / 12,0 | 32-430-12-01 |
| 13,0 / 14,0 | 32-430-14-01 |
| 15,0 / 16,0 | 32-430-16-01 |
| 17,0 / 18,0 | 32-430-18-01 |
| 19,0 / 20,0 | 32-430-20-01 |
| 21,0 / 22,0 | 32-430-22-01 |
| 23,0 / 24,0 | 32-430-24-01 |
| 25,0 / 26,0 | 32-430-26-01 |

1/2

Hegar  
32-430-02-01 -  
32-430-26-01  
20 cm / 7 7/8"

### 32-430-80-01

Satz mit 8 Stück von 3,0 / 4,0 bis 17,0 / 18,0 mm **ohne Etui**  
set of 8 pieces from 3,0 / 4,0 to 17,0 / 18,0 mm **without case**  
juego de 8 piezas de 3,0 / 4,0 a 17,0 / 18,0 mm **sin caja**  
jeu de 8 pièces de 3,0 / 4,0 jusqu'à 17,0 / 18,0 mm **sans boîte**  
serie di 8 pezzi da 3,0 / 4,0 fino a 17,0 / 18,0 mm **senza scatola**

## Uterusdilatoren

Uterine Dilators

Dilatadores uterinos

Dilatateurs du col de l'utérus

Dilatatori uterini



### Hegar

32-430-82-01

Satz mit 8 Stück von 3,0 / 4,0 bis 17,0 / 18,0 mm in  
auskochbarer Stoffrolltasche

set of 8 pieces from 3,0 / 4,0 to 17,0 / 18,0 mm  
in boilable canvas roll

juego de 8 piezas de 3,0 / 4,0 a 17,0 / 18,0 mm en  
bolsa de tela esterilizable por ebullición

jeu de 8 pièces de 3,0 / 4,0 jusqu'à 17,0 / 18,0 mm  
en pochette en treillis stérilisable par ébullition

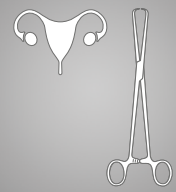
serie di 8 pezzi di 3,0 / 4,0 jusqu'à 17,0 / 18,0 mm  
in busta di tela sterilizzabile

## Uterusdilatoren

Uterine Dilators  
Dilatadores uterinos  
Dilatateurs du col de l'utérus  
Dilatatori uterini

## Gynäkologie

Gynecology  
Ginecología  
Gynécologie  
Ginecologia



32



1/2

Hank  
32-460-10-01 -  
32-460-20-01

26,5 cm / 10 <sup>3</sup>/<sub>8</sub>"

amerikanische Skala  
American scale  
escala americana  
échelle américaine  
scala americana

|              | Fig.    | mm Ø       |
|--------------|---------|------------|
| 32-460-10-01 | 9 / 10  | 4,5 / 5,0  |
| 32-460-12-01 | 11 / 12 | 5,5 / 6,0  |
| 32-460-14-01 | 13 / 14 | 6,5 / 7,0  |
| 32-460-16-01 | 15 / 16 | 7,5 / 8,0  |
| 32-460-18-01 | 17 / 18 | 8,5 / 9,0  |
| 32-460-20-01 | 19 / 20 | 9,5 / 10,0 |



Hank  
32-460-82-01

Satz mit 6 Stück in auskochbarer  
Stoffrolltasche

set of 6 piezas in boilable canvas roll

juego de 6 piezas en bolsa de tela  
esterilizable por ebullición

jeu de 6 pièces en pochette en treillis  
stérilisable par ébullition

serie di 6 pezzi in busta di tela  
sterilizzabile

## Uterussonden, Uterusdepressor

Uterine Sounds, Uterine Depressor

Histerómetros, Depresor uterino

Hystéromètres, Dépresseur utérin

Isterometri, Depressore uterino

Cr

Ø 4 mm



1/2

Sims  
32-583-32-01  
33 cm / 13"  
starr  
rigid  
rigido  
rigide  
rigido

Ø 4 mm



1/2

Sims  
32-584-32-02  
33 cm / 13"  
biegsam  
malleable  
maleable  
malléable  
malleabile

Ø 4 mm



1/2

Valleix  
32-593-25-01  
25,5 cm / 10"



1/2

Braun  
32-595-26-07  
27 cm / 10 5/8"



## Hakenzangen, Amniotom

Uterine Tenaculum Forceps, Amniotome

Pinza para cuello uterino, Amniótomo

Pince pour le col de l'utérus, Amniotome

Pinza per il collo dell'utero, Amniotomo

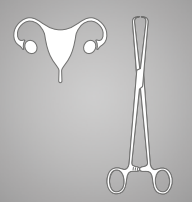
## Gynäkologie

Gynecology

Ginecología

Gynécologie

Ginecologia



1/2

Schröder  
32-622-25-07  
25,5 cm / 10"



1:1



1/2

Braun  
32-628-25-07  
26 cm / 10 2/8"



1:1



1/2

Duplay  
32-645-28-07  
28 cm / 11 "



1:1



1/2

Beacham  
32-659-26-07  
26 cm / 10 2/8"

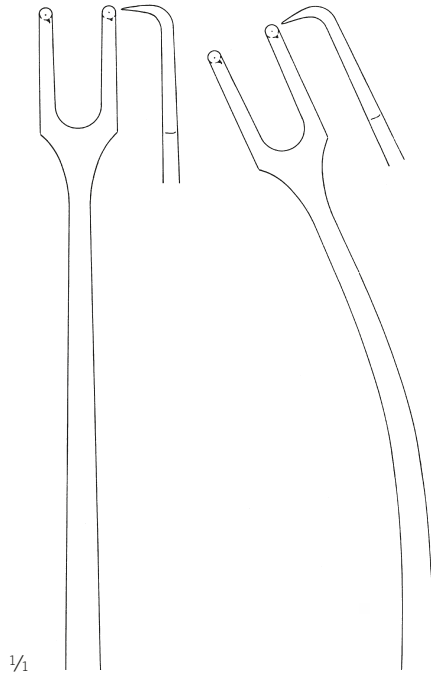
## Hakenzangen

Uterine Tenaculum Forceps

Pinza para cuello uterino

Pince pour le col de l'utérus

Pinza per il collo dell'utero



32-682-24-07

32-683-24-07



1/2

Skene  
32-663-24-07  
24 cm / 9 4/8"



1:1



1/2

Schröder  
32-682-24-07 -  
32-683-24-07  
25 cm / 9 7/8"



2:2



1/2

Teale  
32-697-23-07  
23 cm / 9"



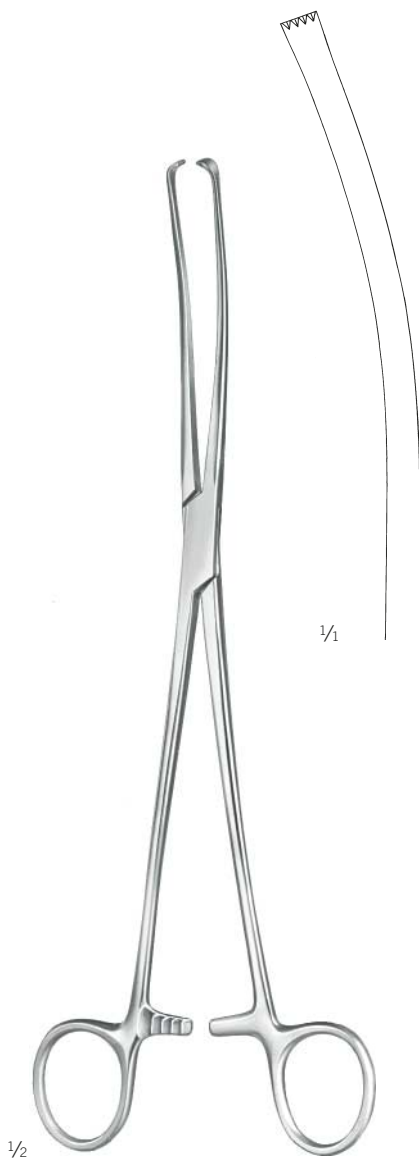
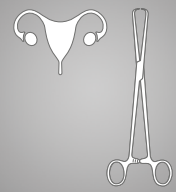
4:5

## Hakenzangen

Uterine Tenaculum Forceps  
Pinza para cuello uterino  
Pince pour le col de l'utérus  
Pinza per il collo dell'utero

## Gynäkologie

Gynecology  
Ginecología  
Gynécologie  
Ginecologia



1/2

Iowa  
32-699-26-07  
26 cm / 10 3/8"



5:6



1/2

Museux  
32-702-24-07 -  
32-706-24-07  
24 cm / 9 4/8"



2:2



1/2

Jacobs  
32-728-21-07  
21 cm / 8 3/8"



2:2

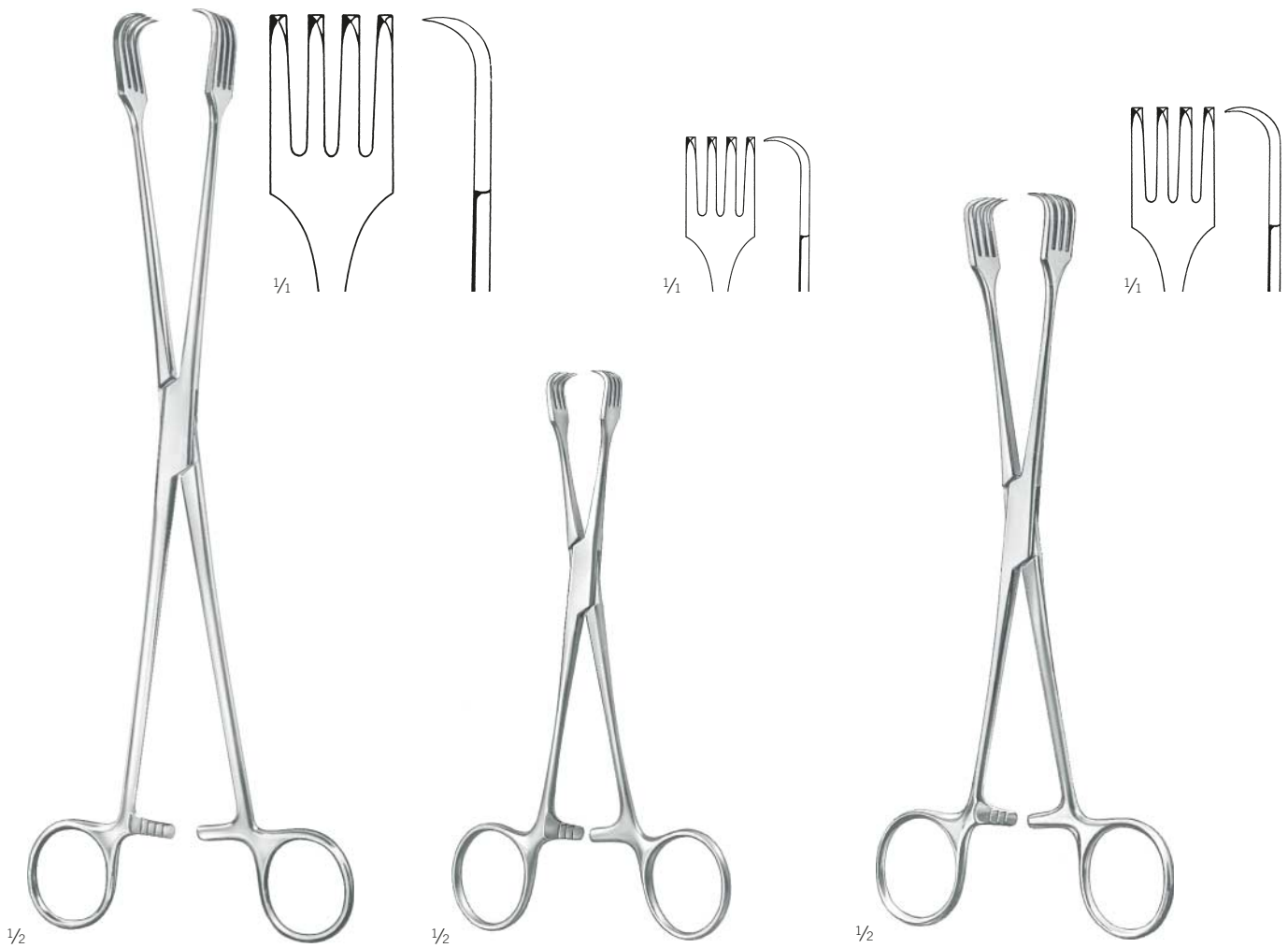
## Hakenzangen

Uterine Tenaculum Forceps

Pinza para cuello uterino

Pince pour le col de l'utérus

Pinza per il collo dell'utero



1/2

1/2

1/2

32-734-26-07  
26,5 cm / 10 3/8"

Braun  
32-738-16-07  
16 cm / 6 2/8"

Czerny  
32-740-21-07  
21 cm / 8 2/8"

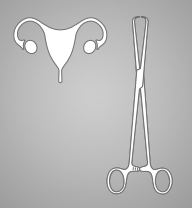


## Uterus-Polypenzangen

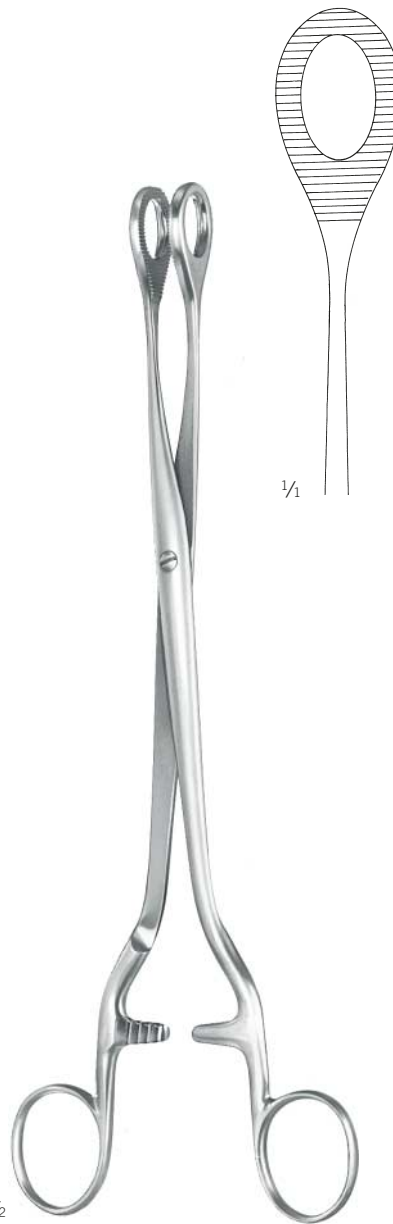
Uterine Polypus Forceps  
Pinzas para pólipos uterinos  
Pincas à polypes utérins  
Pinze per polipi uterini

## Gynäkologie

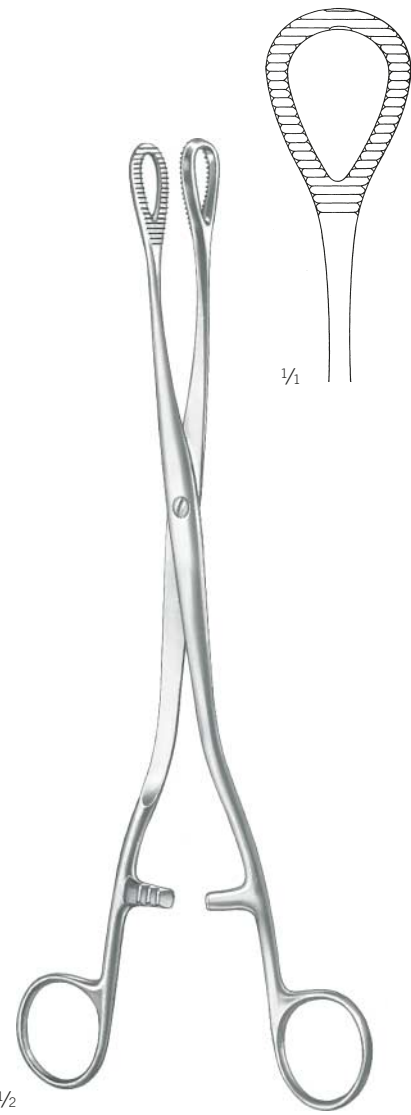
Gynecology  
Ginecología  
Gynécologie  
Ginecologia



Kelly  
32-741-32-07  
31,5 cm / 12  $\frac{3}{8}$ "



Noto  
32-744-27-07  
27 cm / 10  $\frac{5}{8}$ "



Heywood-Smith  
32-745-25-07  
26 cm / 10  $\frac{2}{8}$ "

## Myomheber, Myommesser

Myoma Screws, Myoma Knife

Tirabuzones para fibroma, Cuchillo para fibroma

Tracteurs pour fibromes, Evideur de fibromes

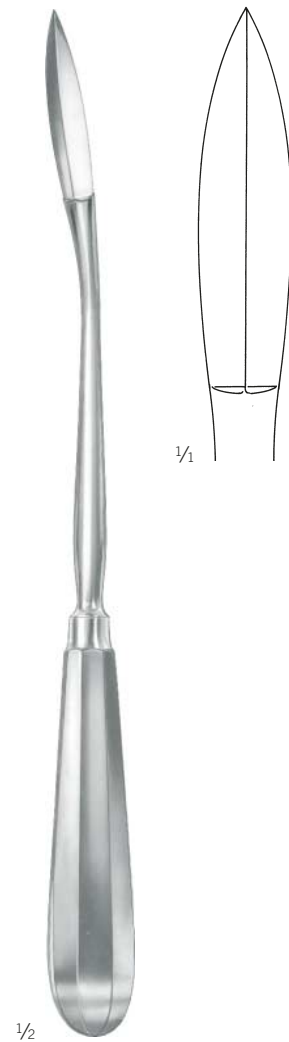
Tiramiomi, Bisturi per fibromi



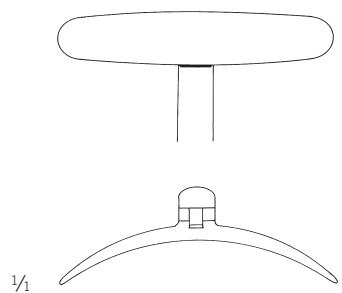
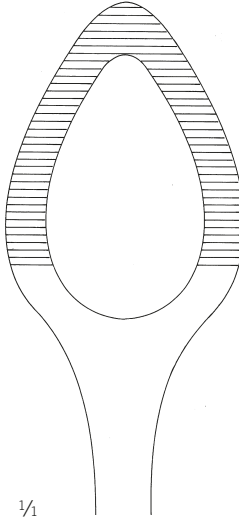
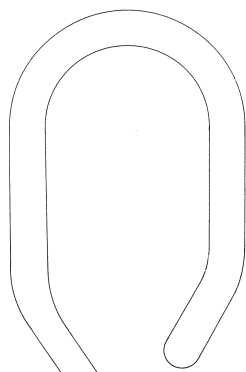
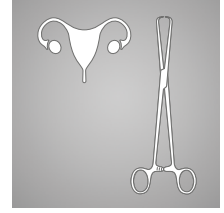
Doyen  
32-758-17-07  
17 cm / 6 6/8"



Doyen  
32-760-17-07  
15 cm / 5 7/8"



Segond  
32-762-27-07  
28 cm / 11 "



$\frac{1}{2}$   
**Dartigues**  
 32-773-27-07  
 27 cm / 10  $\frac{5}{8}$ "

$\frac{1}{2}$   
**Somer**  
 32-779-23-07  
 22,5 cm / 8  $\frac{7}{8}$ "

$\frac{1}{2}$   
**Collin**  
 32-793-25-07  
 26 cm / 10  $\frac{2}{8}$ "

## Fistelhaken

Fistula Hooks

Ganchos para fístulas

Crochets pour fistules

Uncini per fistole



Emmett  
32-804-03-07  
23 cm / 9 "



Simon  
32-806-22-07  
21,5 cm / 8 4/8 "



## Saugküretten, Biopsieküretten

Suction Curettes

Curetas aspiradoras

Curettes à aspiration

Curette d'aspirazione

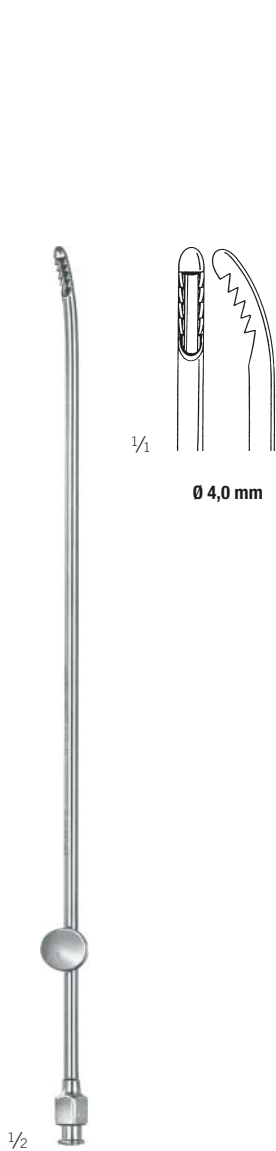
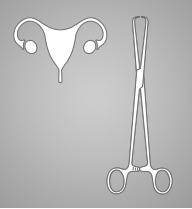
## Gynäkologie

Gynecology

Ginecología

Gynécologie

Ginecologia



Novak  
32-825-23-01  
24,5 cm / 9 5/8"

mit Luer-Lock Ansatz  
with Luer-Lock connection  
con conexión Luer-Lock  
avec connection Luer-Lock  
con raccordo Luer-Lock



Kevorkian  
32-827-30-07  
30 cm / 11 5/8"



Mod. München  
32-829-27-07  
27 cm / 10 5/8"

## Probeexzisionszangen

Uterine Biopsy Forceps

Pinzas para biopsia

Pinces pour biopsie

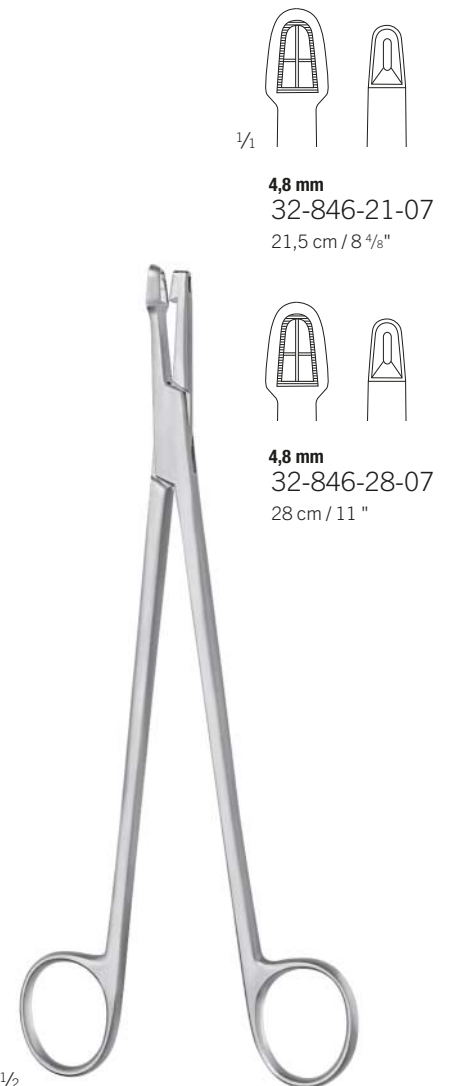
Pinze per biopsia



Gellhorn  
32-841-23-07  
24 cm / 9 4/8"



Faure  
32-843-21-07  
21 cm / 8 3/8"



Schubert  
32-846-21-07 -  
32-846-28-07

## Probeexzisionszangen

Uterine Biopsy Forceps

Pinzas para biopsia

Pinces pour biopsie

Pinze per biopsia

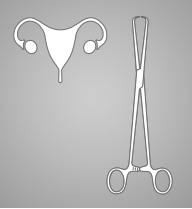
## Gynäkologie

Gynecology

Ginecología

Gynécologie

Ginecologia



1/2

Thoms-Gaylor  
32-851-22-07 -  
32-851-24-07



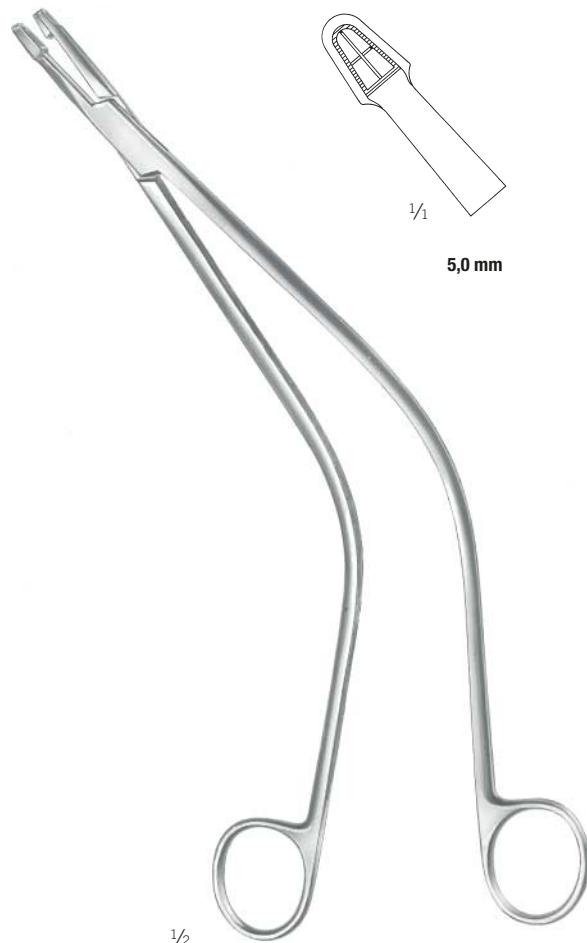
1/1



**Ø 5,6 mm**  
32-851-22-07  
21 cm / 8 2/8"

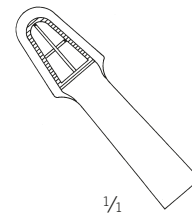


**Ø 5,6 mm**  
32-851-24-07  
24 cm / 9 4/8"



1/2

Schubert  
32-853-26-07  
24 cm / 9 4/8"



1/1

**5,0 mm**

## Probeexzisionszangen

Uterine Biopsy Forceps

Pinzas para biopsia

Pinces pour biopsie

Pinze per biopsia



Van Doren  
32-855-24-07  
27 cm / 10 5/8"



Van Doren  
32-855-25-07  
25,5 cm / 10 "

## Probeexzisionszangen

Uterine Biopsy Forceps

Pinzas para biopsia

Pinces pour biopsie

Pinze per biopsia

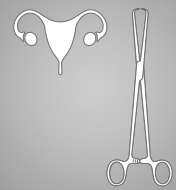
## Gynäkologie

Gynecology

Ginecología

Gynécologie

Ginecologia

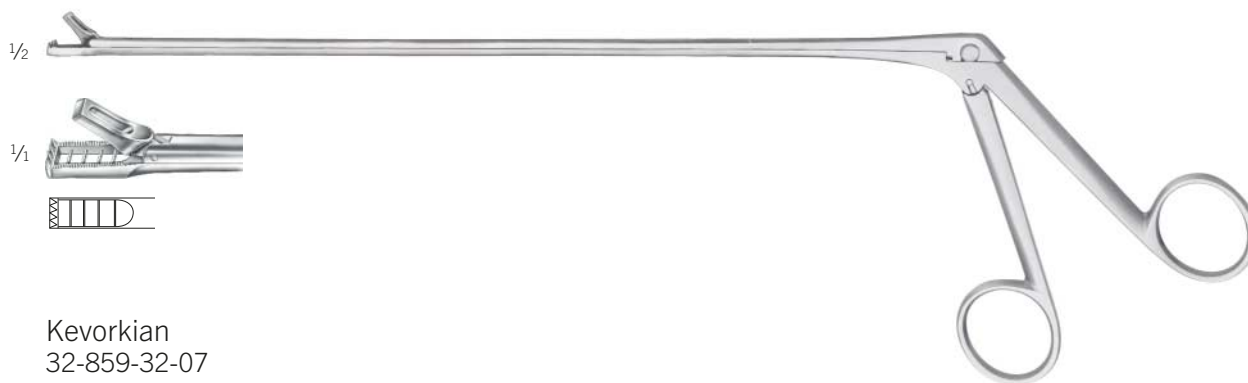


Alexander  
32-857-28-07

retrograder Schnitt, Maul nach links gebogen, geeignet für Kolposkopie  
retrograde cutting, jaws curved to left, suitable als in colposcopy  
corte retrograde, boca curva hacia izquierda, utilizable en colposcopia  
coupe retrograde, mors courbé vers gauche, approprié pour colposcopie  
filo retrogrado, morso curvato verso, adatto per colposcopia

Schaftlänge  
shaft length  
longitud del vástago  
longueur de la tige  
lunghezza dell'asta  
**195 mm**

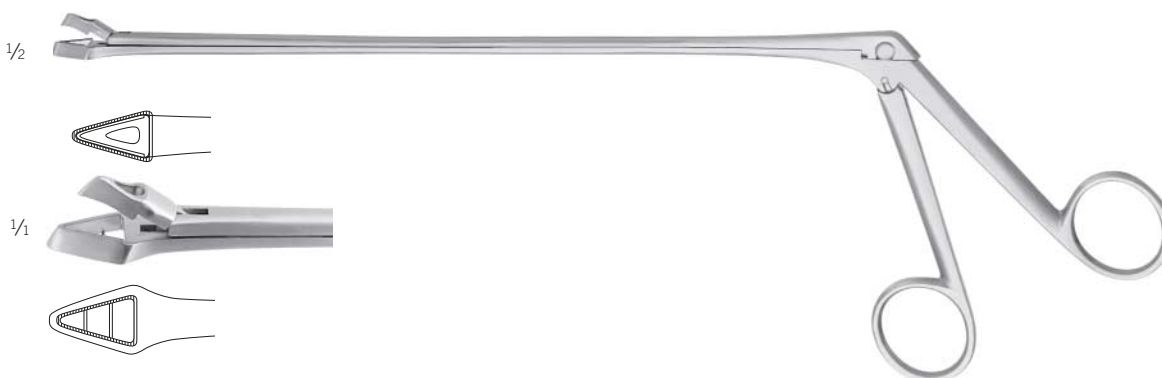
Maul 5,1 mm breit  
jaw 5,1 mm wide  
boca 5,1 mm de ancho  
mors largeur 5,1 mm  
morso larghezza 5,1 mm



Kevorkian  
32-859-32-07

Schaftlänge  
shaft length  
longitud del vástago  
longueur de la tige  
lunghezza dell'asta  
**250 mm**

Maul 3 mm breit  
jaw 3 mm wide  
boca 3 mm de ancho  
mors largeur 3 mm  
morso larghezza 3 mm



Schumacher  
32-861-02-07

Schaftlänge  
shaft length  
longitud del vástago  
longueur de la tige  
lunghezza dell'asta  
**225 mm**

Maul 5,4 mm breit  
jaw 5,4 mm wide  
boca 5,4 mm de ancho  
mors largeur 5,4 mm  
morso larghezza 5,4 mm

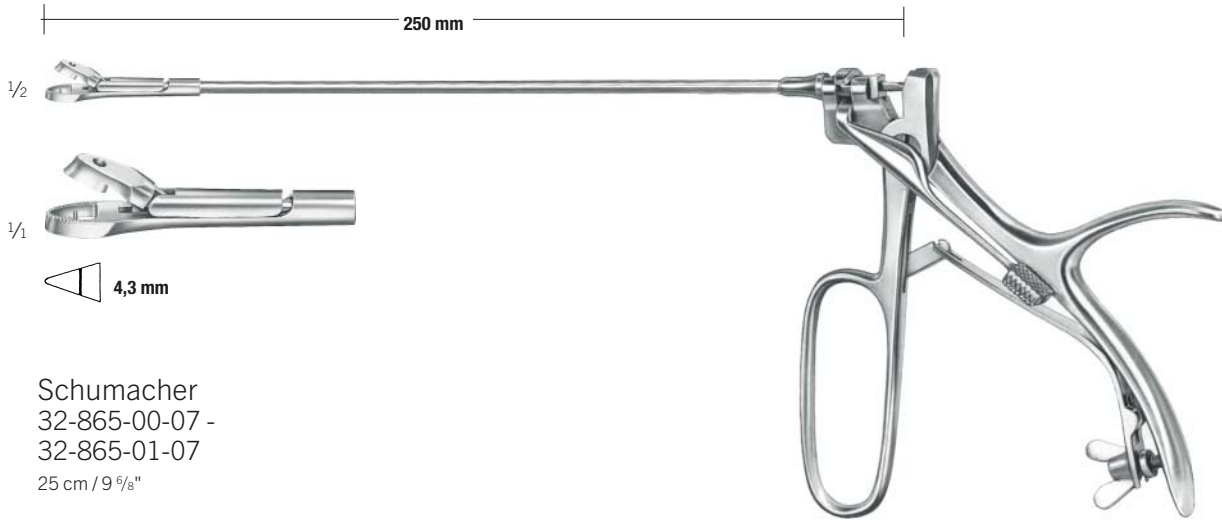
## Probeexzisionszangen, IUP-Fasszangen

Uterine Biopsy Forceps, IUP Grasping Forceps

Pinzas para biopsia, Pinzas para coger DIU

Pinces pour biopsie, Pinces pour DIU

Pinze per biopsia, Pinze per DIU



Schumacher

32-865-00-07 -

32-865-01-07

25 cm / 9 7/8"

32-865-00-07

Set, komplett, bestehend aus:  
Set, complete, consisting of:  
Juego, completo, formado por:  
Jeu, complet, composé de:  
Serie completa, consistente in:

39-581-01-07

39-584-20-07

32-865-01-07

Verlängerungsrohr  
Interchangeable tube  
Tubo de extension  
Tube rallonge  
Tubo allunghi

39-584-20-07 **22 cm**

39-584-30-07 **32 cm**

39-584-40-07 **41 cm**

Handgriff  
Handle  
Mango  
Manche  
Manico

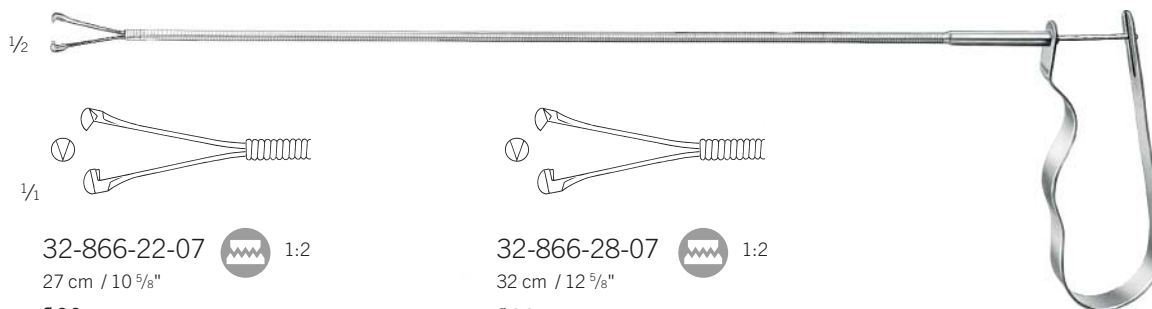
39-581-01-07


Aufsatz  
Tip  
Punta  
Embout  
Punta

32-865-01-07

Weitere Aufsätze siehe Seite 732 ff  
Further tips see page 732 ff  
Más pinzas miren página 732 ff  
Autres embouts voir page 732 ff  
Altri pinzi vedi pagina 732 ff

➔ 39-600-01-07 -  
39-647-01-07




32-866-22-07  1:2  
27 cm / 10 5/8"

**Ø 3,0 mm**  
Schaftlänge  
shaft length  
longitud del vástago  
longueur de la tige  
lunghezza dell'asta

**225 mm**

flexibler Schaft  
flexible shaft  
vástago flexible  
tige flexible  
asta flessibile

32-866-28-07  1:2  
32 cm / 12 5/8"

**Ø 3,0 mm**  
Schaftlänge  
shaft length  
longitud del vástago  
longueur de la tige  
lunghezza dell'asta

**270 mm**

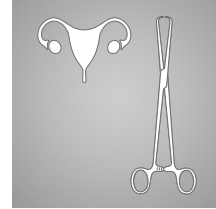
flexibler Schaft  
flexible shaft  
vástago flexible  
tige flexible  
asta flessibile

# Uteruslöffel, Uterusküretten

Uterine Scoops, Uterine Curettes  
 Cucharillas uterinas, Curetas uterinas  
 Curettes utérines, Curettes utérines  
 Curette uterine, Curette uterine

# Gynäkologie

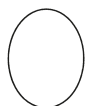
Gynecology  
 Ginecología  
 Gynécologie  
 Ginecologia



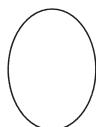
**Fig. 1**  
 32-900-01-07  
 23 cm / 9"  
 10 x 7 mm



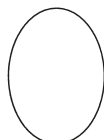
**Fig. 2**  
 32-900-02-07  
 23,5 cm / 9 3/8"  
 12 x 8 mm



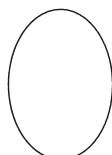
**Fig. 3**  
 32-900-03-07  
 24 cm / 9 1/8"  
 13 x 10 mm



**Fig. 4**  
 32-900-04-07  
 24 cm / 9 1/8"  
 16 x 12 mm



**Fig. 5**  
 32-900-05-07  
 24 cm / 9 1/8"  
 18 x 13 mm



**Fig. 6**  
 32-900-06-07  
 24 cm / 9 1/8"  
 20 x 15 mm



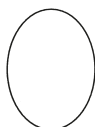
**Fig. 1**  
 32-906-01-07  
 10 x 7 mm



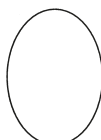
**Fig. 2**  
 32-906-02-07  
 12 x 8 mm



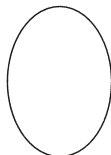
**Fig. 3**  
 32-906-03-07  
 13 x 10 mm



**Fig. 4**  
 32-906-04-07  
 16 x 12 mm



**Fig. 5**  
 32-906-05-07  
 18 x 13 mm



**Fig. 6**  
 32-906-06-07  
 20 x 15 mm



**13 mm**  
 stumpf  
 blunt  
 romo  
 mousse  
 smusso



**8 mm**  
 scharf  
 sharp  
 cortante  
 tranchante  
 taglient



Simon  
 32-900-01-07 -  
 32-900-06-07  
 scharf, fest  
 sharp, rigid  
 cortante, rígido  
 tranchante, rigide  
 tagliente, rigido



Schröder  
 32-906-01-07 -  
 32-906-06-07  
 30 cm / 11 5/8"  
 scharf, fest  
 sharp, rigid  
 cortante, rígido  
 tranchante, rigide  
 tagliente, rigido



Blake  
 32-919-00-07  
 27,5 cm / 10 7/8"

# Uterusküretten

Uterine Curettes  
Curetas uterinas  
Curettes utérines  
Curette uterine



| Fig. | Breite<br>width<br>anchura<br>largeur<br>larghezza | scharf, fest<br>sharp, rigid<br>cortante, rígido<br>tranchante, rigide<br>tagliente, rigido | scharf, biegsam<br>sharp, malleable<br>cortante, maleable<br>tranchante, malléable<br>tagliente, malleabile |
|------|--|---|---|
| 00   | 5 mm   | 32-920-05-07  | 32-921-05-07  |
| 0    | 6 mm   | 32-920-06-07  | 32-921-06-07  |
| 1    | 7 mm   | 32-920-07-07  | 32-921-07-07  |
| 2    | 8 mm   | 32-920-08-07  | 32-921-08-07  |
| 3    | 9 mm   | 32-920-09-07  | 32-921-09-07  |
| 4    | 11 mm  | 32-920-11-07  | 32-921-11-07  |
| 5    | 12 mm  | 32-920-12-07  | 32-921-12-07  |
| 6    | 14 mm  | 32-920-14-07  | 32-921-14-07  |
| 7    | 15 mm  | 32-920-15-07  | 32-921-15-07  |
| 8    | 16 mm  | 32-920-16-07  | 32-921-16-07  |
| 9    | 19 mm  | 32-920-19-07  | 32-921-19-07  |
| 10   | 20 mm  | 32-920-20-07  | 32-921-20-07  |
| 11   | 21 mm  | 32-920-21-07  | 32-921-21-07  |
| 12   | 23 mm  | 32-920-23-07  | 32-921-23-07  |
| 13   | 25 mm  | 32-920-25-07  | 32-921-25-07  |
| 14   | 30 mm  | 32-920-30-07  | 32-921-30-07  |
| 15   | 35 mm  | 32-920-35-07  | 32-921-35-07  |
| 16   | 40 mm  | 32-920-40-07  | 32-921-40-07  |

| Fig. | Breite<br>width<br>anchura<br>largeur<br>larghezza | stumpf, fest<br>blunt, rigid<br>romo, rígido<br>mousse, rigide<br>smusso, rigido | stumpf, biegsam<br>blunt, malleable<br>romo, maleable<br>mousse, malléable<br>smusso, malleabile |
|------|--|--|--|
| 00   | 5 mm   | 32-926-05-07   | 32-927-05-07   |
| 0    | 6 mm   | 32-926-06-07   | 32-927-06-07   |
| 1    | 7 mm   | 32-926-07-07   | 32-927-07-07   |
| 2    | 8 mm   | 32-926-08-07   | 32-927-08-07   |
| 3    | 9 mm   | 32-926-09-07   | 32-927-09-07   |
| 4    | 11 mm  | 32-926-11-07   | 32-927-11-07   |
| 5    | 12 mm  | 32-926-12-07   | 32-927-12-07   |
| 6    | 14 mm  | 32-926-14-07   | 32-927-14-07   |
| 7    | 15 mm  | 32-926-15-07   | 32-927-15-07   |
| 8    | 16 mm  | 32-926-16-07   | 32-927-16-07   |
| 9    | 19 mm  | 32-926-19-07   | 32-927-19-07   |
| 10   | 20 mm  | 32-926-20-07   | 32-927-20-07   |
| 11   | 21 mm  | 32-926-21-07   | 32-927-21-07   |
| 12   | 23 mm  | 32-926-23-07   | 32-927-23-07   |
| 13   | 25 mm  | 32-926-25-07   | 32-927-25-07   |
| 14   | 30 mm  | 32-926-30-07   | 32-927-30-07   |
| 15   | 35 mm  | 32-926-35-07   | 32-927-35-07   |
| 16   | 40 mm  | 32-926-40-07   | 32-927-40-07   |

Recamier                      Recamier                      Sims                      Sims  
 32-920-05-07 -      32-921-05-07 -      32-926-05-07 -      32-927-05-07 -  
 32-920-40-07      32-921-40-07      32-926-40-07      32-927-40-07

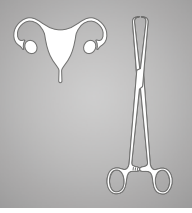


# Uterusküretten

Uterine Curettes  
Curetas uterinas  
Curettes utérines  
Curette uterine

# Gynäkologie

Gynecology  
Ginecología  
Gynécologie  
Ginecologia



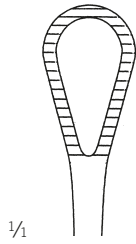
## Uterusküretten, Absaugküretten

Uterine Curettes, Suction Curettes

Curetas uterinas, Curetas aspiradoras

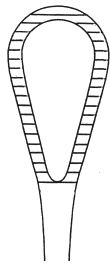
Curettes utérines, Curettes d'aspiration

Curette uterine, Curette per aspirazione

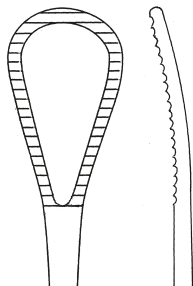


1/1

10 mm  
32-924-10-07



12 mm  
32-924-12-07



14 mm  
32-924-14-07



1/2

Greene  
32-924-10-07 -  
32-924-14-07  
28 cm / 11 "



1/1

Ø 3,0 mm  
32-989-03-01



Ø 4,5 mm  
32-989-04-01



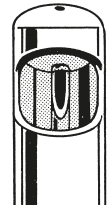
Ø 6,0 mm  
32-989-06-01



Ø 8,0 mm  
32-989-08-01



Ø 10 mm  
32-989-10-01

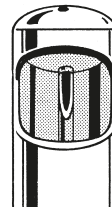


Ø 12 mm  
32-989-12-01



1/2

32-989-03-01 -  
32-989-14-01  
29 cm / 11 3/8"



Ø 14 mm  
32-989-14-01

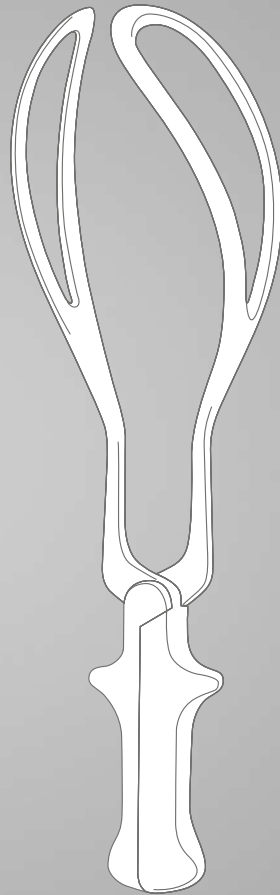


1/2

32-989-50-01  
11 cm / 4 3/8"  
Kupplungsstück  
Coupling Piece  
Pieza de acoplamiento  
Pièce de raccordement  
Pezzo di collegamento

Geburtshilfe  
Obstetrics  
Obstetricia  
Obstétrique  
Ostetricia

# 33



## Beckenzirkel, Geburtszangen

Pelvimeter

Pelvímetro

Pelvimètre

Pelvimetri



Skala in cm und Inch  
cm / inch scale  
escala en cm / pulgadas  
échelle en cm / pouces  
scal in cm / pollici

1/4

Martin  
33-103-34-07  
35 cm / 13 5/8"



1/4

Nägele  
33-141-36-07 = 36,5 cm / 14 3/8"  
33-141-40-07 = 40,5 cm / 16"



1/4

Simpson  
33-145-30-07  
30,5 cm / 12"



1/4

Wrigley  
33-146-28-07  
28 cm / 11"



1/4

Simpson  
33-149-36-07  
36,5 cm / 14 3/8"

## Geburtszangen

Obstetrical Forceps  
Forceps obstétricos  
Forceps obstétriques  
Forcipi obstetrici

## Geburtshilfe

Obstetrics  
Obstetricia  
Obstétrique  
Ostetricia



1/4

Kielland  
33-195-41-07  
41 cm / 16 1/8"



1/4

Piper  
33-198-44-07  
44,5 cm / 17 1/8"

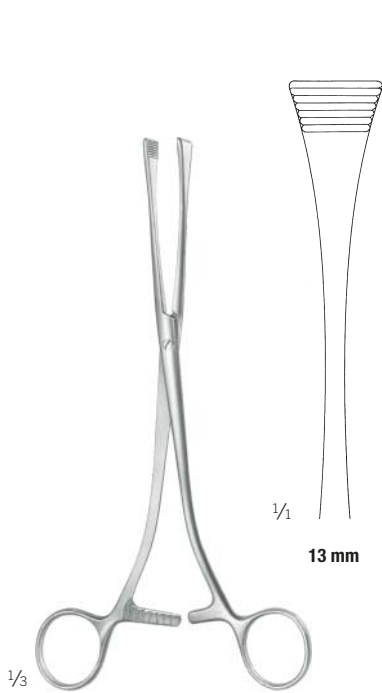
## Abortuszangen

Placenta and Ovum Forceps

Pinzas para aborto

Pinces placentaires et pour poste-abortum

Pinze per placenta e per ovaie



13 mm

**Green-Armytage**  
33-300-21-07

21 cm / 8 2/8"

Klemmzange

Uterine Clamp

Pinza uterina para hemostasis

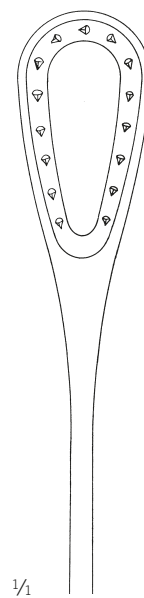
Pince utérine pour hémostase

Pinza emostatiche per tagli cesarei



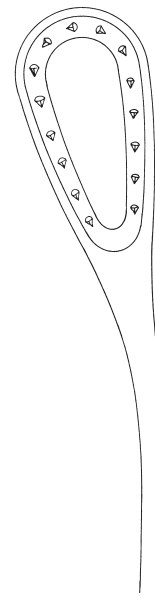
1/3

**Sänger**  
33-328-27-07 -  
33-329-27-07



1/1

**17,5 mm**  
33-328-27-07  
27,5 cm / 10 7/8"

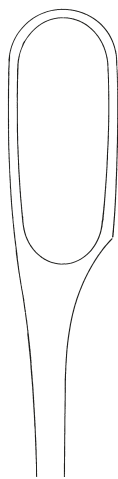


**17,5 mm**  
33-329-27-07  
27 cm / 10 5/8"

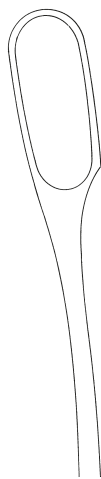


1/1

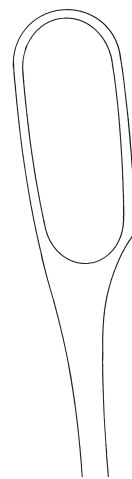
**9,5 mm**  
**Fig. 1**  
33-344-01-07



**13,5 mm**  
**Fig. 2**  
33-344-02-07



**9,5 mm**  
**Fig. 1**  
33-345-01-07



**13,5 mm**  
**Fig. 2**  
33-345-02-07



1/3

**Sellheim**  
33-309-28-07  
32 cm / 12 5/8"  
Geburtslöffel  
Obstetrical Lever  
Elevador obstétrico  
Levier obstétrique  
Leva ostetrica

**Winter**  
33-344-01-07 -  
33-345-02-07  
28 cm / 11"

## Abortuslöffel

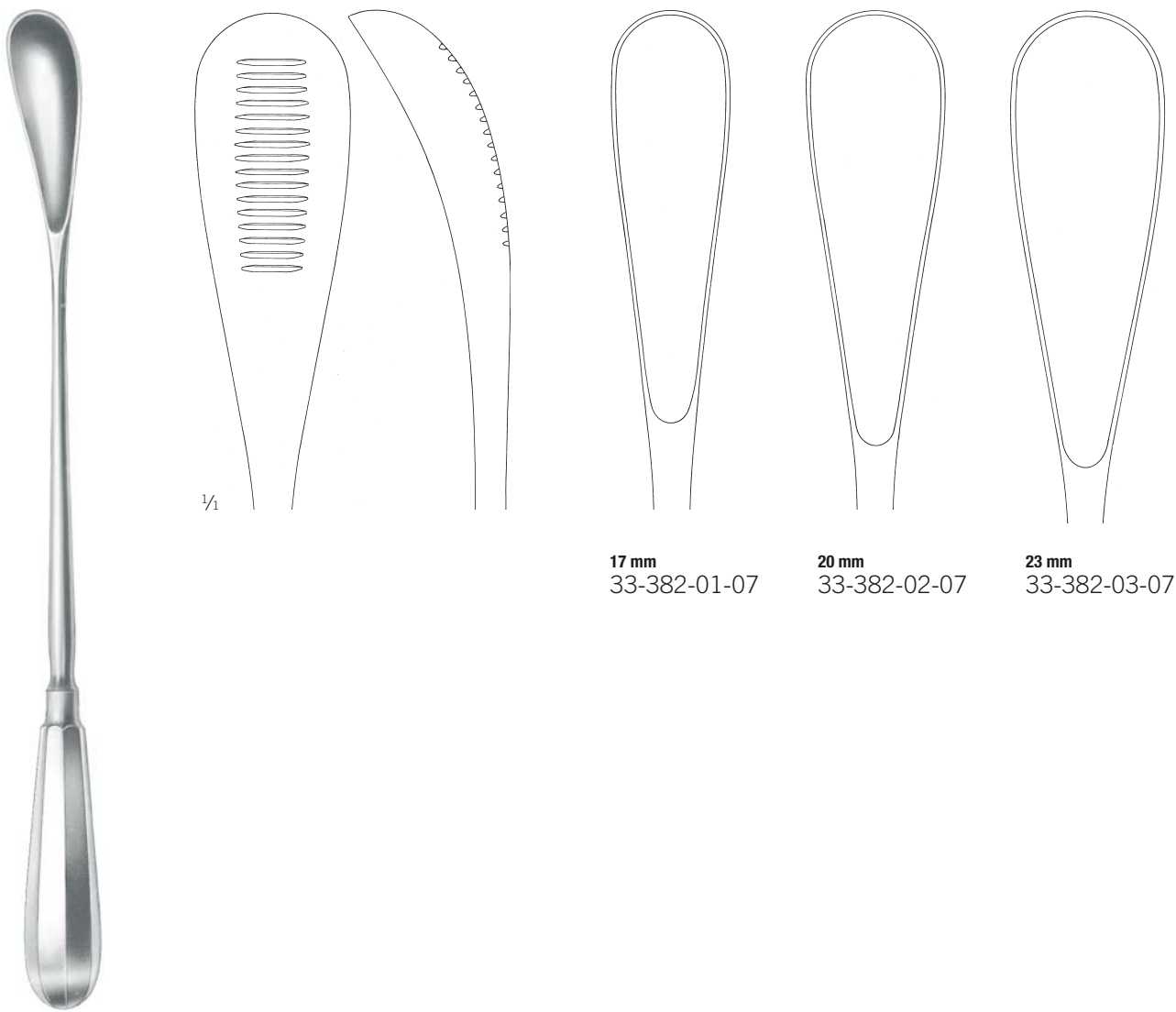
Placenta Scoops  
Cucharillas para aborto  
Curettes a avortement et placenta  
Cucchiai per placenta e ovaie

## Geburtshilfe

Obstetrics  
Obstetricia  
Obstétrique  
Ostetricia



33



Cuzzi  
33-382-01-07 -  
33-382-03-07

30 cm / 11 5/8"

stumpf, Rückseite gerieft  
blunt, backside serrated  
romo, dorso estriado  
mousse, verso estrie  
smusso, dorso scanallato

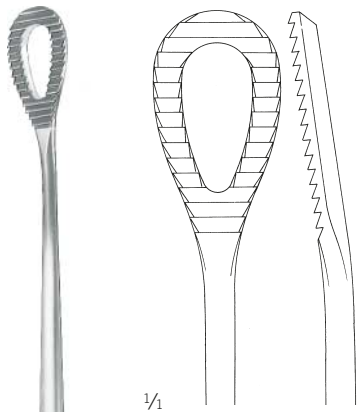
## Abortuslöffel, Nabelschnurklemme

Placenta Scoops, Umbilical Cord Clamp

Cucharillas para aborto, Clamp umbilical

Curettes a avortement et placenta, Clamp pour le cordon ombilical

Cucchiai per placenta e ovaie, Clamp ombelicale



1/1



1/1

Pestalozza  
33-386-30-07  
30,5 cm / 12 "



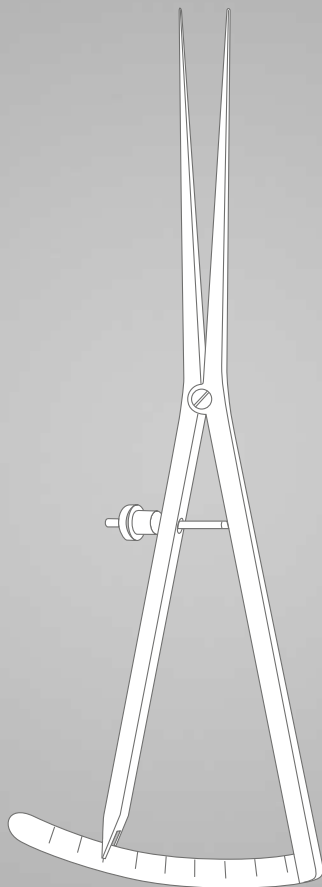
1/2

Collin  
33-465-09-07  
8,5 cm / 3 3/8"



Zirkel  
Calipers  
Compasses  
Compas  
Compassi

# 35



**Zirkel**  
Calipers  
Compasses  
Compas  
Compassi



Castroviejo  
35-133-06-07  
8 cm / 3 1/8"  
Bereich  
range  
alcance  
série  
rango  
**0-15 mm**



Castroviejo  
35-133-07-07  
8 cm / 3 1/8"  
Bereich  
range  
alcance  
série  
rango  
**0-20 mm**



Castroviejo  
35-133-09-07  
8 cm / 3 1/8"  
Bereich  
range  
alcance  
série  
rango  
**0-20 mm**



Castroviejo-Epker  
35-134-09-07  
9 cm / 3 1/8"  
Bereich  
range  
alcance  
série  
rango  
**0-40 mm**



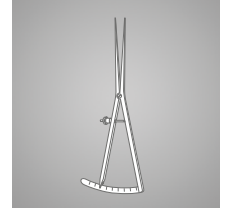
Castroviejo-Epker  
35-134-18-07  
18 cm / 7 1/8"  
Bereich  
range  
alcance  
série  
rango  
**0-40 mm**

## Sonden

Probes  
Sondas  
Sondes  
Sonde

## Messzirkel

Calipers  
Compasses  
Compas  
Compassi



Ag



1/1

Bowman  
35-224-00-18 -  
35-224-78-18  
13 cm / 5 1/8"

|              | Fig.       |
|--------------|------------|
| 35-224-99-18 | 0000 / 000 |
| 35-224-00-18 | 00 / 0     |
| 35-224-01-18 | 0 / 1      |
| 35-224-12-18 | 1 / 2      |
| 35-224-23-18 | 2 / 3      |
| 35-224-34-18 | 3 / 4      |
| 35-224-45-18 | 4 / 5      |
| 35-224-56-18 | 5 / 6      |
| 35-224-67-18 | 6 / 7      |
| 35-224-78-18 | 7 / 8      |



1/1

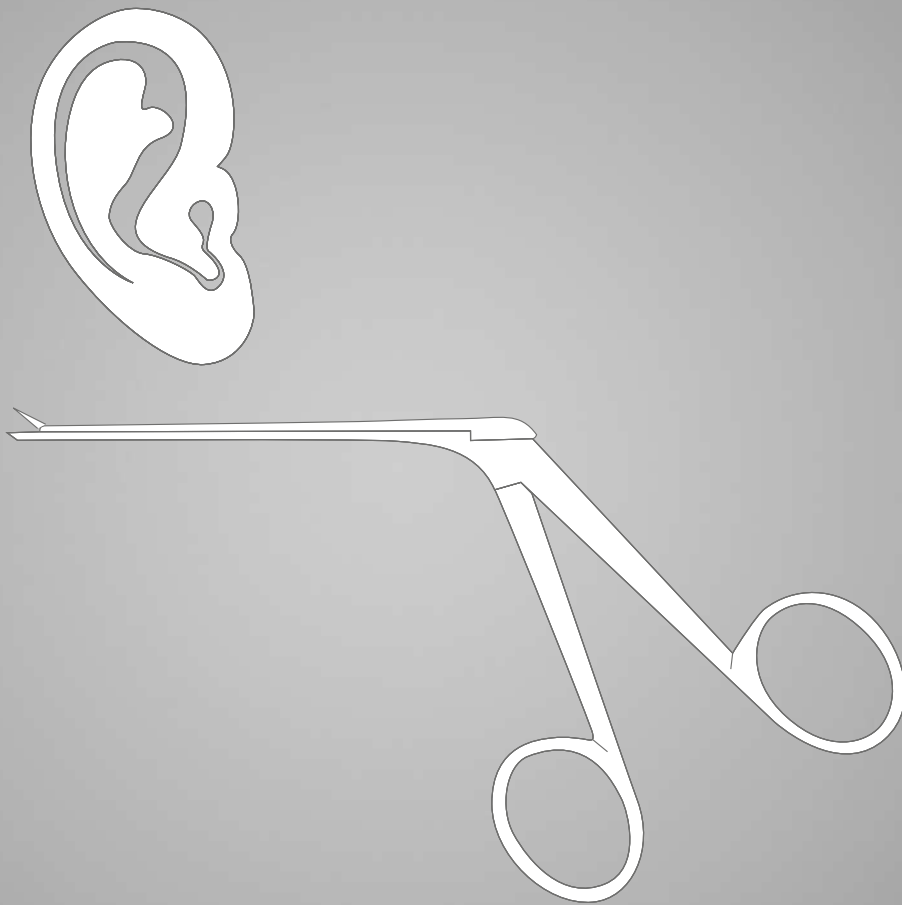
Bowman  
35-226-00-18 -  
35-226-78-18  
13 cm / 5 1/8"

|              | Fig.   |
|--------------|--------|
| 35-226-00-18 | 00 / 0 |
| 35-226-01-18 | 0 / 1  |
| 35-226-12-18 | 1 / 2  |
| 35-226-23-18 | 2 / 3  |
| 35-226-34-18 | 3 / 4  |
| 35-226-45-18 | 4 / 5  |
| 35-226-56-18 | 5 / 6  |
| 35-226-67-18 | 6 / 7  |
| 35-226-78-18 | 7 / 8  |



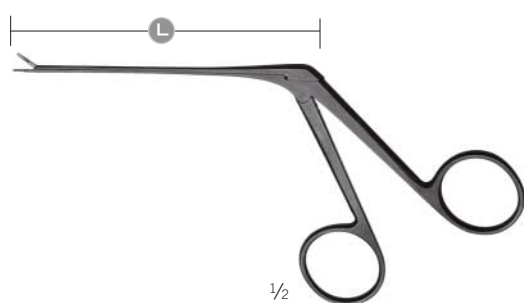
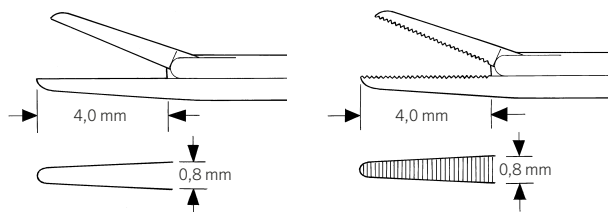
Otologie  
Otology  
Otología  
Otologie  
Otología

# 36

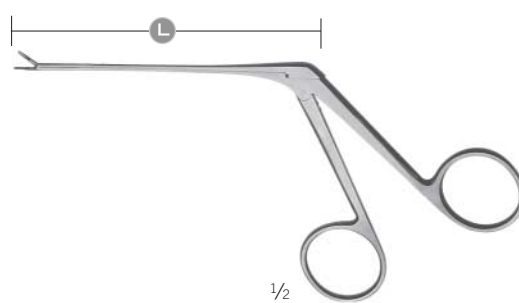


# Mikro-Ohrzängchen

Micro Ear Forceps  
 Micro pinzas auriculares  
 Micro Pince auriculaires  
 Micro Pinze auricolari



36-001-01-14 -  
 36-001-09-14



36-001-01-07 -  
 36-001-09-07

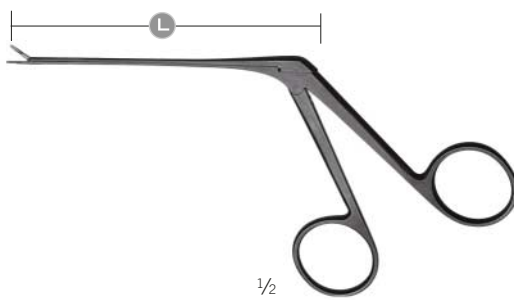
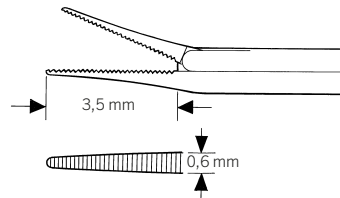
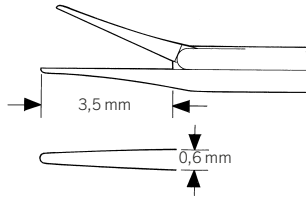
|     | gerade, glatt<br>straight, smooth<br>recta, lisa<br>droite, lisse<br>retta, liscia | gerade, gerieft<br>straight, serrated<br>recta, estriada<br>droite, striée<br>retta, con scanalatura | aufgebogen, gerieft<br>bent upwards, serrated<br>curva por arriba, estriada<br>courbée v. le haut, striée<br>curva in alto,<br>con scanalatura | rechts, gerieft<br>right, serrated<br>derecha, estriada<br>droite, striée<br>destra, con scanalatura | links, gerieft<br>left, serrated<br>izquierda, estriada<br>gauche, striée<br>sinistra, con scanalatura |
|-----|--|--|--|--|--|
| 1/1 |  |  |  |  |  |
| L   | <b>8 cm</b>  | <b>8 cm</b>  | <b>8 cm</b>  | <b>8 cm</b>  | <b>8 cm</b>  |
| SB  | 36-001-01-14   | 36-001-06-14   | 36-001-07-14   | 36-001-08-14   | 36-001-09-14   |
| St  | 36-001-01-07   | 36-001-06-07   | 36-001-07-07   | 36-001-08-07   | 36-001-09-07   |

# Mikro-Ohrzängchen

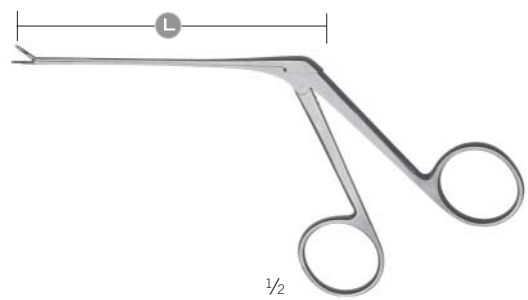
Micro Ear Forceps  
 Micro pinzas auriculares  
 Micro Pince auriculaires  
 Micro Pinze auricolari

# Otologie

Otology  
 Otología  
 Otologie  
 Otologia



Mini-McGee  
 36-001-11-14 -  
 36-001-16-14



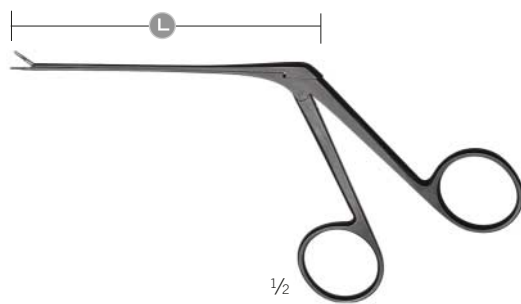
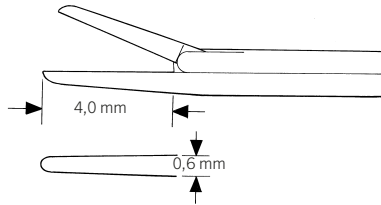
Mini-McGee  
 36-001-11-07 -  
 36-001-16-07

36

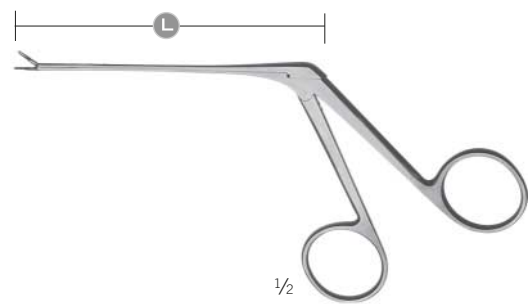
|     |  |  |
|-----|--|--|
|     | gerade, glatt<br>straight, smooth<br>recta, lisa<br>droite, lisse<br>retta, liscia | gerade, gerieft<br>straight, serrated<br>recta, estriada<br>droite, striée<br>retta, con scanalatura |
| 1/1 |  |  |
| L   | <b>8 cm</b>  | <b>8 cm</b>  |
| SB  | 36-001-11-14   | 36-001-16-14   |
| St  | 36-001-11-07   | 36-001-16-07   |

# Mikro-Ohrzängchen

Micro Ear Forceps  
 Micro pinzas auriculares  
 Micro Pince auriculaires  
 Micro Pinze auricolari



36-001-21-14



36-001-21-07

|     |  |
|-----|--|
|     | <p><b>gerade, glatt</b><br/> <b>straight, smooth</b><br/> <b>recta, lisa</b><br/> <b>droite, lisse</b><br/> <b>retta, liscia</b></p> |
| 1/1 |  |
| L   | <b>8 cm</b>  |
| SB  | 36-001-21-14   |
| St  | 36-001-21-07   |

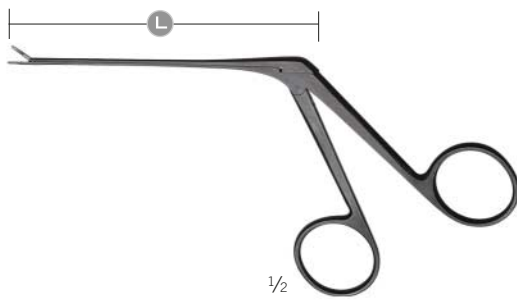
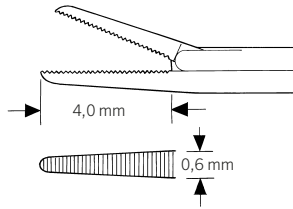
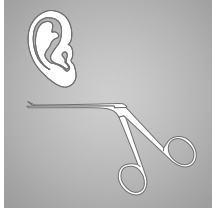


# Mikro-Ohrzängchen

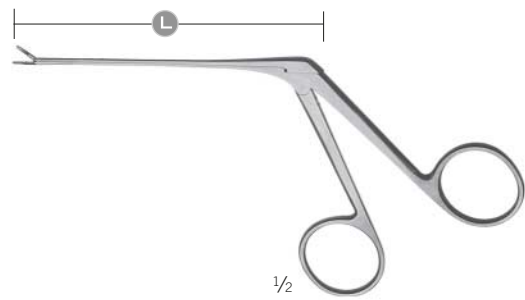
Micro Ear Forceps  
 Micro pinzas auriculares  
 Micro Pince auriculaires  
 Micro Pinze auricolari

# Otologie

Otology  
 Otología  
 Otologie  
 Otologia



36-001-26-14



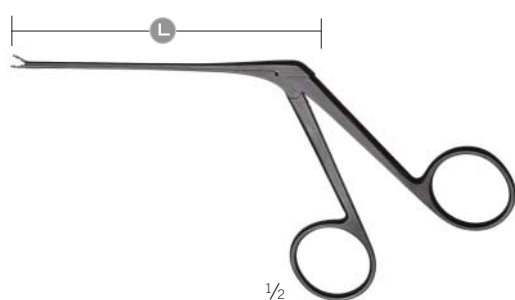
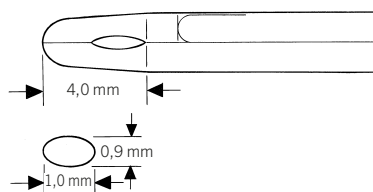
36-001-26-07

36

|     |  |
|-----|--|
|     | gerade, gerieft<br>straight, serrated<br>recta, estriada<br>droite, striée<br>retta, con scanalatura |
| 1/1 |  |
| L   | 8 cm   |
| SB  | 36-001-26-14   |
| St  | 36-001-26-07   |

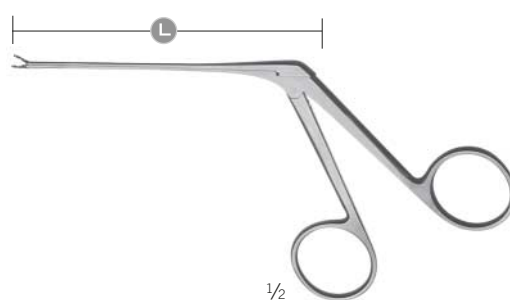
# Mikro-Ohrzängchen

Micro Ear Forceps  
 Micro pinzas auriculares  
 Micro Pince auriculaires  
 Micro Pinze auricolari



36-003-01-14 -  
 36-003-04-14

Löffel  
 cup  
 cucharilla  
 curette  
 cucchiaio



36-003-01-07 -  
 36-003-04-07

Löffel  
 cup  
 cucharilla  
 curette  
 cucchiaio

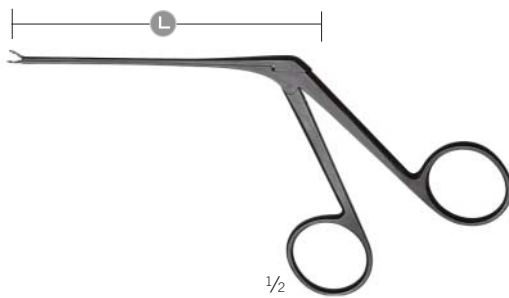
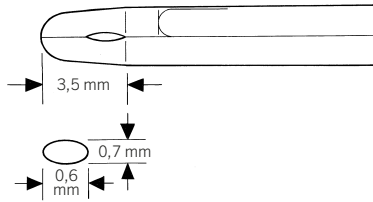
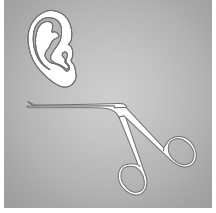
|     | gerade<br>straight<br>recta<br>droite<br>retta | aufgebogen<br>bent upwards<br>curva por arriba<br>courbée en haut<br>curva in alto | rechts<br>right<br>derecha<br>droite<br>destra | links<br>left<br>izquierda<br>gauche<br>sinistra |
|-----|--|--|--|--|
| 1/1 |  |  |  |  |
| L   | 8 cm   | 8 cm   | 8 cm   | 8 cm   |
| SB  | 36-003-01-14                                   | 36-003-02-14   | 36-003-03-14                                   | 36-003-04-14                                     |
| St  | 36-003-01-07                                   | 36-003-02-07   | 36-003-03-07                                   | 36-003-04-07                                     |

# Mikro-Ohrzängchen

Micro Ear Forceps  
 Micro pinzas auriculares  
 Micro Pince auriculaires  
 Micro Pinze auricolari

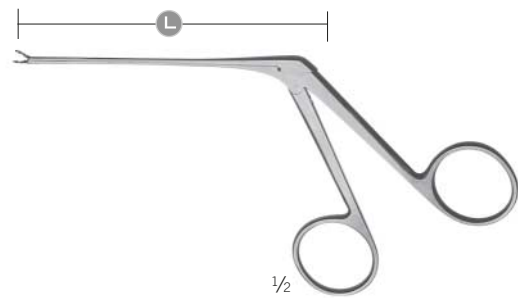
# Otologie

Otology  
 Otología  
 Otologie  
 Otologia



Mini-McGee  
 36-003-11-14 -  
 36-003-14-14

Löffel  
 cup  
 cucharilla  
 curette  
 cucchiaino



Mini-McGee  
 36-003-11-07 -  
 36-003-14-07

Löffel  
 cup  
 cucharilla  
 curette  
 cucchiaino

|     | gerade<br>straight<br>recta<br>droite<br>retta | aufgebogen<br>bent upwards<br>curva por arriba<br>courbée en haut<br>curva in alto | rechts<br>right<br>derecha<br>droite<br>destra | links<br>left<br>izquierda<br>gauche<br>sinistra |
|-----|--|--|--|--|
| 1/1 |  |  |  |  |
| L   | <b>8 cm</b>                                    | <b>8 cm</b>  | <b>8 cm</b>                                    | <b>8 cm</b>                                      |
| SB  | 36-003-11-14                                   | 36-003-12-14   | 36-003-13-14                                   | 36-003-14-14                                     |
| St  | 36-003-11-07                                   | 36-003-12-07   | 36-003-13-07                                   | 36-003-14-07                                     |

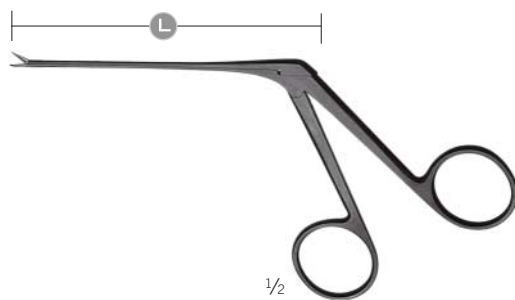
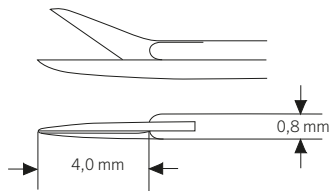
# Mikro-Ohrscherchen

Micro Ear Scissors

Micro tijeras auriculares

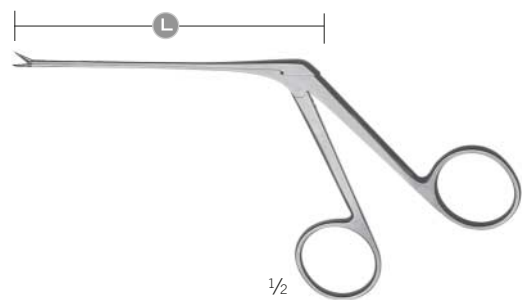
Micro Ciseaux auriculaires

Micro Forbici auricolari



Bellucci  
36-005-01-14 -  
36-005-04-14

sehr fein  
very delicate  
muy fino  
très fin  
strafino



Bellucci  
36-005-01-07 -  
36-005-04-07

sehr fein  
very delicate  
muy fino  
très fin  
strafino

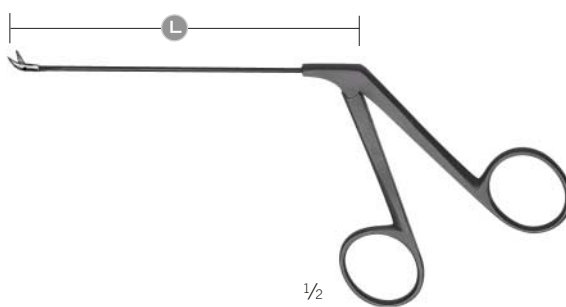
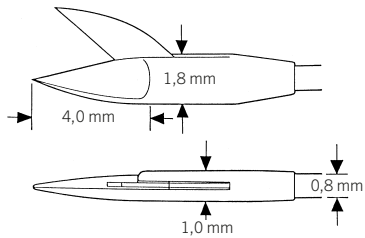
|     | gerade<br>straight<br>recta<br>droite<br>retta | aufgebogen<br>bent upwards<br>curva por arriba<br>courbée en haut<br>curva in alto | rechts<br>right<br>derecha<br>droite<br>destra | links<br>left<br>izquierda<br>gauche<br>sinistra |
|-----|--|--|--|--|
| 1/1 |  |  |  |  |
| L   | <b>8 cm</b>                                    | <b>8 cm</b>  | <b>8 cm</b>                                    | <b>8 cm</b>                                      |
| SB  | 36-005-01-14                                   | 36-005-02-14   | 36-005-03-14                                   | 36-005-04-14                                     |
| St  | 36-005-01-07                                   | 36-005-02-07   | 36-005-03-07                                   | 36-005-04-07                                     |

## Mikro-Ohrscherchen

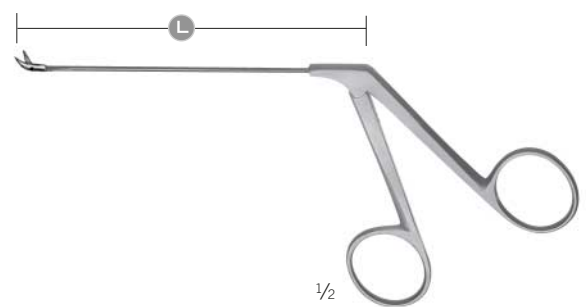
Micro Ear Scissors  
 Micro tijeras auriculares  
 Micro Ciseaux auriculaires  
 Micro Forbici auricolari

## Otologie

Otology  
 Otología  
 Otologie  
 Otologia



Wullstein  
 36-005-51-14 -  
 36-005-54-14



Wullstein  
 36-005-51-07 -  
 36-005-54-07

36

|     | gerade<br>straight<br>recta<br>droite<br>retta | aufgebogen<br>bent upwards<br>curva por arriba<br>courbée en haut<br>curva in alto | rechts<br>right<br>derecha<br>droite<br>destra | links<br>left<br>izquierda<br>gauche<br>sinistra |
|-----|--|--|--|--|
| 1/1 |  |  |  |  |
| L   | 9 cm   | 9 cm   | 9 cm   | 9 cm   |
| SB  | 36-005-51-14                                   | 36-005-52-14   | 36-005-53-14                                   | 36-005-54-14                                     |
| St  | 36-005-51-07                                   | 36-005-52-07   | 36-005-53-07                                   | 36-005-54-07                                     |

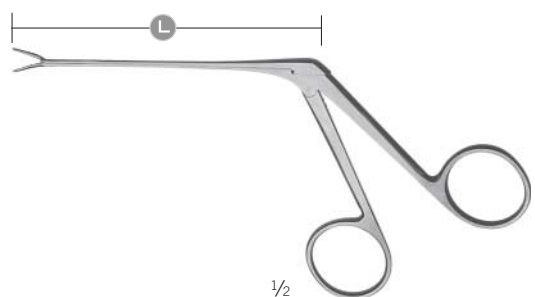
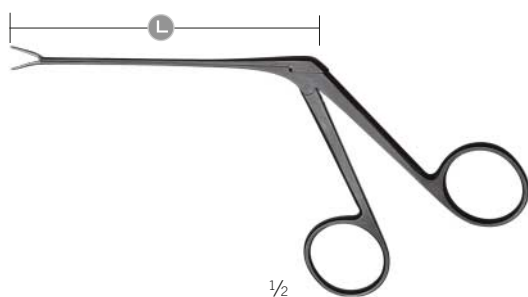
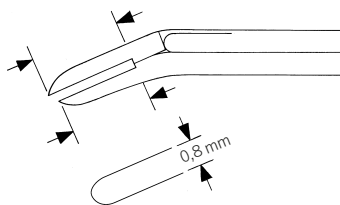
## Mikro-Ohrzängchen

Micro Ear Forceps

Micro pinzas auriculares

Micro Pince auriculaires

Micro Pinze auricolari



McGee

36-010-11-14 -

36-010-12-14

Drahtbiegezängchen

Wire Bending Forceps

Pinza para plegar alambre

Pince à plier les fils d'acier

Pinza per piegare fili metallici

McGee

36-010-11-07 -

36-010-12-07



Drahtbiegezängchen

Wire Bending Forceps

Pinza para plegar alambre

Pince à plier les fils d'acier

Pinza per piegare fili metallici

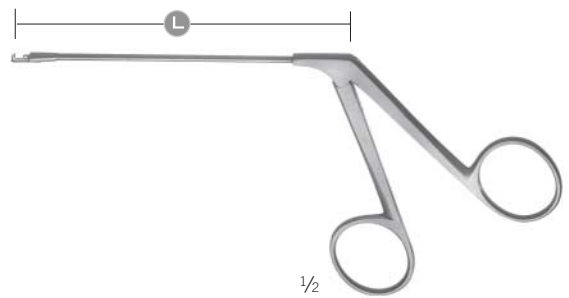
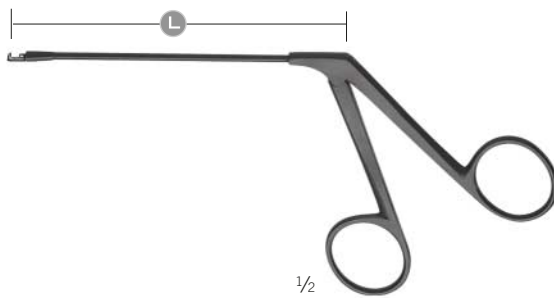
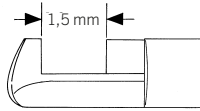
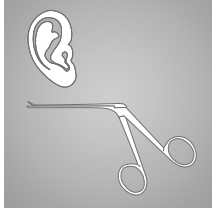
|     | abgewinkelt<br>angled downward<br>acodado abajo<br>angulé vers le bas<br>angolato verso il basso    | abgewinkelt<br>angled downward<br>acodado abajo<br>angulé vers le bas<br>angolato verso il basso  |
|-----|---|---|
| 1/1 | <br>0,8 x 3,5 mm | <br>0,8 x 6 mm |
| L   | 8 cm  | 8 cm  |
| SB  | 36-010-11-14  | 36-010-12-14  |
| St  | 36-010-11-07  | 36-010-12-07  |

# Mikro-Ohrzängchen

Micro Ear Forceps  
 Micro pinzas auriculares  
 Micro Pince auriculaires  
 Micro Pinze auricolari

# Otologie

Otology  
 Otolología  
 Otologie  
 Otologia



House-Dieter  
 36-011-01-14 -  
 36-011-07-14  
 Hammerkopfzängchen  
 Malleus Nipper  
 Pinza para cabezal del maléolo  
 Pince pour l'os marteau  
 Pinza per testa del martelletto

House-Dieter  
 36-011-01-07 -  
 36-011-07-07  
 Hammerkopfzängchen  
 Malleus Nipper  
 Pinza para cabezal del maléolo  
 Pince pour l'os marteau  
 Pinza per testa del martelletto

|     | oben schneidend<br>up-cutting<br>corte arriba<br>tranchante en haut<br>tagliente in alto | unten schneidend<br>down-cutting<br>corte abajo<br>tranchante en bas<br>tagliente in basso | rechts schneidend<br>right-cutting<br>corte derecho<br>tranchant à droite<br>tagliente a destra | links schneidend<br>left-cutting<br>corte izquierdo<br>tranchant à gauche<br>tagliente a sinistra |
|-----|--|--|---|---|
| 1/1 |  |  |   |   |
| L   | <b>9 cm</b>  | <b>9 cm</b>  | <b>9 cm</b>   | <b>9 cm</b>   |
| SB  | 36-011-01-14   | 36-011-02-14   | 36-011-06-14  | 36-011-07-14  |
| St  | 36-011-01-07   | 36-011-02-07   | 36-011-06-07  | 36-011-07-07  |

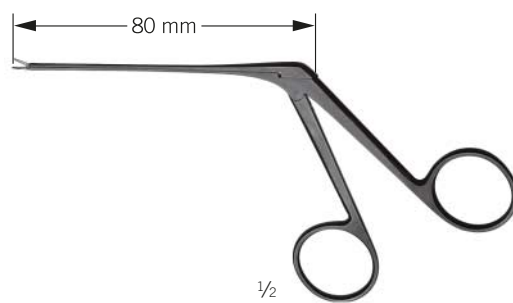
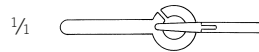
## Mikro-Ohrzängchen

Micro Ear Forceps


Micro pinzas auriculares

Micro Pince auriculaires

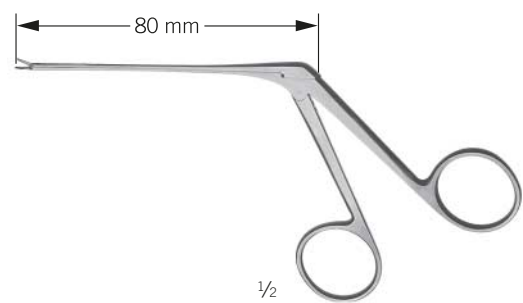
Micro Pinze auricolari



Fuller

36-013-01-14 

Einführungszängchen, für Teflonprothesen  
Introducing Forceps, for teflon prosthesis  
Pinza para introducir, para prótesis de teflon  
Pince pour introduction, pour prothèse en téflon  
Pinza per introduzione, per protesi in teflon



Fuller

36-013-01-07 

Einführungszängchen, für Teflonprothesen  
Introducing Forceps, for teflon prosthesis  
Pinza para introducir, para prótesis de teflon  
Pince pour introduction, pour prothèse en téflon  
Pinza per introduzione, per protesi in teflon

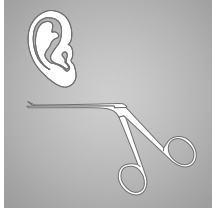


# Mikro-Ohrmesser

Micro Ear Knives  
 Micro cuchillos auriculares  
 Micro Couteaux auriculaires  
 Micro Coltelli

# Otologie

Otology  
 Otología  
 Otologie  
 Otologia



**Schuknecht**  
 36-020-06-07  
 14,5 cm / 5 9/16"  
 Sichelmesser  
 Sickle Knife  
 Cuchillo de hoz  
 Synéchiotome  
 Coltello falcato  
 come sinechia



**Wullstein**  
 36-020-11-07  
 15,5 cm / 6 1/8"  
 Sichelmesser  
 Sickle Knife  
 Cuchillo de hoz  
 Synéchiotome  
 Coltello falcato  
 come sinechia



**Tabb**  
 36-020-16-07  
 15,5 cm / 6 1/8"  
 Schleimhautmesser  
 Mucosa Knife  
 Cuchillo para mucosa  
 Couteau pour muqueuse  
 Bisturi per mucosa



**Plester**  
 36-020-21-07  
 15 cm / 5 7/8"  
 Lappenmesser  
 Flap Knife  
 Cuchillo para lóbulos  
 Couteau lobaire  
 Coltello per lobi



**Rosen**  
 36-022-01-07 -  
 36-022-07-07  
 15 cm / 5 7/8"

|              |        |          |  |
|--------------|--------|----------|--|
| 36-022-01-07 | Fig. 1 | Ø 3,0 mm |  |
| 36-022-02-07 | Fig. 2 | Ø 2,8 mm |  |
| 36-022-03-07 | Fig. 3 | Ø 2,6 mm |  |
| 36-022-04-07 | Fig. 4 | Ø 2,0 mm |  |
| 36-022-05-07 | Fig. 5 | Ø 1,6 mm |  |
| 36-022-06-07 | Fig. 6 | Ø 1,4 mm |  |
| 36-022-07-07 | Fig. 7 | Ø 1,0 mm |  |

## Mikro-Ohrhäkchen, Mikro-Ohrnadeln

Micro Ear Hooks, Micro Ear Needles

Micro ganchitos auriculares, Micro agujas auriculares

Micro Crochets auriculaires, Micro Aiguilles auriculaires

Micro Uncini auricolari, Micro Aghi auricolari

1/4



Barbara  
36-024-01-07



Barbara  
36-024-02-07



Barbara  
36-024-03-07



Rosen  
36-024-04-07

1/4



**25°**  
Haken  
hook  
gancho  
crochet  
gancio

|              |        |
|--------------|--------|
| 36-024-06-07 | 0,3 mm |
| 36-024-07-07 | 0,6 mm |
| 36-024-08-07 | 1,0 mm |



**45°**  
Haken  
hook  
gancho  
crochet  
gancio

|              |        |
|--------------|--------|
| 36-024-11-07 | 0,3 mm |
| 36-024-12-07 | 0,6 mm |
| 36-024-13-07 | 1,0 mm |
| 36-024-14-07 | 1,2 mm |
| 36-024-15-07 | 1,5 mm |
| 36-024-16-07 | 2,0 mm |
| 36-024-17-07 | 2,5 mm |



**90°**  
Haken  
hook  
gancho  
crochet  
gancio

|              |        |
|--------------|--------|
| 36-024-21-07 | 0,3 mm |
| 36-024-22-07 | 0,6 mm |
| 36-024-23-07 | 1,0 mm |
| 36-024-24-07 | 1,2 mm |
| 36-024-25-07 | 1,5 mm |
| 36-024-26-07 | 2,0 mm |
| 36-024-27-07 | 2,5 mm |



|              |        |
|--------------|--------|
| 36-024-31-07 | 0,5 mm |
| 36-024-32-07 | 1,0 mm |



1/2

36-024-01-07 -  
36-024-32-07  
16 cm / 6 2/8"

## Mikro-Ohrhäkchen, Mikro-Ohrnadeln

Micro Ear Hooks, Micro Ear Needles

Micro ganchitos auriculares, Micro agujas auriculares

Micro Crochets auriculaires, Micro Aiguilles auriculaires

Micro Uncini auricolari, Micro Aghi auricolari

## Otologie

Otology

Otología

Otologie

Otologia



1/1



aufgewinkelt  
bent upwards  
angulado hacia arriba  
coudé en haut  
angolato in alto  
**90°**



abgewinkelt  
angled  
angulada  
coudée  
angolata  
**90°**



aufgebogen  
bent upwards  
angulado hacia arriba  
coudé en haut  
angolato in alto



abgewinkelt  
angled  
angulada  
coudée  
angolata

McGee

McGee

|              |        |
|--------------|--------|
| 36-025-01-07 | 0,3 mm |
| 36-025-02-07 | 0,6 mm |
| 36-025-03-07 | 1,0 mm |

|              |        |
|--------------|--------|
| 36-025-06-07 | 0,3 mm |
| 36-025-07-07 | 0,6 mm |
| 36-025-08-07 | 1,0 mm |

|              |        |
|--------------|--------|
| 36-027-01-07 | 0,5 mm |
| 36-027-02-07 | 1,0 mm |

|              |        |
|--------------|--------|
| 36-027-11-07 | 0,5 mm |
| 36-027-12-07 | 1,0 mm |

für Fußplatte  
for footplate  
para la platina estapediense  
pour la platine de l'étrier  
per la piedistallo

für Fußplatte  
for footplate  
para la platina estapediense  
pour la platine de l'étrier  
per la piedistallo

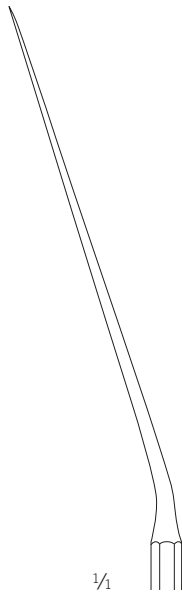
1/2

36-025-01-07 -  
36-027-12-07

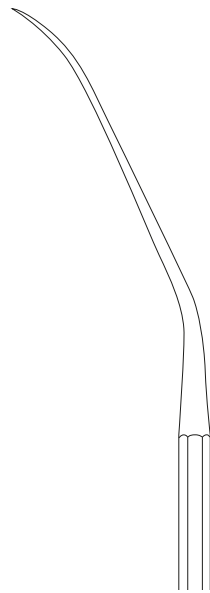
15,5 cm / 6 1/8"



1/2



1/1



Barbara  
36-029-01-07 -  
36-029-06-07

15,5 cm / 6 1/8"

36-029-01-07

36-029-06-07

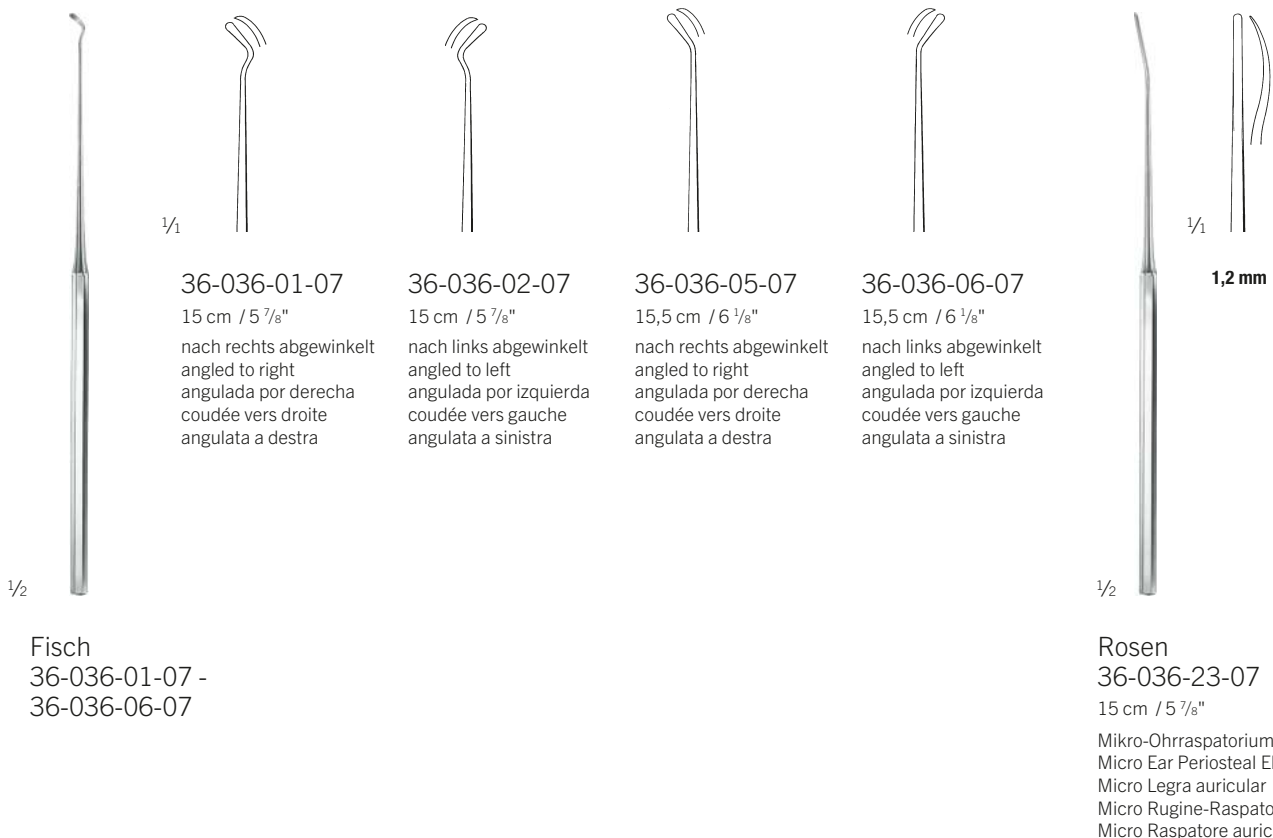
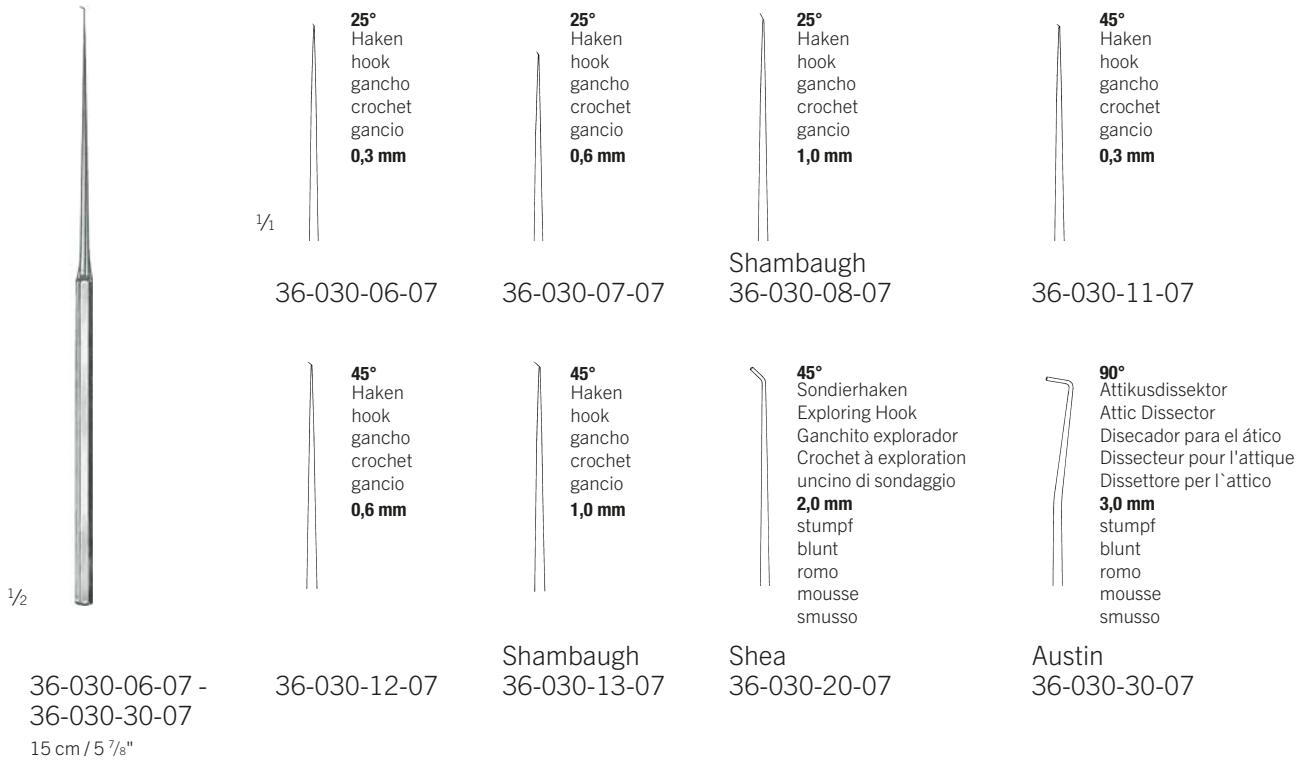
## Mikro-Ohrhäkchen, Mikro-Dissektoren

Micro Ear Hooks, Micro Dissectors

Micro ganchitos auriculares, Micro disecadores

Micro Crochets auriculaires, Micro Dissecteurs

Micro Uncini auricolari, Micro Dissettori



## Mikro-Küretten, Mikro-Messsonden

Micro Curettes, Micro Measuring Rods  
 Micro cucharillas, Micro Sondas para medir  
 Micro Curettes, Micro Sondes pour mesurer  
 Micro cucchiari, Micro Sonde per misurare

## Otologie

Otology  
 Otología  
 Otologie  
 Otologia



1/2

1/1

36-038-01-07

Markierung bis  
 Marking up to  
 Manchar hasta  
 Marquage jusque  
 Marcatura fino a  
**3,5 mm**

36-038-02-07

Markierung bis  
 Marking up to  
 Manchar hasta  
 Marquage jusque  
 Marcatura fino a  
**4,0 mm**

36-038-03-07

Markierung bis  
 Marking up to  
 Manchar hasta  
 Marquage jusque  
 Marcatura fino a  
**4,5 mm**

House

36-038-01-07 -  
 36-038-03-07

15,5 cm / 6 1/8"

36



1/2



Ø 1,0 mm

36-044-01-07

Ø 1,2 mm

1/1



Ø 1,5 mm

36-044-02-07

Ø 1,8 mm

1/1



Ø 1,0 mm

36-044-03-07

Ø 1,2 mm

1/1

House

36-044-01-07 -  
 36-044-03-07

14,5 cm / 5 7/8"

## Ohrspekula

Ear Specula

Espéculos auriculares

Spéculums auriculaires

Specoli auricolari

St



1/2

0

1

2

3

4

| Fig. 0       | Fig. 1       | Fig. 2       | Fig. 3       | Fig. 4       |
|--------------|--------------|--------------|--------------|--------------|
| Ø 3,0 mm     | Ø 4,0 mm     | Ø 5,0 mm     | Ø 6,0 mm     | Ø 7,5 mm     |
| 36-112-10-01 | 36-112-11-01 | 36-112-12-01 | 36-112-13-01 | 36-112-14-01 |

Hartmann

36-112-03-01 -

36-115-04-01

3,6 cm / 1 3/8"

| Fig. 0 - 2   | Fig. 2 - 4  | Fig. 1 - 4  |
|--|---|---|
| 36-112-03-01   | 36-114-03-01  | 36-115-04-01  |
| Ohrspekula, Satz,<br>Ear Specula, set<br>Espéculos auriculares, juego<br>Spéculums auriculaires, jeu<br>Specoli auricolari, set<br><br>für Kinder<br>for children<br>para niños<br>pour enfants<br>per bambini | Ohrspekula, Satz,<br>Ear Specula, set<br>Espéculos auriculares, juego<br>Spéculums auriculaires, jeu<br>Specoli auricolari, set<br><br>für Erwachsene<br>for adults<br>para adultos<br>pour adultes<br>per adulti | Ohrspekula, Satz,<br>Ear Specula, set<br>Espéculos auriculares, juego<br>Spéculums auriculaires, jeu<br>Specoli auricolari, set<br><br>für Erwachsene<br>for adults<br>para adultos<br>pour adultes<br>per adulti |

St



1/2

1/2

1

2

3

4

| Fig. 1       | Fig. 2       | Fig. 3       | Fig. 4       |
|--------------|--------------|--------------|--------------|
| Ø 4,0 mm     | Ø 5,0 mm     | Ø 6,0 mm     | Ø 7,5 mm     |
| 36-118-11-01 | 36-118-12-01 | 36-118-13-01 | 36-118-14-01 |

Toynbee

36-118-03-01 -

36-119-04-01

3,6 cm / 1 3/8"

| Fig. 2 - 4  | Fig. 1 - 4  |
|---|---|
| 36-118-03-01  | 36-119-04-01  |
| Ohrspekula, Satz,<br>Ear Specula, set<br>Espéculos auriculares, juego<br>Spéculums auriculaires, jeu<br>Specoli auricolari, set<br><br>für Erwachsene<br>for adults<br>para adultos<br>pour adultes<br>per adulti | Ohrspekula, Satz,<br>Ear Specula, set<br>Espéculos auriculares, juego<br>Spéculums auriculaires, jeu<br>Specoli auricolari, set<br><br>für Erwachsene<br>for adults<br>para adultos<br>pour adultes<br>per adulti |

## Ohrspekula

Ear Specula  
Espéculos auriculares  
Spéculums auriculaires  
Specoli auricolari

## Otologie

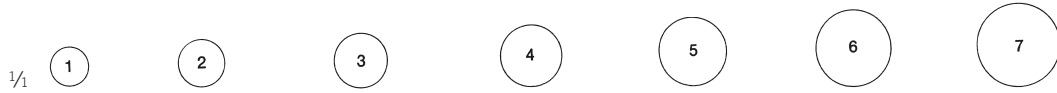
Otology  
Otología  
Otologie  
Otologia



St  
18/8



1/2



| Fig. 1       | Fig. 2       | Fig. 3       | Fig. 4       | Fig. 5       | Fig. 6       | Fig. 7       |
|--------------|--------------|--------------|--------------|--------------|--------------|--------------|
| Ø 5,5 mm     | Ø 6,5 mm     | Ø 7,5 mm     | Ø 8,5 mm     | Ø 9,5 mm     | Ø 10,5 mm    | Ø 11,5 mm    |
| 36-134-01-07 | 36-134-02-07 | 36-134-03-07 | 36-134-04-07 | 36-134-05-07 | 36-134-06-07 | 36-134-07-07 |

## Farrior

36-134-01-07 -

36-134-07-07

3,6 cm / 1 3/8"

rund  
round  
redondo  
ronde  
rotondo



1/2

## 36-148-12-01

Ohrspekulaständer  
Ear Specula Storage Rack  
Soporte para espéculos auriculares  
Support pour spéculums auriculaires  
Supporto per specoli auricolari

# Stimmgabeln

Tuning Forks

Diapasónes

Diapasons

Diapason



1/2

French  
36-170-07-04

**C<sub>2</sub> 16**



1/2

French  
36-172-08-04

**C<sub>1</sub> 32**



1/2

Hartmann  
36-174-09-04

**C 64**



1/2

Hartmann  
36-175-10-04

**C 128**



1/2

Hartmann  
36-177-11-04

**C<sup>1</sup> 256**



# Stimmgabeln


Tuning Forks  
Diapasónes  
Diapasons  
Diapason

# Otologie

Otology  
Otología  
Otologie  
Otologia



1/2

Martin  
36-180-10-04   
**C 128**



1/2

Martin  
36-182-11-04   
**C 256**



1/2

Martin-Alloy  
36-184-12-04   
**C 512**



1/2

Martin-Alloy  
36-186-13-04   
**C 1024**



1/2

Martin-Alloy  
36-188-14-04   
**C 2048**

36



1/2

Hartmann  
36-189-10-04  
**C 128**



1/2

Hartmann  
36-192-11-04  
**C¹ 256**



1/2

Hartmann  
36-194-12-04  
**C² 512**



1/2

Hartmann  
36-196-13-04  
**C³ 1024**



1/2

Hartmann  
36-198-14-04  
**C⁴ 2048**



1/2

Hartmann  
36-200-15-04  
**C⁵ 4096**

# Stimmgabeln

Tuning Forks

Diapasónes

Diapasons

Diapason



Lucae  
36-210-10-04  
**C 128**



Lucae  
36-212-11-04  
**C1 256**



Lucae  
36-214-12-04  
**C2 512**



Lucae  
36-216-13-04  
**C3 1024**



Lucae  
36-218-14-04  
**C4 2048**



Lucae  
36-220-15-04  
**C5 4096**

36-216-90-98

Fuss, allein  
Socket, only  
Pedestal, suelto  
Socle, seul  
Zoccolo, solo

1/2



1/1

36-221-91-98

Fuss, allein  
Socket, only  
Pedestal, suelto  
Socle, seul  
Zoccolo, solo

Lucae  
36-221-10-04 - 36-221-91-98

**C 128**

verschiebbar bis h  
moveable up to h  
regulable hasta h  
réglable jusqu'à h  
regolabile fino a h



1/1

Hartmann  
36-222-10-04

**C 128**

verschiebbar bis h  
moveable up to h  
regulable hasta h  
réglable jusqu'à h  
regolabile fino a h



1/2

36-223-90-98

Fuss, allein  
Socket, only  
Pedestal, suelto  
Socle, seul  
Zoccolo, solo

Hartmann  
36-223-11-04 - 36-223-90-98

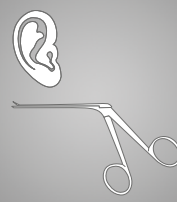
**C1 256**

## Stimmgabeln

Tuning Forks  
Diapasones  
Diapasons  
Diapason

## Otologie

Otology  
Otología  
Otologie  
Otologia



36-224-90-98

Dämpfer  
Dampfer  
Sordina  
Curseur  
Sordina  
weiße Skala  
white scale  
balanza blanca  
l'échelle graduée blanche  
scala bianca



36-224-10-04

36-224-91-98

Dämpfer  
Dampfer  
Sordina  
Curseur  
Sordina  
schwarze Skala  
black scale  
balanza negra  
l'échelle graduée noire  
scala nera



36-224-10-04

36-224-92-98

Rändelschraube  
Knurled screw  
Tornillo moleteado  
Vis moletée  
testa zigrinata



36-224-10-04

36-224-93-98

Gewichte, C 64  
Weights, C 64  
Pesas, C 64  
Poids, C 64  
Pesi, C 64



36-224-10-04



1/2

1/2

1/2

1/2

Rydel-Seiffert  
36-224-10-04

**C 64 / c 128**

auch für Neurologie  
also for neurology  
también para neurología  
aussi pour la neurologia  
anche per neurologia

Neuro  
36-226-00-04

mit Hammer, Nadelrad, Pinsel und Nadel  
with hammer, pinwheel, brush and needle  
con martillo, rueda con espinas, cepillo y aguja  
avec marteaux, roue aux épines, brosette et aiguille  
con martello, algesimetro, pennello ed ago

König  
36-230-59-04

**A 109**

verschiebbar bis g  
moveable up to g  
regulable hasta g  
réglable jusqu'à g  
regolabile fino a g

36-234-90-98

Bakelitfuß  
Bakelit base  
Base de Bakelit  
Base de Bakelit  
Base di Bakelit



36-234-61-04

36-234-61-04

**a<sup>1</sup> 440**

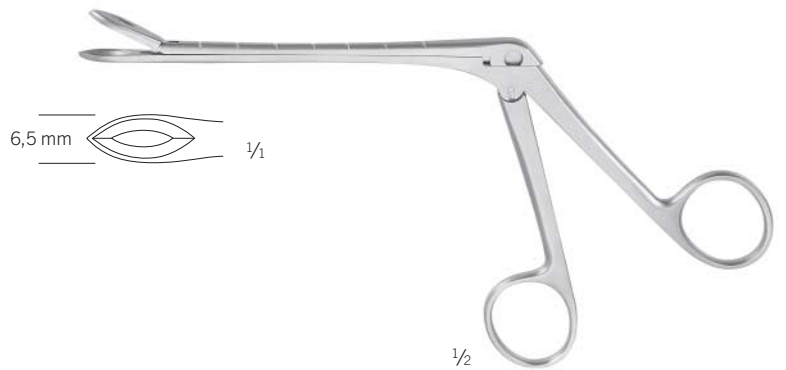
# Ohrkatheter, Polypenschnürer

Ear Catheters, Polypus Snares  
 Sondas auriculares, Polipótomos  
 Sondes auriculaires, Serre-noeuds  
 Sonde auricolari, Serranodi



| Fig. 1       | Fig. 2       | Fig. 3       |
|--------------|--------------|--------------|
| Ø 3,0 mm     | Ø 3,5 mm     | Ø 4,0 mm     |
| 36-321-01-01 | 36-321-02-01 | 36-321-03-01 |

Hartmann  
 36-321-01-01 -  
 36-321-03-01  
 15 cm / 5 7/8"



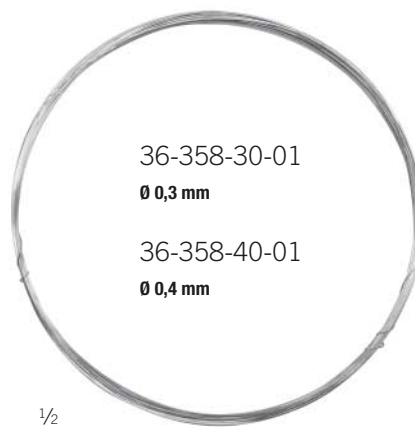
36-316-11-07  
 Schaftlänge  
 shaft length  
 longitud del vástago  
 longueur de la tige  
 lunghezza dell'asta  
**110 mm**



Krause  
 36-351-16-07  
 18,5 cm / 7 2/8"  
 offenes Ende  
 open tip  
 punta abierta  
 pointe ouverte  
 punta aperta



Krause-Voss  
 36-353-16-07  
 18,5 cm / 7 2/8"  
 geschlossenes Ende  
 closed tip  
 punta cerrada  
 pointe fermée  
 punt chiusa



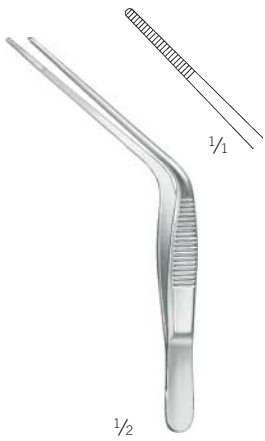
36-358-30-01  
 Ø 0,3 mm  
 36-358-40-01  
 Ø 0,4 mm  
 36-358-30-01 -  
 36-358-40-01  
 Schnürdraht, Rolle mit 10 m  
 Snare Wire, coil of 10 m  
 Alambre, rollo de 10 m  
 Serre-noeuds, en rouleaux de 10 m  
 Filo in acciaio, rotolo di 10 m

## Ohrpinzetten

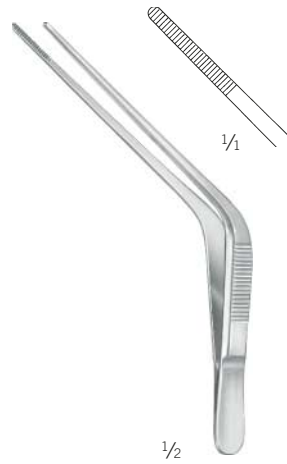
Ear Forceps  
Pinzas auriculares  
Pincas auriculaires  
Pinze auricolari

## Otologie

Otology  
Otología  
Otologie  
Otologia



Tröltsch (Wilde)  
36-371-11-07  
10,5 cm / 4 1/8"



Tröltsch (Wilde)  
36-375-12-07  
11 cm / 4 3/8"



Tröltsch (Wilde)  
36-381-13-07  
12,5 cm / 4 7/8"



Grünwald  
36-391-14-07  
14,5 cm / 5 7/8"



Jansen  
36-395-16-07  
16 cm / 6 2/8"  
36-395-20-07  
21,5 cm / 8 4/8"

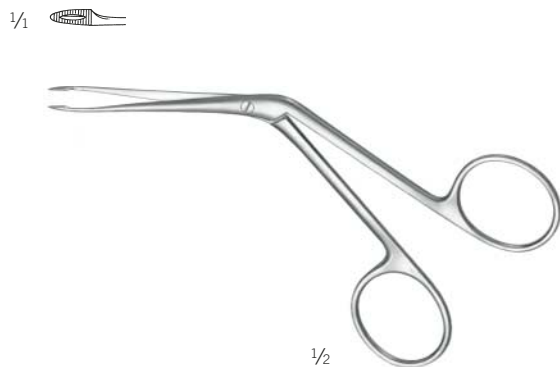
## Ohrpolypenzangen

Ear Polypus Forceps

Pinzas para pólipos auriculares

Pinces pour polypes auriculaires

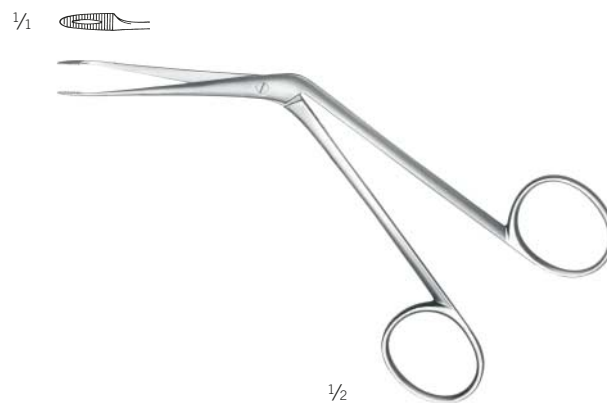
Pinze per polipi auricolari



Hartmann  
36-405-12-07

|                  |                      |
|------------------|----------------------|
| feines Modell    | Schaftlänge          |
| delicate pattern | shaft length         |
| modelo delicado  | longitud del vástago |
| modèle fin       | longueur de la tige  |
| modello fino     | lunghezza dell'asta  |

**65 mm**



Hartmann  
36-407-14-07

|                 |                      |
|-----------------|----------------------|
| normales Modell | Schaftlänge          |
| regular model   | shaft length         |
| modelo regular  | longitud del vástago |
| modèle normal   | longueur de la tige  |
| modello normale | lunghezza dell'asta  |

**65 mm**



Buck  
36-416-11-07

11,5 cm / 4 1/8"

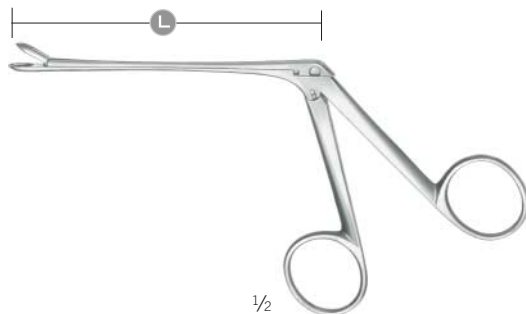
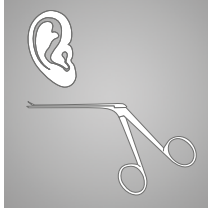
|                                 |
|---------------------------------|
| Fremdkörperzängchen             |
| Foreign Body Lever              |
| Elevador para cuerpos extraños  |
| Pince pour polypes auriculaires |
| Pinza per corpi estranei        |

# Ohrpolypenzangen

Ear Polypus Forceps  
 Pinzas para pólipos auriculares  
 Pincas pour polypes auriculaires  
 Pinze per polipi auricolari

# Otologie

Otology  
 Otología  
 Otologie  
 Otologia



36-425-08-07 -  
 36-456-08-07

|          |                           |                           |
|----------|---------------------------|---------------------------|
|          | <b>Hartmann-Wullstein</b> | <b>Hartmann-Wullstein</b> |
| 1/1      |                           |                           |
| <b>L</b> | <b>8,5 cm</b>             | <b>8,5 cm</b>             |
|          | 36-425-08-07              | 36-427-08-07              |

|          |                 |                 |
|----------|-----------------|-----------------|
|          | <b>Hartmann</b> | <b>Hartmann</b> |
| 1/1      |                 |                 |
| <b>L</b> | <b>8,5 cm</b>   | <b>14 cm</b>    |
|          | 36-430-08-07    | 36-430-14-07    |

|          |                          |                          |                          |
|----------|--------------------------|--------------------------|--------------------------|
|          | <b>Hartmann-Herzfeld</b> | <b>Hartmann-Herzfeld</b> | <b>Hartmann-Herzfeld</b> |
| 1/1      | <br>○ Ø 2,0 mm           | <br>○ Ø 2,5 mm           | <br>○ Ø 3,0 mm           |
| <b>L</b> | <b>8,5 cm</b>            | <b>8,5 cm</b>            | <b>8,5 cm</b>            |
|          | 36-442-81-07             | 36-442-82-07             | 36-442-83-07             |

|          |                           |                 |   |
|----------|---------------------------|-----------------|---|
|          | <b>Hartmann-Wullstein</b> | <b>Strümpel</b> | <b>Hartmann-Hoffmann</b><br>durchschneidend<br>through-cutting<br>cortante<br>tranchante<br>tagliante |
| 1/1      | <br>○ Ø 3,0 mm            |                 | <br>○ Ø 2,0 mm  |
| <b>L</b> | <b>8,5 cm</b>             | <b>8,5 cm</b>   | <b>8,5 cm</b>   |
|          | 36-445-08-07              | 36-448-08-07    | 36-456-08-07  |

## Ohr-Knochenstanzen

Mastoid Rongeurs

Pinzas cortantes para huesos

Ostéotomes emporte-pièces

Pinze osteotomi



1/2

Citelli  
36-461-17-07

|  |     |   |
|--|-----|---|
| <b>Maulbreite</b><br><b>Jaw width</b><br><b>Anchura de la boca</b><br><b>Largeur de mors</b><br><b>Larghezza della bocca</b> |     | <b>aufgewinkelt</b><br><b>angled upward</b><br><b>acodado arrib</b><br><b>angulé vers le haut</b><br><b>angolato verso l'alto</b> |
|  | 1/1 |   |
|  | L   | <b>7,5 cm</b>   |
| <b>3 mm</b>  |     | 36-461-17-07  |

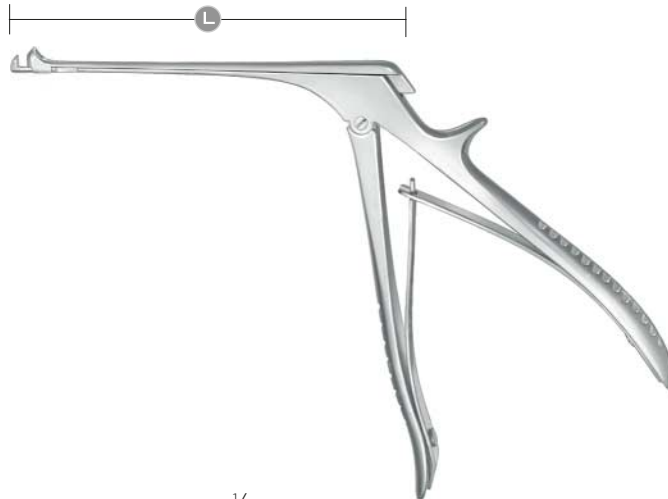
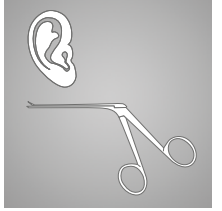


## Ohr-Knochenstanzen

Mastoid Rongeurs  
 Pinzas cortantes para huesos  
 Ostéotomes emporte-pièces  
 Pinze osteotomi

## Otologie


Otology  
 Otología  
 Otologie  
 Otologia



1/2

Beyer  
 36-463-19-07 -  
 36-466-14-07

36

| Maulbreite<br>Jaw width<br>Anchura de la boca<br>Largeur de mors<br>Larghezza della bocca |     | aufgewinkelt<br>angled upward<br>acodado arrib<br>angulé vers le haut<br>angolato verso l'alto |
|---|-----|--|
|   | 1/4 |             |
|   | L   | <b>9,5 cm</b>  |
| 1 mm  | C   | 36-466-14-07   |
| 2 mm  | C   | 36-463-19-07   |

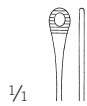
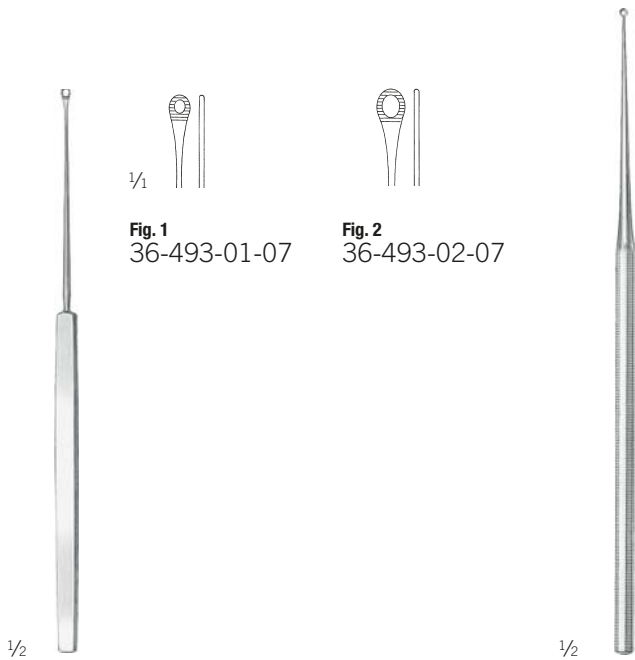
# Ohrküretten

Ear Cures

Curetas auriculares

Curettes auriculaires

Curette auricolari



**Fig. 1**  
36-493-01-07



**Fig. 2**  
36-493-02-07



|              |                |                 |
|--------------|----------------|-----------------|
| 36-495-02-07 | <b>Fig. 00</b> | <b>Ø 2,1 mm</b> |
| 36-495-10-07 | <b>Fig. 0</b>  | <b>Ø 2,6 mm</b> |
| 36-495-11-07 | <b>Fig. 1</b>  | <b>Ø 3,2 mm</b> |
| 36-495-12-07 | <b>Fig. 2</b>  | <b>Ø 3,7 mm</b> |

Shapleigh  
36-493-01-07 -  
36-493-02-07  
15 cm / 5 7/8"

Buck  
36-495-02-07 -  
36-495-12-07  
17 cm / 6 5/8"  
stumpf  
blunt  
romo  
mousse  
smusso



stumpf  
blunt  
romo  
mousse  
smusso



|              |                 |                 |
|--------------|-----------------|-----------------|
| 36-497-01-07 | <b>Fig. 000</b> | <b>Ø 1,8 mm</b> |
| 36-497-02-07 | <b>Fig. 00</b>  | <b>Ø 2,1 mm</b> |
| 36-497-10-07 | <b>Fig. 0</b>   | <b>Ø 2,6 mm</b> |
| 36-497-11-07 | <b>Fig. 1</b>   | <b>Ø 3,2 mm</b> |
| 36-497-12-07 | <b>Fig. 2</b>   | <b>Ø 3,7 mm</b> |
| 36-497-13-07 | <b>Fig. 3</b>   | <b>Ø 4,1 mm</b> |
| 36-497-14-07 | <b>Fig. 4</b>   | <b>Ø 4,4 mm</b> |

scharf  
sharp  
agudo  
pointu  
acuto



|              |                 |                 |
|--------------|-----------------|-----------------|
| 36-498-01-07 | <b>Fig. 000</b> | <b>Ø 1,8 mm</b> |
| 36-498-02-07 | <b>Fig. 00</b>  | <b>Ø 2,1 mm</b> |
| 36-498-10-07 | <b>Fig. 0</b>   | <b>Ø 2,6 mm</b> |
| 36-498-11-07 | <b>Fig. 1</b>   | <b>Ø 3,2 mm</b> |
| 36-498-12-07 | <b>Fig. 2</b>   | <b>Ø 3,7 mm</b> |
| 36-498-13-07 | <b>Fig. 3</b>   | <b>Ø 4,1 mm</b> |
| 36-498-14-07 | <b>Fig. 4</b>   | <b>Ø 4,4 mm</b> |

Buck  
36-497-01-07 -  
36-498-14-07  
15 cm / 6 5/8"

# Ohrlöffel, Fremdkörperinstrumente

Ear Scoop, Foreign Body Instruments

Cucharilla auricular, Instrumentos para cuerpos extraños

Curette auriculaire, Instruments pour corps étrangers

Curetta auricolare, Strumenti per corpi estranei

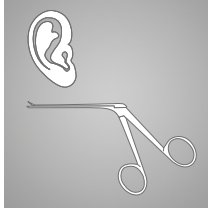
# Otologie

Otology

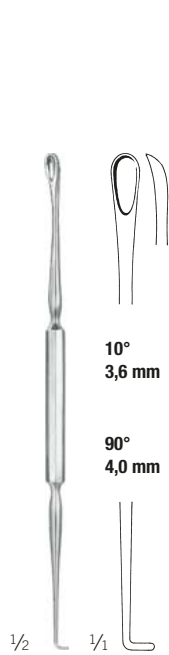
Otología

Otologie

Otologia



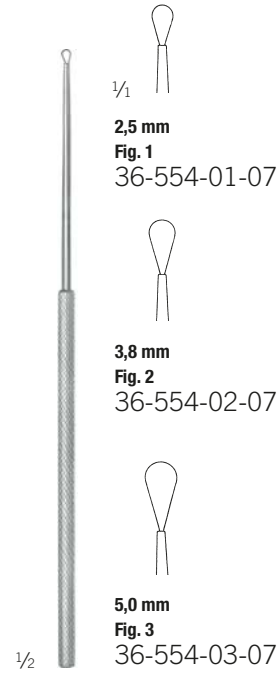
**Jansen**  
36-532-15-07  
16 cm / 6 2/8"  
scharf  
sharp  
agudo  
pointu  
acuto



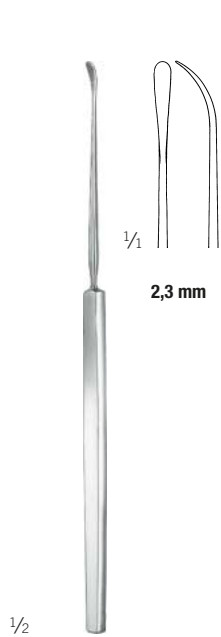
**Gross**  
36-543-12-07  
13 cm / 5 1/8"  
stumpf  
blunt  
romo  
mousse  
smusso



**Weber-Loch**  
36-551-01-07  
17 cm / 6 5/8"  
stumpf  
blunt  
romo  
mousse  
smusso



**Billeau**  
36-554-01-07 -  
36-554-03-07  
16,5 cm / 6 1/8"



**Zaufal**  
36-563-16-07  
15 cm / 5 7/8"  
Fremdkörperhebel  
Foreign Body Lever  
Elevador para cuerpos extraños  
Anse auriculaire  
Leva per corpi estranei



**Hartmann**  
36-570-16-07  
16 cm / 6 2/8"  
Ohrhäkchen  
Ear Hooklet  
Ganchito auricular  
Levier pour corps étrangers  
Uncino auricolare



**Lucae**  
36-577-01-07 -  
36-577-03-07  
14 cm / 5 4/8"

| Ø 0,6 mm     | Ø 0,8 mm     | Ø 1,0 mm     |
|--------------|--------------|--------------|
| 2,3 mm       | 3,1 mm       | 4,2 mm       |
| 90°          | 90°          | 90°          |
| Fig. 1       | Fig. 2       | Fig. 3       |
| 36-577-01-07 | 36-577-02-07 | 36-577-03-07 |

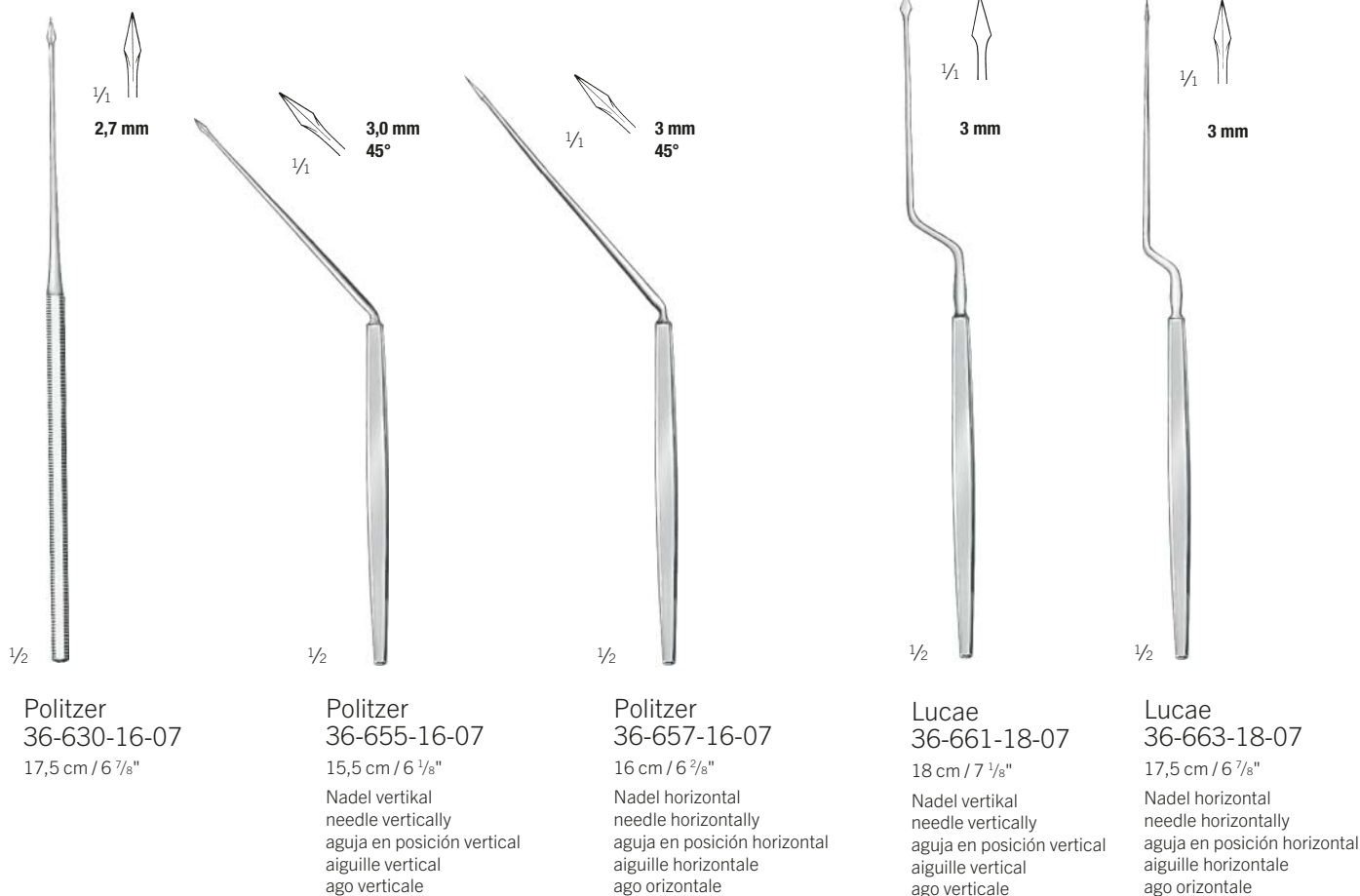
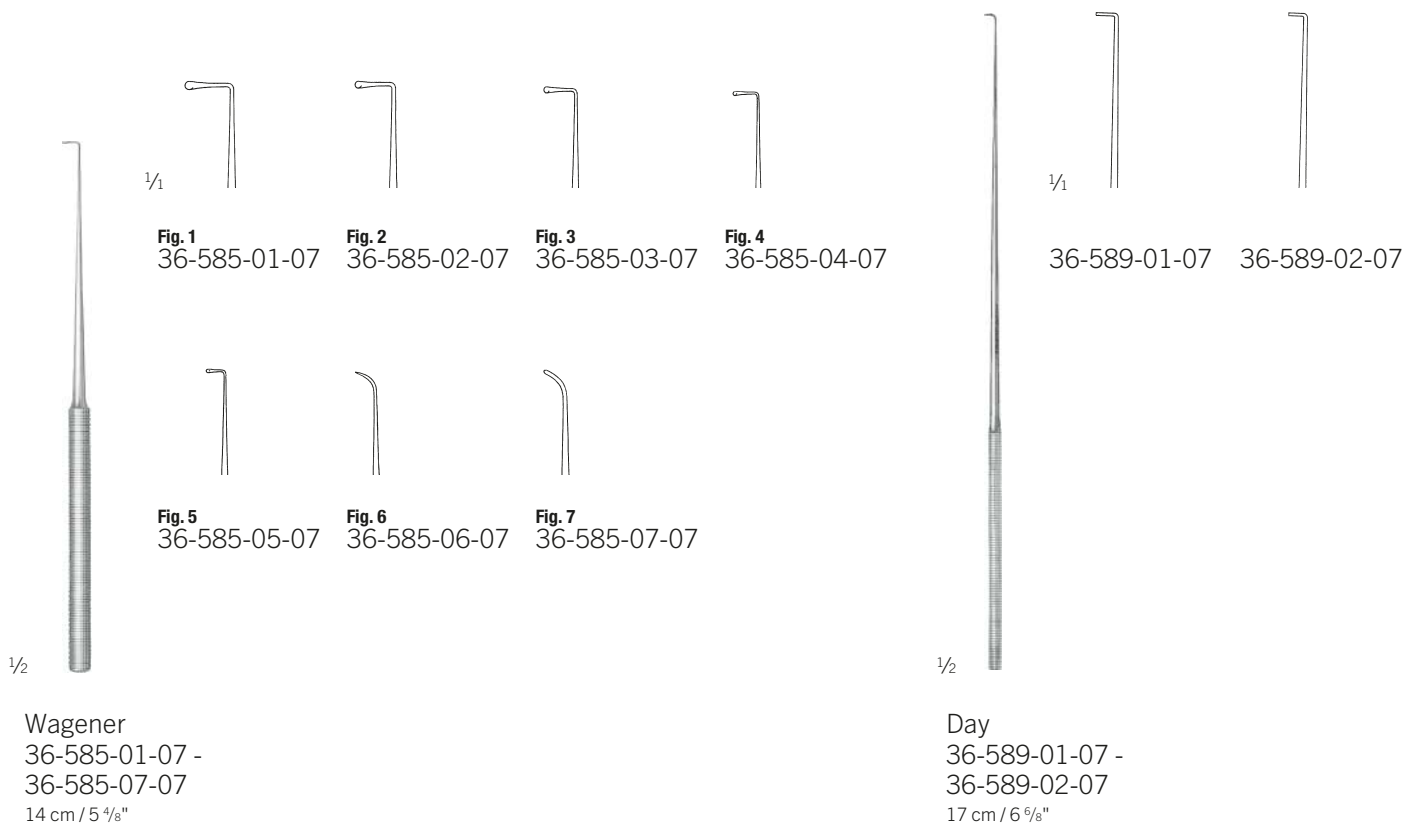
# Ohrhäkchen, Trommelfellnadeln

Ear Hooklet, Tympanum Needles

Ganchito auricular, Agujas para tímpano

Levier pour corps étrangers, Instruments pour corps étrangers

Uncino auricolare, Strumenti per corpi estranei



## Ohrraspatorien, Ohrlöffel

Ear Periosteal Elevators, Ear Scoop

Legras auriculares, Cucharilla auricular

Rugines-raspatoires auriculaires, Rugine-raspatoire auriculaire

Raspatori auricolari, Curetta auricolare

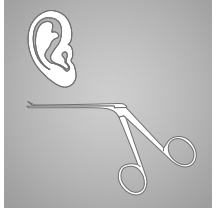
## Otologie

Otology

Otología

Otologie

Otologia



Lempert  
36-737-20-07  
20,5 cm / 8 1/8"



Lempert  
36-739-17-07  
18 cm / 7 1/8"



Lempert  
36-743-10-07 -  
36-743-50-07  
21,5 cm / 8 5/8"  
scharf  
sharp  
agudo  
pointu  
acuto

1/2 0  
1,5 mm  
Fig. 5  
36-743-50-07

0  
2,0 mm  
Fig. 4  
36-743-40-07

0  
2,2 mm  
Fig. 3  
36-743-30-07

0  
2,5 mm  
Fig. 2  
36-743-20-07

0  
2,7 mm  
Fig. 1  
36-743-10-07

## Nasenspekula

Nasal Specula  
Espéculos nasales  
Spéculums nasaux  
Specoli nasali



1/2

Goldsmith (Thudichum)

36-817-01-01 -

36-817-03-01

6,5 cm / 2 1/8"



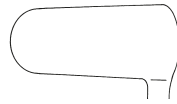
1/1

**Fig. 1**

36-817-01-01

Blätter  
blades  
hojas  
lames  
lame

18,5 x 9,5 mm

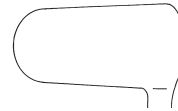


**Fig. 2**

36-817-02-01

Blätter  
blades  
hojas  
lames  
lame

21 x 10,5 mm



**Fig. 3**

36-817-03-01

Blätter  
blades  
hojas  
lames  
lame

21 x 11,5 mm



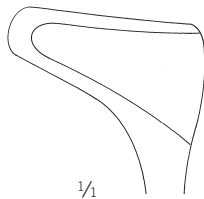
1/2

Hartmann-Halle

36-845-01-07 -

36-845-03-07

16 cm / 6 2/8"



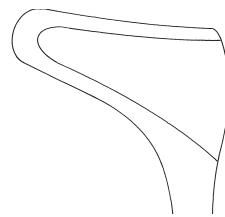
1/1

**Fig. 1**

36-845-01-07

Blätter  
blades  
hojas  
lames  
lame

27 mm

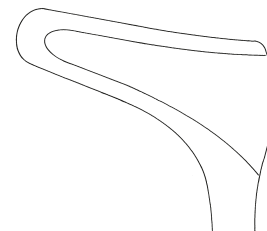


**Fig. 2**

36-845-02-07

Blätter  
blades  
hojas  
lames  
lame

31 mm



**Fig. 3**

36-845-03-07

Blätter  
blades  
hojas  
lames  
lame

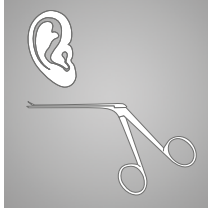
35 mm

# Nasenspekula

Nasal Specula  
Espéculos nasales  
Spéculums nasaux  
Specoli nasali

# Otologie

Otology  
Otología  
Otologie  
Otologie  
Otologie



1/1  
Blätter  
blades  
hojas  
lames  
lame  
**17 mm**

Martin  
36-848-13-07  
13 cm / 5 1/8"



1/1  
Blätter  
blades  
hojas  
lames  
lame  
**17 mm**

Martin  
36-849-13-07  
13 cm / 5 1/8"



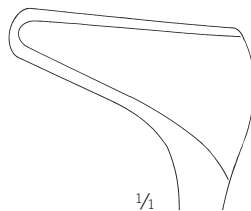
1/1  
Blätter  
blades  
hojas  
lames  
lame  
**16 mm**

Tieck-Halle  
36-852-13-07  
13 cm / 5 1/8"

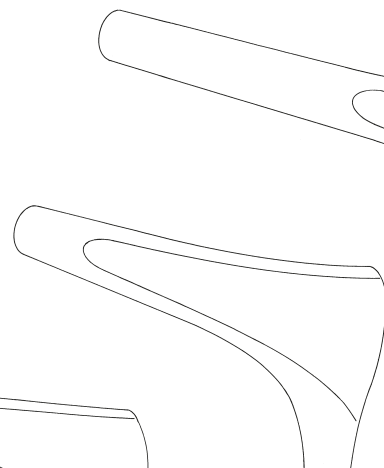


1/2

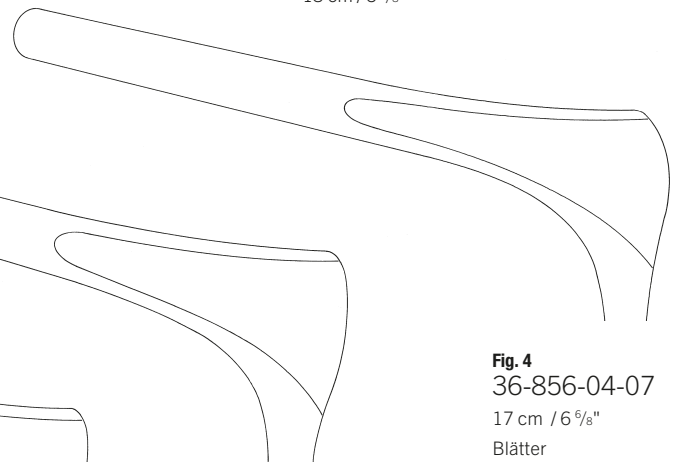
Killian  
36-856-01-07 -  
36-856-04-07



1/1  
**Fig. 1**  
36-856-01-07  
14 cm / 5 4/8"  
Blätter  
blades  
hojas  
lames  
lame  
**35 mm**



**Fig. 2**  
36-856-02-07  
14,5 cm / 5 6/8"  
Blätter  
blades  
hojas  
lames  
lame  
**50 mm**



**Fig. 3**  
36-856-03-07  
16 cm / 6 2/8"  
Blätter  
blades  
hojas  
lames  
lame  
**75 mm**

**Fig. 4**  
36-856-04-07  
17 cm / 6 6/8"  
Blätter  
blades  
hojas  
lames  
lame  
**85 mm**

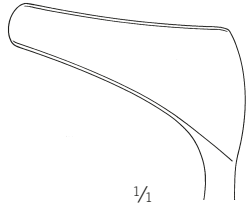
# Nasenspekula

Nasal Specula  
 Espéculos nasales  
 Spéculums nasaux  
 Specoli nasali



1/2

Mod. Wien  
 36-858-14-07  
 13,5 cm / 5 3/8"



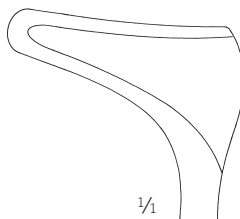
1/1

Blätter  
 blades  
 hojas  
 lames  
 lame  
**30 mm**



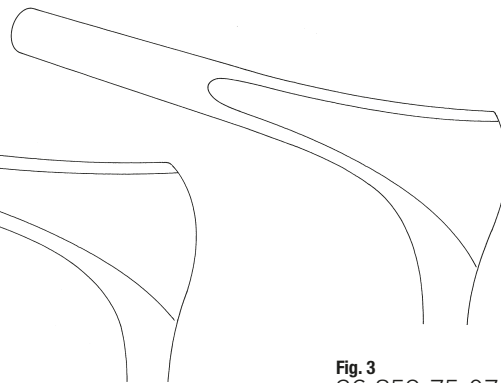
1/2

Cottle  
 36-859-35-07 -  
 36-859-90-07

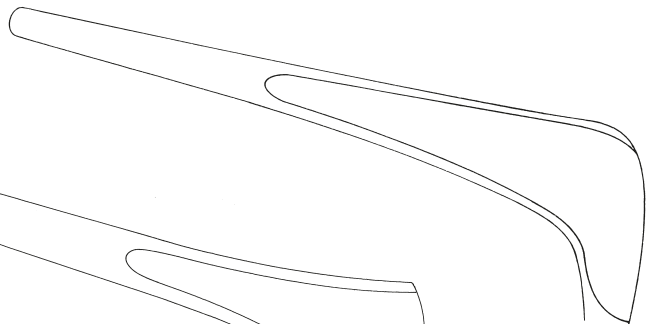


1/1

**Fig. 1**  
 36-859-35-07  
 13,5 cm / 5 3/8"  
 Blätter  
 blades  
 hojas  
 lames  
 lame  
**35 mm**



**Fig. 2**  
 36-859-50-07  
 14 cm / 5 4/8"  
 Blätter  
 blades  
 hojas  
 lames  
 lame  
**50 mm**



**Fig. 3**  
 36-859-75-07  
 16 cm / 6 2/8"  
 Blätter  
 blades  
 hojas  
 lames  
 lame  
**75 mm**

**Fig. 4**  
 36-859-90-07  
 16 cm / 6 2/8"  
 Blätter  
 blades  
 hojas  
 lames  
 lame  
**85 mm**

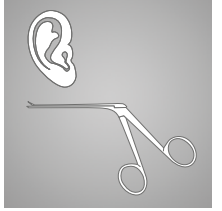


## Nasenspekula

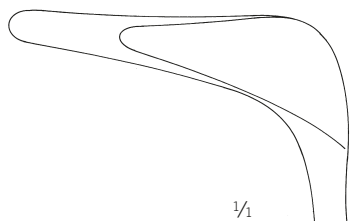
Nasal Specula  
Espéculos nasales  
Spéculums nasaux  
Specoli nasali

## Otologie

Otology  
Otología  
Otologie  
Otologia



36



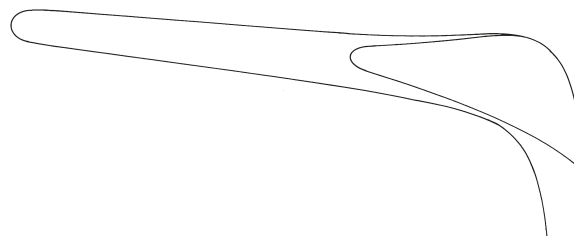
1/1

36-861-45-07

14 cm / 5 4/8"

Blätter  
blades  
hojas  
lames  
lame

45 mm



36-861-75-07

15,5 cm / 6 1/8"

Blätter  
blades  
hojas  
lames  
lame

75 mm



1/2

Cottle

36-861-45-07 -  
36-861-75-07

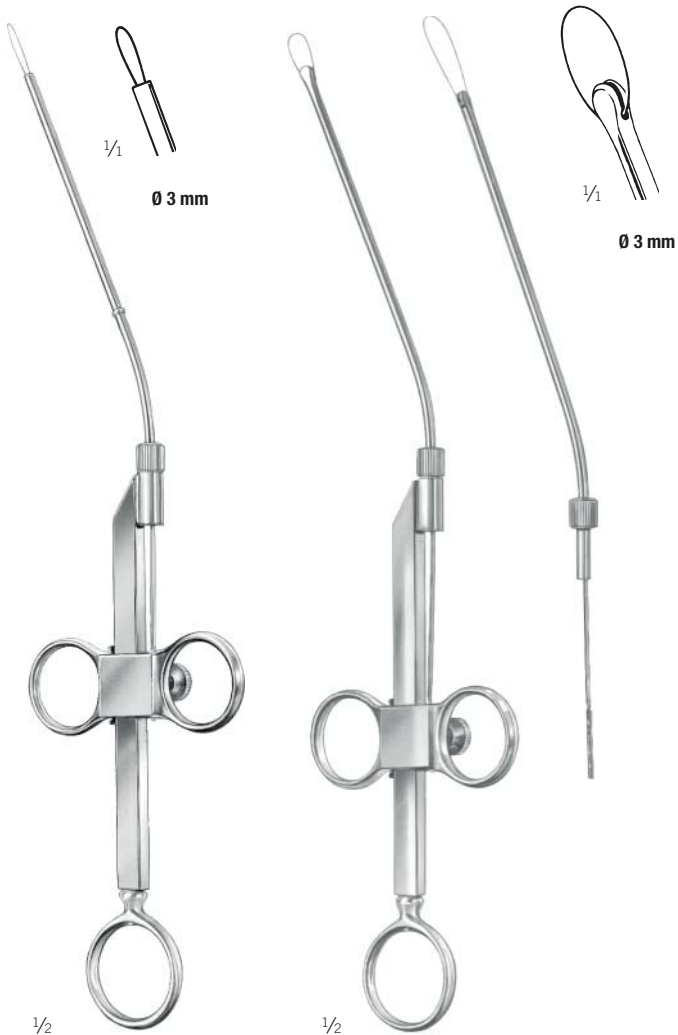
## Polypenschnürer

Polypus Snares

Polipótomos

Serre-noeuds pour polypes

Serranodi per polipi



Krause  
36-885-26-07

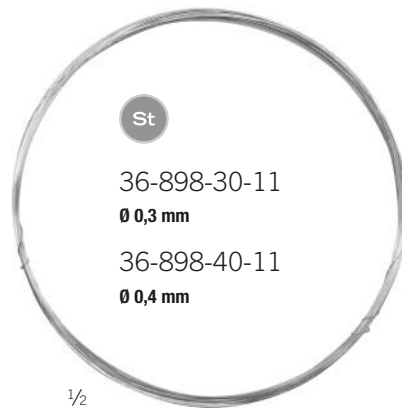
26 cm / 10 <sup>2</sup>/<sub>8</sub>"

Schaft  
shaft  
vástago  
tige  
asta

Krause-Voss  
36-887-26-07

26 cm / 10 <sup>2</sup>/<sub>8</sub>"

Schaft  
shaft  
vástago  
tige  
asta



36-898-30-11 -  
36-898-40-11

Schnürdraht  
Snare Wire  
Asa de alambre  
Anse en fil d'acier  
Filo per allacciare

Rolle mit 10 m  
coil of 10 m  
rollo de 10 m  
en rouleaux de 10 m  
rotolo di 10 m



36-899-12-01

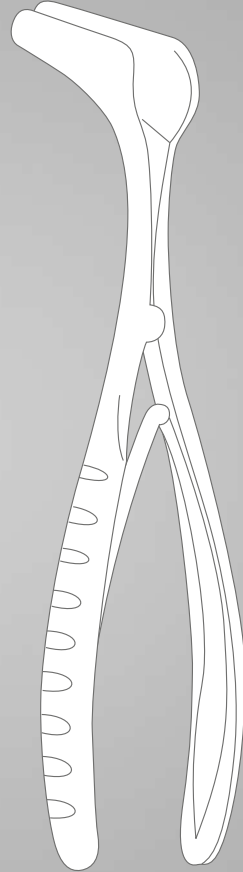
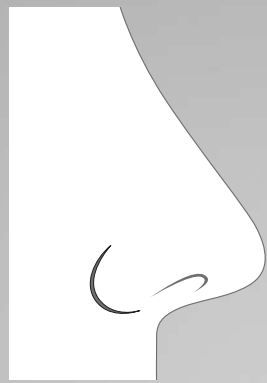
10,5 cm / 4"

Schnürdraht  
Snare Wire  
Asas de alambre  
Anses en fil d'acier  
Filo per allacciare  
0.3 mm

Bündel mit 12 Stück  
bundle with 12 pieces  
12 piezas atados  
paquet de 12 pièces  
confezione di 12 pezzi

Rhinologie  
Rhinology  
Rinología  
Rhinologie  
Rinología

# 37



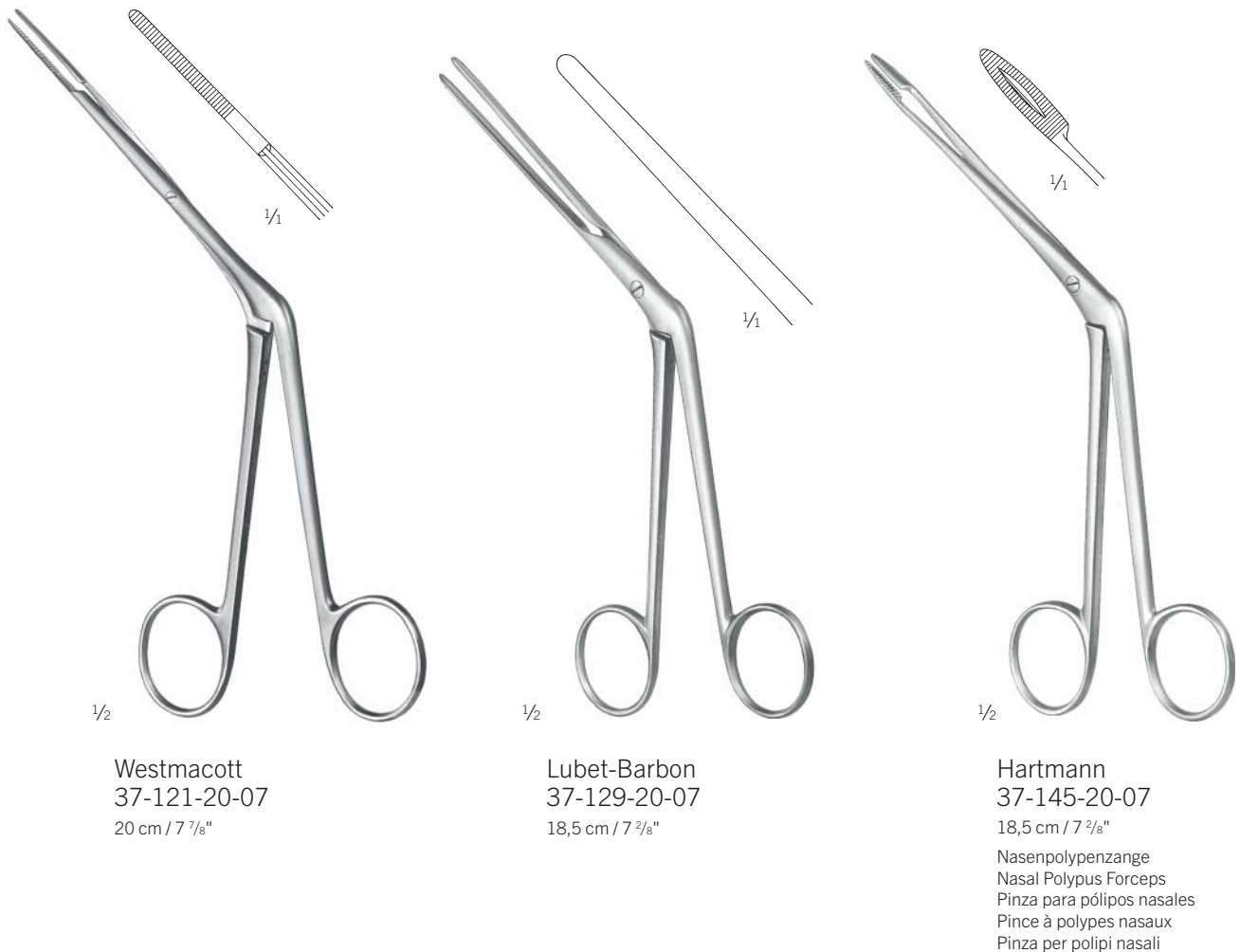
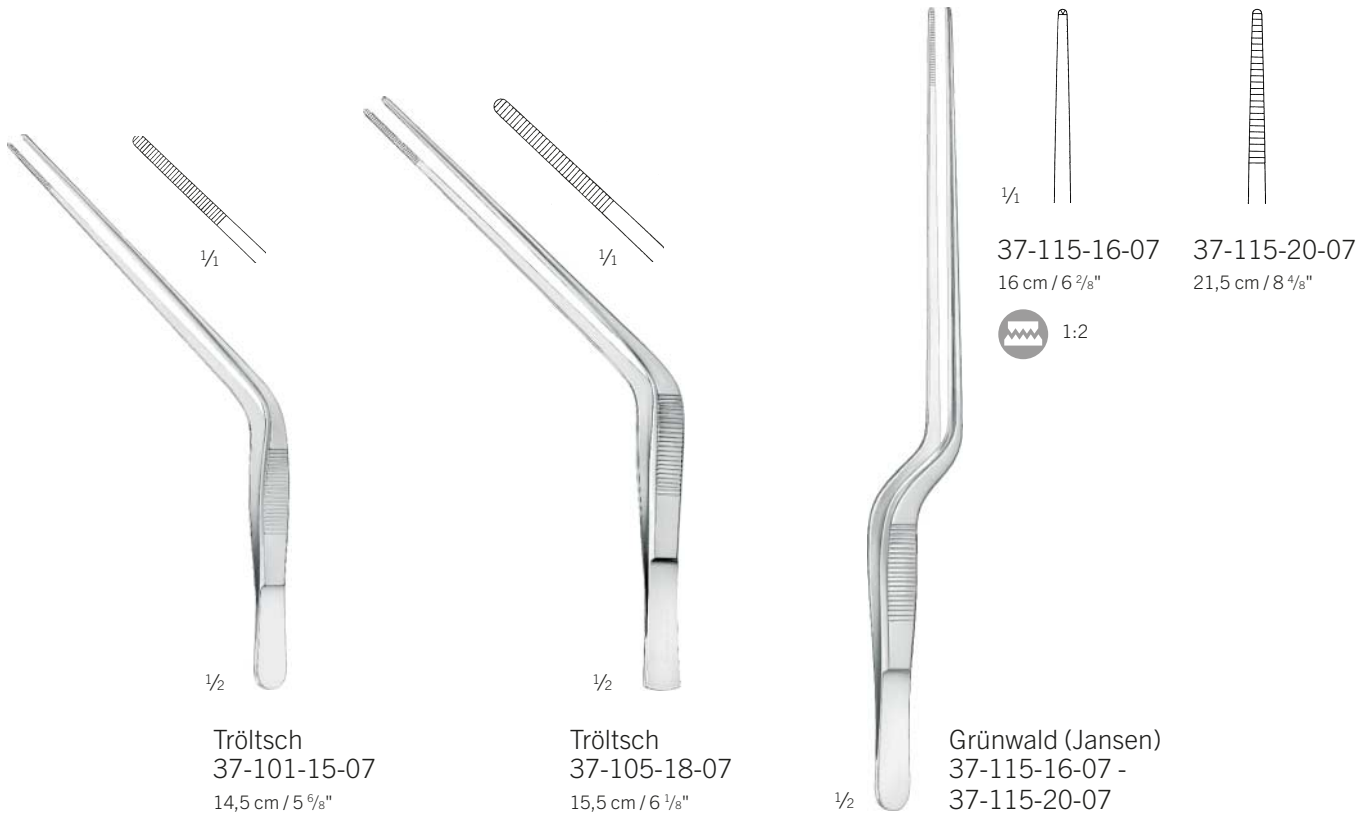
## Nasentamponpinzetten, Nasentamponzangen

Nasal Tampon Forceps, Nasal Tampon Forceps

Pinzas para taponamiento, Pinzas para taponamiento

Pinces à pansements, Pinces à pansements

Pinze per medicature, Pinze per medicature

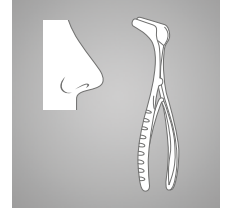


## Septumzangen

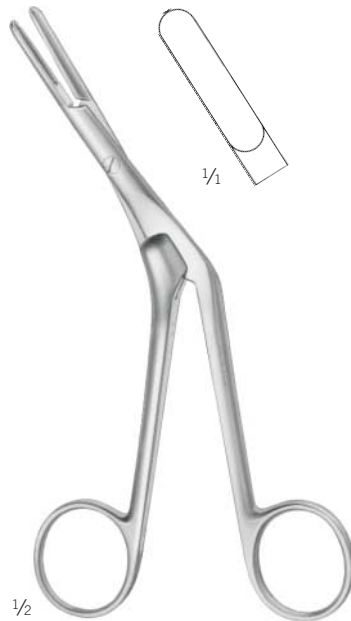
Septum Forceps  
Pinzas para tabique nasal  
Pinces pour la cloison nasale  
Pinze per il setto nasale

## Rhinologie

Rhinology  
Rinología  
Rhinologie  
Rinologia



**5 mm**  
Knight  
37-207-18-07  
17 cm / 6 5/8"



**5,5 mm**  
Graig  
37-213-18-07  
16 cm / 6 2/8"

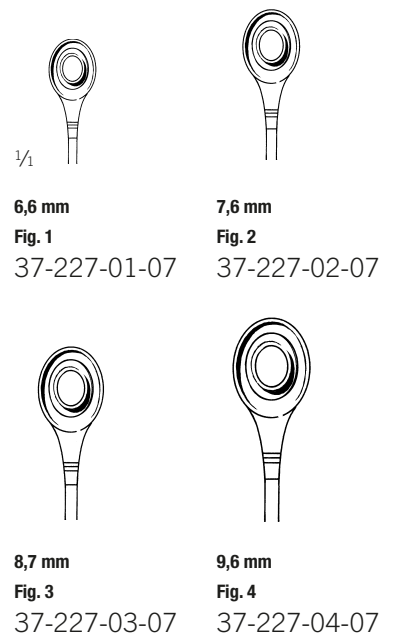


**8,5 mm**  
37-215-01-07  
links gebogen  
left curved  
curvo por izquierdo  
courbé à gauche  
curvo a sinistra

37-215-01-07  
15,5 cm / 6 1/8"



Brünings  
37-227-01-07 -  
37-227-04-07  
16,5 cm / 6 4/8"



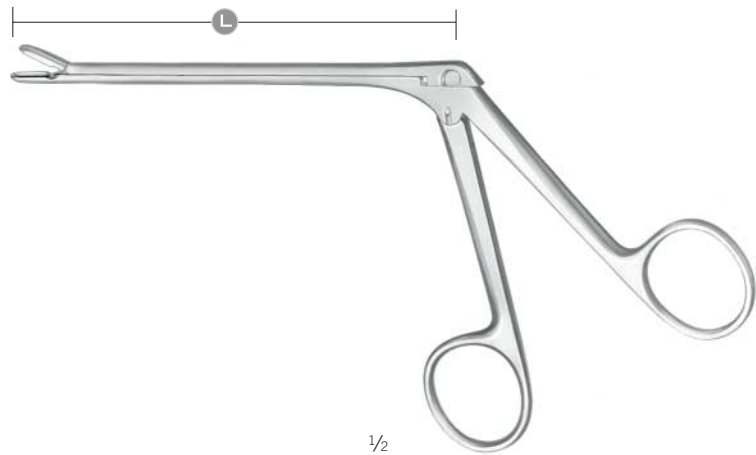
## Siebbeinzangen

Ethmoid Bone Forceps

Pinzas para etmoides

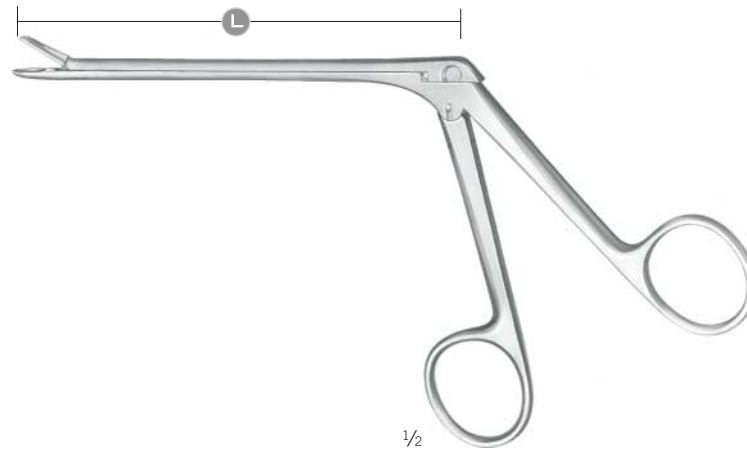
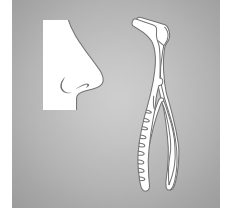
Pinces éthmoidales

Pinze etmoidali






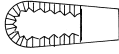


Takahashi  
37-235-12-07 -  
37-237-12-07

| <b>Maulbreite</b><br><b>Jaw width</b><br><b>Anchura de la boca</b><br><b>Largeur de mors</b><br><b>Larghezza della bocca</b> |   | <b>gerade</b><br><b>straight</b><br><b>recto</b><br><b>droit</b><br><b>diritto</b> | <b>45°</b><br><b>aufgewinkelt</b><br><b>angled upward</b><br><b>acodado arrib</b><br><b>angulé vers le haut</b><br><b>angolato verso l'alto</b> |
|--|---|--|---|
|  | <b>3,5 mm</b>  | $\frac{1}{1}$  |    |
|  | <b>L</b>  | <b>12 cm</b>   | <b>12 cm</b>  |
|  |   | 37-235-12-07   | 37-237-12-07  |



**37**

37-241-10-07 -  
 37-249-12-07

|   |   |   |  |  |
|---|---|---|--|--|
| <b>Maul</b><br><b>Jaw</b><br><b>Boca</b><br><b>Mors</b><br><b>Bocca</b> |   | <b>gerade</b><br><b>straight</b><br><b>recto</b><br><b>droit</b><br><b>diritto</b>                            | <b>gerade</b><br><b>straight</b><br><b>recto</b><br><b>droit</b><br><b>diritto</b>   | <b>gerade</b><br><b>straight</b><br><b>recto</b><br><b>droit</b><br><b>diritto</b>                   |
|   | $\frac{1}{1}$   | <br><b>Watson-Williams</b> |  | <br><b>Weil</b> |
|   | <b>L</b>  | <b>12 cm</b>  | <b>12 cm</b>   | <b>12 cm</b>   |
| <b>7,0 mm</b>   |  | 37-241-10-07  |  |  |
| <b>8,0 mm</b>   |  |   | 37-241-12-07   |  |
| <b>5,5 mm</b>   |  |   |  | 37-249-12-07   |

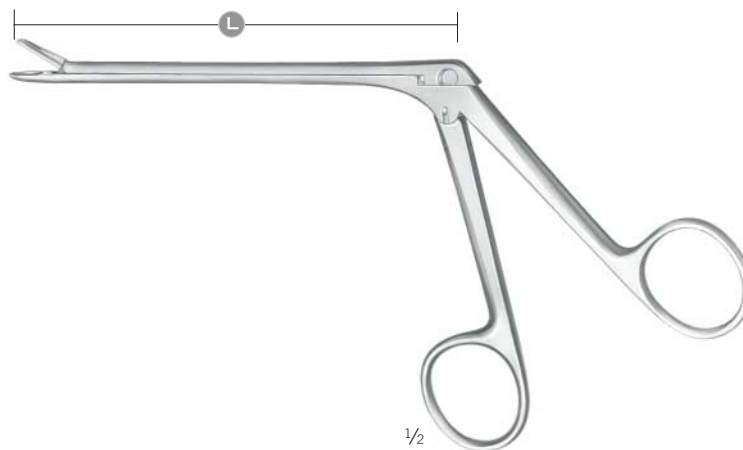
## Scharfe Nasenzangen, Siebbeinzangen

Nasal Cutting Forceps, Ethmoid Bone Forceps









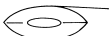



Pinzas nasales cortantes, Pinzas para etmoides

Pinces nasales coupantes, Pinces étmoidales

Pinze taglianti per il naso, Pinze etmoidali



Weil-Blakesley  
37-255-01-07 -  
37-258-04-07

| Maulbreite<br>Jaw width<br>Anchura de la boca<br>Largeur de mors<br>Larghezza della bocca |   | gerade<br>straight<br>recto<br>droit<br>diritto |   | 45°<br>aufgewinkelt<br>angled upward<br>acodado arrib<br>angulé vers le haut<br>angolato verso l'alto |   | 90°<br>aufgewinkelt<br>angled upward<br>acodado arrib<br>angulé vers le haut<br>angolato verso l'alto |   |
|---|---|---|---|---|---|---|---|
|   |   | $\frac{1}{2}$                                   |  | $\frac{1}{2}$   |  | $\frac{1}{2}$   |  |
|   |   | L   | 12 cm   | L   | 12 cm   | L   | 12 cm   |
| Fig. 1<br>3,0 mm  |  |   | 37-255-01-07  | Fig. 1<br>3,0 mm  |    | 37-256-01-07  | 37-258-01-07  |
| Fig. 2<br>3,5 mm  |  |   | 37-255-02-07  | Fig. 2<br>3,5 mm  |    | 37-256-02-07  | 37-258-02-07  |
| Fig. 3<br>4,5 mm  |  |   | 37-255-03-07  | Fig. 3<br>4,5 mm  |    | 37-256-03-07  | 37-258-03-07  |
| Fig. 4<br>5,0 mm  |  |   | 37-255-04-07  | Fig. 4<br>5,0 mm  |    | 37-256-04-07  | 37-258-04-07  |
| Fig. 5<br>6,0 mm  |  |   | 37-255-05-07  |   |   |   |   |

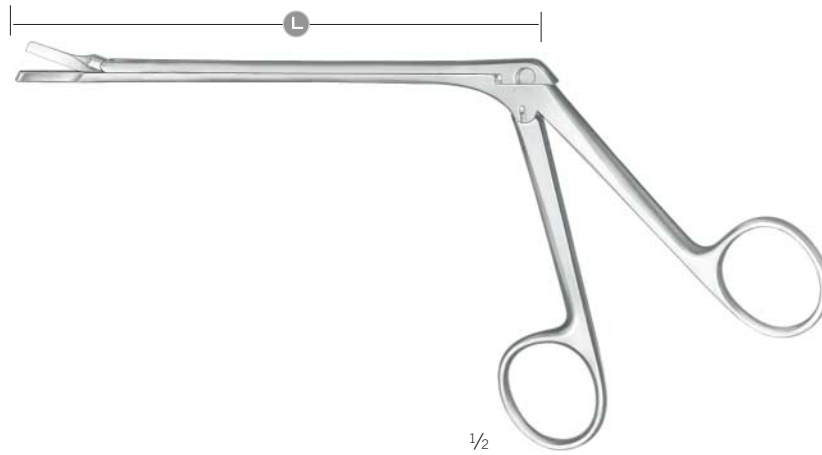
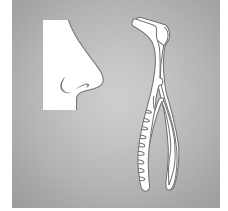


## Scharfe Nasenzange

Nasal Cutting Forceps  
Pinzas nasales cortantes  
Pincas nasales coupantes  
Pinze taglienti per il naso

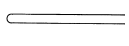

## Rhinologie

Rhinology  
Rinología  
Rhinologie  
Rinologia



Struycken  
37-285-01-07

37

|  |   |
|--|---|
| <b>Maulbreite</b><br>Jaw width<br>Anchura de la boca<br>Largeur de mors<br>Larghezza della bocca | <b>gerade</b><br>straight<br>recto<br>droit<br>diritto  |
| <b>Fig. 1</b><br>1,0 mm  |                |
|  | $\frac{1}{1}$  |
|  | <b>L</b> <b>12 cm</b>   |
|  | 37-285-01-07  |

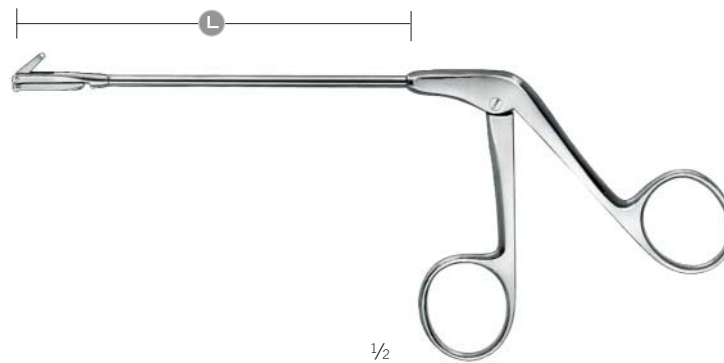
## Antrumstanzen

Antrum Punches

Pinzas sacabocadas para seno maxilar

Pinces emporte-pièces pour sinus maxillaire

Pinze taglienti per seno mascellare



37-308-01-07 -  
37-308-03-07

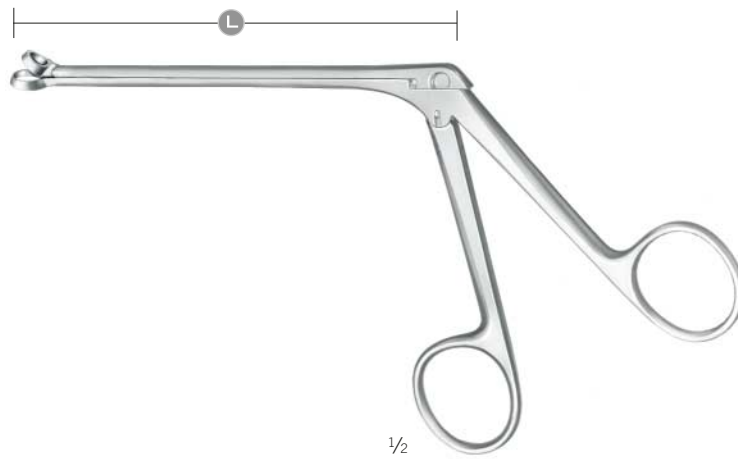
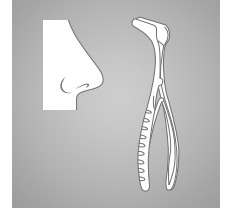
|  |               |  |  |   |
|--|---------------|--|--|---|
| <b>Maulbreite</b><br><b>Jaw width</b><br><b>Anchura de la boca</b><br><b>Largeur de mors</b><br><b>Larghezza della bocca</b> | $\frac{1}{2}$ | <b>retrograd aufwärts schneidend</b><br><b>retrograde, up cutting</b><br><b>retrogrado, cortante en la parte superior</b><br><b>retrograde, coupant en haut</b><br><b>retrogrado, taglio in sù</b> | <b>retrograd rechts schneidend</b><br><b>retrograde, right cutting</b><br><b>retrogrado, cortante a la derecha</b><br><b>retrograde, coupant à droit</b><br><b>retrogrado, taglio destro</b> | <b>retrograd links schneidend</b><br><b>retrograde, left cutting</b><br><b>retrogrado, cortante a la izquierda</b><br><b>retrograde, coupant à gauche</b><br><b>retrogrado, taglio sinistro</b> |
|  |               |  |  |   |
|  | <b>L</b>      | <b>10 cm</b>   | <b>10 cm</b>   | <b>10 cm</b>  |
| <b>2,5 mm</b>  |               | <b>37-308-01-07</b>  | <b>37-308-02-07</b>  | <b>37-308-03-07</b>   |

## Scharfe Nasenzangen

Nasal Cutting Forceps  
 Pinzas nasales cortantes  
 Pincas nasales coupantes  
 Pinze taglienti per il naso






## Rhinologie

Rhinology  
 Rinología  
 Rhinologie  
 Rinologia



Hartmann  
 37-309-01-07 -  
 37-309-04-07

37

|  |   |  |
|--|---|--|
| <b>Maulbreite</b><br><b>Jaw width</b><br><b>Anchura de la boca</b><br><b>Largeur de mors</b><br><b>Larghezza della bocca</b> | $\frac{1}{1}$   | <br><b>Hartmann</b> |
|  |   | <b>L</b> <b>12 cm</b>  |
| <b>Fig. 1</b><br><b>Ø 5,0 mm</b>   |  | 37-309-01-07   |
| <b>Fig. 2</b><br><b>Ø 7,0 mm</b>   |  | 37-309-02-07   |
| <b>Fig. 3</b><br><b>Ø 9,0 mm</b>   |  | 37-309-03-07   |
| <b>Fig. 4</b><br><b>Ø 11,0 mm</b>  |  | 37-309-04-07   |

## Septumzangen, Septumquetschzange

Septum Forceps, Septum Morselizer

Pinzas para tabique nasal, Pinza para aplastamiento

Pinces pour la cloison nasale, Pince-gouge pour la cloison nasale

Pinze per il setto nasale, Pinza contundente per il setto nasale



1/2

durchschneidend  
through-cutting  
cortante  
tranchante  
tagliante

1/2

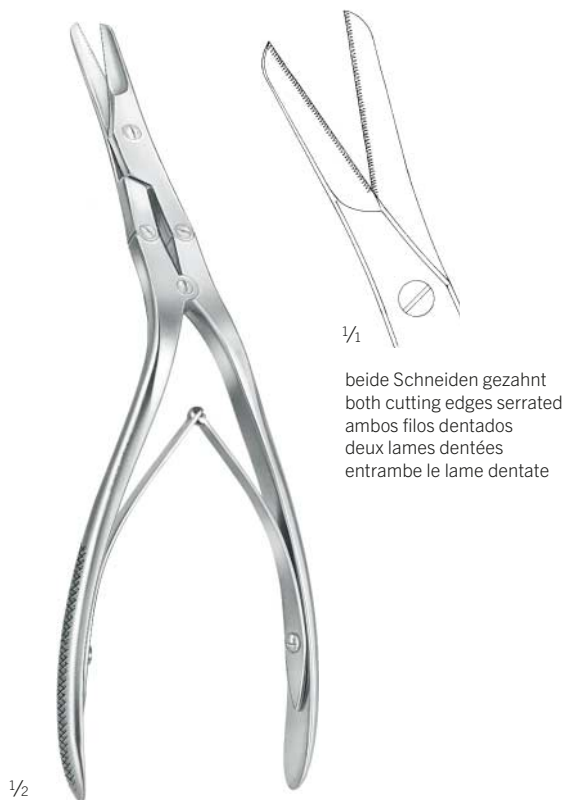
Middleton-Jansen  
37-323-19-07  
20,5 cm / 8 1/8"



1/2

1/2

Middleton-Jansen  
37-327-19-07  
20 cm / 7 7/8"

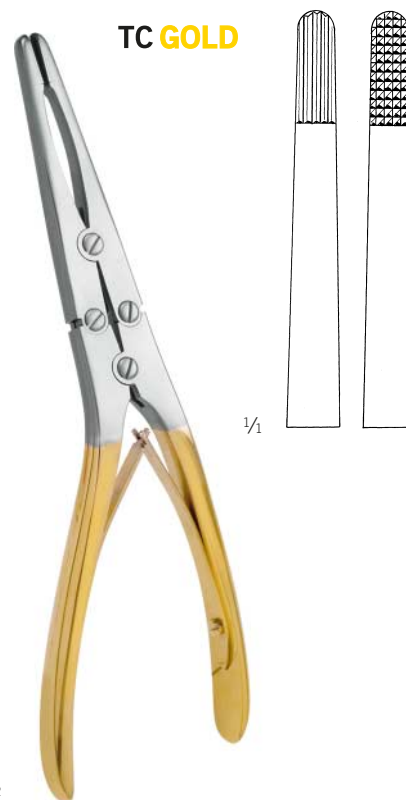


1/2

beide Schneiden gezahnt  
both cutting edges serrated  
ambos filos dentados  
deux lames dentées  
entrambe le lame dentate

1/2

Caplan  
37-331-20-07  
20 cm / 7 7/8"



**TC GOLD**

1/2

1/2

37-334-21-07  
20 cm / 7 7/8"

## Septumquetschzangen

Septum Morselizers  
Pinzas para aplastamiento  
Pincers-gouge pour la cloison nasale  
Pinze contundente per il setto nasale

## Rhinologie

Rhinology  
Rinología  
Rhinologie  
Rinologia



## TC GOLD



Rubin  
37-335-20-07  
20 cm / 7 7/8"



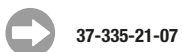
Rubin  
37-335-21-07  
18,5 cm / 7 2/8"



Rubin  
37-337-21-07  
18,5 cm / 7 2/8"



Rubin  
37-335-01-07  
Schutzkappe  
Protection Cap  
Caperuza protectora  
Capuchon protecteur  
Calotta protettiva



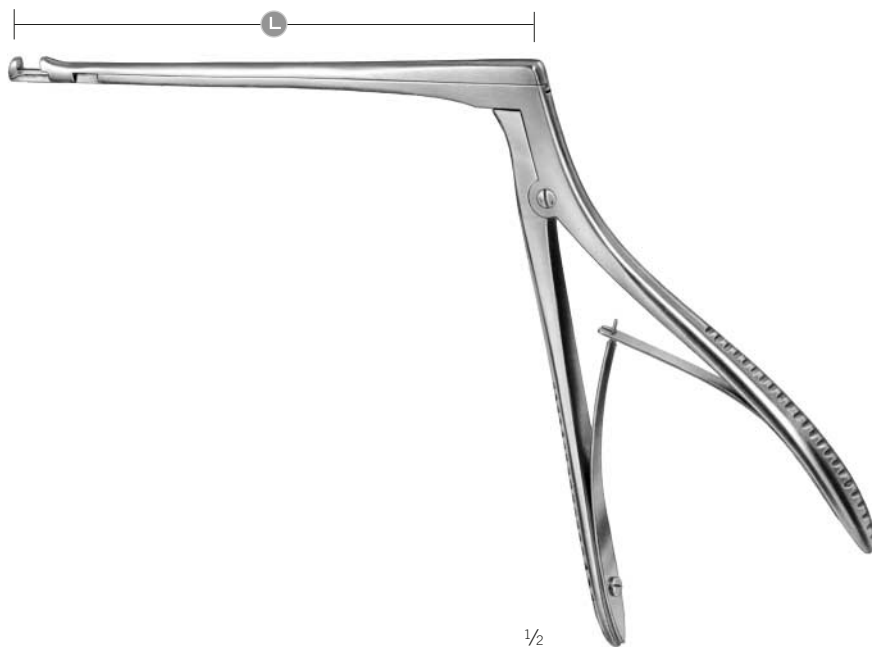
## Keilbeinstanzen

Sphenoid Bone Punches

Pinzas sacabocadas para esfenoides

Pinces emporte-pièces pour sinus sphénoïdal

Pinze taglienti per seno sfenoidale



Hajek  
37-340-13-07 -  
37-343-12-07

| Maulbreite<br>Jaw width<br>Anchura de la boca<br>Largeur de mors<br>Larghezza della bocca |          | 90°<br>aufwärts schneidend<br>cutting upward<br>corte arriba<br>tranchant vers le haut<br>tagliente verso l'alto | 90°<br>abwärts schneidend<br>cutting downward<br>desmontable, corte abajo<br>tranchant vers le bas<br>tagliente verso il basso |
|---|----------|--|--|
|   |          | $\frac{1}{1}$  |  |
|   | <b>L</b> | <b>14 cm</b>   | <b>14 cm</b>   |
| 3,5 mm  |          | 37-342-12-07   | 37-343-12-07   |
| 4 mm  |          | 37-340-13-07   | 37-341-13-07   |

## Keilbeinstanzen

Sphenoid Bone Punches

Pinzas sacabocadas para esfenoides

Pinces emporte-pièces pour sinus sphénoïdal

Pinze taglianti per seno sfenoidale

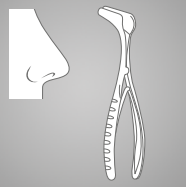
## Rhinologie

Rhinology

Rinología

Rhinologie

Rinologia



Ferris-Smith-Kerrison

37-356-17-07 -

37-362-05-07

37

| Maulbreite<br>Jaw width<br>Anchura de la boca<br>Largeur de mors<br>Larghezza della bocca |     | 90°<br>aufwärts schneidend<br>cutting upward<br>corte arriba<br>tranchant vers le haut<br>tagliante verso l'alto | 90°<br>abwärts schneidend<br>cutting downward<br>desmontable, corte abajo<br>tranchant vers le bas<br>tagliante verso il basso | 40°<br>abwärts schneidend<br>cutting downward<br>desmontable, corte abajo<br>tranchant vers le bas<br>tagliante verso il basso |
|---|-----|--|--|--|
|   | 1/1 |  |  |  |
|   | L   | 18 cm  | 18 cm  | 18 cm  |
| 3 mm  |     | 37-356-17-07   | 37-357-17-07   | 37-362-03-07   |
| 5 mm  |     | 37-360-17-07   | 37-361-17-07   | 37-362-05-07   |

## Antrumstanzen

Antrum Punches

Pinzas sacabocadas para seno maxilar

Pinces emporte-pièces pour sinus maxillaire

Pinze taglianti per seno mascellare



Kerrison  
37-389-00-07 -  
37-389-03-07

| <b>Maulbreite</b><br><b>Jaw width</b><br><b>Anchura de la boca</b><br><b>Largeur de mors</b><br><b>Larghezza della bocca</b> | <b>90°</b><br><b>aufwärts schneidend</b><br><b>cutting upward</b><br><b>corte arriba</b><br><b>tranchant vers le haut</b><br><b>tagliante verso l'alto</b> |
|--|--|
| <b>3 x 3 mm</b>  |  |
| <b>4 x 4 mm</b>  | <b>L 9 cm</b>  |
| <b>5 x 5 mm</b>  | <b>37-389-00-07</b>  |
| <b>6 x 6 mm</b>  | <b>37-389-01-07</b>  |
|  | <b>37-389-02-07</b>  |
|  | <b>37-389-03-07</b>  |

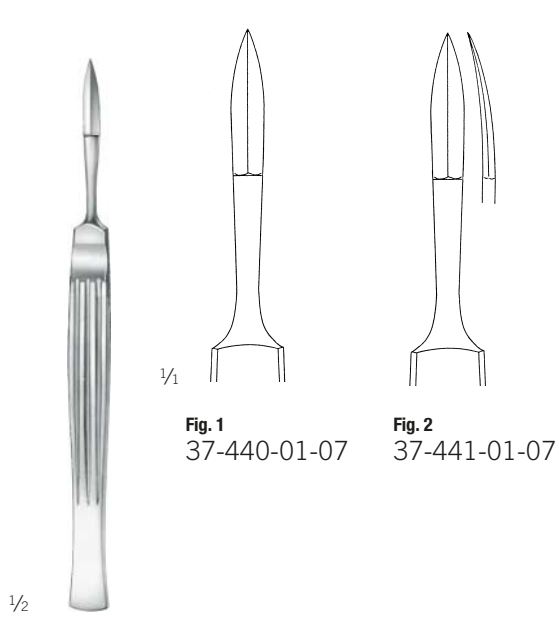
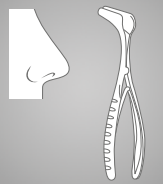


## Rhinoplastik-Messer

Rhinoplastic Knives  
Cuchillos rinoplásticos  
Couteaux pour plastie du nez  
Bisturi per plastica nasale

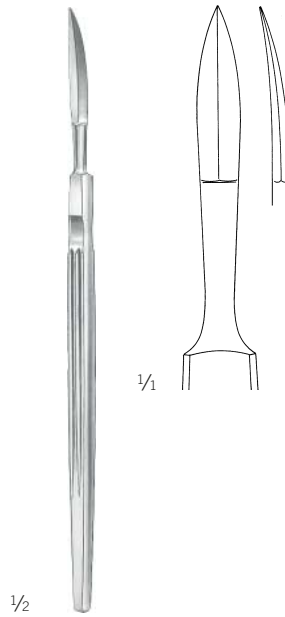
## Rhinologie

Rhinology  
Rinología  
Rhinologie  
Rinologia

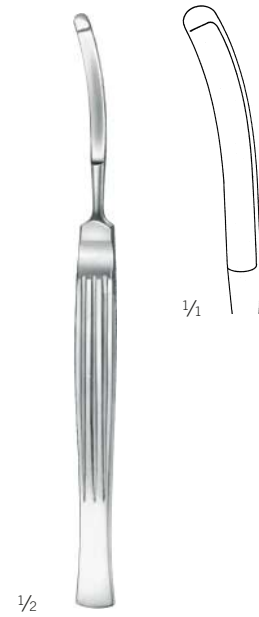


**Fig. 1**  
37-440-01-07

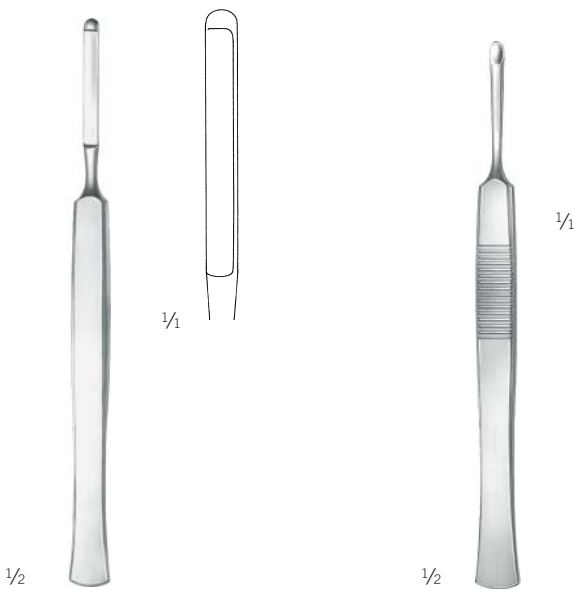
**Fig. 2**  
37-441-01-07



**Fomon**  
37-444-16-07  
16,5 cm / 6 4/8"



**Converse**  
37-459-16-07  
16 cm / 6 2/8"



**Joseph**  
37-466-15-07  
15,5 cm / 6 1/8"

**Cottle**  
37-468-15-07  
14 cm / 5 4/8"

## Septummesser, Schwingmesser

Septum Knives, Swivel Knives

Cuchillos para tabique nasal

Bistouris pour la cloison nasale

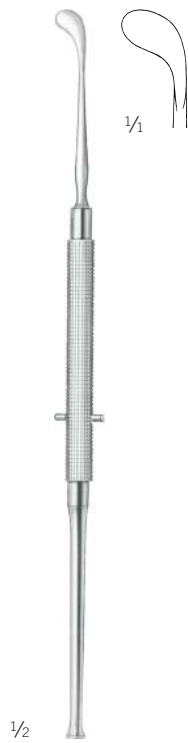
Bisturi per il setto nasale



Freer  
37-484-15-07

15,5 cm / 6 1/8"

Mukosamesser  
Mucosa Knife  
Cuchillo para mucosa  
Couteau pour muqueuse  
Bisturi per mucosa



Freer  
37-497-19-07

19 cm / 7 4/8"

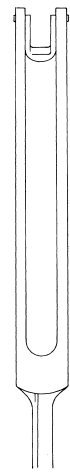


Freer  
37-499-19-07

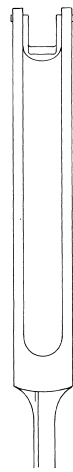
18,5 cm / 7 3/8"



**3 mm**  
37-504-03-07

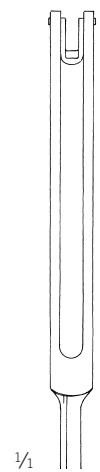


**4 mm**  
37-504-04-07



**5 mm**  
37-504-05-07

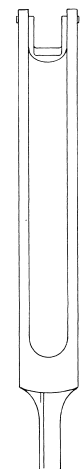
Ballenger  
37-504-03-07 -  
37-504-05-07  
21 cm / 8 2/8"



**3 mm**  
37-505-03-07



**4 mm**  
37-505-04-07



**5 mm**  
37-505-05-07

Ballenger  
37-505-03-07 -  
37-505-05-07  
20,5 cm / 8 1/8"

## Septumelevatorien

Septum Elevators

Elevadores para tabique nasal

Élévateurs pour la cloison nasale

Elevatori per il setto nasale

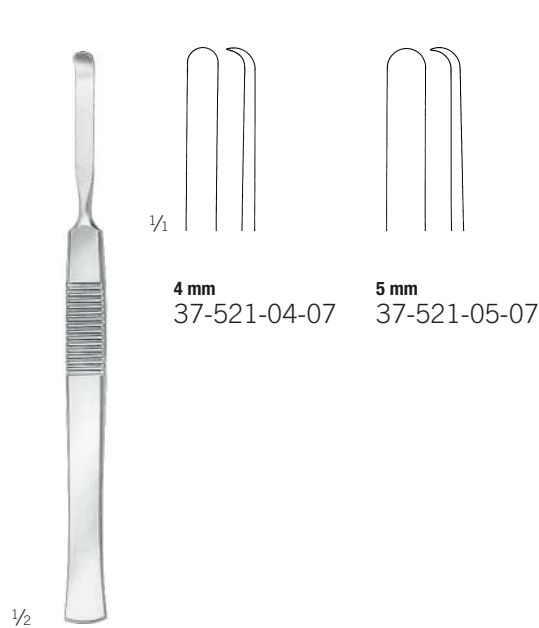
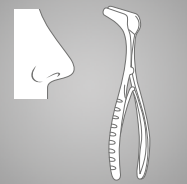
## Rhinologie

Rhinology

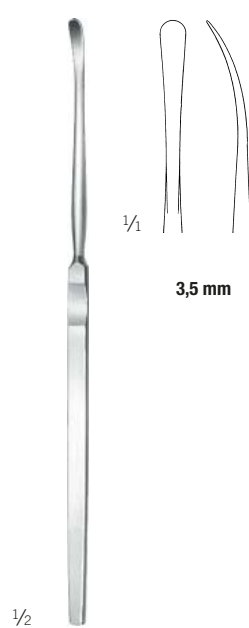
Rinología

Rhinologie

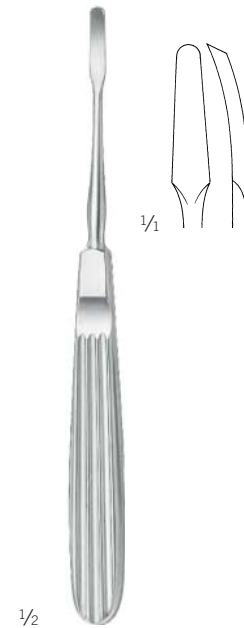
Rinologia



McKenty  
37-521-04-07 -  
37-521-05-07  
15 cm / 5 7/8"



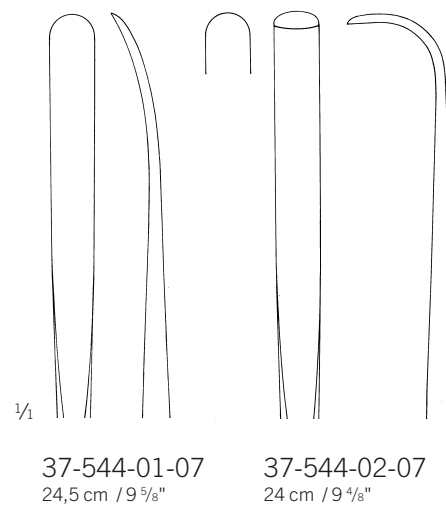
Halle  
37-525-16-07  
16 cm / 6 1/8"



Joseph  
37-531-16-07  
16,5 cm / 6 1/2"

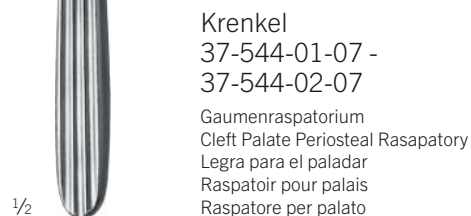


Freer  
37-541-19-07 -  
37-543-19-07  
19 cm / 7 1/2"



37-544-01-07  
24,5 cm / 9 5/8"

37-544-02-07  
24 cm / 9 1/2"



Krenkel  
37-544-01-07 -  
37-544-02-07  
Gaumenraspatorium  
Cleft Palate Periosteal Raspatory  
Legra para el paladar  
Raspatoir pour palais  
Raspatore per palato

37

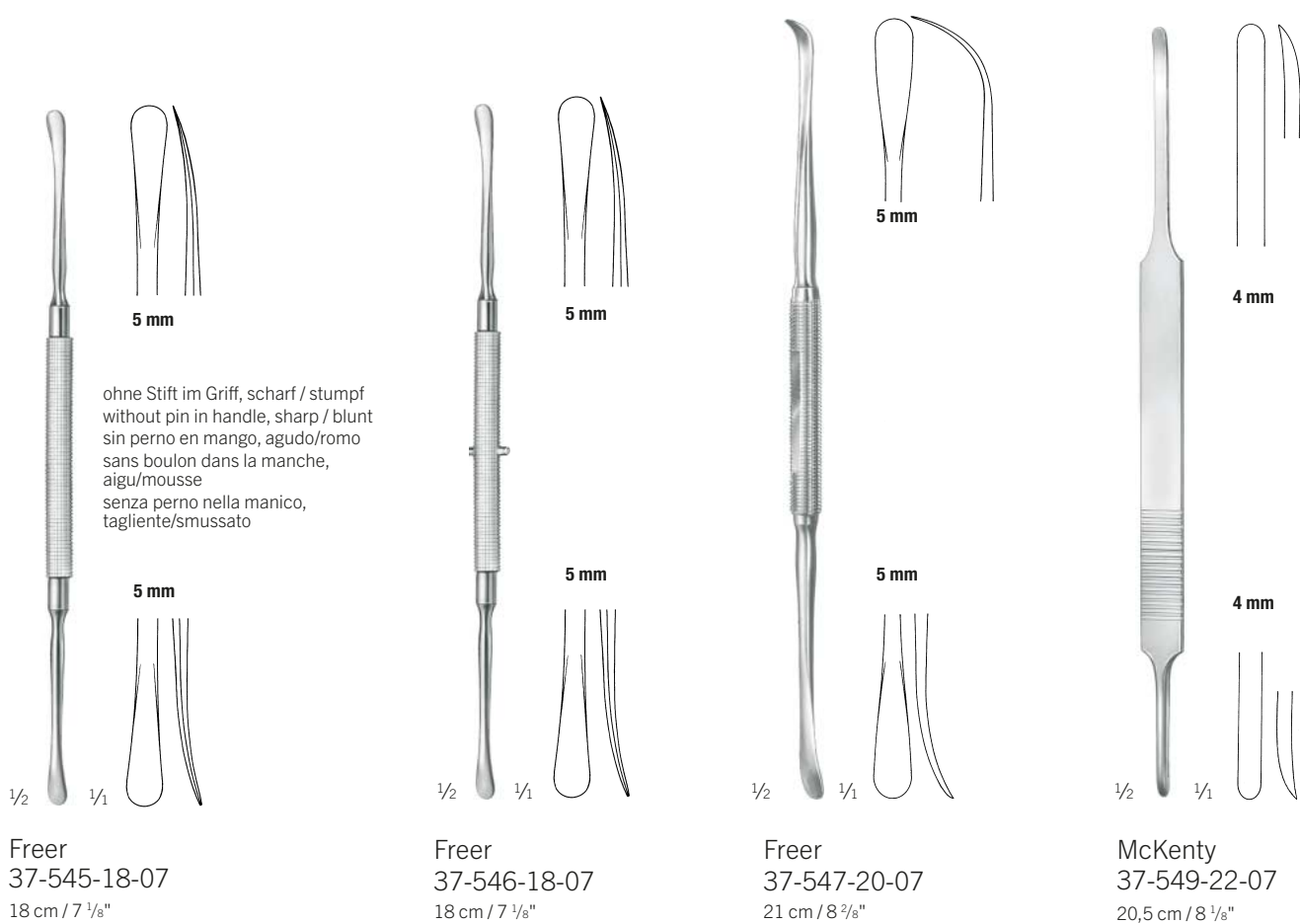
## Septumelevatorien

Septum Elevators

Elevadores para tabique nasal

Élévateurs pour la cloison nasale

Elevatori per il setto nasale



## Septumlevatorien

Septum Elevators

Elevadores para tabique nasal

Elévateurs pour la cloison nasale

Elevatori per il setto nasale

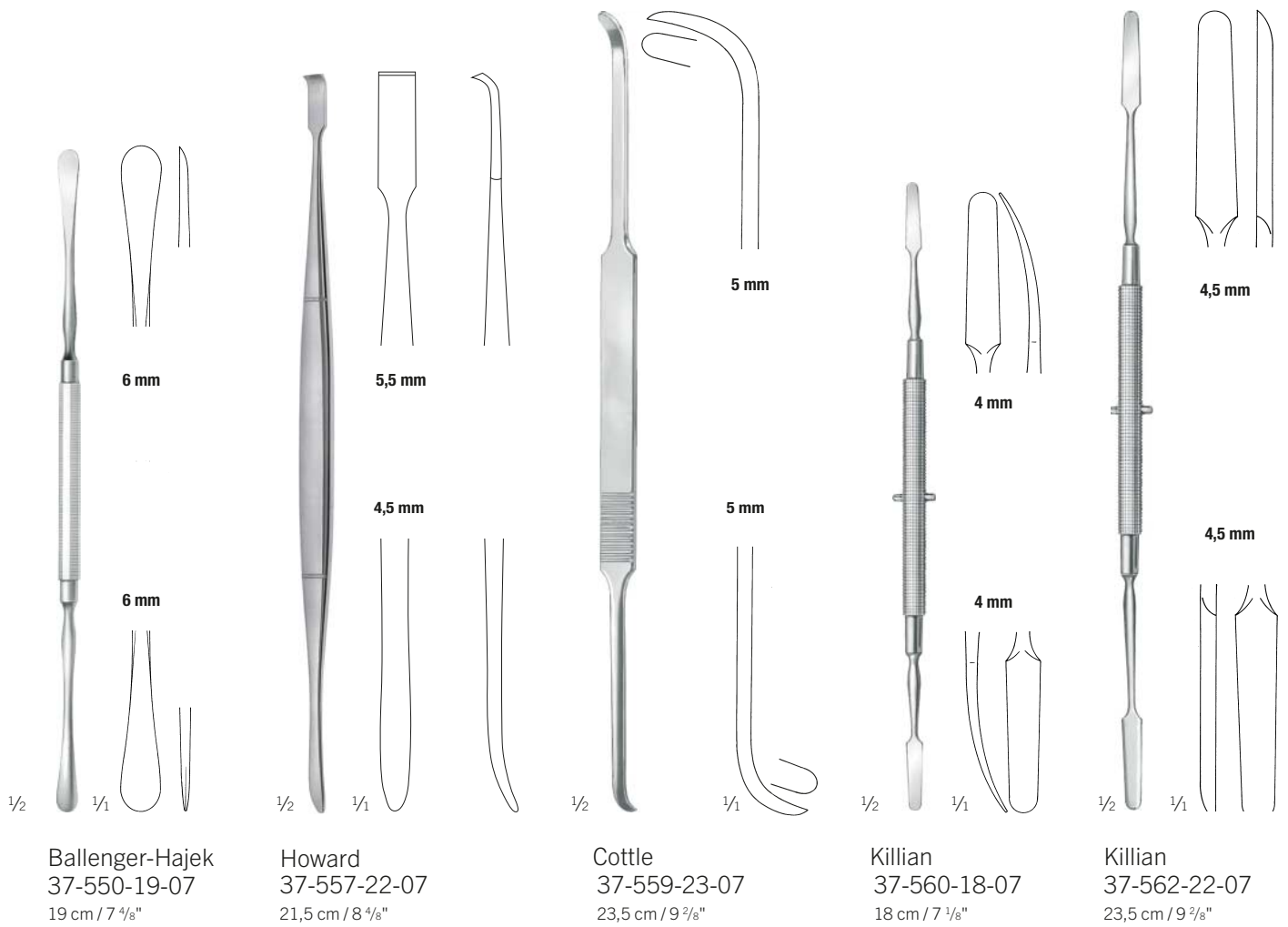
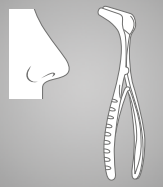
## Rhinologie

Rhinology

Rinología

Rhinologie

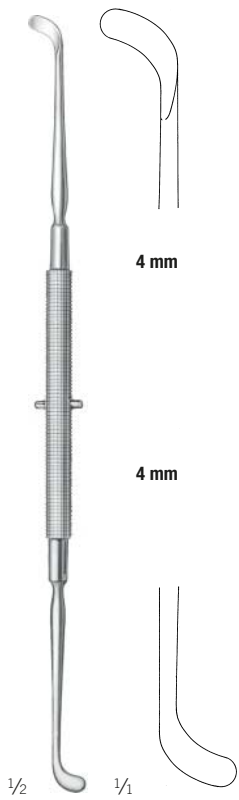
Rinologia



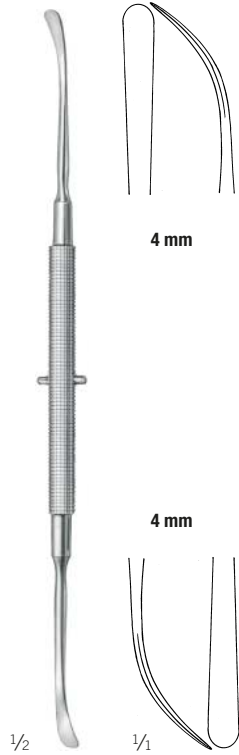
37

# Periostelevatorien

Periosteal Elevators  
 Legras para periostio  
 Elévateurs pour le périoste  
 Elevatori per il periostio



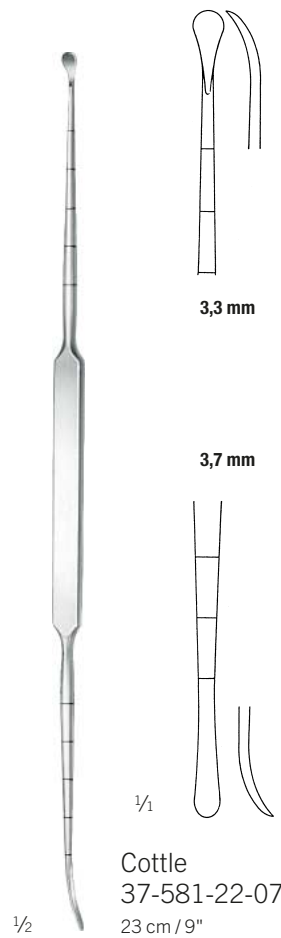
Pennington  
 37-568-21-07  
 21,5 cm / 8 4/8"



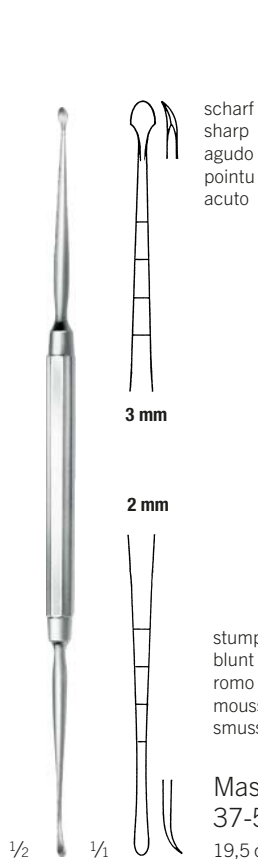
Roger  
 37-572-19-07  
 20 cm / 7 7/8"



Joseph-Masing  
 37-579-22-07  
 21,5 cm / 8 4/8"



Cottle  
 37-581-22-07  
 23 cm / 9"



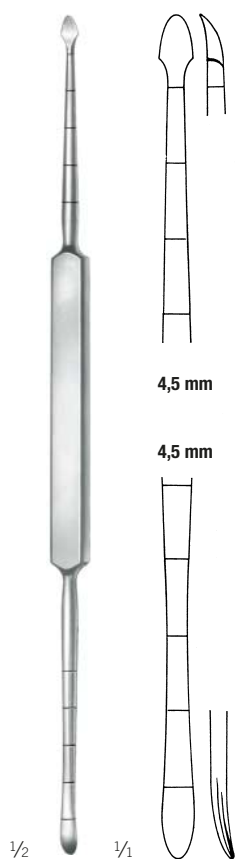
scharf  
 sharp  
 agudo  
 pointu  
 acuto

3 mm

2 mm

stumpf  
 blunt  
 romo  
 mousse  
 smusso

Masing  
 37-583-21-07  
 19,5 cm / 7 5/8"



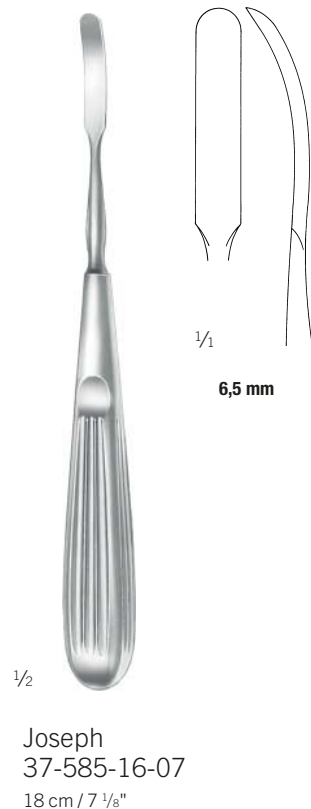
scharf  
 sharp  
 agudo  
 pointu  
 acuto

4,5 mm

4,5 mm

stumpf  
 blunt  
 romo  
 mousse  
 smusso

Cottle  
 37-584-21-07  
 22 cm / 8 5/8"



1/1

6,5 mm

1/2

Joseph  
 37-585-16-07  
 18 cm / 7 1/8"

## Septummeißel, Septum-Hohlmeißel

Septum Chisels, Septum Gouges

Cinceles para tabique nasal, Gubias para tabique nasal

Élévateurs pour le périoste, Gouges pour la cloison nasale

Elevatori per il periosto, Sgorbie per il setto nasale

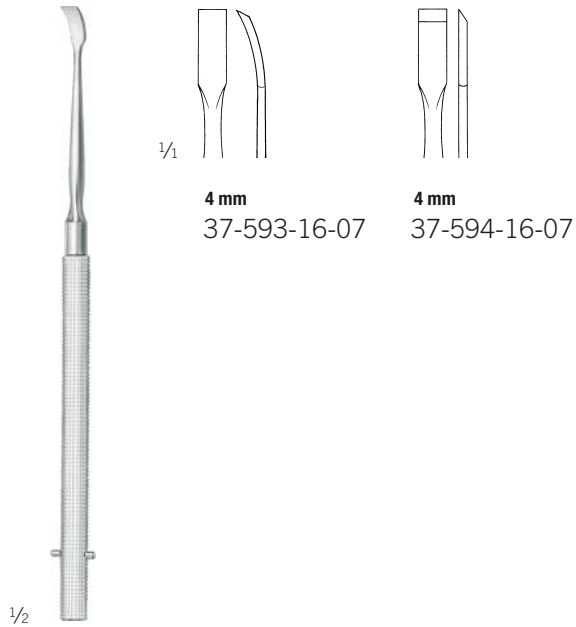
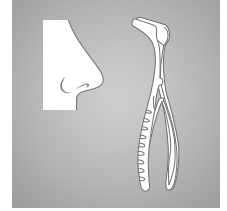
## Rhinologie

Rhinology

Rinología

Rhinologie

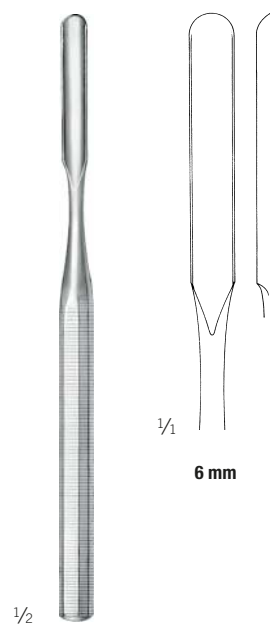
Rinologia



**4 mm**  
37-593-16-07

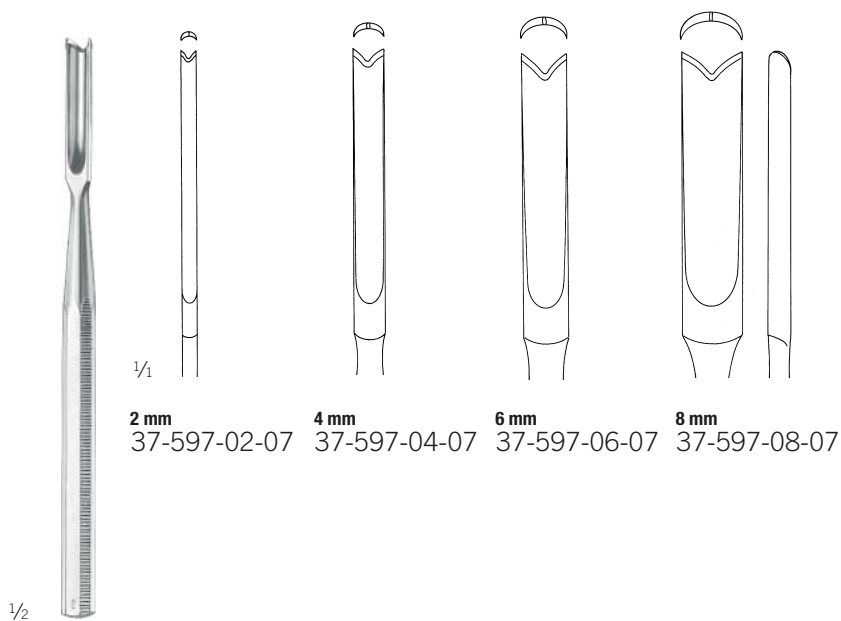
**4 mm**  
37-594-16-07

Freer  
37-593-16-07 -  
37-594-16-07  
16,5 cm / 6 4/8"



**6 mm**

Freer  
37-595-15-07  
16 cm / 6 2/8"



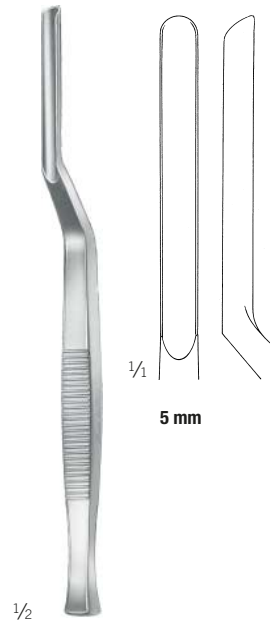
**2 mm**  
37-597-02-07

**4 mm**  
37-597-04-07

**6 mm**  
37-597-06-07

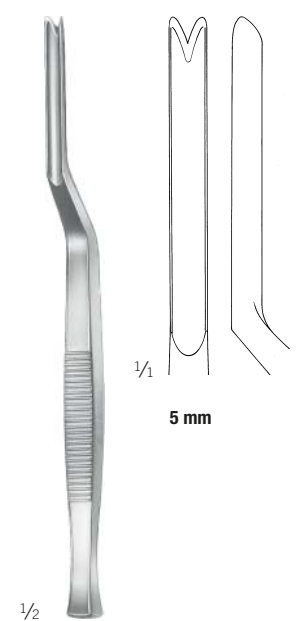
**8 mm**  
37-597-08-07

Ballenger  
37-597-02-07 -  
37-597-08-07  
15 cm / 5 7/8"



**5 mm**

Killian  
37-601-16-07  
16 cm / 6 2/8"



**5 mm**

Killian-Claus  
37-605-16-07  
16 cm / 6 2/8"

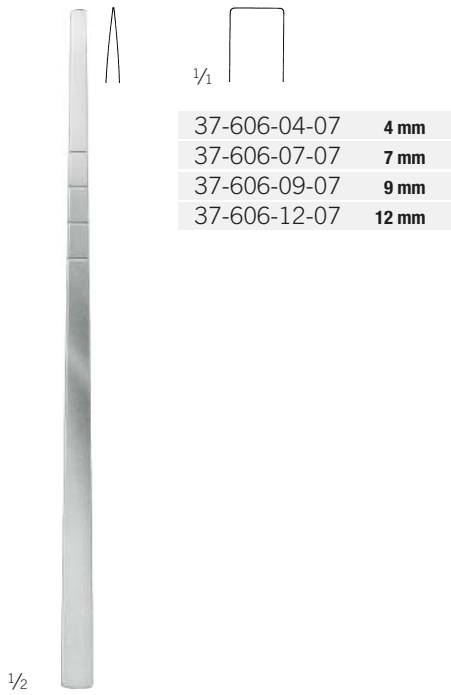
# Osteotome

Osteotomes

Osteótomos

Ostéotomes

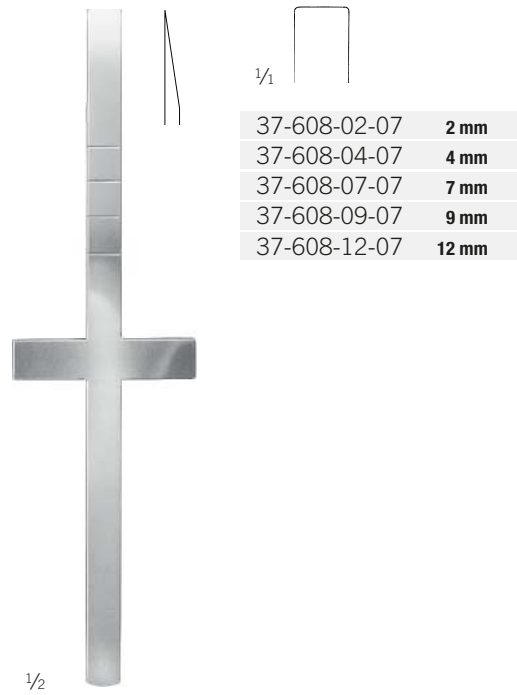
Osteotomi



Cottle  
37-606-04-07 -  
37-606-12-07  
18,5 cm / 7 2/8"



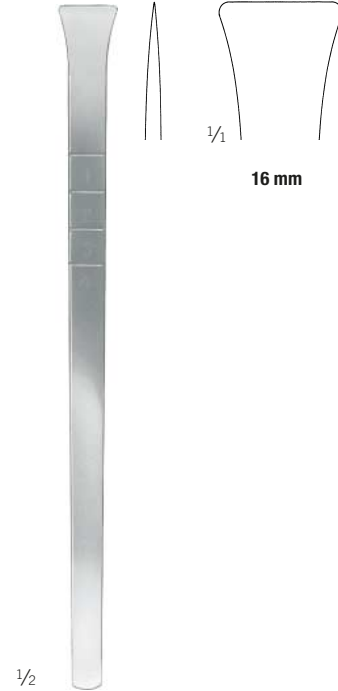
Cottle  
37-607-06-07  
18,5 cm / 7 2/8"



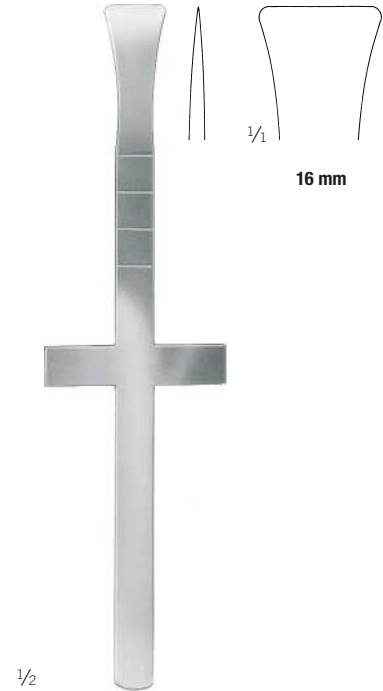
Cottle  
37-608-02-07 -  
37-608-12-07  
18,5 cm / 7 2/8"



Cottle  
37-609-06-07  
18,5 cm / 7 2/8"



Cottle  
37-610-16-07  
18,5 cm / 7 2/8"



Cottle  
37-612-16-07  
18,5 cm / 7 2/8"

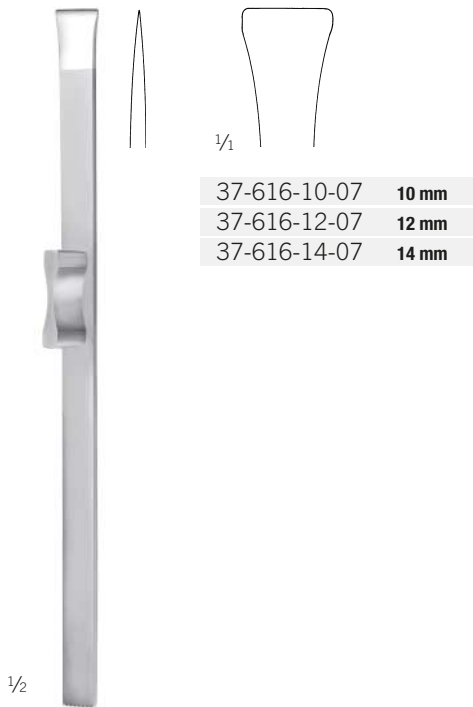
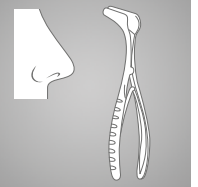


## Osteotome, Meißel

Osteotomes, Chisels  
 Osteótomos, Cinceles  
 Ostéotomes, Ciseaux-burins  
 Osteotomi, Scalpelli

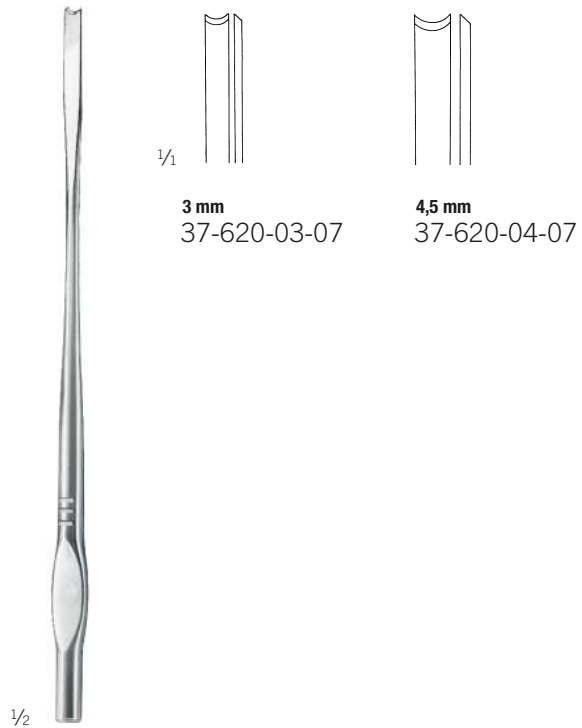
## Rhinologie

Rhinology  
 Rinología  
 Rinologie  
 Rinologia



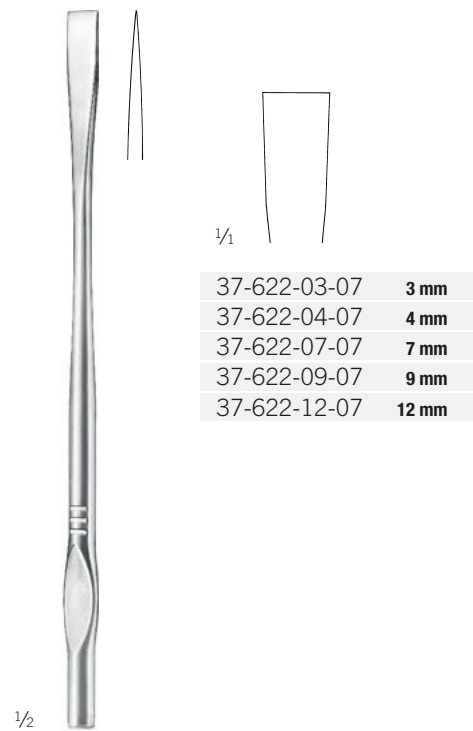
|              |              |
|--------------|--------------|
| 37-616-10-07 | <b>10 mm</b> |
| 37-616-12-07 | <b>12 mm</b> |
| 37-616-14-07 | <b>14 mm</b> |

Rubin  
 37-616-10-07 -  
 37-616-14-07  
 18,5 cm / 7 7/8"



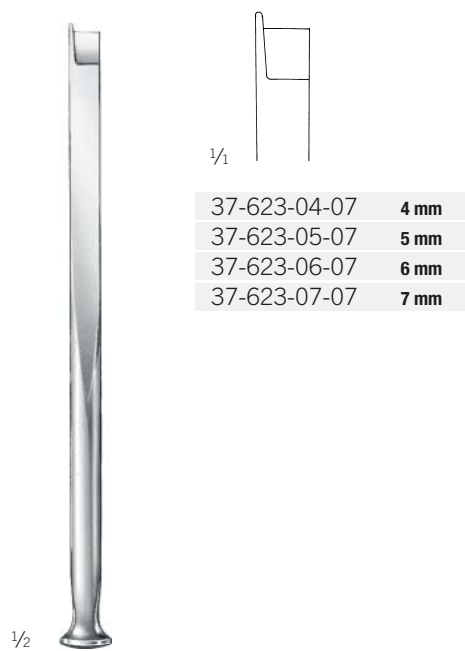
|              |             |              |               |
|--------------|-------------|--------------|---------------|
| 37-620-03-07 | <b>3 mm</b> | 37-620-04-07 | <b>4,5 mm</b> |
|--------------|-------------|--------------|---------------|

Walter  
 37-620-03-07 -  
 37-620-04-07  
 19 cm / 7 7/8"



|              |              |
|--------------|--------------|
| 37-622-03-07 | <b>3 mm</b>  |
| 37-622-04-07 | <b>4 mm</b>  |
| 37-622-07-07 | <b>7 mm</b>  |
| 37-622-09-07 | <b>9 mm</b>  |
| 37-622-12-07 | <b>12 mm</b> |

Walter  
 37-622-03-07 -  
 37-622-12-07  
 19 cm / 7 7/8"



|              |             |
|--------------|-------------|
| 37-623-04-07 | <b>4 mm</b> |
| 37-623-05-07 | <b>5 mm</b> |
| 37-623-06-07 | <b>6 mm</b> |
| 37-623-07-07 | <b>7 mm</b> |

Fomon  
 37-623-04-07 -  
 37-623-07-07  
 16 cm / 6 7/8"

37

## Nasenmeißel, Meißel

Rhinoplastic Chisels, Chisels

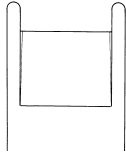
Cinceles nasales, Cinceles

Ciseaux-burins nasaux, Ciseaux-burins

Scalpelli nasali, Scalpelli



1/1



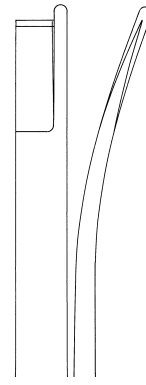
|              |       |
|--------------|-------|
| 37-624-10-07 | 10 mm |
| 37-624-12-07 | 12 mm |
| 37-624-14-07 | 14 mm |
| 37-624-16-07 | 16 mm |

1/2

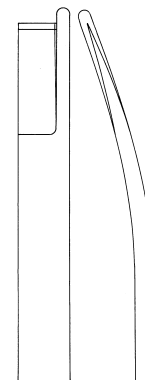
Cinelli  
37-624-10-07 -  
37-624-16-07  
16 cm / 6 1/8"



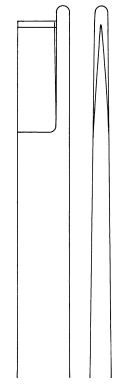
1/1



7 mm  
37-625-01-07



7 mm  
37-625-02-07



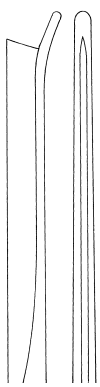
7 mm  
37-625-03-07

1/2

Neivert-Anderson  
37-625-01-07 -  
37-625-03-07  
20,5 cm / 8 1/8"



1/1



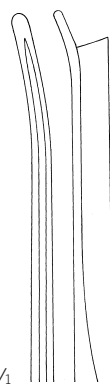
5 mm

1/2

Silver  
37-628-01-07  
18 cm / 7 1/8"



1/1



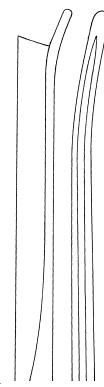
5 mm

1/2

Silver  
37-628-02-07  
18 cm / 7 1/8"



1/1



5 mm

1/2

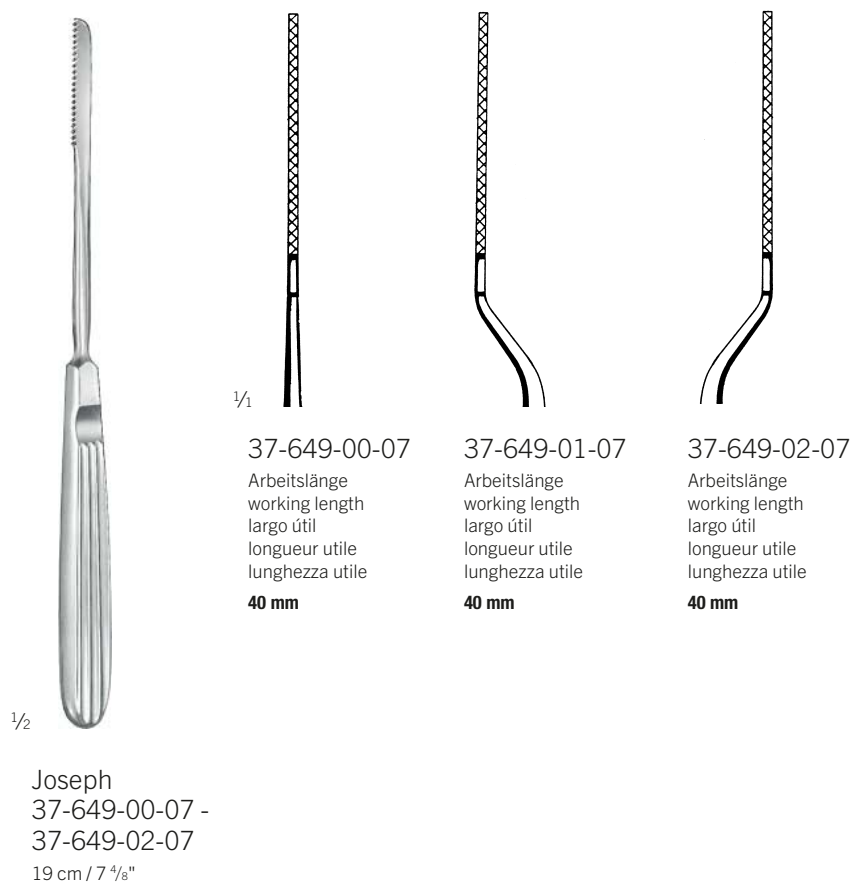
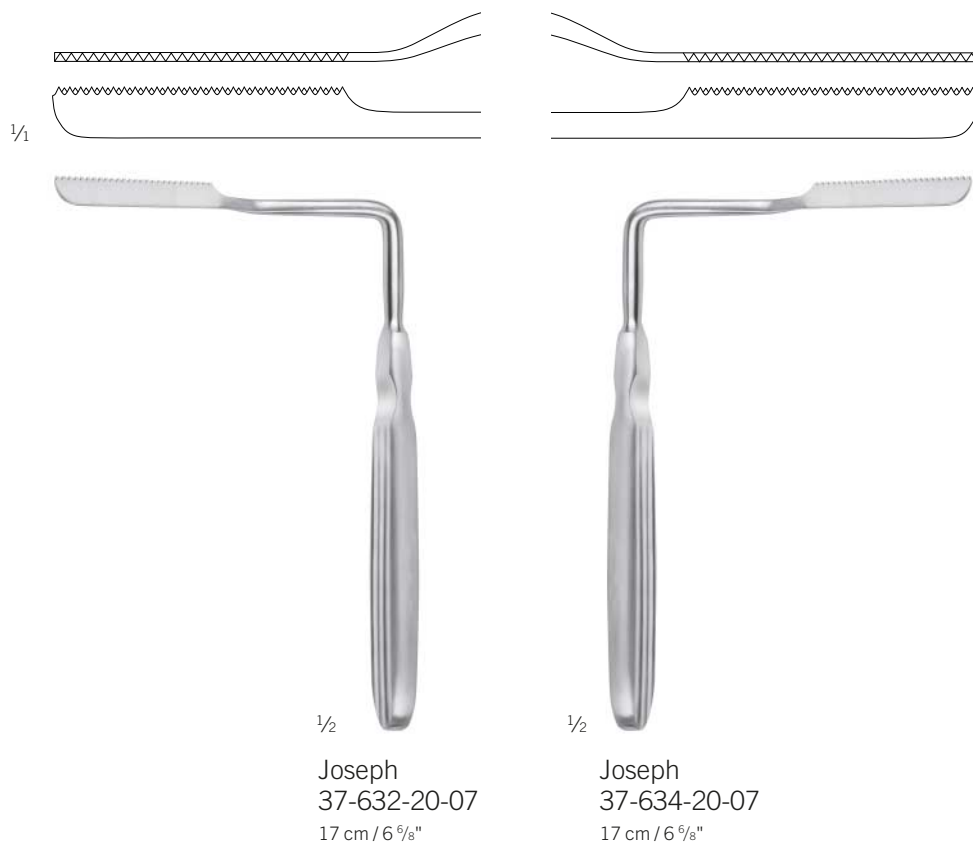
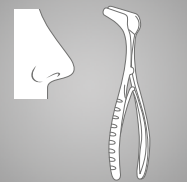
Silver  
37-628-03-07  
18 cm / 7 1/8"

## Nasensägen

Nasal Saws  
Sierras nasales  
Scies nasales  
Seghe nasali

## Rhinologie

Rhinology  
Rinología  
Rhinologie  
Rinologia



## Knorpelquetsche

Cartilage Crusher

Machacadora

Pinces-gouge à cartilage

Torchio per cartilagine



1/2

Cottle  
37-652-00-07

Knorpelquetsche  
Cartilage Crusher  
Machacadora  
Pinces-gouge à cartilage  
Torchio per cartilagine

**65 x 30 x 30 mm**

## Nasenraspeln, Knochenfeilen, Antrumraspeln

Nasal Rasps, Bone Files, Antrum Rasps

Escofinas nasales, Limas para huesos, Escofinas para el antro

Râpes nasales, Limes à os, Râpes pour antre

Raspe nasali, Lime per ossa, Raspe per seno mascellare

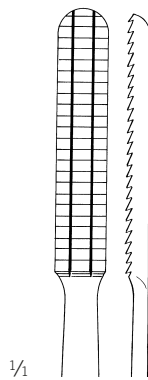
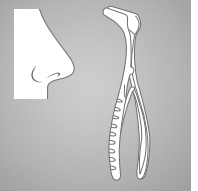
## Rhinologie

Rhinology

Rinología

Rhinologie

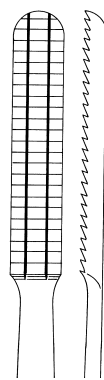
Rinologia



37-656-01-07

auf Zug schneidend  
drawing cut  
cortante a tracción  
tranchante à traction  
tagliente a trazione

34 x 7 mm



37-656-02-07

auf Stoss schneidend  
pushing cut  
cortante a empuje  
tranchante à impact  
tagliente a urto

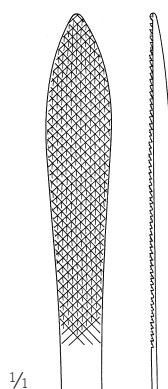
34 x 7 mm

1/2

Maltz  
37-656-01-07 -  
37-656-02-07

17 cm / 6 5/8"

37

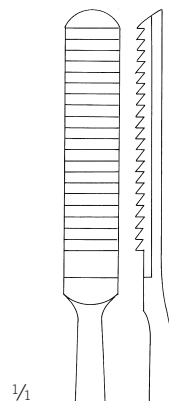


60 x 8 mm

1/2

Joseph  
37-658-01-07

16 cm / 6 2/8"



auf Zug schneidend  
drawing cut  
cortante a tracción  
tranchante à traction  
tagliente a trazione

34 x 8 mm

1/2

Cottle  
37-670-21-07

21 cm / 8 2/8"

## Glabellaraspeln, Nasenraspeln

Glabella Rasps, Nasal Rasps

Escofinas para glabella, Escofinas nasales

Râpes pour la glabelle, Râpes nasales

Raspe per glabella, Raspe nasali



1/1

**32 x 9 mm**

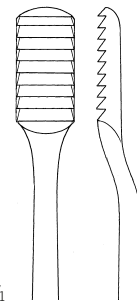
37-671-21-07

auf Stoss schneidend  
pushing cut  
cortante a empuje  
tranchante à impact  
tagliente a urto

**32 x 9 mm**

37-673-21-07

auf Zug schneidend  
drawing cut  
cortante a tracción  
tranchante à traction  
tagliente a trazione

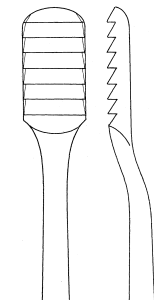


1/1

**15 x 8 mm**

37-674-18-07

auf Zug schneidend  
drawing cut  
cortante a tracción  
tranchante à traction  
tagliente a trazione



**15 x 8 mm**

37-676-18-07

auf Zug schneidend  
drawing cut  
cortante a tracción  
tranchante à traction  
tagliente a trazione

feine Zahnung  
delicate serration  
dentado fina  
denture fine  
dentatura delicata

grobe Zahnung  
coarse serration  
dentado grueso  
denture grossière  
dentatura grossolana



1/2

Lewis

37-674-18-07 -

37-676-18-07

19 cm / 7 1/8"

1/2

Aufricht

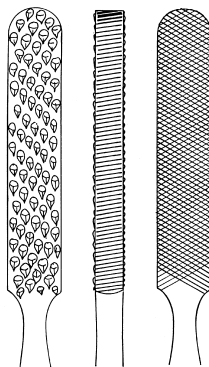
37-671-21-07 -

37-673-21-07

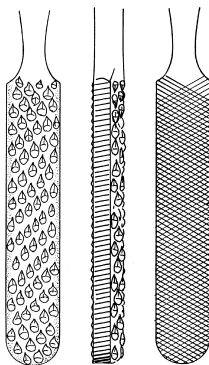
21 cm / 8 3/8"



1/2



1/1



**7 mm**

Fomon

37-680-21-07

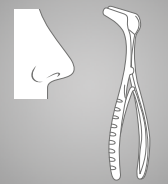
20,5 cm / 8 1/8"

# Nasenraspeln

Nasal Rasps  
Escofinas nasales  
Râpes nasales  
Raspe nasali

# Rhinologie

Rhinology  
Rinología  
Rhinologie  
Rinologia



## TC GOLD

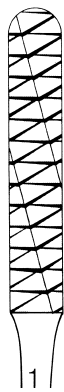


Fig. 1  
37-680-01-07



Fig. 2  
37-680-02-07



Fig. 3  
37-680-03-07



Fig. 4  
37-680-04-07



Fig. 5  
37-680-05-07

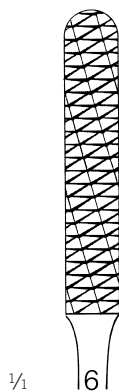


Fig. 6  
37-680-06-07



Fig. 7  
37-680-07-07



Fig. 8  
37-680-08-07



Fig. 9  
37-680-09-07



Fig. 10  
37-680-10-07

37

7 mm  
Maltz  
37-680-01-07 -  
37-680-10-07  
21 cm / 8 2/8"

# Nasenraspeln

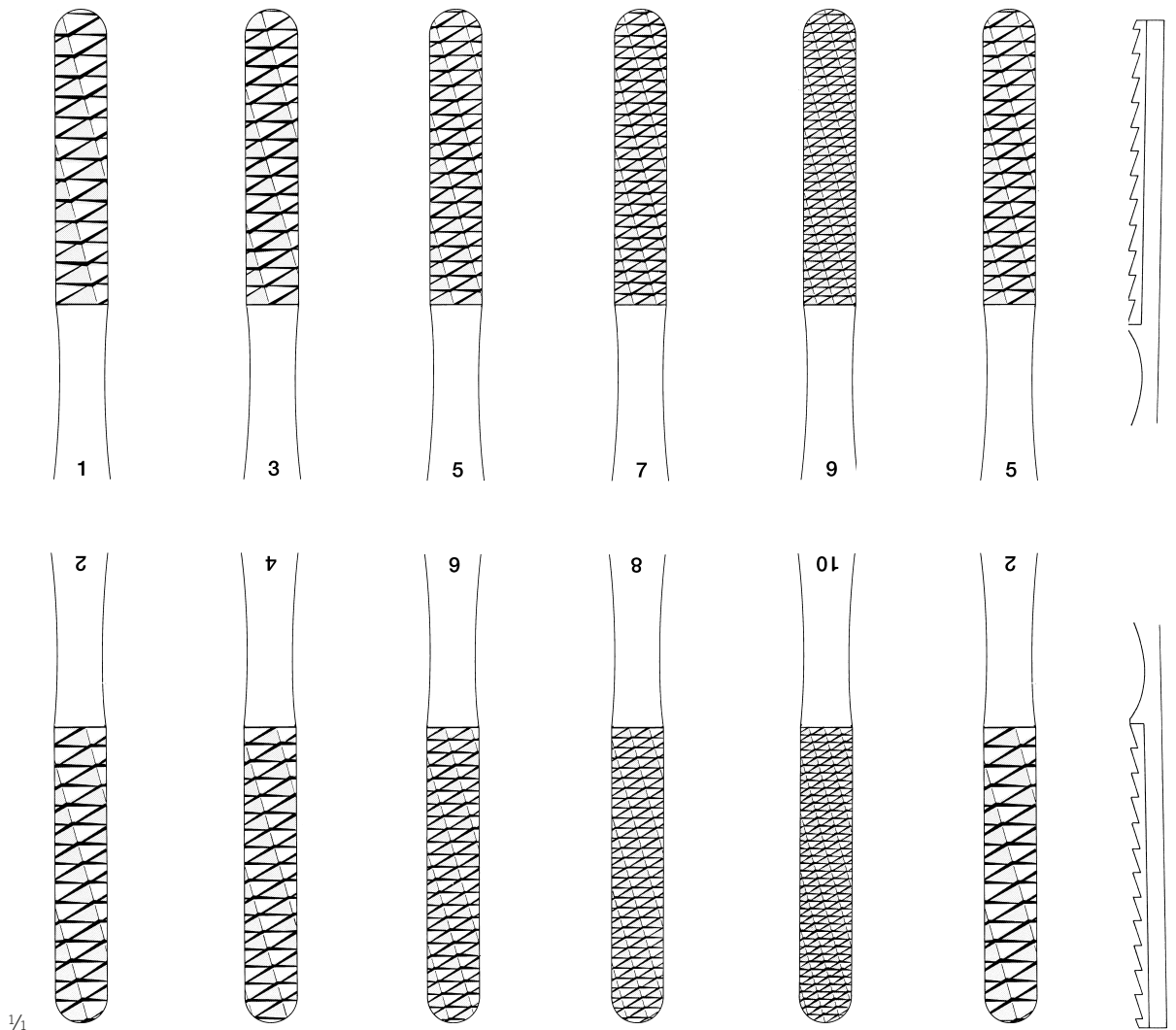
Nasal Rasps

Escofinas nasales

Râpes nasales

Raspe nasali

## TC GOLD



**Fig. 1/2**  
37-682-01-07  
40 x 7 mm

**Fig. 3/4**  
37-682-02-07  
40 x 7 mm

**Fig. 5/6**  
37-682-03-07  
40 x 7 mm

**Fig. 7/8**  
37-682-04-07  
40 x 7 mm

**Fig. 9/10**  
37-682-05-07  
40 x 7 mm

**Fig. 2/5**  
37-682-06-07  
40 x 7 mm

Fomon  
37-682-01-07 -  
37-682-06-07  
20,5 cm / 8 1/8"

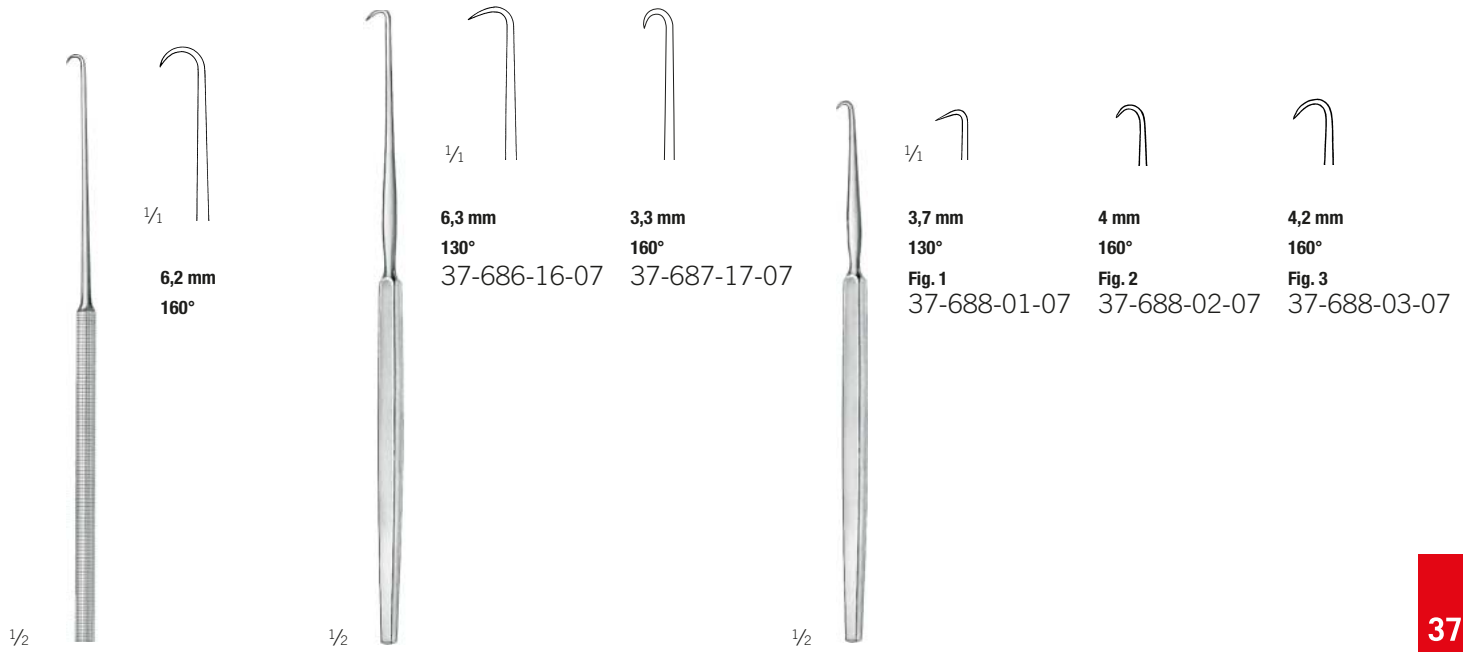
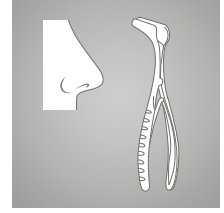


# Nasenhäkchen

Nasal Hooklets  
Ganchitos nasales  
Crochets nasaux  
Uncini nasali

# Rhinologie

Rhinology  
Rinología  
Rhinologie  
Rinologia



**Joseph**  
37-684-15-07  
15,5 cm / 6 1/8"  
Schleimhauthäkchen, scharf  
Mucosa Hooklet, sharp  
Ganchito para mucosa, agudo  
Crochet pour la muqueuse, pointu  
Uncino per mucosa, acuto

**Cottle**  
37-686-16-07 - 37-687-17-07  
17 cm / 6 1/8"  
scharf  
sharp  
agudo  
pointu  
acuto

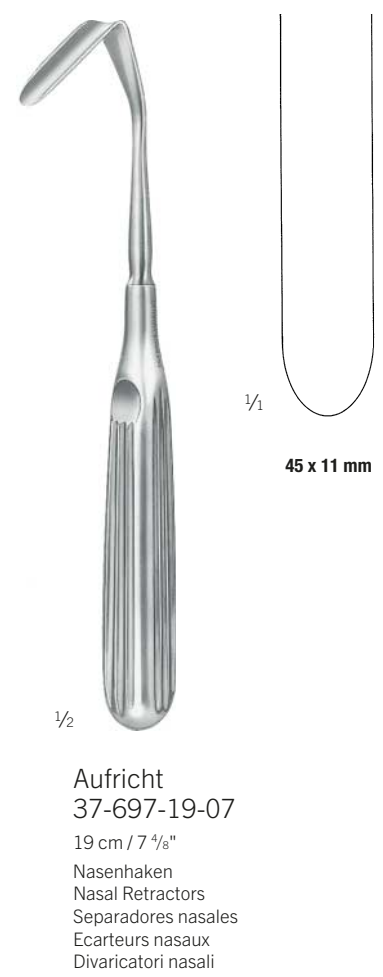
**Cottle**  
37-688-01-07 - 37-688-03-07  
14,5 cm / 5 9/16"  
scharf  
sharp  
agudo  
pointu  
acuto



**Lange**  
37-692-22-07  
23 cm / 9"  
Nasenflügelhäkchen, Knopfende  
Alar Hooklet, button end  
Ganchito para alas de nariz, botonado  
Crochet pour les ailes du nez, boutonné  
Uncino per le pinne nasali, con fine a bottone



**Fomon**  
37-694-17-07  
17 cm / 6 6/8"  
Nasenflügelhäkchen, Knopfende  
Alar Hooklet, button end  
Ganchito para alas de nariz, botonado  
Crochet pour les ailes du nez, boutonné  
Uncino per le pinne nasali, con fine a bottone



**Aufrecht**  
37-697-19-07  
19 cm / 7 4/8"  
Nasenhaken  
Nasal Retractors  
Separadores nasaux  
Ecarteurs nasaux  
Divaricatori nasali

37

## Nasenflügelhäkchen, Schleimhauthäkchen

Alar Hooklets, Mucosa Hooklet

Ganchitos para alas de nariz, Ganchito para mucosa

Crochets pour les ailes du nez, Crochet pour la muqueuse

Uncini per le pinne nasali, Uncino per mucosa



1/2

**Kilner**  
37-698-10-07

8 cm / 3 1/8"

scharf  
sharp  
agudo  
pointu  
acuto

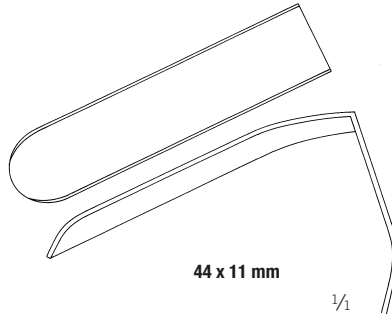


1/2

**Converse**  
37-699-11-07

10,5 cm / 4 1/8"

Nasenhaken  
Nasal Retractors  
Separadores nasales  
Ecarteurs nasaux  
Divaricatori nasali



44 x 11 mm

1/4



1/2

**Converse**  
37-700-12-07

11,5 cm / 4 5/8"

scharf  
sharp  
agudo  
pointu  
acuto



1/2

**Freer**  
37-702-15-07

15 cm / 5 7/8"

scharf  
sharp  
agudo  
pointu  
acuto



1/2

**Joseph**  
37-704-02-07 -  
37-704-10-07

16 cm / 6 1/8"



1/4

**2 mm**  
37-704-02-07



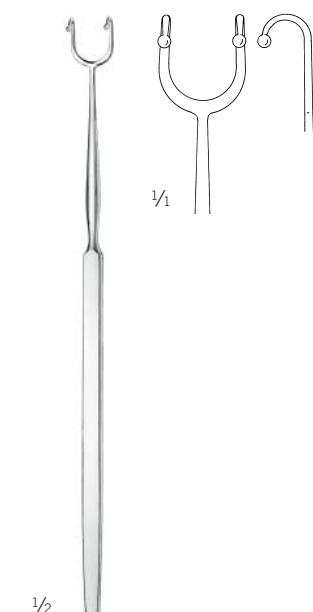
**5 mm**  
37-704-05-07



**7 mm**  
37-704-07-07



**10 mm**  
37-704-10-07



1/2

**Fomon**  
37-706-16-07

16 cm / 6 2/8"

geknöpft  
button ended  
abotonado  
boutonné  
a bottone

## Nasenflügelhäkchen, Nasenhaken

Alar Hooklets, Nasal Retractors

Ganchitos para alas de nariz, Separadores nasales

Crochets pour les ailes du nez, Ecarteurs nasaux

Uncini per le pinne nasali, Divaricatori nasali

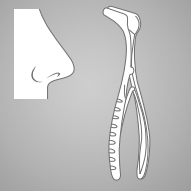
## Rhinologie

Rhinology

Rinología

Rhinologie

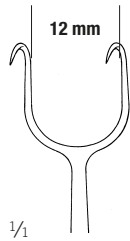
Rinologia



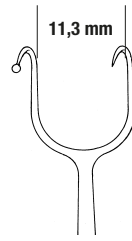
Cottle-Neivert  
37-707-20-07  
19,5 cm / 7 5/8"



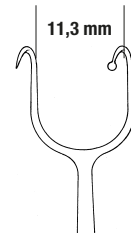
Cottle  
37-708-14-07 -  
37-709-02-07  
14,5 cm / 5 9/8"



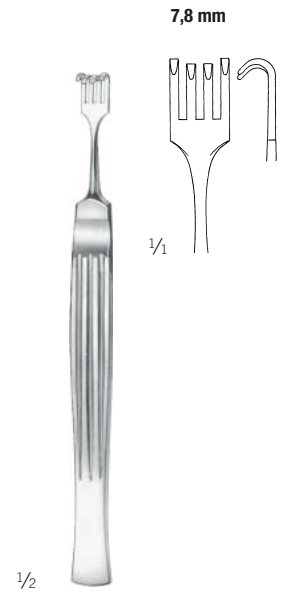
37-708-14-07  
scharf  
sharp  
agudo  
pointu  
acuto



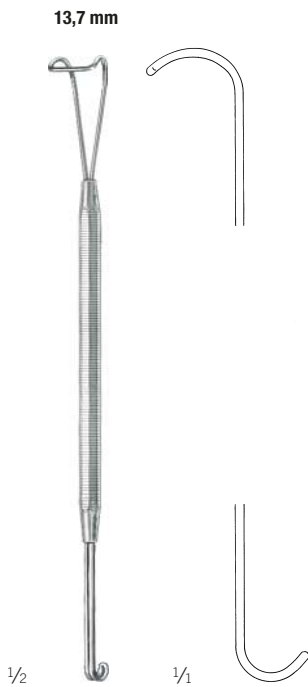
37-709-01-07  
stumpf/scharf  
blunt/sharp  
romo/agudo  
mousse/aiguë  
smusso/acuto



37-709-02-07  
scharf/stumpf  
sharp/blunt  
agudo/romo  
aiguë/mousse  
acuto/smusse



Cottle  
37-710-14-07  
14 cm / 5 4/8"



Neivert  
37-712-16-07  
17 cm / 6 6/8"



Cottle  
37-713-15-07  
14 cm / 5 4/8"  
Sattelhäkchen  
Saddle Hook  
Separador en forma de silla  
Élévateur sous forme de selle  
Elevatori in forma di sella



Cottle  
37-714-15-07  
16 cm / 6 3/8"



Aufricht  
37-715-14-07  
12 cm / 4 6/8"  
stumpf  
blunt  
romo  
mousse  
smusso

Blätter  
blades  
hojas  
lames  
lame  
60 x 6,5 mm

## Septumzangen, Septumrichtzangen

Septum Forceps, Septum Straightening Forceps

Pinzas para tabique nasal, Pinzas para enderezar el tabique nasal

Pinces pour la cloison nasale, Pinces pour le redressement de la cloison nasale

Pinze per il setto nasale, Pinze per raddizzare il setto nasale



37-724-01-07

gerade  
straight  
recta  
droite  
diritta

37-724-02-07

links  
left  
izquierdo  
gauche  
sinistra

37-724-03-07

rechts  
right  
derecho  
droit  
destra



1/2

Kressner  
37-721-20-07  
22 cm / 8 5/8"



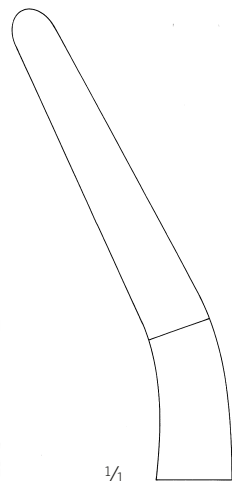
1/2

Cottle-Walsham  
37-724-01-07 -  
37-724-03-07  
23 cm / 9"



1/2

Asch  
37-725-23-07  
22,5 cm / 8 7/8"



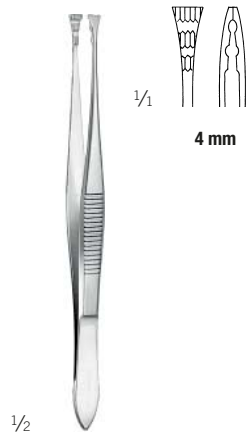
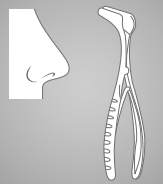
1/1

## Hautfasspinzetten, Antrumküretten

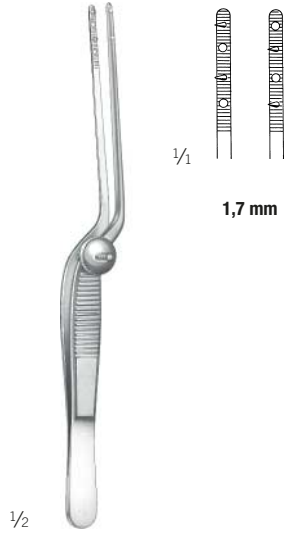
Skin Grasping Forceps, Antrum Curettes  
 Pinzas para piel, Curetas para el antro  
 Pincés pour saisir la peau, Curettes pour l'antro  
 Pinze per afferrare la pelle, Curette per antro

## Rhinologie

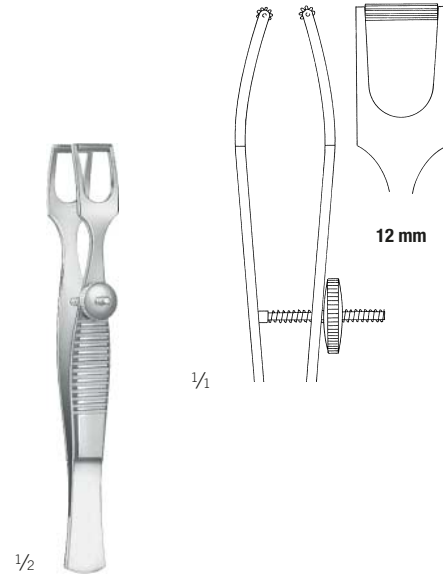
Rhinology  
 Rinología  
 Rinologie  
 Rinologia



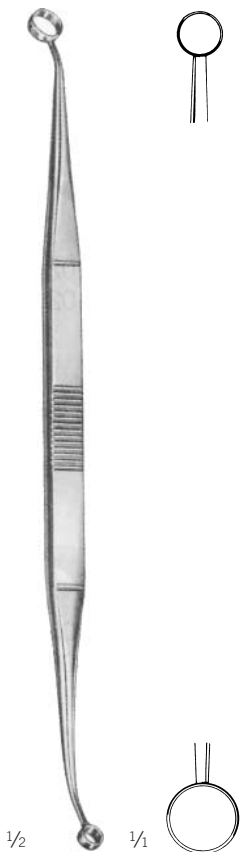
Ogura  
 37-728-11-07  
 11 cm / 4 3/8"



Cottle  
 37-731-14-07  
 14 cm / 5 1/2"  
 mit Zähnen  
 with teeth  
 con dientes  
 avec dents  
 con denti



Cottle  
 37-732-10-07  
 11 cm / 4 3/8"  
 Columellapinzette  
 Columella Forceps  
 Pinza para columela  
 Pince à columella  
 Pinza per columella



Faulkner  
 37-742-21-07  
 21 cm / 8 1/8"



Coakley  
 37-748-01-07 -  
 37-748-06-07  
 17 cm / 6 5/8"



Fig. 1  
 37-748-01-07



Fig. 2  
 37-748-02-07

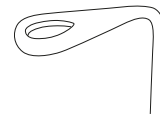


Fig. 3  
 37-748-03-07



Fig. 4  
 37-748-04-07



Fig. 5  
 37-748-05-07



Fig. 6  
 37-748-06-07

## Ringmesser, Saugraspatorium, Sinus-Dilatatoren

Adenoid Currettes, Suction Raspatory, Frontal Sinus Dilators

Cuchillos para adenoides, Legra de succión, Dilatadores para el seno

Couteaux à végétations adénoïdales, Rugine-raspatoire à succion, Dilatateurs pour le sinus frontal

Coltelli per vegetazioni adenoidee, Rasparatorio con aspiratore, Dilatatori per il seno frontale

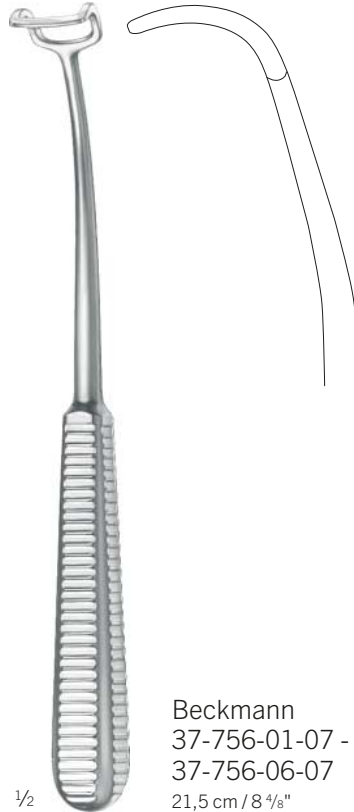


1/1

|               |              |       |
|---------------|--------------|-------|
| <b>Fig. 1</b> | 37-755-01-07 | 13 mm |
| <b>Fig. 2</b> | 37-755-02-07 | 15 mm |
| <b>Fig. 3</b> | 37-755-03-07 | 17 mm |
| <b>Fig. 4</b> | 37-755-04-07 | 19 mm |
| <b>Fig. 5</b> | 37-755-05-07 | 21 mm |
| <b>Fig. 6</b> | 37-755-06-07 | 23 mm |

Beckmann  
37-755-01-07 -  
37-755-06-07  
22 cm / 8 5/8"

1/2



1/1

|               |              |       |
|---------------|--------------|-------|
| <b>Fig. 1</b> | 37-756-01-07 | 13 mm |
| <b>Fig. 2</b> | 37-756-02-07 | 15 mm |
| <b>Fig. 3</b> | 37-756-03-07 | 17 mm |
| <b>Fig. 4</b> | 37-756-04-07 | 19 mm |
| <b>Fig. 5</b> | 37-756-05-07 | 21 mm |
| <b>Fig. 6</b> | 37-756-06-07 | 23 mm |

Beckmann  
37-756-01-07 -  
37-756-06-07  
21,5 cm / 8 4/8"

1/2



Ø 3,0 mm

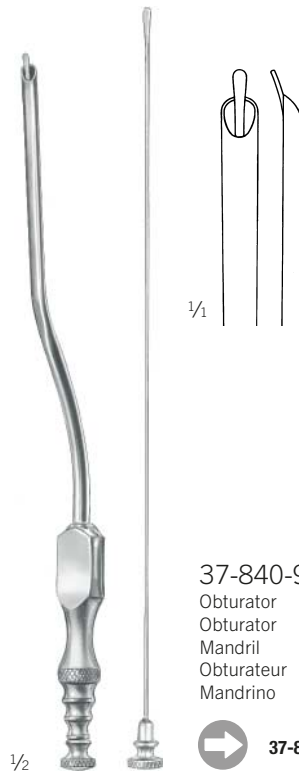
1/1

37-814-30-07

1/2

Eicken-Killian  
37-814-30-07  
14 cm / 5 4/8"

Spülkanüle, mit Luer-Lock  
Irrigation Cannula, with Luer-Lock  
Sonda irrigadora para seno maxilar, con Luer-Lock  
Canule à irrigation, avec Luer-Lock  
Cannula per lavaggio, con Luer-Lock



1/1

37-840-90-98  
Obturator  
Obturator  
Mandril  
Obturateur  
Mandrino

➔ 37-840-20-01

1/2

Guilen  
37-840-20-01  
19 cm / 7 4/8"



Ø 3 mm

37-842-30-01

Ø 4 mm

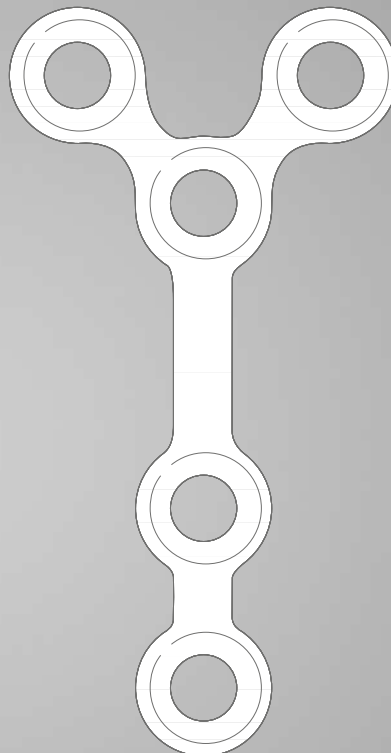
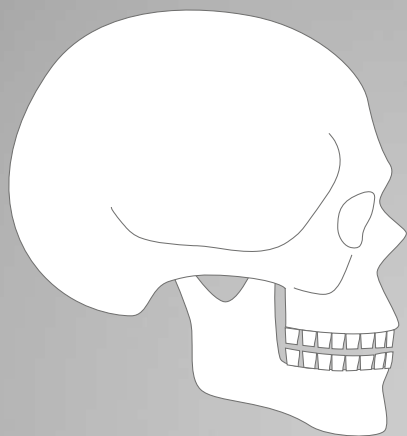
37-842-40-01

1/2

Ritter-Halle  
37-842-30-01 -  
37-842-40-01  
14,5 cm / 5 6/8"

Mund-, Kiefer- und Gesichtschirurgie  
Oral Maxillo-facial Surgery  
Cirugía oral y maxilofacial  
Chirurgie buccale et maxillo-faciale  
Chirurgia maxillo-facciale

# 38, 48, 50



## Spezial-Produkte

Special Products

Productos especiales

Produits spéciaux

Prodotti speciali

Unser Ordner-System und Katalog „Craniomaxillofacial Surgery“ enthält die gesamte Palette der KLS-Martin-Implantate und -Instrumente für die Mund-, Kiefer- und Gesichtschirurgie.

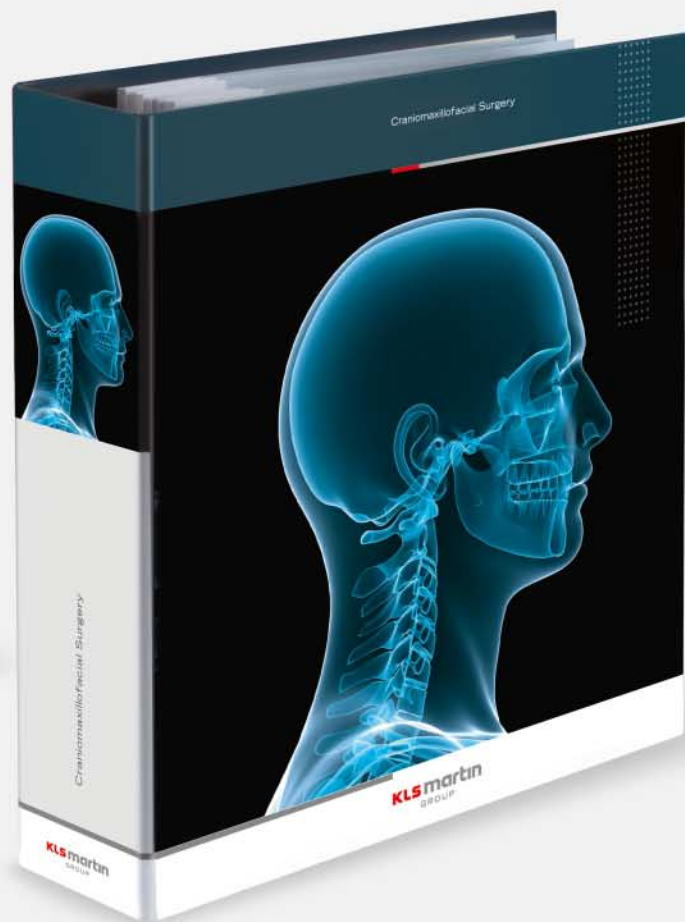
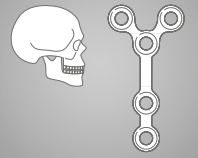
Our folder system and catalog “Craniomaxillofacial Surgery” contains the full range of KLS-Martin implants and instruments for cranio-maxillofacial surgery.

Nuestro sistema de carpetas y catálogo “Craniomaxillofacial Surgery” incluye la gama completa de implantes e instrumentos de KLS-Martin para la cirugía oral y maxilofacial.

Notre système de dossiers et catalogue «Craniomaxillofacial Surgery» contient l'ensemble de la palette des implants et instruments KLS Martin pour la chirurgie buccale et maxillofaciale.

Il nostro sistema di cartelle e catalogo “Craniomaxillofacial Surgery” contiene la gamma completa degli impianti e degli strumenti di KLS Martin per la chirurgia orale-maxillo-facciale.

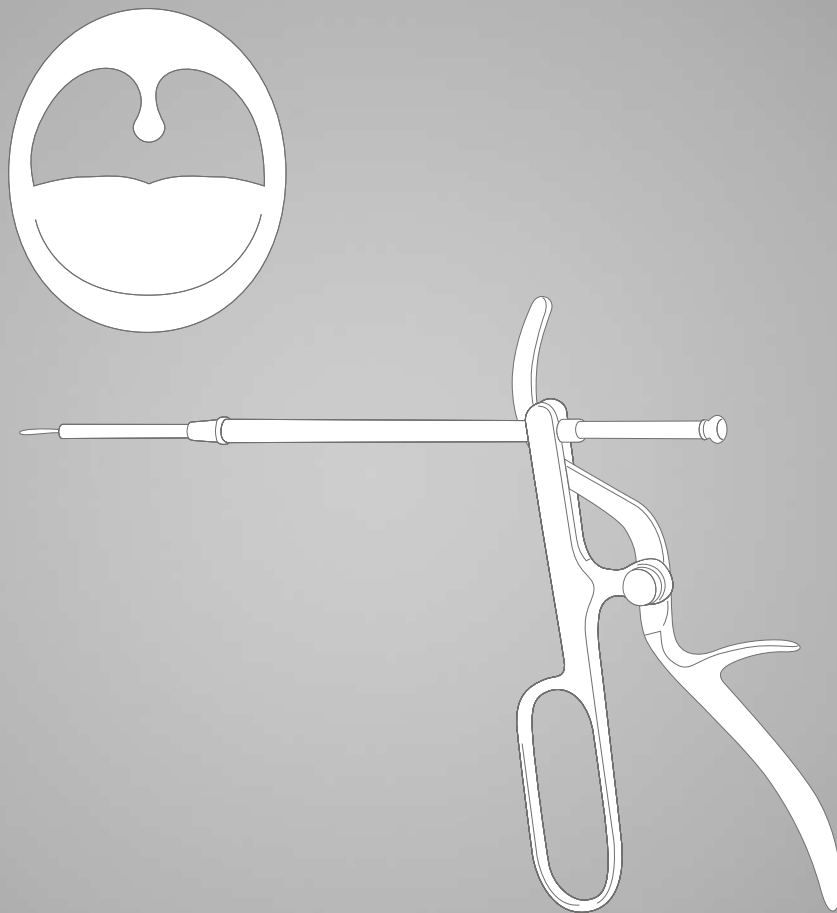






# 39

Tonsillektomie, Laryngo-Bronchoskopie  
Tonsillectomy, Laryngo-Bronchoscopy  
Tonsilectomía, Laringo-Bronhoscopía  
Tonsillectomie, Laryngo-Bronchoscopie  
Tonsilectomia, Laringo-Bronhoscopia



## Gaumenspalten-Instrumente

Cleft Palate Instruments

Instrumentos paladares

Instruments pour palais

Strumenti per palato

|   |  |  |   |   |
|---|--|--|---|---|
|   |  <p>1/1</p>   |   |    |    |
|   | <p><b>3,9 mm</b><br/>39-001-18-07</p> <p>Gaumenspalten-Häkchen, kurz<br/>Cleft Palate Hooklet, short<br/>Ganchito para el paladar, corto<br/>Crochet pour palais, court<br/>Uncino per palato, corto</p> | <p><b>5,5 mm</b><br/>39-003-18-07</p> <p>Gaumenspalten-Häkchen, lang<br/>Cleft Palate Hooklet, long<br/>Ganchito para el paladar, larga<br/>Crochet pour palais, longue<br/>Uncino per palato, lunga</p> | <p><b>3,3 mm</b><br/>39-011-18-07</p> <p>Gaumenspalten-Dissektor, kurz<br/>Cleft Palate Dissector, short<br/>Disecador para el paladar, corto<br/>Dissecteur pour palais, court<br/>Disettore per palato, corto</p> | <p><b>3,7 mm</b><br/>39-013-18-07</p> <p>Gaumenspalten-Dissektor, lang<br/>Cleft Palate Dissector, long<br/>Disecador para el paladar, larga<br/>Dissecteur pour palais, longue<br/>Disettore per palato, lunga</p>               |
|  |  <p>1/1</p>  |    |   |   |
|   | <p><b>Salyer</b><br/>39-001-18-07 -<br/>39-027-18-07<br/>18 cm / 7 1/8"</p>  | <p><b>3,7 mm</b><br/>39-021-18-07</p> <p>Gaumenspalten-Elevatorium<br/>Cleft Palate Instruments<br/>Instrumentos paladares<br/>Instruments pour palais<br/>Strumenti per palato</p>                      | <p><b>3,6 mm</b><br/>39-023-18-07</p> <p>Gaumenspalten-Elevatorium<br/>Cleft Palate Elevator<br/>Elevador para el paladar<br/>Elévateur pour palais<br/>Elevatore per palato</p>                                    | <p><b>2,9 mm</b><br/>39-027-18-07</p> <p>Gaumenspalten-Elevatorium, graduert<br/>Cleft Palate Elevator, graduated<br/>Elevador para el paladar, graduado<br/>Elévateur pour palais, gradué<br/>Elevatore per palato, graduato</p> |
|  |  <p>1/1</p>   |   |   |   |
|   | <p><b>4 mm</b><br/>39-101-18-07</p> <p>links<br/>left<br/>izquierdo<br/>gauche<br/>sinistra</p>  | <p><b>4 mm</b><br/>39-102-18-07</p> <p>rechts<br/>right<br/>derecho<br/>droit<br/>destra</p>   |   |   |
| <p>39-101-18-07 -<br/>39-102-18-07<br/>14 cm / 5 4/8"</p>                           |  |  |   |   |

## Tonsillennmesser, Tonsillenelevatorien

Tonsil Knife, Tonsil Dissectors

Cuchillo, Disectores para amígdalas

Bistouri pour amygdales, Dissecteurs pour amygdales

Bisturi per tonsille, Disettori per tonsille

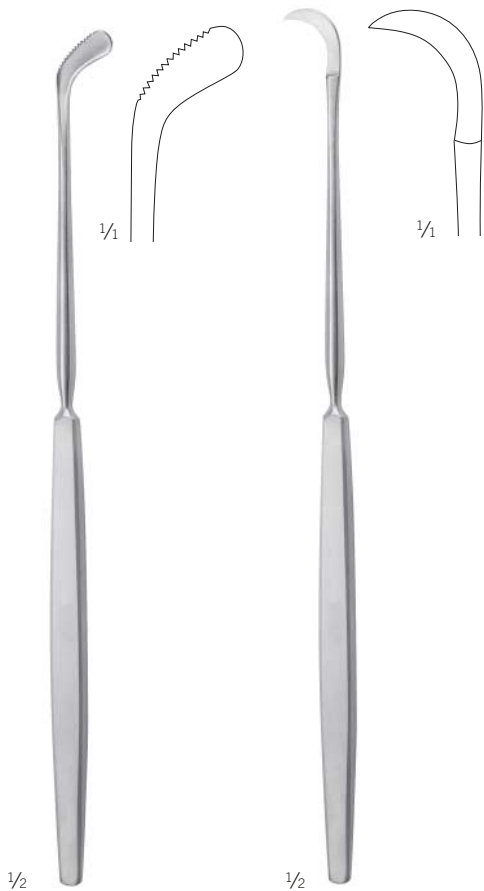
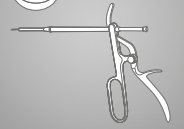
## Tonsillektomie, Laryngo-Bronchoskopie

Tonsillectomy, Laryngo-Bronchoscopy

Tonsilectomía, Laringo-Bronchoscopia

Tonsillectomie, Laryngo-Bronchoscopie

Tonsilectomia, Laringo-Bronchoscopia



Fisher  
39-220-22-07  
22,5 cm / 8 7/8"

Brünings  
39-228-23-07  
23 cm / 9"



Hurd  
39-281-22-07  
22,5 cm / 8 7/8"  
Tonsillenelevator / Retraktor  
Tonsil Dissector / Retractor  
Disector / Separador para amígdalas  
Dissecteur / Rétracteur pour amygdales  
Disettore / Retrattore per tonsille

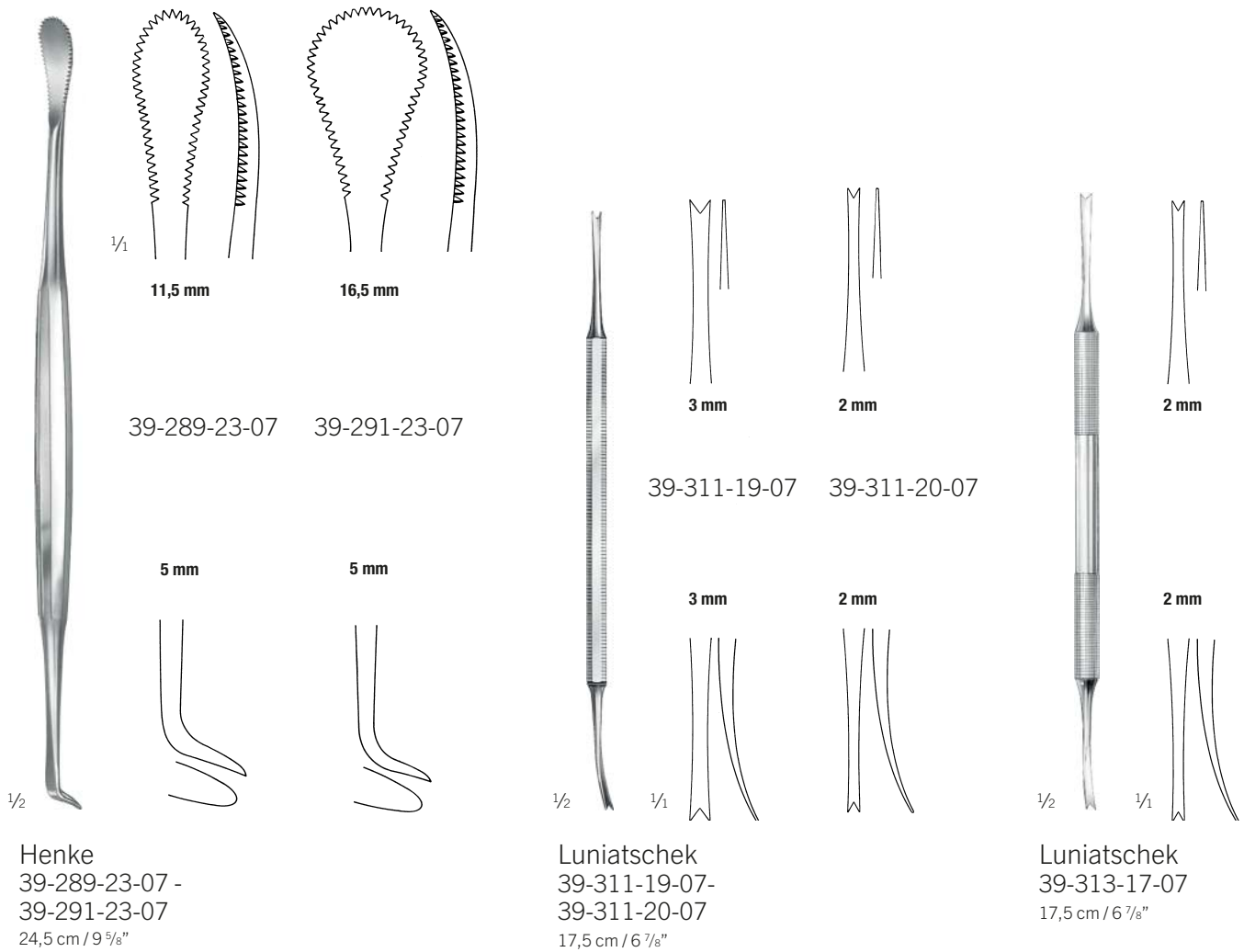
## Tonsillenelevatorien, Tamponstopfer

Tonsil Dissectors, Gauze Packers

Disectores para amígdalas, Taponeadores

Dissecteurs pour amygdales, Porte-tampon

Disettori per tonsille, Tamponatori

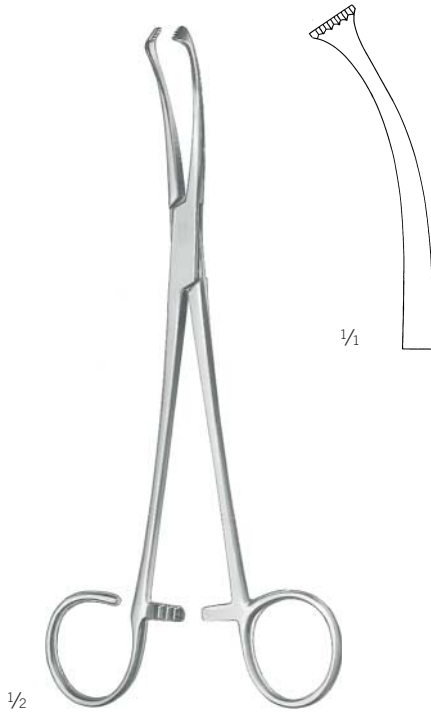
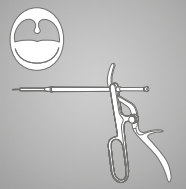


## Tonsillenklemmen

Tonsil Forceps  
Pinzas para amígdalas  
Pincas pour amygdales  
Pinze per tonsille

## Tonsillektomie, Laryngo-Bronchoskopie

Tonsillectomy, Laryngo-Bronchoscopy  
Tonsilectomía, Laringo-Bronchoscopia  
Tonsillectomie, Laryngo-Bronchoscopie  
Tonsilectomia, Laringo-Bronchoscopia



1/2

White  
39-419-18-07  
18 cm / 7 1/8"

Tonsillenfasszange  
Tonsil Grasping Forceps  
Pinza para amígdalas  
Pince pour amygdales  
Pinze per tonsille



1/2

Blohmke  
39-423-20-07  
20 cm / 7 1/8"

Tonsillenfasszange  
Tonsil Grasping Forceps  
Pinza para amígdalas  
Pince pour amygdales  
Pinze per tonsille

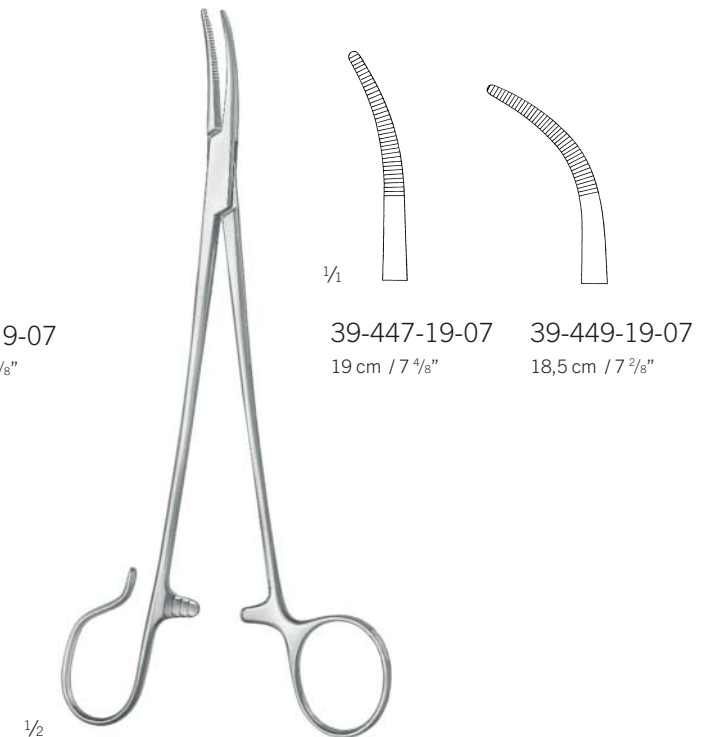


1/2

Schnidt  
39-443-19-07 -  
39-445-19-07

39-443-19-07  
19 cm / 7 4/8"

39-445-19-07  
18,5 cm / 7 2/8"



1/2

Schnidt  
39-447-19-07 -  
39-449-19-07

39-447-19-07  
19 cm / 7 4/8"

39-449-19-07  
18,5 cm / 7 2/8"

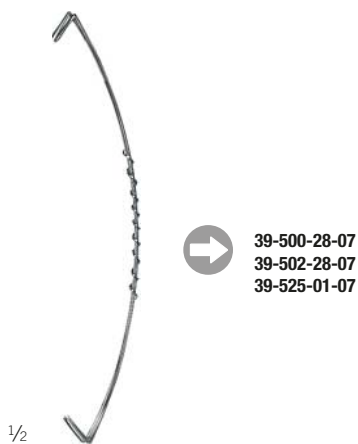
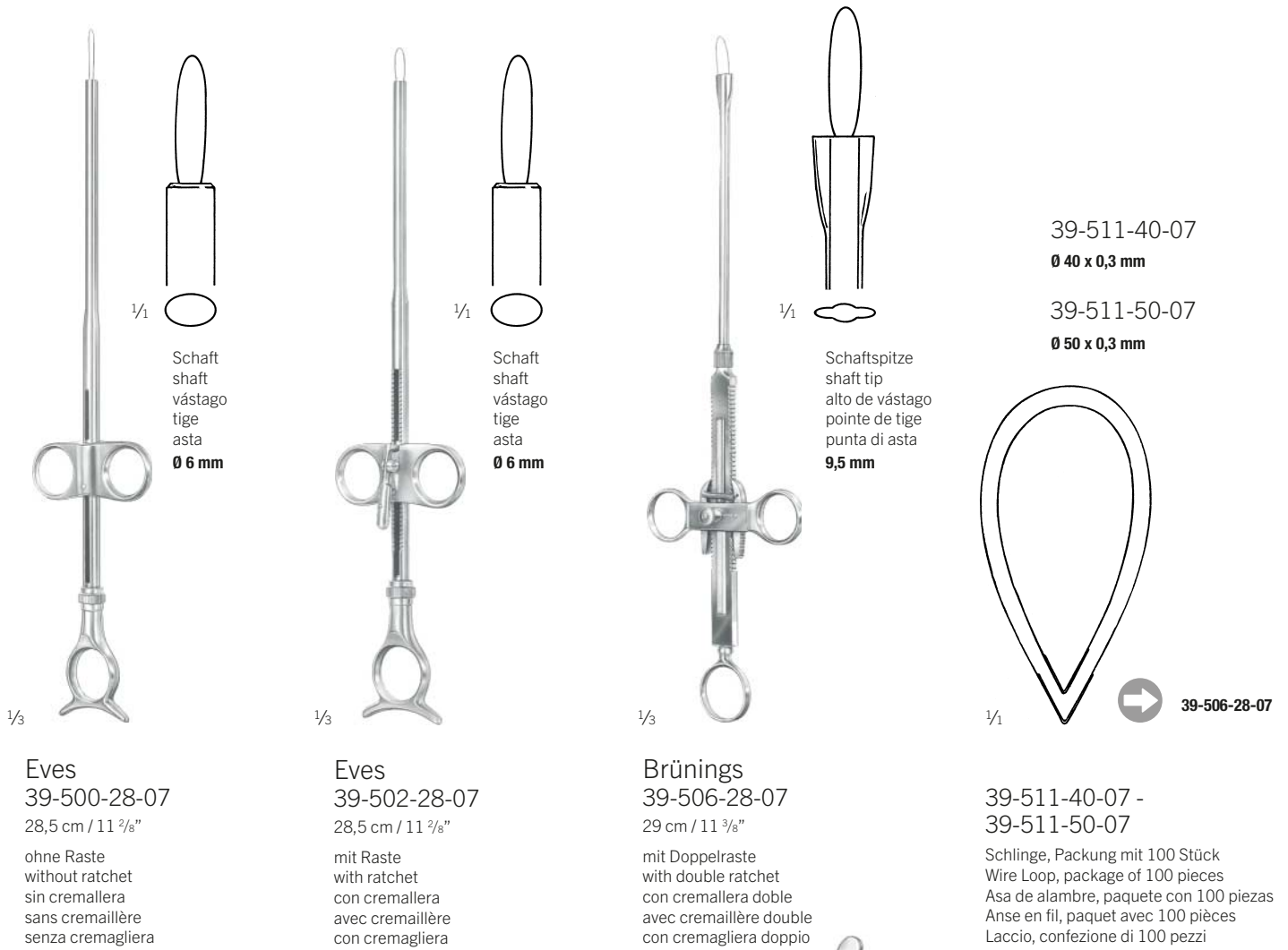
## Tonsillenschnürer

Tonsil Snares

Cierra-nudos para amígdalas

Serre-noeuds pour amygdales

Serranodi per tonsille



Ø 0,3 mm  
39-513-01-07

Schnürdraht, Packung mit 100 Stück  
Snare Wire, package of 100 pieces  
Alambre para asas, paquete con 100 piezas  
Fil pour anses, paquet avec 100 pièces  
Filo per legare, confezione di 100 pezzi

Tyding  
39-525-01-07

mit einem geraden Aufsatz  
with one straight tip  
con una punta recta  
avec une pointe droite  
con una punta diritta





## Broncho-Oesophagoskopiezangen

Broncho-Esophagoscopy Forceps

Pinzas para Broncho-Esofagoscopia

Pinces pour Broncho-Esofagoscopie

Pinze per Broncho-Esofagoscopia

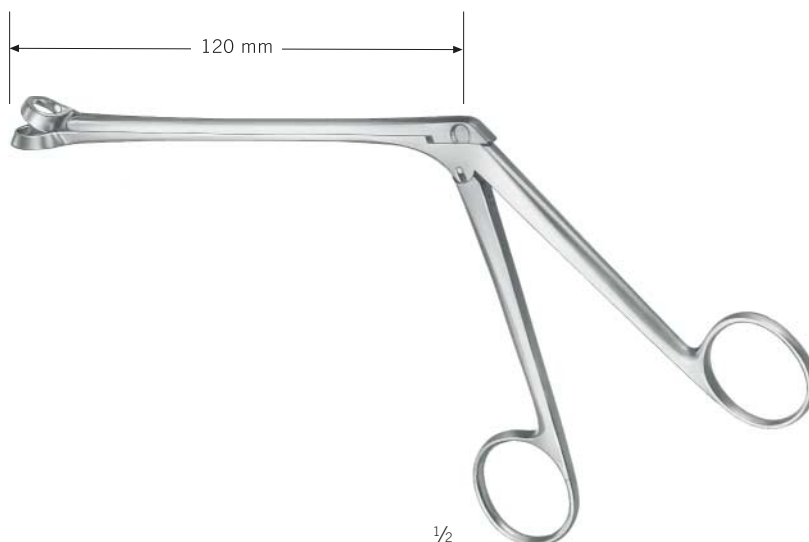
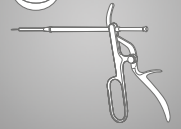
## Laryngo-Bronchoskopie

Tonsillectomy, Laryngo-Bronchoscopy

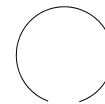
Tonsilectomía, Laringo-Bronchoscopía

Tonsillectomie, Laryngo-Bronchoscopie

Tonsilectomia, Laringo-Bronchoscopia



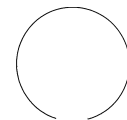
1/1



39-541-13-07

Schnitt  
cut  
corte  
tranchant  
tagliente  
**Ø 13 mm**

Schaftlänge  
shaft length  
longitud del vástago  
longueur de la tige  
lunghezza dell'asta  
**120 mm**



39-541-15-07

Schnitt  
cut  
corte  
tranchant  
tagliente  
**Ø 15 mm**

Schaftlänge  
shaft length  
longitud del vástago  
longueur de la tige  
lunghezza dell'asta  
**120 mm**

1/2

Hartmann  
39-541-13-07 -  
39-541-15-07

Tonsillenzange, durchschneidend  
Tonsil Punchthrough-cutting  
Pinzas para amígdalas, cortante  
Pince pour amygdales, tranchante  
Pinza per tonsille, tagliente

# Broncho-Oesophagoskopiezangen

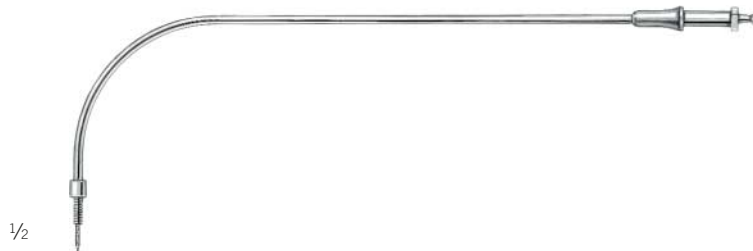
Broncho-Esophagoscopy Forceps  
 Pinzas para Broncho-Esofagoscopia  
 Pinces pour Broncho-Esofagoscopie  
 Pinze per Broncho-Esofagoscopia



## Brünings

|              |                 |
|--------------|-----------------|
| 39-584-20-07 | 22 cm / 8 5/8"  |
| 39-584-30-07 | 32 cm / 12 5/8" |
| 39-584-40-07 | 41 cm / 16 1/8" |

➔ 39-581-01-07



Brünings  
 39-587-20-07  
 18 cm / 7 1/8"

➔ 39-581-01-07



Huber  
 39-581-01-07

für Verlängerungsrohre 39-584-20-07 - 39-587-20-07  
 for interchangeable tubes 39-584-20-07 - 39-587-20-07  
 para tubos de extension 39-584-20-07 - 39-587-20-07  
 pour tubes rallonges 39-584-20-07 - 39-587-20-07  
 per tubi allunghi 39-584-20-07 - 39-587-20-07

**Auswechselbare Zangenaufsätze**  
**Exchangeable Tips**  
**Pinzas intercambiables**  
**Embouts interchangeables**  
**Pinze intercambiabili**

**Schnittbreite**  
**Cutting width**  
**Ancho de cortar**  
**Largeur de coupe**  
**Ampiezza di taglio**

1/1 3 mm

1/1 2,5 mm



Fraenkel  
 39-600-01-07

Seiffert  
 39-604-01-07

1/1 4 mm



1/1 3 mm



Fraenkel  
 39-608-01-07

Brünings  
 39-616-02-07 - 39-616-03-07

**Fig. 2**  
 39-616-02-07

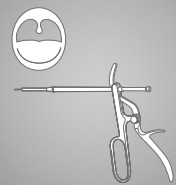
4 mm  
**Fig. 3**  
 39-616-03-07

## Auswechselbare Zangenaufsätze

Exchangeable Tips  
Pinzas intercambiables  
Embouts interchangeables  
Pinze intercambiabili

## Laryngo-Bronchoskopie

Tonsillectomy, Laryngo-Bronchoscopy  
Tonsilectomía, Laringo-Bronchoscopia  
Tonsillectomie, Laryngo-Bronchoscopie  
Tonsilectomia, Laringo-Bronchoscopia



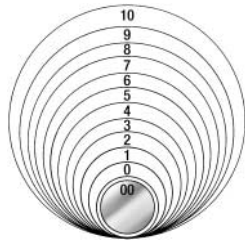
# Kehlkopfspiegel

Laryngeal Mirrors

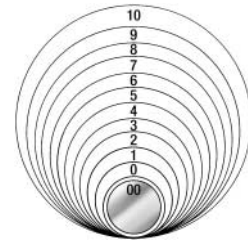
Espejos laringeos

Miroirs laryngiens

Specchi laringei



|        |              |         |
|--------|--------------|---------|
| Fig. 3 | 39-781-16-01 | Ø 16 mm |
| Fig. 4 | 39-781-18-01 | Ø 18 mm |
| Fig. 5 | 39-781-20-01 | Ø 20 mm |
| Fig. 6 | 39-781-22-01 | Ø 22 mm |
| Fig. 7 | 39-781-24-01 | Ø 24 mm |
| Fig. 8 | 39-781-26-01 | Ø 26 mm |



|        |              |         |
|--------|--------------|---------|
| Fig. 3 | 39-785-16-01 | Ø 16 mm |
| Fig. 4 | 39-785-18-01 | Ø 18 mm |
| Fig. 5 | 39-785-20-01 | Ø 20 mm |
| Fig. 6 | 39-785-22-01 | Ø 22 mm |
| Fig. 7 | 39-785-24-01 | Ø 24 mm |
| Fig. 8 | 39-785-26-01 | Ø 26 mm |
| Fig. 9 | 39-785-28-01 | Ø 28 mm |



1/2

| rhodiumbeschichtet<br>rhodium plated<br>cubierto de rodio<br>plaqué du rhodium<br>coperto di rodio |              |         |
|--|--------------|---------|
| Fig. 00  | 39-782-08-04 | Ø 8 mm  |
| Fig. 0   | 39-782-10-04 | Ø 10 mm |
| Fig. 1   | 39-782-12-04 | Ø 12 mm |
| Fig. 2   | 39-782-14-04 | Ø 14 mm |
| Fig. 3   | 39-782-16-04 | Ø 16 mm |
| Fig. 4   | 39-782-18-04 | Ø 18 mm |
| Fig. 5   | 39-782-20-04 | Ø 20 mm |
| Fig. 6   | 39-782-22-04 | Ø 22 mm |
| Fig. 7   | 39-782-24-04 | Ø 24 mm |
| Fig. 8   | 39-782-26-04 | Ø 26 mm |
| Fig. 9   | 39-782-28-04 | Ø 28 mm |
| Fig. 10  | 39-782-30-04 | Ø 30 mm |



1/2

| rhodiumbeschichtet<br>rhodium plated<br>cubierto de rodio<br>plaqué du rhodium<br>coperto di rodio |              |         |
|--|--------------|---------|
| Fig. 00  | 39-786-08-04 | Ø 8 mm  |
| Fig. 0   | 39-786-10-04 | Ø 10 mm |
| Fig. 1   | 39-786-12-04 | Ø 12 mm |
| Fig. 2   | 39-786-14-04 | Ø 14 mm |
| Fig. 3   | 39-786-16-04 | Ø 16 mm |
| Fig. 4   | 39-786-18-04 | Ø 18 mm |
| Fig. 5   | 39-786-20-04 | Ø 20 mm |
| Fig. 6   | 39-786-22-04 | Ø 22 mm |
| Fig. 7   | 39-786-24-04 | Ø 24 mm |
| Fig. 8   | 39-786-26-04 | Ø 26 mm |
| Fig. 9   | 39-786-28-04 | Ø 28 mm |
| Fig. 10  | 39-786-30-04 | Ø 30 mm |

39-781-16-01 -  
39-782-30-04

18,5 cm / 7 3/8"  
plan, mit festem Handgriff  
plane, with fixed handle  
plano, con mango fijado  
plat, avec manche fixe  
plano, con manico fisso

39-785-16-01 -  
39-786-30-04

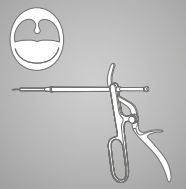
13,5 cm / 5 3/8"  
plan, ohne Handgriff  
plane, without handle  
plano, sin mango  
plat, sans manche  
plano, senza manico

## Kehlkopfspiegel -und Griffe

Laryngeal Mirrors, Laryngeal Mirror Handles  
Espejos laringeos, Mangos para espejos laringeos  
Miroirs laryngiens, Manche pour miroirs laryngiens  
Specchi laringei, Manico per specchi laringei

## Tonsillektomie, Laryngo-Bronchoskopie

Tonsillectomy, Laryngo-Bronchoscopy  
Tonsilectomía, Laringo-Bronchoscopia  
Tonsillectomie, Laryngo-Bronchoscopie  
Tonsilectomia, Laringo-Bronchoscopia



Cr



1/1



**Fig. 1**  
39-789-12-02  
Ø 12 mm



**Fig. 2**  
39-789-14-02  
Ø 14 mm



**Fig. 3**  
39-789-16-02  
Ø 16 mm



**Fig. 4**  
39-789-18-02  
Ø 18 mm

1/2

Michel  
39-789-12-02 -  
39-789-18-02

27 cm / 10 5/8"

beweglicher Spiegel  
moveable mirror  
espejo movable  
miroir mobile  
specchio mobile

1/2



39-794-11-02  
11 cm / 4 3/8"

➔ 39-785-08-01 -  
39-786-30-04

1/2



39-798-12-02  
12,5 cm / 4 7/8"

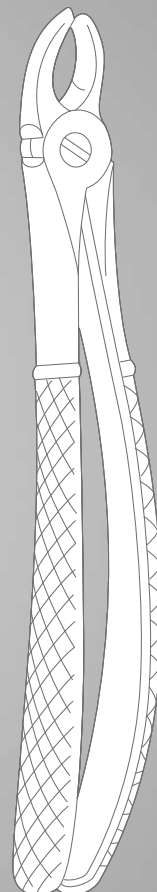
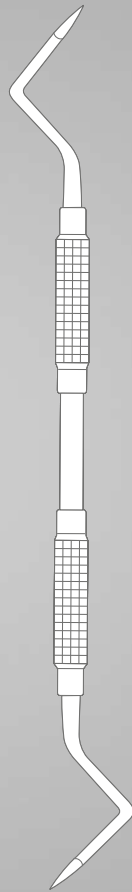
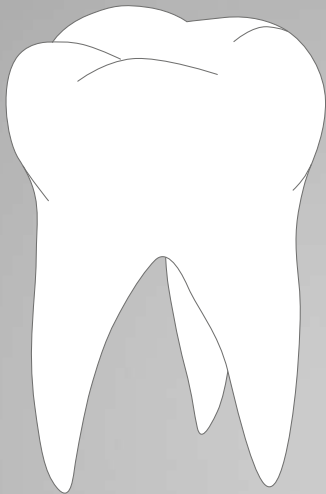
➔ 39-785-08-01 -  
39-786-30-04

39



Dental- und Oralchirurgie  
Dental and Oral Surgery  
Cirugía dental y oral  
Chirurgie dentaire et orale  
Chirurgia dentale e orale

# 40-47



## Spezial-Produkte

Special Products

Productos especiales

Produits spéciaux

Prodotti speciali

Unser Katalog „Dental/Oral“ enthält die gesamte Palette der KLS-Martin-Dental-Instrumente.

Our catalog “Dental/Oral” contains the full range of KLS Martin dental instruments.

Nuestro catálogo “Dental/Oral” incluye la gama completa de instrumentos dentales de KLS Martin.

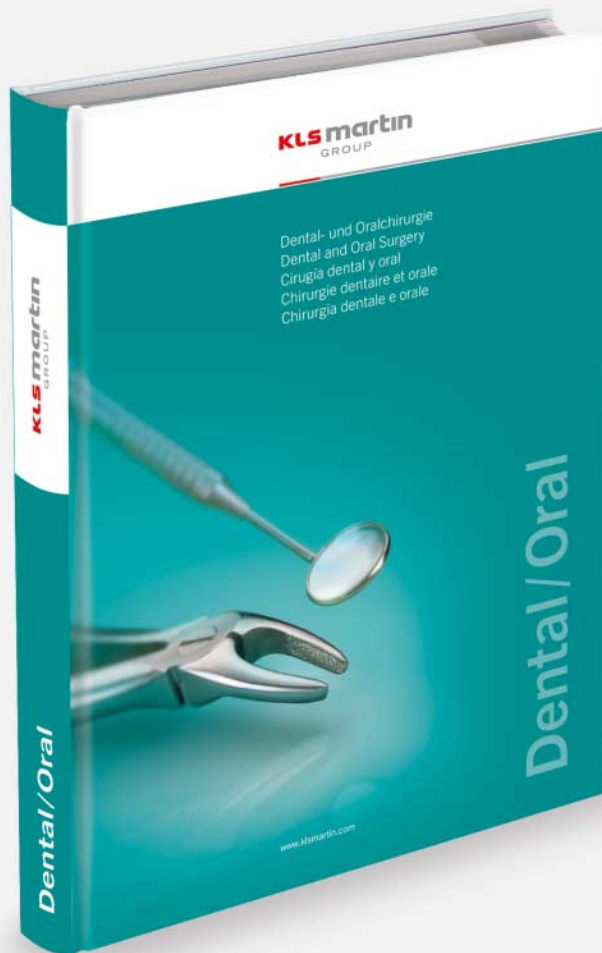
Notre catalogue « Dental/Oral » contient l’ensemble de la palette des instruments dentaires KLS Martin.

Il nostro catalogo “Dental/Oral” contiene la gamma completa degli strumenti dentali di KLS Martin.



## Dental- und Oralchirurgie

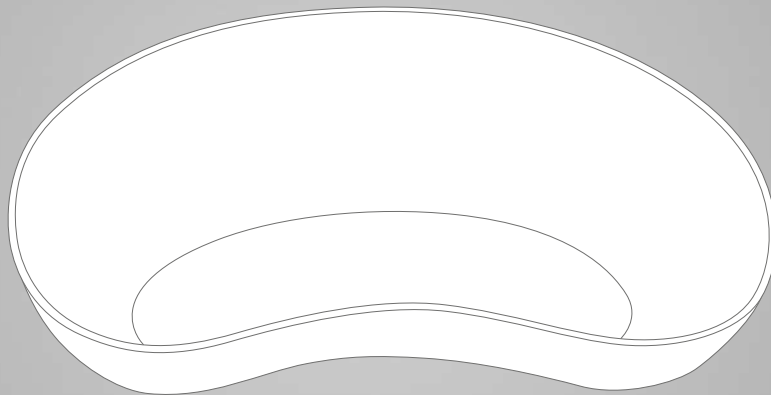
Dental and Oral Surgery  
Cirugía dental y oral  
Chirurgie dentaire et orale  
Chirurgia dentale e orale





Verschiedenes  
Miscellaneous  
Diversos artículos  
Articles divers  
Articoli diversi

# 54-73



## Handwaschbürste, Bürstenspender

Hand and Nail Brush, Brush Dispensers  
Cepillo para uñas, Dispensadores de cepillos  
Brosse à ongles, Distributeurs de brosses  
Spazzola per unghie, Distributore per spazzole

St  
18/8



Martin-Aseptic  
54-100-01-04

**110 x 40 x 35 mm (l x b x h)**

Kunststoff, mehr als 400 x autoklavierbar  
plastic, more than 400 x autoclavable  
plástico, más que 400 x autoclavable  
matière plastique, stérilisable à autoclave 400 fois et plus  
plastico, sterilizzabile più di 400 volte in autoclave



Martin  
54-150-10-01

**265 x 165 x 65 mm (l x b x h)**

für 10 Bürsten (ohne Bürsten)  
for 10 brushes (without brushes)  
para 10 cepillos (sin cepillos)  
pour 10 brosses (sans brosses)  
per 10 spazzole (senza spazzole)

mit Aufhängevorrichtung  
with suspension  
con suspensión  
avec suspension  
con suspensioe

## Bürstenspender

Brush Dispensers  
Dispensadores de cepillos  
Distributeurs de brosses  
Distributore per spazzole

## Verschiedenes

Miscellaneous  
Diversos artículos  
Articles divers  
Articoli diversi



St  
18/8



Martin

54-150-20-01

**275 x 240 x 65 mm (l x b x h)**

für 20 Bürsten (ohne Bürsten)  
for 20 brushes (without brushes)  
para 20 cepillos (sin cepillos)  
pour 20 brosses (sans brosses)  
per 20 spazzole (senza spazzole)

mit Aufhängevorrichtung  
with suspension  
con suspensión  
avec suspension  
con suspensión



54-155-25-04

Kunststoff  
plastic  
plástico  
plastique  
plastico



54-150-10-01, 54-150-20-01

54-  
73

## Nagelscheren, Nagelzangen

Nail Scissors

Tijeras para uñas

Ciseaux à ongles

Forbici per unghie



1/2

54-301-10-07

Nagelschere und Nagelfeile an Kette  
nail scissors and nail file with chain  
tijeras y lima para uñas con cadena  
ciseaux à ongles et lime à ongles avec chaîne  
forbici e lima per unghie con catena



1/2

54-305-10-07

10,5 cm / 4 1/8"



1/2

54-331-14-07

14 cm / 5 4/8"



1/2

54-336-14-07

14 cm / 5 4/8"



1/2

54-347-13-07

14 cm / 5 4/8"

## Nageleckenzangen, Nagelhautzangen, Hautscheren, Nagelfeilen

Nail Nippers, Cuticle Nippers, Cuticle Scissors, Nail Files

Pinzas para cortar uñas, Pinzas cuticulares, Tijeras cuticulares, Limas para uñas

Pinces pour couper ongles, Pinces à envies, Ciseaux à envies, Limes à ongles

Tronchesine per unghie, Tronchesine per pelle, Forbici per pelle, Lime per unghie

## Verschiedenes

Miscellaneous

Diversos artículos

Articles divers

Articoli diversi



1/2

54-360-13-07

13 cm / 5 1/8"

gerade Schneiden  
straight cutting edges  
hojas cortantes rectas  
lames tranchantes droites  
parte tagliente diritta



1/2

54-373-10-07

11 cm / 4 3/8"

feines Modell  
delicate pattern  
modelo delicado  
modèle fin  
modello fino



1/2

54-378-10-07

10,5 cm / 4 1/8"

feines Modell  
delicate pattern  
modelo delicado  
modèle fin  
modello fino



1/2

54-379-10-07

10,5 cm / 4 1/8"

feines Modell  
delicate pattern  
modelo delicado  
modèle fin  
modello fino



1/2

54-386-10-07

9 cm / 3 4/8"



1/2

54-389-16-04

16 cm / 6 2/8"

Saphirbelag  
sapphire coating  
recubrimiento de zafiro  
couche en saphir  
rivestimento in zaffiro

54-73

## Infektions-Schutzbrillen

Protection Spectacles

Gafas protectoras

Lunettes protectrices

Occhiali protettivi

---



54-406-00-04



---

Verschiedenes  
Miscellaneous  
Diversos artículos  
Articles divers  
Articoli diversi

# 55

## Spezial-Produkte

Special Products

Productos especiales

Produits spéciaux

Prodotti speciali

Unser Katalog „Steriltechnik“ enthält die gesamte Palette der KLS-Martin-Sterilisationscontainer- und Siebkorbssysteme.

Our catalog “Sterile Technology” contains the full range of KLS-Martin sterilizing containers and perforated sterilization baskets.

Nuestro catálogo “Técnica de esterilización” incluye la gama completa de contenedores de esterilización y sistemas de bandejas cribadas de KLS-Martin.

Notre catalogue «Technologie stérile» contient l'ensemble de la palette des conteneurs de stérilisation et paniers à mailles KLS Martin.

Il nostro catalogo “Tecnica di sterilizzazione” contiene la gamma completa dei sistemi di contenitori di sterilizzazione e vassoi reticolati di KLS Martin.

**KLS martin**  
GROUP

**Steriltechnik**  
Sterilisationscontainer- und Siebkorb-Systeme

[www.klsmartin.com](http://www.klsmartin.com)

54-  
73

## Sterilisierzange

Sterilizing Forceps

Pinzas para esterilización

Pinces pour instruments stérilisés

Pinze per strumenti sterilizzati



1/3

Cheattle  
55-085-27-07  
27 cm / 10 <sup>5</sup>/<sub>8</sub>"



1/3

55-091-30-07  
30 cm / 11 <sup>3</sup>/<sub>8</sub>"

## Nadeldosen

Needle Cases  
Estuches para agujas  
Boîtes pour aiguilles  
Scatole per aghi

## Verschiedenes

Miscellaneous  
Diversos artículos  
Articles divers  
Articoli diversi



ca. 1/3

Sauerbruch  
55-162-20-01

**210 x 125 x 17 mm (l x b x h)**

Deckel und Boden perforiert  
perforated lid and bottom  
tapa y fondo perforado  
couvercle et fond perforé  
coperchio e fondo perforati

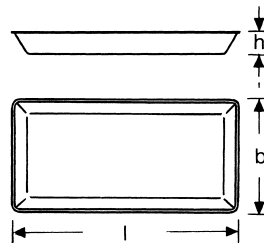


ca. 1/3

Sauerbruch  
55-164-20-01

**210 x 125 x 17 mm (l x b x h)**

Deckel und Boden perforiert  
perforated lid and bottom  
tapa y fondo perforado  
couvercle et fond perforé  
coperchio e fondo perforati



|              |                  |
|--------------|------------------|
| 55-302-50-01 | 50 x 25 x 4,5 mm |
| 55-302-65-01 | 65 x 42 x 8 mm   |
| 55-302-75-01 | 75 x 25 x 4,5 mm |

54-  
73

## Nadeldosen

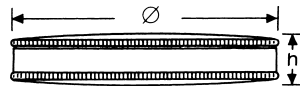
Needle Cases

Estuches para agujas

Boîtes pour aiguilles

Scatole per aghi

St  
18/6



55-309-65-01

**h = 18 mm Ø 67 mm**

komplett mit perforierter Innendose  
complete with perforated interior box  
completa con caja interior perforada  
complet avec boîte intérieure perforée  
completo con scatola interiore perforata

55-310-65-01

**h = 15 mm Ø 61 mm**

Innendose, Deckel und Boden perforiert  
Interior Box, perforated lid and bottom  
Caja interior, tapa y fondo perforado  
Boîte intérieure, couvercle et fond perforé  
Scatola per aghi, coperchio e fondo perforati



55-335-02-01

**150 x 95 x 13 mm (l x b x h)**

Deckel und Boden perforiert  
perforated lid and bottom  
tapa y fondo perforado  
couvercle et fond perforé  
coperchio e fondo perforati

## Nadelkassetten, Bereitstellungsbecher

Needle Cases, Storing Cup

Estuches para agujas, Tarro para instrumentos

Boîtes pour aiguilles, Goblet pour instruments

Scatole per aghi, Contenitore per strumenti

## Verschiedenes

Miscellaneous

Diversos artículos

Articles divers

Articoli diversi



St  
18/8



1/4

55-337-02-01

**150 x 95 x 13 mm (l x b x h)**

Deckel und Boden perforiert

perforated lid and bottom

tapa y fondo perforado

couvercle et fond perforé

coperchio e fondo perforati



55-348-00-01

**h = 75 mm Ø 75 mm**

für Mikroinstrumente, mit auswechselbarer Silikon-Bodenplatte

for micro instruments, with exchangeable silicone plate

para micro instrumentos, con plaquita de silicona cambiabile

pour micro instruments, avec plaque de fond en silicone interchangeable

per micro strumenti, con stuoia di silicone intercambiabile

55-348-01-01

Silikoneinlage

Silicone plate

Plaquita de silicona

Plaque de silicone

Stuoia in silicone



55-348-00-01

54-  
73

## Kappenzangen, Sterilisierklammer

Dressing Forceps in jar with cap, Safety Pins  
Pinza en tarro con tapa, Imperdibles para instrumentos  
Combinaison couvercle/pince, Clips de stérilisation  
Pinza-coperchio, Pinze per sterilizzazione

St  
18/6



1/3

Mod. Martin  
55-358-25-01

Standgefäß 20,5 cm hoch,  
mit 25 cm langer Kornzange  
jar 20,5 cm high,  
with 25 cm long dressing forceps  
tarro 20,5 cm de altura,  
con pinza de vendaje de 25 cm  
goblet 20,5 cm de hauteur,  
avec pince à pansement de 25 cm longueur  
contenitore 20,5 cm di altezza,  
con pinza per medicatura di 25 cm di lunghezza



Mod. Martin  
55-358-32-01

Standgefäß 25,5 cm hoch,  
mit 32 cm langer Kornzange  
jar 25,5 cm high,  
with 32 cm long dressing forceps  
tarro 25,5 cm de altura,  
con pinza de vendaje de 32 cm  
goblet 25,5 cm de hauteur,  
avec pince à pansement de 25 cm longueur  
contenitore 25,5 cm di altezza,  
con pinza per medicatura di 32 cm di lunghezza



1/2

Mayo  
55-805-14-01  
14 cm / 5 4/8"



1/2

Mayo  
55-808-14-01  
14 cm / 5 4/8"



---

Verschiedenes  
Miscellaneous  
Diversos artículos  
Articles divers  
Articoli diversi

# 56

## Metallschalen, Messbecher

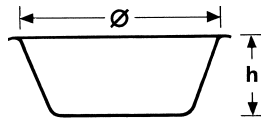
Stainless Steel Bowls, Measurers

Cubetas de acero inoxidable, Caso-medidas

Cuvettes de acier inoxydable, Mesures graduées

Scodelle di acciaio inossidabile, Bicchieri graduati

St  
18/8



|              | Ø x h          |            |
|--------------|----------------|------------|
| 56-170-16-01 | Ø 150 x 74 mm  | 750 ccm    |
| 56-170-17-01 | Ø 160 x 65 mm  | 1.000 ccm  |
| 56-170-22-01 | Ø 220 x 70 mm  | 2.000 ccm  |
| 56-170-24-01 | Ø 240 x 95 mm  | 3.000 ccm  |
| 56-170-27-01 | Ø 260 x 130 mm | 4.500 ccm  |
| 56-170-31-01 | Ø 300 x 105 mm | 6.000 ccm  |
| 56-170-34-01 | Ø 320 x 140 mm | 8.500 ccm  |
| 56-170-38-01 | Ø 380 x 125 mm | 11.000 ccm |
| 56-170-41-01 | Ø 400 x 150 mm | 14.000 ccm |



|              | Ø x h             |           |
|--------------|-------------------|-----------|
| 56-176-33-01 | Ø 330 mm x 90 mm  | 6.000 ccm |
| 56-178-33-01 | Ø 330 mm x 115 mm | 8.000 ccm |

## Metallschalen, Messbecher

Stainless Steel Bowls, Measurers

Cubetas de acero inoxidable, Caso-medidas

Cuvettes de acier inoxydable, Mesures graduées

Scodelle di acciaio inossidabile, Bicchieri graduati

## Verschiedenes

Miscellaneous

Diversos artículos

Articles divers

Articoli diversi



|              | Ø x h         |           |
|--------------|---------------|-----------|
| 56-231-04-01 | Ø 40 x 19 mm  | 20 ccm    |
| 56-231-06-01 | Ø 61 x 30 mm  | 70 ccm    |
| 56-231-08-01 | Ø 80 x 40 mm  | 140 ccm   |
| 56-231-11-01 | Ø 116 x 50 mm | 250 ccm   |
| 56-231-12-01 | Ø 128 x 55 mm | 350 ccm   |
| 56-231-14-01 | Ø 147 x 65 mm | 500 ccm   |
| 56-231-16-01 | Ø 167 x 75 mm | 900 ccm   |
| 56-231-18-01 | Ø 187 x 85 mm | 1.300 ccm |

|              | Ø x h         |         |
|--------------|---------------|---------|
| 56-235-11-01 | Ø 116 x 35 mm | 200 ccm |
| 56-235-12-01 | Ø 128 x 38 mm | 300 ccm |
| 56-235-14-01 | Ø 147 x 50 mm | 400 ccm |
| 56-235-16-01 | Ø 167 x 45 mm | 500 ccm |
| 56-235-18-01 | Ø 187 x 45 mm | 800 ccm |



innen graduert  
graduated inside  
graduado interiormente  
gradué intérieurement  
graduato all'interno

56-254-01-01 = 100 ccm



innen graduert  
graduated inside  
graduado interiormente  
gradué intérieurement  
graduato all'interno

56-256-02-01 = 250 ccm

56-256-05-01 = 500 ccm

56-256-10-01 = 1.000 ccm

56-256-20-01 = 2.000 ccm

## Mehrzweckschalen

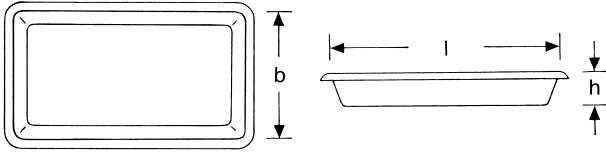
Universal Trays

Bandejas universales

Plateaux universaux

Bacinelle universali

St  
18/8



|              | l x b x h           |
|--------------|---------------------|
| 56-321-23-01 | = 230 x 155 x 30 mm |
| 56-321-30-01 | = 300 x 175 x 30 mm |
| 56-321-31-01 | = 300 x 175 x 40 mm |
| 56-321-35-01 | = 350 x 240 x 40 mm |
| 56-321-40-01 | = 470 x 320 x 50 mm |

|              | l x b x h           |
|--------------|---------------------|
| 56-324-21-01 | = 210 x 160 x 11 mm |
| 56-324-24-01 | = 240 x 180 x 9 mm  |
| 56-324-30-01 | = 300 x 160 x 11 mm |
| 56-324-31-01 | = 310 x 205 x 11 mm |
| 56-324-35-01 | = 335 x 235 x 10 mm |
| 56-324-40-01 | = 425 x 290 x 19 mm |
| 56-324-42-01 | = 400 x 300 x 12 mm |



|              | l x b x h           |
|--------------|---------------------|
| 56-340-23-01 | = 235 x 190 x 40 mm |



|              | Ø x h              |
|--------------|--------------------|
| 56-348-22-01 | = Ø 220 mm x 70 mm |

## Standgefäße, Instrumentenkästen

Metal Jars, Instrument Boxes

Tarros metálicos, Cajas para instrumentos

Réceptiens en métal, Boîtes pour instruments

Recipienti metallici, Scatole per strumenti

## Verschiedenes

Miscellaneous

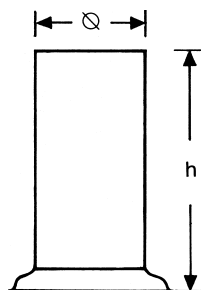
Diversos artículos

Articles divers

Articoli diversi

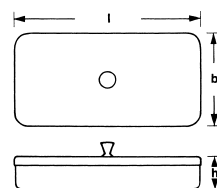


|              | Ø x h             |
|--------------|-------------------|
| 56-360-30-01 | = 30 mm x 90 mm   |
| 56-360-50-01 | = 50 mm x 100 mm  |
| 56-360-51-01 | = 50 mm x 130 mm  |
| 56-360-52-01 | = 50 mm x 175 mm  |
| 56-360-75-01 | = 75 mm x 100 mm  |
| 56-360-76-01 | = 75 mm x 130 mm  |
| 56-360-77-01 | = 75 mm x 175 mm  |
| 56-360-98-01 | = 100 mm x 175 mm |
| 56-360-99-01 | = 100 mm x 200 mm |



mit Knopfdeckel  
lid with knob  
tapa con botón  
avec couvercle à bouton  
con coperchio a bottone

|              | l x b x h           |
|--------------|---------------------|
| 56-411-16-01 | = 165 x 85 x 35 mm  |
| 56-411-20-01 | = 200 x 100 x 35 mm |
| 56-411-21-01 | = 200 x 100 x 50 mm |
| 56-411-23-01 | = 230 x 130 x 50 mm |
| 56-411-26-01 | = 260 x 150 x 50 mm |
| 56-411-27-01 | = 270 x 235 x 50 mm |
| 56-411-30-01 | = 300 x 200 x 50 mm |
| 56-411-33-01 | = 325 x 275 x 50 mm |



|              | l x b x h           |
|--------------|---------------------|
| 56-419-20-01 | = 205 x 105 x 40 mm |

54-73

## Standgefäße, Nierenschalen

Metal Jars, Kidney Dishes

Tarros metálicos, Riñoneras

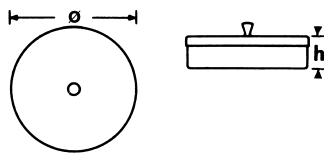
Réipients en métal, Bassins réniformes

Recipienti metallici, Bacinelle reniformi

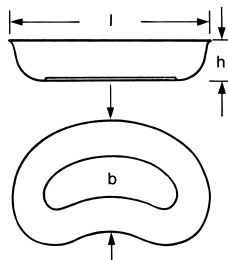
St  
18/8



|              | Ø x h             |
|--------------|-------------------|
| 56-431-06-01 | = 100 mm x 60 mm  |
| 56-431-10-01 | = 100 mm x 100 mm |
| 56-432-08-01 | = 125 mm x 80 mm  |
| 56-432-12-01 | = 125 mm x 125 mm |
| 56-435-15-01 | = 150 mm x 150 mm |



|              | l x b x h           |          |
|--------------|---------------------|----------|
| 56-673-17-01 | = 170 x 100 x 35 mm | 300 ccm  |
| 56-673-25-01 | = 250 x 140 x 40 mm | 800 ccm  |
| 56-673-27-01 | = 275 x 150 x 45 mm | 1200 ccm |



---

Verschiedenes  
Miscellaneous  
Diversos artículos  
Articles divers  
Articoli diversi

# 73

## Wasserstrahl-Reinigungspistole

Water Jet Pistol

Pistola-lavatoria de chorro de agua

Pistolet-laveur à jet d'eau

Pistola lavatrice a getto d'acqua



### Martin aquajet 73-101-00-04

komplett, mit 9 Aufsätzen 73-101-01-04 bis 73-101-09-04,  
1 m Druckschlauch, Haken und Schelle

complete, with 9 tips 73-101-01-04 to 73-101-09-04,  
1 m pressure tube, strap and suspension hook

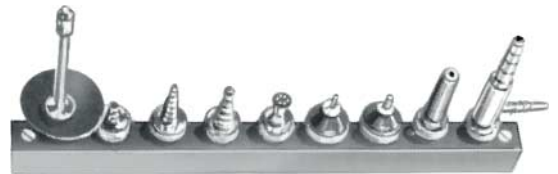
completo, con 9 toberas 73-101-01-04 a 73-101-09-04,  
1 m tubo de presión, abrazadera y gancho de  
suspensión

complet, avec 9 embouts 73-101-01-04 à 73-101-09-04,  
1 m de tuyau à haute pression, agrafe de serrage et  
crochet de suspension

completa, con 9 raccordi 73-101-01-04 sino 73-101-09-04  
1 m tubo ad alta pressione, graffa e gancio di sospensione

### Martin aquajet 73-101-20-04

allein  
only  
suelto  
seul  
solo



Aufsätze  
tips  
toberas  
embouts  
raccordi



S. 767



## Wasserstrahl-Reinigungspistole

Water Jet Pistol

Pistola-lavatoria de chorro de agua

Pistolet-laveur à jet d'eau

Pistola lavatrice a getto d'acqua

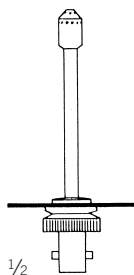
## Verschiedenes

Miscellaneous

Diversos artículos

Articles divers

Articoli diversi



73-101-01-04

**Fig. 1**

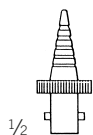
für Flaschen  
for bottles  
para botellas  
pour bouteilles  
per bottiglie



73-101-02-04

**Fig. 2**

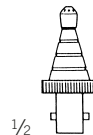
für Record-Spritzen Konen  
for cones of record-syringes  
para conos de jeringas  
Record  
pour raccords de seringues  
Record  
per coni di siringhe Record



73-101-03-04

**Fig. 3**

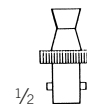
für Katheter  
for catheters  
para catéteres  
pour sondes  
per cateteri



73-101-04-04

**Fig. 4**

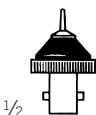
für Drainageschläuche  
for drainage tubings  
para tubos de drenaje  
pour sondes à drainage  
per tubi di drenaggio



73-101-05-04

**Fig. 5**

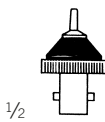
für Hohlgefäße  
for receptacles  
para recipientes  
pour vases  
per recipienti



73-101-06-04

**Fig. 6**

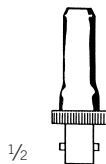
für Kanülen mit Record-Konus  
for hypodermic needles  
with Record-cone  
para agujas de inyección  
con cono Record  
pour aiguilles hypodér-  
miques, raccord Record  
per aghi ipodermici  
con cono Record



73-101-07-04

**Fig. 7**

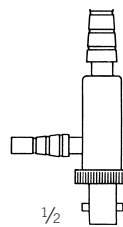
für Kanülen mit Luer-Konus  
for hypodermic needles  
with Luer-cone  
para agujas de inyección  
con cono Luer  
pour aiguilles hypodérmi-  
ques, raccord Luer  
per aghi ipodermici  
con cono Luer



73-101-08-04

**Fig. 8**

für Meß- und Vollpipetten  
for measuring and volume-  
tric pipettes  
para pipetas de medida  
y volumétricas  
pour pipettes ordinaires  
et de précision  
per pipette comuni  
e graduate



73-101-09-04

**Fig. 9**

für feine Pipetten  
for fine pipettes  
para pipetas finas  
pour pipettes fines  
per pipette fine



73-102-02-04

Überwurfmutter  
Coupling  
Tuerca-hembra  
Ecrou-raccord  
Dado premistoppa  
1/2 Zoll  
1/2 inch  
1/2 pulgada  
1/2 pouces  
1/2 pollici

73-102-03-04

3/4 Zoll  
3/4 inch  
3/4 pulgada  
3/4 pouces  
3/4 pollici

# Reinigungsbürsten

Cleaning Brushes  
Cepillos de limpieza  
Brosses à lavement  
Spazzole per pulire

**Nylonborsten**  
Nylon bristles  
Cerdas de nailon  
Poils nylon Scovolino in nylon

**Naturborsten**  
Natural bristles  
Cerdas naturales  
Poils naturels  
Scovolino naturale



|           |                 |                 |                 |                 |
|-----------|-----------------|-----------------|-----------------|-----------------|
|           | 73-301-03-04    | 73-303-03-04    | 73-304-07-04    | 73-306-08-04    |
| a x b x c | 250 x 70 x 3 mm | 425 x 70 x 3 mm | 285 x 75 x 7 mm | 270 x 65 x 8 mm |

**Naturborsten**  
Natural bristles  
Cerdas naturales  
Poils naturels  
Scovolino naturale



|                  |                  |                  |                  |                  |                  |
|------------------|------------------|------------------|------------------|------------------|------------------|
| 73-306-12-04     | 73-306-13-04     | 73-306-15-04     | 73-308-20-04     | 73-308-25-04     | 73-308-30-04     |
| 270 x 65 x 12 mm | 230 x 60 x 13 mm | 205 x 60 x 15 mm | 215 x 65 x 20 mm | 215 x 65 x 25 mm | 215 x 65 x 30 mm |

## Reinigungsbürsten

Cleaning Brushes  
Cepillos de limpieza  
Brosses à lavement  
Spazzole per pulire

## Verschiedenes

Miscellaneous  
Diversos artículos  
Articles divers  
Articoli diversi



### Naturborsten Natural bristles Cerdas naturales Poils naturels Scovolino naturale

210 x 60 x 13 mm

230 x 65 x 15 mm

230 x 95 x 20 mm

230 x 95 x 25 mm

215 x 95 x 28 mm

73-315-00-04

Satz mit 5 Bürsten  
set of 5 brushes  
juego de 5 cepillos  
jeu de 5 brosses  
set a 5 spazzole

### Naturborsten mit Wollfasern Natural bristles with wool fibers Cerdas naturales con fibras de lana Poils naturels avec fibres de laine Scovolino naturale con fibre di lana



73-318-12-04

275 x 75 x 12 mm

73-318-15-04

275 x 90 x 15 mm

73-318-30-04

320 x 150 x 30 mm

73-318-50-04

320 x 130 x 50 mm

54-  
73

## Reinigungsbürsten

Cleaning Brushes

Cepillos de limpieza

Brosses à lavement

Spazzole per pulire

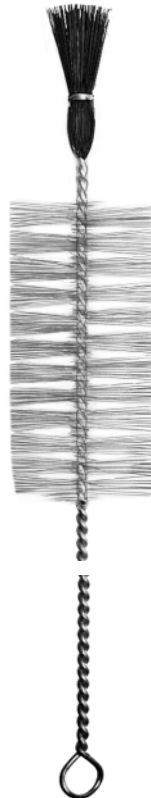
**Naturborsten**  
Natural bristles  
Cerdas naturales  
Poils naturels  
Scovolino naturale



73-324-35-04  
360 x 140 x 35 mm

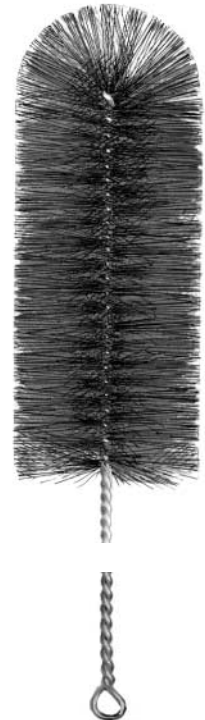


73-326-40-04  
440 x 180 x 40 mm



73-327-60-04  
510 x 135 x 60 mm

**Roßhaarborsten**  
Horsehair bristles  
Cerdas de crin de caballo  
Poils en crin  
Scovolino in crine di cavallo



73-333-80-04  
490 x 150 x 80 mm

**Naturborsten**  
Natural bristles  
Cerdas naturales  
Poils naturels  
Scovolino naturale



73-335-60-04  
490 x 160 x 60 mm



73-340-75-04  
420 x 130 x 75 mm



73-351-50-04  
330 x 130 x 50 mm

## Reinigungsbürsten

Cleaning Brushes  
Cepillos de limpieza  
Brosses à lavement  
Spazzole per pulire

## Verschiedenes

Miscellaneous  
Diversos artículos  
Articles divers  
Articoli diversi



**Naturborsten, konisch**  
**Natural bristles, conical**  
**Cerdas naturales, cónico**  
**Poils naturels, conique**  
**Scovolino naturale, conico**



73-356-15-04

410 x 190 x 8/20 mm

73-359-18-04

290 x 110 x 18/33 mm

73-361-15-04

315 x 85 x 15/25 mm

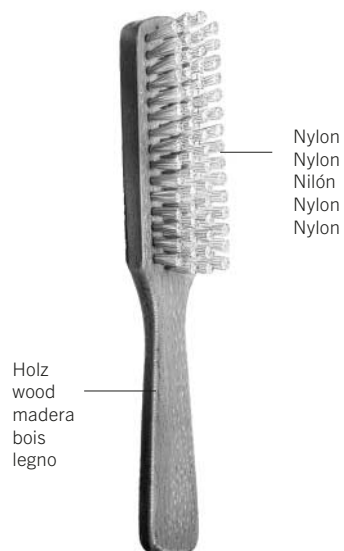
73-365-08-04

415 x 70 x 8/15 mm

73-367-16-04

1000 x 180 x 16 mm

54-  
73



73-370-95-04

210 x 95 mm

## Abfalleimer, Abfallzangen

Waste Bucket, Waste Forceps

Cobo para desechos, Pinzas para desechos

Seaux pour déchets, Pincés pour déchets

Secchi per rifiuti, Pinze per rifiuti

St  
18/8



73-454-15-01

**h = 325 mm Ø 305 mm**

Inhalt  
capacity  
capacidad  
capacité  
capacità  
**15 l**



Martin  
73-470-58-07  
58 cm / 22 7/8"



Sauerbruch  
73-474-55-07  
55 cm / 21 5/8"

---

Laserchirurgie  
Laser Surgery  
Cirugía láser  
Chirurgie laser  
Chirurgia laser

**76-79**

## Spezial-Produkte

Special Products  
Productos especiales  
Produits spéciaux  
Prodotti speciali

Informationen zu den KLS-Martin-Laser-Systemen entnehmen Sie bitte den separaten Broschüren:

- Diodengepumpter Nd:YAG-Laser Limax®
- Diodenlaser diomax®
- CO<sub>2</sub>-Laser MCO 25plus und MCO 50plus

Please refer to the separate brochures for information about KLS-Martin laser systems:

- Diode-pumped Nd:YAG Laser Limax®
- Diode laser diomax®
- CO<sub>2</sub> laser MCO 25plus and MCO 50plus

Encontrará información sobre los sistemas láser de KLS-Martin en los folletos específicos:

- Láser Nd:YAG bombeado por diodo Limax®
- Láser de diodo diomax®
- Láser CO<sub>2</sub> MCO 25plus y MCO 50plus

Veuillez vous reporter aux brochures séparées pour obtenir des informations détaillées à propos des systèmes de laser KLS Martin :

- Laser Nd:YAG Limax® pompé par diodes
- Laser à diodes diomax®
- Laser au CO<sub>2</sub> MCO 25plus et MCO 50plus

Per informazioni sui sistemi laser di KLS Martin, consultare le brochure separate:

- Laser Nd:YAG pompato a diodi Limax®
- Laser a diodi diomax®
- Laser CO<sub>2</sub> MCO 25plus e MCO 50plus





**MCO 25plus and MCO 50plus**  
All essential Parameters constantly in Focus

[www.klsmartin.com](http://www.klsmartin.com)



**diomax®**  
The "all-rounder" diode laser  
for advanced laser surgery

[www.klsmartin.com](http://www.klsmartin.com)



**Limax®**  
The diode-pumped Nd:YAG laser

[www.klsmartin.com](http://www.klsmartin.com)



---

Hochfrequenzchirurgie  
Electrosurgery  
Electrocirugía  
Électrochirurgicaux  
Elettrochirurgia

**80**

## Spezial-Produkte

Special Products  
Productos especiales  
Produits spéciaux  
Prodotti speciali

Informationen zu den KLS-Martin-Elektrochirurgie-Systemen entnehmen Sie bitte den separaten Katalogen bzw. Broschüren:

- Zubehör für die Hochfrequenzchirurgie
- Elektrochirurgiegerät maxium®
- smartOne – die Einmal-Zubehör-Linie
- marSeal5 plus Maryland – das System zur bipolaren Gefäßversiegelung

Please refer to the separate catalogs and brochures for information about KLS-Martin electro surgery systems:

- Accessories for Electrosurgery
- Electrosurgery device maxium®
- smartOne – the single-use HF accessory line
- marSeal5 plus Maryland – the bipolar vessel sealing system

Encontrará información sobre los sistemas de electrocirugía de KLS-Martin en los catálogos o folletos específicos:

- Accesorios para la electrocirugía
- Aparato de electrocirugía maxium®
- smartOne – la línea de accesorios desechables
- marSeal5 plus Maryland – el sistema para el sellado vascular bipolar

Veillez vous reporter aux catalogues ou brochures séparés pour obtenir des informations détaillées à propos des systèmes d'électrochirurgie KLS Martin:

- Accessoires électrochirurgicaux
- Dispositif d'électrochirurgie maxium®
- smartOne – la ligne d'accessoires à usage unique
- marSeal5 plus Maryland – le système de scellement de vaisseaux bipolaire

Per informazioni sui sistemi di elettrochirurgia di KLS Martin, consultare i cataloghi e/o le brochure separati:

- Accessori per elettrochirurgia
- Apparuccio elettrochirurgico maxium®
- smartOne – la linea di accessori monouso
- marSeal5 plus Maryland – il sistema per la sigillatura vascolare bipolare





---

Deckenversorgungseinheiten  
Ceiling-mounting systems  
Unidades de alimentación de techo  
Unités d'alimentation montées au plafond  
Sistemi pensili

# 85

## Spezial-Produkte

Special Products  
Productos especiales  
Produits spéciaux  
Prodotti speciali

---

Informationen zu den KLS-Martin-Deckenstativ-Systemen entnehmen Sie bitte den separaten Broschüren:

- independant
- independant Care
- independant Flex
- independant Fix

Please refer to the separate brochures for information about KLS-Martin ceiling mounting systems:

- independant
- independant Care
- independant Flex
- independant Fix

Veillez vous reporter aux brochures séparées pour obtenir des informations détaillées à propos des statifs de plafond KLS Martin:

- independant
- independant Care
- independant Flex
- independant Fix

Per informazioni sui sistemi pensili a soffitto di KLS Martin, consultare le brochure separate:

- independant
- independant Care
- independant Flex
- independant Fix

Encontrará información sobre los sistemas de soportes de techo de KLS-Martin en los folletos específicos:

- independant
- independant Care
- independant Flex
- independant Fix





**independant**

Ceiling supply solutions for operating theaters and intensive care units

[www.klsmartin.com](http://www.klsmartin.com)

**KLS martin**  
GROUP



**independant Care**  
Healthcare Design Technology

[www.klsmartin.com](http://www.klsmartin.com)

**KLS martin**  
GROUP



**independant Flex**  
Healthcare Design Technology

**KLS martin**  
GROUP



**independant Fix**  
Healthcare Design Technology

[www.klsmartin.com](http://www.klsmartin.com)



---

OP-Leuchten  
Operating Theatre Lights  
Lámparas de quirófano  
Lampes opératoires  
Lampade scialitiche

# 86-89

## Spezial-Produkte

Special Products  
Productos especiales  
Produits spéciaux  
Prodotti speciali

Informationen zu den KLS-Martin-Operations- und Untersuchungsleuchtenentnehmen Sie bitte den separaten Broschüren:

- Untersuchungsleuchten marLED® E1
- Untersuchungsleuchten marLED® E3
- Operationsleuchten marLED® E9i/E15
- Operationsleuchten marLED® X

Please refer to the separate brochures for information about KLS-Martin operating lights and examination lights:

- Examination lights marLED® E1
- Examination lights marLED® E3
- Operating lights marLED® E9i/E15
- Operating lights marLED® X

Encontrará información sobre las lámparas de quirófano y exploración de KLS-Martin en los folletos específicos:

- Lámparas de exploración marLED® E1
- Lámparas de exploración marLED® E3
- Lámparas de quirófano marLED® E9i/E15
- Operating lights marLED® X

Veillez vous reporter aux brochures séparées pour obtenir des informations détaillées relatives aux éclairages opératoires et d'examen KLS Martin :

- Éclairages d'examen marLED® E1
- Éclairages d'examen marLED® E3
- Éclairages opératoires marLED® E9i/E15
- Éclairages opératoires marLED® X

Per informazioni sulle lampade scialitiche e le lampade diagnostiche di KLS Martin, consultare le brochure separate:

- Lampade diagnostiche marLED® E1
- Lampade diagnostiche marLED® E3
- Lampade scialitiche marLED® E9i/E15
- Lampade scialitiche marLED® X





---

Nummern-Index  
Index of order numbers  
Índice de números de referencia  
Index numérique des références de commande  
Elenco dei codici



## Nummern-Index

Index of order numbers

Índice de números de referencia

Index numérique des références de commande

Elenco dei codici

### 10

|              |    |
|--------------|----|
| 10-002-01-07 | 2  |
| 10-002-02-07 | 2  |
| 10-002-03-07 | 2  |
| 10-002-04-07 | 2  |
| 10-002-05-07 | 2  |
| 10-002-06-07 | 2  |
| 10-002-07-07 | 2  |
| 10-002-08-07 | 2  |
| 10-002-09-07 | 2  |
| 10-002-10-07 | 2  |
| 10-038-16-07 | 3  |
| 10-038-20-07 | 3  |
| 10-038-24-07 | 3  |
| 10-090-09-07 | 4  |
| 10-092-11-07 | 4  |
| 10-094-13-07 | 4  |
| 10-100-04-07 | 5  |
| 10-100-34-07 | 5  |
| 10-104-41-07 | 5  |
| 10-104-45-07 | 5  |
| 10-109-09-07 | 6  |
| 10-112-04-07 | 6  |
| 10-118-03-07 | 6  |
| 10-120-04-07 | 6  |
| 10-130-03-07 | 6  |
| 10-130-04-07 | 6  |
| 10-130-05-07 | 6  |
| 10-133-31-07 | 7  |
| 10-133-35-07 | 7  |
| 10-135-01-07 | 7  |
| 10-137-07-07 | 8  |
| 10-137-71-07 | 8  |
| 10-140-03-07 | 8  |
| 10-142-03-07 | 8  |
| 10-146-03-07 | 8  |
| 10-147-03-07 | 8  |
| 10-148-03-07 | 8  |
| 10-155-10-04 | 9  |
| 10-155-11-04 | 9  |
| 10-155-12-04 | 9  |
| 10-155-15-04 | 9  |
| 10-155-18-04 | 9  |
| 10-155-20-04 | 9  |
| 10-155-21-04 | 9  |
| 10-155-22-04 | 9  |
| 10-155-23-04 | 9  |
| 10-155-24-04 | 9  |
| 10-155-36-04 | 9  |
| 10-156-12-04 | 9  |
| 10-156-15-04 | 9  |
| 10-160-01-07 | 10 |
| 10-295-10-04 | 12 |
| 10-295-11-04 | 12 |
| 10-295-12-04 | 12 |
| 10-295-15-04 | 12 |
| 10-296-12-04 | 12 |
| 10-296-15-04 | 12 |
| 10-500-19-07 | 13 |
| 10-560-06-07 | 13 |
| 10-878-00-07 | 14 |
| 10-878-01-07 | 14 |
| 10-880-00-07 | 14 |
| 10-880-01-07 | 14 |
| 10-880-02-07 | 14 |
| 10-882-19-07 | 14 |
| 10-882-90-98 | 14 |

### 11

|              |    |
|--------------|----|
| 11-100-11-07 | 16 |
| 11-100-13-07 | 16 |
| 11-100-14-07 | 16 |
| 11-100-16-07 | 16 |
| 11-100-18-07 | 16 |
| 11-100-20-07 | 16 |
| 11-102-11-07 | 17 |
| 11-102-13-07 | 17 |
| 11-102-14-07 | 17 |
| 11-102-16-07 | 17 |
| 11-102-18-07 | 17 |

|              |    |
|--------------|----|
| 11-102-20-07 | 17 |
| 11-104-11-07 | 18 |
| 11-104-13-07 | 18 |
| 11-104-14-07 | 18 |
| 11-104-16-07 | 18 |
| 11-105-11-07 | 19 |
| 11-105-13-07 | 19 |
| 11-105-14-07 | 19 |
| 11-105-16-07 | 19 |
| 11-105-18-07 | 19 |
| 11-105-20-07 | 19 |
| 11-107-11-07 | 20 |
| 11-107-13-07 | 20 |
| 11-107-14-07 | 20 |
| 11-107-16-07 | 20 |
| 11-107-18-07 | 20 |
| 11-107-20-07 | 20 |
| 11-109-11-07 | 21 |
| 11-109-13-07 | 21 |
| 11-109-14-07 | 21 |
| 11-109-16-07 | 21 |
| 11-110-01-07 | 22 |
| 11-110-02-07 | 22 |
| 11-110-03-07 | 22 |
| 11-110-04-07 | 22 |
| 11-120-14-07 | 22 |
| 11-122-14-07 | 22 |
| 11-124-14-07 | 22 |
| 11-125-14-07 | 23 |
| 11-127-14-07 | 23 |
| 11-129-14-07 | 23 |
| 11-136-14-07 | 23 |
| 11-140-14-07 | 23 |
| 11-141-14-07 | 23 |
| 11-170-14-07 | 24 |
| 11-170-17-07 | 24 |
| 11-170-23-07 | 24 |
| 11-171-14-07 | 25 |
| 11-171-17-07 | 25 |
| 11-171-23-07 | 25 |
| 11-174-22-07 | 29 |
| 11-175-22-07 | 29 |
| 11-175-30-07 | 29 |
| 11-180-15-07 | 26 |
| 11-180-17-07 | 26 |
| 11-181-15-07 | 27 |
| 11-181-17-07 | 27 |
| 11-184-16-07 | 28 |
| 11-184-19-07 | 28 |
| 11-184-21-07 | 28 |
| 11-185-16-07 | 28 |
| 11-185-19-07 | 28 |
| 11-185-21-07 | 28 |
| 11-190-17-07 | 29 |
| 11-191-17-07 | 29 |
| 11-200-20-07 | 30 |
| 11-200-23-07 | 30 |
| 11-203-20-07 | 31 |
| 11-203-23-07 | 31 |
| 11-226-16-07 | 32 |
| 11-227-16-07 | 33 |
| 11-230-17-07 | 34 |
| 11-231-17-07 | 34 |
| 11-232-24-07 | 35 |
| 11-233-24-07 | 35 |
| 11-235-20-07 | 36 |
| 11-235-23-07 | 36 |
| 11-248-11-07 | 37 |
| 11-249-11-07 | 38 |
| 11-250-14-07 | 37 |
| 11-252-14-07 | 40 |
| 11-254-14-07 | 40 |
| 11-255-14-07 | 38 |
| 11-257-14-07 | 40 |
| 11-259-14-07 | 40 |
| 11-264-15-07 | 40 |
| 11-265-15-07 | 40 |
| 11-280-18-07 | 41 |
| 11-280-20-07 | 41 |
| 11-280-23-07 | 41 |

|              |    |
|--------------|----|
| 11-280-25-07 | 41 |
| 11-280-28-07 | 41 |
| 11-280-30-07 | 41 |
| 11-284-18-07 | 40 |
| 11-284-20-07 | 40 |
| 11-285-18-07 | 42 |
| 11-285-20-07 | 42 |
| 11-285-23-07 | 42 |
| 11-285-25-07 | 42 |
| 11-285-28-07 | 42 |
| 11-285-30-07 | 42 |
| 11-298-14-07 | 44 |
| 11-299-14-07 | 44 |
| 11-300-15-07 | 44 |
| 11-301-15-07 | 44 |
| 11-302-15-07 | 44 |
| 11-305-00-07 | 44 |
| 11-306-12-07 | 45 |
| 11-306-19-07 | 45 |
| 11-307-19-07 | 45 |
| 11-308-17-07 | 45 |
| 11-310-16-07 | 46 |
| 11-311-16-07 | 47 |
| 11-314-18-07 | 49 |
| 11-314-21-07 | 49 |
| 11-314-24-07 | 49 |
| 11-316-17-07 | 49 |
| 11-316-20-07 | 49 |
| 11-317-11-07 | 50 |
| 11-317-14-07 | 50 |
| 11-319-19-07 | 50 |
| 11-320-10-07 | 51 |
| 11-321-10-07 | 51 |
| 11-324-16-07 | 52 |
| 11-325-16-07 | 52 |
| 11-326-14-07 | 53 |
| 11-327-14-07 | 54 |
| 11-328-14-07 | 56 |
| 11-329-14-07 | 57 |
| 11-329-18-07 | 57 |
| 11-329-20-07 | 57 |
| 11-330-18-07 | 53 |
| 11-330-20-07 | 53 |
| 11-330-23-07 | 53 |
| 11-331-18-07 | 54 |
| 11-331-20-07 | 54 |
| 11-331-23-07 | 54 |
| 11-335-18-07 | 58 |
| 11-335-20-07 | 58 |
| 11-335-23-07 | 58 |
| 11-339-12-07 | 59 |
| 11-339-18-07 | 59 |
| 11-340-14-07 | 59 |
| 11-341-14-07 | 59 |
| 11-344-11-07 | 59 |
| 11-345-11-07 | 59 |
| 11-350-14-07 | 60 |
| 11-351-14-07 | 61 |
| 11-352-14-07 | 62 |
| 11-353-14-07 | 62 |
| 11-354-14-07 | 63 |
| 11-355-14-07 | 63 |
| 11-357-12-07 | 64 |
| 11-358-13-07 | 64 |
| 11-359-12-07 | 65 |
| 11-359-15-07 | 65 |
| 11-359-18-07 | 65 |
| 11-359-20-07 | 65 |
| 11-362-14-07 | 66 |
| 11-363-14-07 | 66 |
| 11-364-14-07 | 67 |
| 11-364-15-07 | 67 |
| 11-364-18-07 | 67 |
| 11-365-14-07 | 68 |
| 11-365-15-07 | 68 |
| 11-365-18-07 | 68 |
| 11-367-14-07 | 69 |
| 11-369-14-07 | 69 |
| 11-370-01-07 | 70 |
| 11-370-02-07 | 70 |

|              |        |
|--------------|--------|
| 11-371-01-07 | 70     |
| 11-371-02-07 | 70     |
| 11-371-03-07 | 70     |
| 11-371-04-07 | 70     |
| 11-371-05-07 | 70     |
| 11-371-06-07 | 70     |
| 11-371-07-07 | 70     |
| 11-371-08-07 | 70     |
| 11-374-19-07 | 71     |
| 11-375-19-07 | 71     |
| 11-375-24-07 | 71     |
| 11-379-45-07 | 72     |
| 11-380-25-07 | 73     |
| 11-380-45-07 | 73     |
| 11-380-60-07 | 73     |
| 11-380-90-07 | 73     |
| 11-381-00-07 | 73     |
| 11-381-01-07 | 72     |
| 11-381-25-07 | 73     |
| 11-381-45-07 | 73     |
| 11-381-60-07 | 73     |
| 11-381-90-07 | 73     |
| 11-382-00-07 | 73     |
| 11-382-25-07 | 73     |
| 11-382-45-07 | 73     |
| 11-382-60-07 | 73     |
| 11-382-90-07 | 73     |
| 11-383-01-07 | 73     |
| 11-383-25-07 | 73     |
| 11-383-45-07 | 73     |
| 11-383-60-07 | 73     |
| 11-383-90-07 | 73     |
| 11-384-00-07 | 73     |
| 11-384-25-07 | 76     |
| 11-384-45-07 | 76     |
| 11-384-60-07 | 76     |
| 11-384-90-07 | 76     |
| 11-385-00-07 | 76     |
| 11-386-25-07 | 74     |
| 11-386-45-07 | 74     |
| 11-386-60-07 | 74     |
| 11-386-90-07 | 74     |
| 11-387-00-07 | 74     |
| 11-387-25-07 | 74     |
| 11-387-45-07 | 74     |
| 11-387-60-07 | 74     |
| 11-387-90-07 | 74     |
| 11-388-00-07 | 74     |
| 11-390-45-07 | 72     |
| 11-390-60-07 | 72     |
| 11-391-19-07 | 74     |
| 11-393-19-07 | 74     |
| 11-394-19-07 | 74     |
| 11-395-19-07 | 74     |
| 11-396-19-07 | 75     |
| 11-397-19-07 | 74     |
| 11-398-19-07 | 75     |
| 11-400-25-07 | 76     |
| 11-400-45-07 | 76     |
| 11-400-60-07 | 76     |
| 11-400-90-07 | 76     |
| 11-401-00-07 | 76     |
| 11-404-25-07 | 73, 74 |
| 11-407-00-07 | 73, 74 |
| 11-412-25-07 | 76     |
| 11-412-45-07 | 76     |
| 11-412-60-07 | 76     |
| 11-412-90-07 | 76     |
| 11-413-00-07 | 76     |
| 11-419-90-07 | 77     |
| 11-420-11-07 | 77     |
| 11-436-25-07 | 76     |
| 11-436-45-07 | 76     |
| 11-436-60-07 | 76     |
| 11-436-90-07 | 76     |
| 11-437-00-07 | 76     |
| 11-439-00-07 | 76     |
| 11-445-22-07 | 77     |
| 11-446-22-07 | 77     |
| 11-455-17-07 | 77     |

|              |     |
|--------------|-----|
| 11-459-17-07 | 78  |
| 11-475-23-07 | 79  |
| 11-495-17-07 | 80  |
| 11-497-17-07 | 82  |
| 11-499-19-07 | 81  |
| 11-503-15-07 | 83  |
| 11-505-16-07 | 85  |
| 11-507-15-07 | 84  |
| 11-509-16-07 | 85  |
| 11-510-20-07 | 87  |
| 11-511-18-07 | 86  |
| 11-513-18-07 | 87  |
| 11-517-11-07 | 88  |
| 11-519-11-07 | 88  |
| 11-531-18-07 | 89  |
| 11-535-14-07 | 89  |
| 11-537-22-07 | 89  |
| 11-545-10-07 | 90  |
| 11-547-16-07 | 90  |
| 11-551-16-07 | 90  |
| 11-553-16-07 | 90  |
| 11-566-13-07 | 91  |
| 11-567-13-07 | 91  |
| 11-570-12-07 | 92  |
| 11-571-12-07 | 92  |
| 11-582-12-07 | 92  |
| 11-584-12-07 | 92  |
| 11-587-12-07 | 92  |
| 11-589-12-07 | 92  |
| 11-593-11-07 | 93  |
| 11-594-11-07 | 93  |
| 11-595-11-07 | 93  |
| 11-605-16-07 | 94  |
| 11-607-16-07 | 94  |
| 11-618-08-07 | 95  |
| 11-619-08-07 | 95  |
| 11-620-09-07 | 95  |
| 11-620-10-07 | 95  |
| 11-621-09-07 | 95  |
| 11-621-10-07 | 95  |
| 11-622-10-07 | 95  |
| 11-624-09-07 | 96  |
| 11-625-09-07 | 96  |
| 11-630-11-07 | 97  |
| 11-631-11-07 | 98  |
| 11-633-11-07 | 96  |
| 11-635-11-07 | 99  |
| 11-640-12-07 | 96  |
| 11-641-12-07 | 96  |
| 11-644-13-07 | 100 |
| 11-645-13-07 | 100 |
| 11-650-14-07 | 17  |
| 11-651-14-07 | 20  |
| 11-652-14-07 | 24  |
| 11-652-17-07 | 24  |
| 11-652-23-07 | 24  |
| 11-653-14-07 | 25  |
| 11-653-17-07 | 25  |
| 11-653-23-07 | 25  |
| 11-654-15-07 | 26  |
| 11-654-17-07 | 26  |
| 11-655-15-07 | 27  |
| 11-655-17-07 | 27  |
| 11-656-16-07 | 32  |
| 11-657-16-07 | 33  |
| 11-658-11-07 | 37  |
| 11-658-14-07 | 37  |
| 11-659-11-07 | 38  |
| 11-659-14-07 | 38  |
| 11-660-18-07 | 41  |
| 11-660-20-07 | 41  |
| 11-660-23-07 | 41  |
| 11-660-26-07 | 41  |
| 11-660-28-07 | 41  |
| 11-660-31-07 | 41  |
| 11-661-18-07 | 42  |
| 11-661-20-07 | 42  |
| 11-661-23-07 | 42  |
| 11-661-26-07 | 42  |
| 11-661-28-07 | 42  |



## Nummern-Index

Index of order numbers

Índice de números de referencia

Index numérique des références de commande

Elenco dei codici

## Index

Index

Indice

Index

Indice



|              |     |              |     |              |     |              |     |              |     |
|--------------|-----|--------------|-----|--------------|-----|--------------|-----|--------------|-----|
| 11-661-31-07 | 42  | 11-887-30-07 | 43  | 11-961-18-07 | 54  | 12-131-17-07 | 127 | 12-287-18-07 | 136 |
| 11-662-10-07 | 51  | 11-889-14-07 | 55  | 11-961-20-07 | 54  | 12-132-19-07 | 127 | 12-287-20-07 | 136 |
| 11-662-16-07 | 46  | 11-889-18-07 | 55  | 11-961-23-07 | 54  | 12-134-20-07 | 127 | 12-287-20-09 | 136 |
| 11-663-10-07 | 51  | 11-893-17-07 | 78  | 11-961-25-07 | 54  | 12-135-13-07 | 128 | 12-288-24-09 | 136 |
| 11-663-16-07 | 47  | 11-895-16-07 | 48  | 11-961-28-07 | 54  | 12-135-15-07 | 128 | 12-301-10-07 | 137 |
| 11-665-14-07 | 54  | 11-902-14-07 | 16  | 11-962-18-07 | 56  | 12-135-17-07 | 128 | 12-301-11-07 | 137 |
| 11-665-18-07 | 54  | 11-903-14-07 | 19  | 11-962-20-07 | 56  | 12-135-20-07 | 128 | 12-301-13-07 | 137 |
| 11-665-20-07 | 54  | 11-904-14-07 | 17  | 11-962-23-07 | 56  | 12-166-12-07 | 128 | 12-301-14-07 | 137 |
| 11-665-23-07 | 54  | 11-905-14-07 | 20  | 11-965-14-07 | 117 | 12-168-12-07 | 128 | 12-301-16-07 | 137 |
| 11-666-14-07 | 60  | 11-906-14-07 | 18  | 11-965-17-07 | 78  | 12-168-15-07 | 128 | 12-301-18-07 | 137 |
| 11-667-14-07 | 61  | 11-907-14-07 | 21  | 11-965-20-07 | 117 | 12-170-15-07 | 128 | 12-301-20-07 | 137 |
| 11-669-12-07 | 65  | 11-910-14-07 | 24  | 11-965-23-07 | 117 | 12-171-20-07 | 128 | 12-301-23-07 | 137 |
| 11-669-15-07 | 65  | 11-910-17-07 | 24  | 11-967-18-07 | 58  | 12-172-12-07 | 129 | 12-301-25-07 | 137 |
| 11-670-18-07 | 65  | 11-910-23-07 | 24  | 11-967-20-07 | 58  | 12-172-15-07 | 129 | 12-301-30-07 | 137 |
| 11-671-15-07 | 68  | 11-911-14-07 | 25  | 11-967-23-07 | 58  | 12-174-17-07 | 129 | 12-302-11-07 | 137 |
| 11-671-18-07 | 68  | 11-911-17-07 | 25  | 11-968-11-07 | 117 | 12-180-17-07 | 129 | 12-302-13-07 | 137 |
| 11-672-10-07 | 97  | 11-911-23-07 | 25  | 11-969-11-07 | 117 | 12-183-17-07 | 129 | 12-302-14-07 | 137 |
| 11-672-11-07 | 97  | 11-914-14-07 | 111 | 11-969-17-07 | 118 | 12-184-06-07 | 129 | 12-302-16-07 | 137 |
| 11-673-10-07 | 98  | 11-914-18-07 | 111 | 11-969-19-07 | 118 | 12-184-08-07 | 129 | 12-302-18-07 | 137 |
| 11-673-11-07 | 98  | 11-914-20-07 | 111 | 11-969-23-07 | 118 | 12-184-10-07 | 129 | 12-302-20-07 | 137 |
| 11-674-10-07 | 102 | 11-914-23-07 | 111 | 11-970-19-07 | 119 | 12-184-18-07 | 130 | 12-302-25-07 | 137 |
| 11-675-10-07 | 102 | 11-914-25-07 | 111 | 11-970-23-07 | 119 | 12-186-18-07 | 130 | 12-303-14-07 | 138 |
| 11-676-10-07 | 101 | 11-914-30-07 | 111 | 11-971-19-07 | 119 | 12-187-18-07 | 130 | 12-303-16-07 | 138 |
| 11-677-10-07 | 101 | 11-915-14-07 | 112 | 11-971-23-07 | 119 | 12-188-17-07 | 130 | 12-303-20-07 | 138 |
| 11-678-10-07 | 101 | 11-915-17-07 | 112 | 11-973-17-07 | 119 | 12-189-17-07 | 130 | 12-304-14-07 | 138 |
| 11-679-10-07 | 101 | 11-915-23-07 | 112 | 11-975-20-07 | 31  | 12-192-18-07 | 130 | 12-304-16-07 | 138 |
| 11-680-11-07 | 102 | 11-916-14-07 | 113 | 11-975-23-07 | 31  | 12-192-21-07 | 130 | 12-321-13-07 | 138 |
| 11-681-11-07 | 102 | 11-916-18-07 | 113 | 11-976-23-07 | 30  | 12-192-25-07 | 130 | 12-321-14-07 | 138 |
| 11-682-11-07 | 101 | 11-916-20-07 | 113 | 11-977-23-07 | 31  | 12-192-30-07 | 130 | 12-321-16-07 | 138 |
| 11-683-11-07 | 101 | 11-917-11-07 | 39  | 11-979-22-07 | 120 | 12-230-17-07 | 131 | 12-321-18-07 | 138 |
| 11-690-11-07 | 103 | 11-917-18-07 | 43  | 11-979-23-07 | 121 | 12-234-17-07 | 131 | 12-321-20-07 | 138 |
| 11-691-11-07 | 103 | 11-917-20-07 | 43  | 11-980-13-07 | 91  | 12-236-15-07 | 131 | 12-321-23-07 | 138 |
| 11-705-11-07 | 103 | 11-917-23-07 | 43  | 11-981-13-07 | 91  | 12-238-15-07 | 131 | 12-321-25-07 | 138 |
| 11-710-15-07 | 104 | 11-917-25-07 | 43  | 11-982-11-07 | 97  | 12-240-16-07 | 131 | 12-321-30-07 | 138 |
| 11-710-18-07 | 104 | 11-917-30-07 | 43  | 11-983-11-07 | 98  | 12-240-18-07 | 131 | 12-323-15-07 | 139 |
| 11-710-19-07 | 104 | 11-919-14-07 | 113 | 11-985-25-07 | 122 | 12-242-16-07 | 131 | 12-326-13-07 | 139 |
| 11-711-15-07 | 104 | 11-919-18-07 | 113 | 11-985-45-07 | 122 | 12-242-18-07 | 131 | 12-326-14-07 | 139 |
| 11-711-18-07 | 104 | 11-921-17-07 | 78  | 11-985-60-07 | 122 | 12-244-12-07 | 132 | 12-331-15-07 | 139 |
| 11-711-19-07 | 104 | 11-923-16-07 | 48  | 11-987-25-07 | 122 | 12-246-12-07 | 132 | 12-332-15-07 | 139 |
| 11-711-20-07 | 104 | 11-925-20-07 | 31  | 11-987-45-07 | 122 | 12-246-15-07 | 132 | 12-366-15-07 | 139 |
| 11-712-15-07 | 104 | 11-925-23-07 | 31  | 11-987-60-07 | 122 | 12-250-12-07 | 132 | 12-366-20-07 | 139 |
| 11-712-18-07 | 104 | 11-930-15-07 | 26  | 11-989-11-07 | 99  | 12-250-15-07 | 132 | 12-367-15-07 | 139 |
| 11-712-19-07 | 104 | 11-930-17-07 | 26  | 11-989-22-07 | 120 | 12-252-12-07 | 132 | 12-367-20-07 | 139 |
| 11-713-15-07 | 104 | 11-931-15-07 | 27  | 11-989-23-07 | 121 | 12-252-15-07 | 132 | 12-367-25-07 | 139 |
| 11-713-18-07 | 104 | 11-931-17-07 | 27  | 11-991-12-07 | 123 | 12-254-17-07 | 133 | 12-368-12-07 | 140 |
| 11-713-19-07 | 104 | 11-934-12-07 | 114 | 11-991-15-07 | 123 | 12-255-18-07 | 133 | 12-368-15-07 | 140 |
| 11-713-20-07 | 104 | 11-935-12-07 | 114 | 11-991-18-07 | 123 | 12-256-18-07 | 133 | 12-370-15-07 | 140 |
| 11-740-11-07 | 103 | 11-936-11-07 | 37  | 11-992-16-07 | 32  | 12-258-14-07 | 133 | 12-371-20-07 | 140 |
| 11-741-11-07 | 103 | 11-937-11-07 | 38  | 11-993-16-07 | 33  | 12-258-15-07 | 133 | 12-371-25-07 | 140 |
| 11-758-12-07 | 105 | 11-938-14-07 | 37  | 11-994-17-07 | 82  | 12-258-18-07 | 133 | 12-372-12-07 | 140 |
| 11-760-09-07 | 105 | 11-939-14-07 | 38  | 11-995-12-07 | 109 | 12-258-20-07 | 133 | 12-372-15-07 | 140 |
| 11-761-09-07 | 105 | 11-942-18-07 | 41  | 11-996-16-07 | 124 | 12-258-23-07 | 133 | 12-374-17-07 | 141 |
| 11-765-18-07 | 105 | 11-942-20-07 | 41  | 11-997-16-07 | 94  | 12-258-25-07 | 133 | 12-380-17-07 | 141 |
| 11-767-18-07 | 105 | 11-942-23-07 | 41  | 11-999-16-07 | 94  | 12-260-14-07 | 134 | 12-383-17-07 | 141 |
| 11-769-18-07 | 105 | 11-942-25-07 | 41  |              |     | 12-260-16-07 | 134 | 12-384-06-07 | 141 |
| 11-782-21-07 | 106 | 11-942-28-07 | 41  |              |     | 12-260-18-07 | 134 | 12-384-08-07 | 141 |
| 11-784-09-07 | 107 | 11-942-30-07 | 41  |              |     | 12-260-20-07 | 134 | 12-384-10-07 | 141 |
| 11-784-21-07 | 106 | 11-943-18-07 | 42  | 12-100-10-07 | 126 | 12-260-25-07 | 134 | 12-386-17-07 | 142 |
| 11-785-32-07 | 106 | 11-943-20-07 | 42  | 12-100-11-07 | 126 | 12-266-15-07 | 134 | 12-387-17-07 | 142 |
| 11-801-10-07 | 107 | 11-943-23-07 | 42  | 12-100-13-07 | 126 | 12-266-23-07 | 134 | 12-388-17-07 | 142 |
| 11-809-11-07 | 107 | 11-943-25-07 | 42  | 12-100-14-07 | 126 | 12-267-20-07 | 134 | 12-392-18-07 | 142 |
| 11-819-13-07 | 107 | 11-943-28-07 | 42  | 12-100-16-07 | 126 | 12-270-15-07 | 135 | 12-392-21-07 | 142 |
| 11-821-09-07 | 107 | 11-943-30-07 | 42  | 12-100-18-07 | 126 | 12-272-15-07 | 135 | 12-392-25-07 | 142 |
| 11-824-09-07 | 108 | 11-945-20-07 | 115 | 12-100-20-07 | 126 | 12-272-19-07 | 135 | 12-392-30-07 | 142 |
| 11-824-10-07 | 108 | 11-945-23-07 | 115 | 12-100-23-07 | 126 | 12-272-24-07 | 135 | 12-400-12-07 | 142 |
| 11-826-13-07 | 108 | 11-945-28-07 | 115 | 12-100-25-07 | 126 | 12-274-24-07 | 135 | 12-402-12-07 | 143 |
| 11-830-14-07 | 108 | 11-948-14-07 | 60  | 12-100-30-07 | 126 | 12-276-18-07 | 135 | 12-403-12-07 | 143 |
| 11-830-18-07 | 108 | 11-948-14-07 | 60  | 12-120-11-07 | 126 | 12-276-18-07 | 135 | 12-404-12-07 | 143 |
| 11-834-14-07 | 108 | 11-949-14-07 | 61  | 12-120-13-07 | 126 | 12-278-18-07 | 135 | 12-404-15-07 | 143 |
| 11-840-12-07 | 108 | 11-950-10-07 | 115 | 12-120-14-07 | 126 | 12-279-18-07 | 135 | 12-406-12-07 | 143 |
| 11-865-12-07 | 109 | 11-950-16-07 | 46  | 12-120-16-07 | 126 | 12-280-16-09 | 136 | 12-406-15-07 | 143 |
| 11-874-10-07 | 110 | 11-950-21-07 | 46  | 12-120-18-07 | 126 | 12-282-16-09 | 136 | 12-408-11-07 | 143 |
| 11-875-10-07 | 110 | 11-951-10-07 | 115 | 12-120-20-07 | 126 | 12-282-20-09 | 136 | 12-409-12-07 | 144 |
| 11-878-12-07 | 110 | 11-951-16-07 | 47  | 12-120-23-07 | 126 | 12-282-24-09 | 136 | 12-410-12-07 | 144 |
| 11-879-12-07 | 110 | 11-951-21-07 | 47  | 12-120-25-07 | 126 | 12-284-16-09 | 136 | 12-412-11-07 | 144 |
| 11-887-11-07 | 39  | 11-953-16-07 | 116 | 12-120-30-07 | 126 | 12-284-20-09 | 136 | 12-414-11-07 | 144 |
| 11-887-18-07 | 43  | 11-954-14-07 | 53  | 12-122-13-07 | 127 | 12-285-18-07 | 136 | 12-416-11-07 | 144 |
| 11-887-20-07 | 43  | 11-955-14-07 | 54  | 12-123-15-07 | 127 | 12-285-20-07 | 136 | 12-418-11-07 | 144 |
| 11-887-23-07 | 43  | 11-956-14-07 | 56  | 12-126-13-07 | 127 | 12-286-18-07 | 136 | 12-420-15-07 | 145 |
| 11-887-25-07 | 43  | 11-957-14-07 | 57  | 12-126-14-07 | 127 | 12-286-20-07 | 136 | 12-420-20-07 | 145 |
|              |     | 11-960-18-07 | 53  | 12-130-15-07 | 127 |              |     |              |     |

## Nummern-Index

Index of order numbers

Índice de números de referencia

Index numérique des références de commande

Elenco dei codici

|              |     |              |     |              |     |              |     |              |     |
|--------------|-----|--------------|-----|--------------|-----|--------------|-----|--------------|-----|
| 12-420-25-07 | 145 | 12-576-15-07 | 151 | 13-051-14-07 | 158 | 13-145-40-09 | 166 | 13-355-14-07 | 176 |
| 12-426-14-07 | 145 | 12-576-18-07 | 151 | 13-052-04-07 | 158 | 13-145-50-09 | 166 | 13-357-14-07 | 176 |
| 12-426-16-07 | 145 | 12-576-21-07 | 151 | 13-052-05-07 | 158 | 13-176-14-07 | 167 | 13-363-18-07 | 177 |
| 12-426-20-07 | 145 | 12-578-15-09 | 152 | 13-053-05-07 | 158 | 13-176-16-07 | 167 | 13-363-19-07 | 177 |
| 12-426-25-07 | 145 | 12-578-18-09 | 152 | 13-054-05-07 | 159 | 13-248-13-07 | 167 | 13-364-18-07 | 177 |
| 12-444-18-07 | 145 | 12-579-15-09 | 152 | 13-055-05-07 | 159 | 13-248-14-07 | 167 | 13-365-18-07 | 177 |
| 12-451-18-07 | 146 | 12-579-18-09 | 152 | 13-056-03-07 | 159 | 13-248-15-07 | 167 | 13-369-20-07 | 177 |
| 12-456-23-07 | 146 | 12-580-15-09 | 152 | 13-058-05-07 | 159 | 13-248-18-07 | 167 | 13-370-16-07 | 177 |
| 12-460-18-07 | 146 | 12-580-18-09 | 152 | 13-059-05-07 | 159 | 13-248-20-07 | 167 | 13-370-20-07 | 177 |
| 12-460-23-07 | 146 | 12-580-21-09 | 152 | 13-062-00-07 | 160 | 13-249-13-07 | 167 | 13-371-16-07 | 177 |
| 12-466-23-07 | 147 | 12-581-15-09 | 152 | 13-062-01-07 | 160 | 13-249-14-07 | 167 | 13-371-20-07 | 177 |
| 12-467-23-07 | 147 | 12-581-18-09 | 152 | 13-062-02-07 | 160 | 13-249-15-07 | 167 | 13-374-13-07 | 178 |
| 12-468-18-07 | 147 | 12-581-21-09 | 152 | 13-102-04-07 | 161 | 13-249-18-07 | 167 | 13-374-14-07 | 178 |
| 12-502-10-07 | 148 | 12-582-15-09 | 151 | 13-102-06-07 | 161 | 13-249-20-07 | 167 | 13-374-16-07 | 178 |
| 12-503-10-07 | 148 | 12-582-18-09 | 151 | 13-102-08-07 | 161 | 13-256-13-07 | 168 | 13-375-13-07 | 178 |
| 12-505-10-07 | 148 | 12-583-15-09 | 151 | 13-102-10-07 | 161 | 13-258-13-07 | 168 | 13-375-14-07 | 178 |
| 12-512-10-07 | 148 | 12-583-18-09 | 151 | 13-104-14-07 | 161 | 13-266-25-07 | 168 | 13-375-16-07 | 178 |
| 12-513-10-07 | 148 | 12-585-21-09 | 151 | 13-106-18-07 | 161 | 13-266-26-07 | 168 | 13-380-14-07 | 178 |
| 12-515-10-07 | 148 | 12-586-15-09 | 151 | 13-108-10-07 | 162 | 13-268-14-07 | 169 | 13-380-16-07 | 178 |
| 12-552-01-07 | 149 | 12-586-18-09 | 151 | 13-108-14-07 | 162 | 13-278-17-07 | 169 | 13-380-18-07 | 178 |
| 12-552-02-07 | 149 | 12-586-21-09 | 151 | 13-108-18-07 | 162 | 13-280-15-07 | 169 | 13-381-14-07 | 178 |
| 12-552-03-07 | 149 | 12-588-15-09 | 151 | 13-109-10-07 | 162 | 13-280-20-07 | 169 | 13-381-16-07 | 178 |
| 12-552-04-07 | 149 | 12-588-18-09 | 151 | 13-109-14-07 | 162 | 13-290-14-07 | 170 | 13-381-18-07 | 178 |
| 12-552-05-07 | 149 | 12-588-21-09 | 151 | 13-109-18-07 | 162 | 13-303-01-07 | 170 | 13-382-14-07 | 179 |
| 12-552-06-07 | 149 | 12-589-15-07 | 151 | 13-110-06-07 | 162 | 13-303-02-07 | 170 | 13-382-16-07 | 179 |
| 12-552-07-07 | 149 | 12-589-18-07 | 151 | 13-111-06-07 | 162 | 13-304-14-07 | 170 | 13-382-18-07 | 179 |
| 12-552-08-07 | 149 | 12-589-21-07 | 151 | 13-114-03-07 | 162 | 13-305-18-07 | 170 | 13-383-14-07 | 179 |
| 12-552-09-07 | 149 | 12-590-15-09 | 151 | 13-114-05-07 | 162 | 13-306-10-07 | 171 | 13-383-16-07 | 179 |
| 12-552-10-07 | 149 | 12-590-18-09 | 151 | 13-115-03-07 | 162 | 13-307-10-07 | 171 | 13-383-18-07 | 179 |
| 12-552-11-07 | 149 | 12-590-21-09 | 151 | 13-115-05-07 | 162 | 13-309-12-07 | 171 | 13-384-13-07 | 179 |
| 12-552-12-07 | 149 | 12-591-00-07 | 152 | 13-115-38-07 | 163 | 13-310-12-07 | 171 | 13-384-14-07 | 179 |
| 12-553-01-07 | 149 | 12-591-01-07 | 152 | 13-115-45-07 | 163 | 13-310-14-07 | 171 | 13-384-16-07 | 179 |
| 12-553-05-07 | 149 | 12-591-02-07 | 152 | 13-115-55-07 | 163 | 13-310-62-09 | 172 | 13-385-13-07 | 179 |
| 12-553-06-07 | 149 | 12-591-03-07 | 152 | 13-115-65-07 | 163 | 13-311-12-07 | 171 | 13-385-14-07 | 179 |
| 12-553-07-07 | 149 | 12-591-04-07 | 152 | 13-115-75-07 | 163 | 13-311-14-07 | 171 | 13-385-16-07 | 179 |
| 12-553-08-07 | 149 | 12-591-05-07 | 152 | 13-115-90-07 | 163 | 13-311-62-09 | 172 | 13-390-20-07 | 180 |
| 12-553-09-07 | 149 | 12-592-00-07 | 152 | 13-116-38-07 | 163 | 13-312-14-07 | 171 | 13-390-26-07 | 180 |
| 12-560-00-07 | 150 | 12-592-01-07 | 152 | 13-116-45-07 | 163 | 13-312-62-09 | 172 | 13-391-20-07 | 180 |
| 12-560-02-07 | 150 | 12-592-02-07 | 152 | 13-116-55-07 | 163 | 13-313-12-07 | 171 | 13-391-26-07 | 180 |
| 12-560-03-07 | 150 | 12-592-03-07 | 152 | 13-116-65-07 | 163 | 13-313-14-07 | 171 | 13-392-20-07 | 180 |
| 12-560-05-07 | 150 | 12-592-04-07 | 152 | 13-116-75-07 | 163 | 13-313-62-09 | 172 | 13-392-26-07 | 180 |
| 12-560-45-07 | 150 | 12-592-05-07 | 152 | 13-116-90-07 | 163 | 13-316-18-07 | 172 | 13-393-20-07 | 180 |
| 12-561-00-07 | 150 | 12-600-12-07 | 153 | 13-120-08-07 | 164 | 13-316-21-07 | 172 | 13-393-26-07 | 180 |
| 12-561-02-07 | 150 | 12-601-12-07 | 153 | 13-120-10-07 | 164 | 13-317-18-07 | 172 | 13-410-14-07 | 181 |
| 12-561-03-07 | 150 | 12-604-09-07 | 153 | 13-120-12-07 | 164 | 13-317-21-07 | 172 | 13-410-16-07 | 181 |
| 12-561-05-07 | 150 | 12-604-11-07 | 153 | 13-121-08-07 | 164 | 13-318-18-07 | 172 | 13-410-18-07 | 181 |
| 12-561-45-07 | 150 | 12-604-12-07 | 153 | 13-121-10-07 | 164 | 13-318-21-07 | 172 | 13-410-20-07 | 181 |
| 12-562-00-07 | 150 | 12-605-09-07 | 153 | 13-121-12-07 | 164 | 13-319-18-07 | 172 | 13-410-22-07 | 181 |
| 12-562-01-07 | 150 | 12-605-12-07 | 153 | 13-122-10-07 | 164 | 13-319-21-07 | 172 | 13-410-24-07 | 181 |
| 12-562-02-07 | 150 | 12-624-12-07 | 154 | 13-122-14-07 | 164 | 13-320-10-07 | 173 | 13-410-26-07 | 181 |
| 12-562-03-07 | 150 | 12-630-07-07 | 154 | 13-122-20-07 | 164 | 13-320-12-07 | 173 | 13-410-30-07 | 181 |
| 12-562-04-07 | 150 | 12-630-09-07 | 154 | 13-123-10-07 | 164 | 13-321-10-07 | 173 | 13-411-14-07 | 182 |
| 12-562-05-07 | 150 | 12-630-11-07 | 154 | 13-123-14-07 | 164 | 13-321-12-07 | 173 | 13-411-16-07 | 182 |
| 12-563-00-07 | 150 | 12-640-10-07 | 154 | 13-123-20-07 | 164 | 13-322-10-07 | 173 | 13-411-18-07 | 182 |
| 12-563-01-07 | 150 | 12-641-10-07 | 154 | 13-125-10-07 | 164 | 13-322-12-07 | 173 | 13-411-20-07 | 182 |
| 12-563-02-07 | 150 | 12-664-08-07 | 155 | 13-125-14-07 | 164 | 13-323-10-07 | 173 | 13-411-22-07 | 182 |
| 12-563-03-07 | 150 | 12-666-09-07 | 155 | 13-125-20-07 | 164 | 13-323-12-07 | 173 | 13-411-24-07 | 182 |
| 12-563-04-07 | 150 | 12-674-09-07 | 155 | 13-131-24-07 | 166 | 13-324-14-07 | 173 | 13-411-26-07 | 182 |
| 12-563-05-07 | 150 | 12-676-09-07 | 155 | 13-132-30-09 | 165 | 13-325-14-07 | 173 | 13-411-30-07 | 182 |
| 12-564-15-07 | 152 | 12-680-09-07 | 155 | 13-132-35-09 | 165 | 13-326-15-07 | 173 | 13-414-14-07 | 183 |
| 12-564-18-07 | 152 | 12-695-10-07 | 155 | 13-132-40-09 | 165 | 13-327-15-07 | 173 | 13-414-16-07 | 183 |
| 12-565-15-07 | 152 | 12-720-13-07 | 156 | 13-132-50-09 | 165 | 13-328-15-07 | 173 | 13-414-18-07 | 183 |
| 12-565-18-07 | 152 | 12-721-13-07 | 156 | 13-133-30-09 | 165 | 13-329-15-07 | 173 | 13-414-22-07 | 183 |
| 12-566-15-07 | 152 | 12-725-11-07 | 156 | 13-133-35-09 | 165 | 13-330-14-07 | 174 | 13-414-24-07 | 183 |
| 12-566-18-07 | 152 | 12-774-15-07 | 151 | 13-133-40-09 | 165 | 13-331-14-07 | 174 | 13-414-26-07 | 183 |
| 12-566-21-07 | 152 | 12-774-18-07 | 151 | 13-133-50-09 | 165 | 13-331-64-09 | 174 | 13-414-30-07 | 183 |
| 12-567-15-07 | 152 | 12-774-21-07 | 151 | 13-135-30-09 | 166 | 13-332-12-07 | 174 | 13-415-14-07 | 184 |
| 12-567-18-07 | 152 | 12-776-15-07 | 151 | 13-135-35-09 | 166 | 13-333-19-07 | 174 | 13-415-16-07 | 184 |
| 12-567-21-07 | 152 | 12-776-18-07 | 151 | 13-135-40-09 | 166 | 13-334-16-07 | 175 | 13-415-18-07 | 184 |
| 12-568-15-07 | 151 | 12-776-21-07 | 151 | 13-135-50-09 | 166 | 13-335-16-07 | 175 | 13-415-20-07 | 184 |
| 12-568-18-07 | 151 | 12-786-15-09 | 151 | 13-142-30-09 | 165 | 13-339-14-07 | 175 | 13-415-22-07 | 184 |
| 12-569-15-07 | 151 | 12-786-18-09 | 151 | 13-142-35-09 | 165 | 13-340-14-07 | 175 | 13-415-24-07 | 184 |
| 12-569-18-07 | 151 | 12-786-21-09 | 151 | 13-142-40-09 | 165 | 13-341-14-07 | 175 | 13-415-26-07 | 184 |
| 12-570-15-07 | 151 | 12-787-15-09 | 151 | 13-142-50-09 | 165 | 13-342-14-07 | 175 | 13-415-30-07 | 184 |
| 12-570-18-07 | 151 | 12-787-18-09 | 151 | 13-143-30-09 | 165 | 13-343-14-07 | 175 | 13-417-01-07 | 185 |
| 12-571-15-07 | 151 | 12-787-21-09 | 151 | 13-143-35-09 | 165 | 13-346-16-07 | 176 | 13-417-02-07 | 185 |
| 12-571-18-07 | 151 | 12-776-21-07 | 151 | 13-143-40-09 | 165 | 13-347-16-07 | 176 | 13-417-03-07 | 185 |
| 12-574-15-07 | 151 | 12-776-21-07 | 151 | 13-143-50-09 | 165 | 13-348-15-07 | 176 | 13-417-04-07 | 185 |
| 12-574-18-07 | 151 | 13-010-00-07 | 158 | 13-145-30-09 | 166 | 13-350-15-07 | 176 | 13-417-05-07 | 185 |
| 12-574-21-07 | 151 | 13-050-14-07 | 158 | 13-145-35-09 | 166 | 13-351-12-07 | 176 | 13-419-18-07 | 186 |

## Nummern-Index

Index of order numbers

Índice de números de referencia

Index numérique des références de commande

Elenco dei codici

## Index

Index

Indice

Index

Indice

|              |     |              |     |              |     |              |     |              |     |
|--------------|-----|--------------|-----|--------------|-----|--------------|-----|--------------|-----|
| 13-421-14-07 | 186 | 13-531-22-07 | 200 | 14-101-22-07 | 218 | 15-151-04-07 | 230 | 15-242-06-07 | 239 |
| 13-421-18-07 | 186 | 13-531-24-07 | 200 | 14-101-27-07 | 218 | 15-151-05-07 | 230 | 15-242-08-07 | 239 |
| 13-422-20-07 | 186 | 13-533-23-07 | 200 | 14-110-13-07 | 219 | 15-151-06-07 | 230 | 15-251-03-07 | 240 |
| 13-423-20-07 | 186 | 13-571-21-07 | 201 | 14-110-16-07 | 219 | 15-161-01-07 | 231 | 15-253-04-07 | 240 |
| 13-425-20-07 | 186 | 13-577-19-07 | 202 | 14-110-18-07 | 219 | 15-161-02-07 | 231 | 15-261-02-07 | 241 |
| 13-427-21-07 | 186 | 13-577-22-07 | 202 | 14-115-13-07 | 219 | 15-164-14-07 | 231 | 15-266-08-07 | 241 |
| 13-428-22-07 | 187 | 13-577-24-07 | 202 | 14-120-17-07 | 219 | 15-166-16-07 | 231 | 15-267-08-07 | 241 |
| 13-429-22-07 | 187 | 13-579-19-07 | 202 | 14-222-20-07 | 220 | 15-167-16-07 | 231 | 15-281-04-07 | 242 |
| 13-432-24-07 | 187 | 13-579-22-07 | 202 | 14-222-22-07 | 220 | 15-170-20-07 | 231 | 15-283-05-07 | 242 |
| 13-433-24-07 | 187 | 13-579-24-07 | 202 | 14-222-27-07 | 220 | 15-171-08-07 | 232 | 15-287-06-07 | 242 |
| 13-439-18-07 | 188 | 13-581-19-07 | 202 | 14-223-20-07 | 220 | 15-171-10-07 | 232 | 15-289-07-07 | 242 |
| 13-439-24-07 | 188 | 13-581-22-07 | 202 | 14-223-22-07 | 220 | 15-171-12-07 | 232 | 15-291-01-07 | 243 |
| 13-443-01-07 | 189 | 13-581-24-07 | 202 | 14-223-27-07 | 220 | 15-171-14-07 | 232 | 15-291-02-07 | 243 |
| 13-443-02-07 | 189 | 13-583-28-07 | 203 | 14-231-40-07 | 220 | 15-171-16-07 | 232 | 15-291-03-07 | 243 |
| 13-443-03-07 | 189 | 13-585-28-07 | 203 | 14-286-25-07 | 221 | 15-171-18-07 | 232 | 15-291-04-07 | 243 |
| 13-443-04-07 | 189 | 13-595-19-07 | 203 | 14-290-25-07 | 221 | 15-172-08-07 | 232 | 15-291-05-07 | 243 |
| 13-443-05-07 | 189 | 13-597-19-07 | 203 | 14-313-26-07 | 221 | 15-172-10-07 | 232 | 15-293-01-07 | 243 |
| 13-443-06-07 | 189 | 13-600-21-07 | 204 | 14-320-24-07 | 222 | 15-172-12-07 | 232 | 15-293-02-07 | 243 |
| 13-443-07-07 | 189 | 13-601-21-07 | 204 | 14-350-25-07 | 222 | 15-172-14-07 | 232 | 15-293-03-07 | 243 |
| 13-447-01-07 | 189 | 13-613-19-07 | 204 | 14-352-18-07 | 222 | 15-172-16-07 | 232 | 15-293-04-07 | 243 |
| 13-447-02-07 | 189 | 13-613-21-07 | 204 | 14-352-20-07 | 222 | 15-172-18-07 | 232 | 15-293-05-07 | 243 |
| 13-447-03-07 | 189 | 13-613-23-07 | 204 | 14-352-25-07 | 222 | 15-174-04-07 | 233 | 15-295-21-07 | 244 |
| 13-447-04-07 | 189 | 13-615-19-07 | 204 | 14-353-25-07 | 222 | 15-174-06-07 | 233 | 15-297-21-07 | 244 |
| 13-447-05-07 | 189 | 13-615-21-07 | 204 | 14-355-18-07 | 222 | 15-174-08-07 | 233 | 15-299-01-07 | 245 |
| 13-447-06-07 | 189 | 13-615-23-07 | 204 | 14-355-20-07 | 222 | 15-174-11-07 | 233 | 15-301-16-07 | 245 |
| 13-447-07-07 | 189 | 13-625-21-07 | 205 | 14-355-25-07 | 222 | 15-174-15-07 | 233 | 15-301-25-07 | 245 |
| 13-448-00-07 | 190 | 13-635-10-07 | 206 | 14-360-25-07 | 223 | 15-174-17-07 | 233 | 15-307-19-07 | 246 |
| 13-448-01-07 | 190 | 13-635-20-07 | 206 | 14-361-25-07 | 223 | 15-174-20-07 | 233 | 15-313-20-07 | 246 |
| 13-448-02-07 | 190 | 13-635-30-07 | 206 | 14-370-18-07 | 223 | 15-174-23-07 | 233 | 15-315-18-07 | 247 |
| 13-448-03-07 | 190 | 13-635-40-07 | 206 | 14-370-25-07 | 223 | 15-176-01-07 | 234 | 15-315-20-07 | 247 |
| 13-448-06-07 | 190 | 13-637-10-07 | 206 |              |     | 15-176-02-07 | 234 | 15-315-25-07 | 247 |
| 13-449-00-07 | 191 | 13-637-20-07 | 206 |              |     | 15-191-01-07 | 234 | 15-315-30-07 | 247 |
| 13-449-01-07 | 191 | 13-637-30-07 | 206 |              |     | 15-191-02-07 | 234 | 15-315-40-07 | 247 |
| 13-449-06-07 | 191 | 13-637-35-07 | 206 |              |     | 15-195-01-07 | 235 | 15-317-01-07 | 248 |
| 13-450-01-07 | 191 | 13-671-23-07 | 207 |              |     | 15-195-02-07 | 235 | 15-317-02-07 | 248 |
| 13-450-02-07 | 191 | 13-673-24-07 | 207 |              |     | 15-195-03-07 | 235 | 15-317-03-07 | 248 |
| 13-451-13-07 | 192 | 13-697-25-07 | 208 |              |     | 15-200-04-07 | 235 | 15-317-04-07 | 248 |
| 13-451-16-07 | 192 | 13-717-22-07 | 208 |              |     | 15-201-04-07 | 235 | 15-317-05-07 | 248 |
| 13-451-18-07 | 192 | 13-719-23-07 | 208 |              |     | 15-210-01-07 | 236 | 15-317-06-07 | 248 |
| 13-451-20-07 | 192 | 13-721-14-07 | 209 |              |     | 15-210-02-07 | 236 | 15-317-07-07 | 248 |
| 13-451-23-07 | 192 | 13-725-18-07 | 209 |              |     | 15-210-03-07 | 236 | 15-317-08-07 | 248 |
| 13-451-25-07 | 192 | 13-727-20-07 | 209 |              |     | 15-210-04-07 | 236 | 15-317-09-07 | 248 |
| 13-451-28-07 | 192 | 13-745-20-07 | 210 |              |     | 15-210-06-07 | 236 | 15-319-01-07 | 249 |
| 13-453-18-07 | 192 | 13-749-21-07 | 210 |              |     | 15-211-01-07 | 236 | 15-319-02-07 | 249 |
| 13-453-22-07 | 192 | 13-751-20-07 | 210 |              |     | 15-211-02-07 | 236 | 15-319-03-07 | 249 |
| 13-453-25-07 | 192 | 13-753-20-07 | 210 |              |     | 15-211-03-07 | 236 | 15-319-04-07 | 249 |
| 13-453-28-07 | 192 | 13-875-09-07 | 211 |              |     | 15-211-04-07 | 236 | 15-319-05-07 | 249 |
| 13-461-01-07 | 193 | 13-881-05-07 | 211 |              |     | 15-211-06-07 | 236 | 15-319-06-07 | 249 |
| 13-461-02-07 | 193 | 13-881-09-07 | 211 |              |     | 15-220-01-07 | 237 | 15-319-07-07 | 249 |
| 13-461-03-07 | 193 | 13-909-11-07 | 211 |              |     | 15-220-02-07 | 237 | 15-319-08-07 | 249 |
| 13-461-04-07 | 193 | 13-909-13-07 | 211 |              |     | 15-220-03-07 | 237 | 15-321-00-07 | 250 |
| 13-461-05-07 | 193 | 13-915-08-07 | 211 |              |     | 15-220-04-07 | 237 | 15-321-01-07 | 250 |
| 13-469-01-07 | 194 | 13-915-11-07 | 211 |              |     | 15-220-06-07 | 237 | 15-321-02-07 | 250 |
| 13-469-02-07 | 194 | 13-915-13-07 | 211 |              |     | 15-221-01-07 | 237 | 15-321-03-07 | 250 |
| 13-471-14-07 | 194 | 13-915-15-07 | 211 |              |     | 15-221-02-07 | 237 | 15-321-05-07 | 250 |
| 13-473-15-07 | 195 | 13-916-15-07 | 212 |              |     | 15-221-03-07 | 237 | 15-325-01-07 | 251 |
| 13-473-19-07 | 195 | 13-917-13-07 | 212 |              |     | 15-221-04-07 | 237 | 15-325-02-07 | 251 |
| 13-479-14-07 | 195 | 13-919-10-07 | 212 |              |     | 15-221-06-07 | 237 | 15-351-01-07 | 251 |
| 13-479-17-07 | 195 | 13-919-13-07 | 212 |              |     | 15-222-01-07 | 237 | 15-351-02-07 | 251 |
| 13-479-19-07 | 195 | 13-921-16-07 | 212 |              |     | 15-222-02-07 | 237 | 15-351-03-07 | 251 |
| 13-479-20-07 | 195 | 13-923-10-07 | 212 |              |     | 15-222-03-07 | 237 | 15-361-01-07 | 252 |
| 13-479-23-07 | 195 | 13-923-13-07 | 212 |              |     | 15-222-04-07 | 237 | 15-361-02-07 | 252 |
| 13-479-26-07 | 195 | 13-923-14-07 | 213 |              |     | 15-222-06-07 | 237 | 15-361-03-07 | 252 |
| 13-483-22-07 | 196 | 13-924-11-07 | 213 |              |     | 15-230-01-07 | 238 | 15-381-01-01 | 252 |
| 13-485-23-07 | 196 | 13-924-14-07 | 213 |              |     | 15-231-01-07 | 238 | 15-381-02-01 | 252 |
| 13-487-21-07 | 196 | 13-935-20-07 | 213 |              |     | 15-232-01-07 | 238 | 15-391-01-01 | 253 |
| 13-487-24-07 | 196 | 13-940-14-07 | 213 |              |     | 15-240-01-07 | 239 | 15-391-02-01 | 253 |
| 13-491-22-07 | 197 | 13-942-16-07 | 213 |              |     | 15-240-02-07 | 239 | 15-391-03-01 | 253 |
| 13-493-25-07 | 197 | 13-944-15-07 | 214 |              |     | 15-240-03-07 | 239 | 15-395-24-01 | 253 |
| 13-495-28-07 | 197 | 13-944-18-07 | 214 |              |     | 15-240-04-07 | 239 | 15-397-26-01 | 253 |
| 13-497-22-07 | 197 | 13-944-20-07 | 214 |              |     | 15-240-06-07 | 239 | 15-401-01-07 | 254 |
| 13-501-18-07 | 198 | 13-946-15-07 | 214 |              |     | 15-241-01-07 | 239 | 15-401-02-07 | 254 |
| 13-511-19-07 | 198 | 13-946-18-07 | 214 |              |     | 15-241-02-07 | 239 | 15-401-03-07 | 254 |
| 13-513-23-07 | 198 | 13-946-20-07 | 214 |              |     | 15-241-03-07 | 239 | 15-405-01-07 | 255 |
| 13-521-24-07 | 198 | 13-948-01-04 | 215 |              |     | 15-241-04-07 | 239 | 15-405-02-07 | 255 |
| 13-527-01-07 | 199 | 13-948-02-07 | 215 |              |     | 15-241-06-07 | 239 | 15-405-03-07 | 255 |
| 13-527-02-07 | 199 |              |     |              |     | 15-242-01-07 | 239 | 15-405-04-07 | 255 |
| 13-529-23-07 | 199 |              |     |              |     | 15-242-02-07 | 239 | 15-405-05-07 | 255 |
| 13-529-24-07 | 199 |              |     |              |     | 15-242-03-07 | 239 | 15-405-06-07 | 255 |
| 13-531-20-07 | 200 |              |     |              |     | 15-242-04-07 | 239 | 15-441-01-07 | 256 |

## 14

|              |     |
|--------------|-----|
| 14-100-22-07 | 218 |
| 14-100-27-07 | 218 |

# Nummern-Index

Index of order numbers

Índice de números de referencia

Index numérique des références de commande

Elenco dei codici

|                       |                       |                            |                            |                       |
|-----------------------|-----------------------|----------------------------|----------------------------|-----------------------|
| 15-441-02-07 .....256 | 15-623-40-07 .....275 | 15-771-20-07 .....294      | 15-860-08-07 .....315      | 15-921-44-07 .....335 |
| 15-441-03-07 .....256 | 15-652-01-01 .....276 | 15-771-26-07 .....294      | 15-868-00-01 .....316      | 15-921-50-07 .....336 |
| 15-452-00-07 .....257 | 15-655-00-01 .....276 | 15-772-26-07 .....294      | 15-868-90-98 .....316      | 15-921-51-07 .....336 |
| 15-452-01-07 .....257 | 15-655-01-01 .....276 | 15-773-13-07 .....295      | 15-868-91-98 .....316      | 15-921-52-07 .....336 |
| 15-452-02-07 .....257 | 15-655-02-01 .....276 | 15-774-00-07 .....296      | 15-882-00-07 .....317      | 15-921-60-07 .....336 |
| 15-452-03-07 .....257 | 15-655-03-01 .....276 | 15-774-25-07 .....296      | 15-882-30-07 .....317      | 15-921-70-07 .....337 |
| 15-452-04-07 .....257 | 15-663-00-07 .....277 | 15-774-40-07 .....296      | 15-884-00-07 .....318      | 15-921-71-07 .....337 |
| 15-452-05-07 .....257 | 15-665-00-07 .....277 | 15-774-45-07 .....296      | 15-884-24-07 .....318, 319 | 15-921-72-07 .....337 |
| 15-461-25-01 .....258 | 15-667-06-01 .....277 | 15-774-50-07 .....296      | 15-889-40-07 .....318, 319 | 15-921-80-07 .....337 |
| 15-469-22-07 .....258 | 15-669-13-01 .....277 | 15-774-55-07 .....296      | 15-889-50-07 .....317,     | 15-921-90-07 .....338 |
| 15-471-01-07 .....258 | 15-673-01-07 .....278 | 15-774-60-07 .....296      | 15-889-60-07 .....318, 319 | 15-921-91-07 .....338 |
| 15-471-02-07 .....258 | 15-673-02-07 .....278 | 15-775-00-07 .....296, 297 | 15-889-78-07 .....319      | 15-922-01-07 .....338 |
| 15-471-03-07 .....258 | 15-675-00-07 .....278 | 15-775-15-07 .....296, 297 | 15-889-80-07 .....319      | 15-922-10-07 .....339 |
| 15-501-25-07 .....259 | 15-683-00-07 .....279 | 15-775-40-07 .....297      | 15-889-98-07 .....317, 319 | 15-922-11-07 .....339 |
| 15-505-28-07 .....259 | 15-687-00-07 .....279 | 15-775-45-07 .....297      | 15-889-99-07 .....317, 319 | 15-922-15-07 .....339 |
| 15-507-28-07 .....259 | 15-695-00-01 .....279 | 15-775-50-07 .....297      | 15-906-00-07 .....320      | 15-922-20-07 .....339 |
| 15-537-01-07 .....260 | 15-700-05-07 .....280 | 15-775-55-07 .....297      | 15-906-01-07 .....321      | 15-922-30-07 .....340 |
| 15-537-02-07 .....260 | 15-701-05-07 .....280 | 15-775-60-07 .....297      | 15-906-02-07 .....321      | 15-922-31-07 .....340 |
| 15-537-03-07 .....260 | 15-702-07-07 .....280 | 15-776-31-07 .....298      | 15-906-06-07 .....321      | 15-922-32-07 .....340 |
| 15-545-01-07 .....261 | 15-703-07-07 .....280 | 15-777-32-07 .....298      | 15-906-07-07 .....321      | 15-922-33-07 .....340 |
| 15-545-02-07 .....261 | 15-704-07-07 .....280 | 15-778-00-07 .....299      | 15-906-11-07 .....321      | 15-922-34-07 .....340 |
| 15-558-08-07 .....262 | 15-705-07-07 .....280 | 15-778-01-07 .....299      | 15-906-12-07 .....321      | 15-922-35-07 .....340 |
| 15-558-10-07 .....262 | 15-714-07-07 .....281 | 15-778-02-07 .....299      | 15-906-13-07 .....321      | 15-922-36-07 .....340 |
| 15-558-12-07 .....262 | 15-714-10-07 .....281 | 15-778-03-07 .....299      | 15-906-41-07 .....321      | 15-922-40-07 .....341 |
| 15-558-13-07 .....262 | 15-715-07-07 .....281 | 15-778-32-07 .....300      | 15-906-42-07 .....321      | 15-922-41-07 .....341 |
| 15-558-14-07 .....262 | 15-715-10-07 .....281 | 15-790-01-07 .....301      | 15-906-43-07 .....321      | 15-922-50-07 .....342 |
| 15-558-16-07 .....262 | 15-717-10-07 .....280 | 15-790-02-07 .....301      | 15-906-44-07 .....321      | 15-922-51-07 .....342 |
| 15-558-18-07 .....262 | 15-723-10-07 .....281 | 15-792-01-01 .....302      | 15-906-46-07 .....321      | 15-922-60-07 .....343 |
| 15-559-08-07 .....263 | 15-723-20-07 .....281 | 15-792-02-01 .....302      | 15-906-47-07 .....321      | 15-922-61-07 .....343 |
| 15-559-10-07 .....263 | 15-725-14-07 .....282 | 15-793-00-01 .....302      | 15-906-50-07 .....320      | 15-922-70-07 .....344 |
| 15-559-12-07 .....263 | 15-727-14-07 .....282 | 15-794-00-01 .....302      | 15-910-01-07 .....322      | 15-922-71-07 .....344 |
| 15-559-14-07 .....263 | 15-732-20-07 .....282 | 15-794-90-98 .....302      | 15-910-50-07 .....322, 323 | 15-922-80-07 .....344 |
| 15-559-16-07 .....263 | 15-733-21-07 .....283 | 15-798-01-01 .....302      | 15-917-00-07 .....323      | 15-922-81-07 .....344 |
| 15-559-18-07 .....263 | 15-733-22-07 .....283 | 15-801-00-07 .....303      | 15-917-01-07 .....323      | 15-922-82-07 .....344 |
| 15-561-01-07 .....264 | 15-734-20-07 .....284 | 15-802-13-07 .....303      | 15-917-02-07 .....323      | 15-922-90-07 .....345 |
| 15-561-02-07 .....264 | 15-734-24-07 .....284 | 15-802-18-07 .....303      | 15-917-03-07 .....323      | 15-922-91-07 .....345 |
| 15-561-03-07 .....264 | 15-734-26-07 .....284 | 15-804-18-07 .....303      | 15-917-04-07 .....323      | 15-922-95-07 .....345 |
| 15-563-01-07 .....265 | 15-735-20-07 .....284 | 15-820-00-07 .....304,     | 15-917-10-07 .....323      | 15-922-96-07 .....345 |
| 15-563-02-07 .....265 | 15-735-24-07 .....284 | 15-820-00-07 .....307, 308 | 15-917-12-07 .....323      | 15-963-01-01 .....348 |
| 15-563-03-07 .....265 | 15-735-26-07 .....284 | 15-822-22-07 .....304      | 15-917-15-07 .....323      | 15-963-02-01 .....348 |
| 15-563-04-07 .....265 | 15-736-26-07 .....285 | 15-823-00-07 .....305      | 15-920-10-07 .....326      | 15-963-03-01 .....348 |
| 15-563-05-07 .....265 | 15-737-26-07 .....285 | 15-823-90-98 .....305      | 15-920-11-07 .....326      | 15-971-00-01 .....348 |
| 15-563-06-07 .....265 | 15-738-25-07 .....286 | 15-824-00-07 .....305      | 15-920-20-07 .....327      | 15-971-01-01 .....348 |
| 15-564-01-07 .....266 | 15-738-26-07 .....285 | 15-824-90-98 .....305      | 15-920-21-07 .....327      | 15-971-02-01 .....348 |
| 15-564-02-07 .....266 | 15-739-25-07 .....286 | 15-826-00-07 .....306      | 15-920-22-07 .....327      | 15-975-06-01 .....348 |
| 15-564-03-07 .....266 | 15-739-26-07 .....285 | 15-826-90-98 .....306      | 15-920-23-07 .....327      | 15-975-09-01 .....348 |
| 15-564-04-07 .....266 | 15-740-13-07 .....287 | 15-828-00-07 .....307      | 15-920-24-07 .....327      | 15-975-13-01 .....348 |
| 15-564-05-07 .....266 | 15-741-13-07 .....287 | 15-828-01-07 .....307      | 15-920-29-07 .....328      | 15-975-16-01 .....348 |
| 15-564-06-07 .....266 | 15-748-10-07 .....287 | 15-830-00-07 .....307      | 15-920-30-07 .....328      | 15-975-19-01 .....348 |
| 15-581-01-07 .....267 | 15-749-10-07 .....287 | 15-830-02-07 .....307      | 15-920-31-07 .....328      | 15-975-25-01 .....348 |
| 15-581-02-07 .....267 | 15-750-13-07 .....288 | 15-830-04-07 .....307      | 15-920-32-07 .....329      | 15-975-25-01 .....348 |
| 15-591-00-07 .....268 | 15-750-16-07 .....288 | 15-839-18-07 .....304, 308 | 15-920-33-07 .....328      |                       |
| 15-591-01-07 .....268 | 15-751-13-07 .....288 | 15-839-27-07 .....304, 308 | 15-920-34-07 .....328, 329 |                       |
| 15-591-02-07 .....268 | 15-751-16-07 .....288 | 15-839-38-07 .....304,     | 15-920-35-07 .....329      |                       |
| 15-591-03-07 .....268 | 15-752-13-07 .....289 | 15-839-45-07 .....305, 308 | 15-920-40-07 .....329      |                       |
| 15-591-04-07 .....268 | 15-753-13-07 .....289 | 15-839-50-07 .....309      | 15-920-42-07 .....329      |                       |
| 15-591-05-07 .....268 | 15-754-15-07 .....289 | 15-839-52-07 .....309      | 15-920-43-07 .....329      |                       |
| 15-591-06-07 .....268 | 15-755-13-07 .....290 | 15-839-60-07 .....306, 308 | 15-920-44-07 .....329      |                       |
| 15-591-07-07 .....269 | 15-756-13-07 .....290 | 15-839-70-07 .....309      | 15-920-45-07 .....329      |                       |
| 15-591-08-07 .....269 | 15-757-11-07 .....290 | 15-839-90-07 .....307, 309 | 15-920-50-07 .....330      |                       |
| 15-591-09-07 .....269 | 15-759-11-07 .....290 | 15-839-92-07 .....307, 309 | 15-920-51-07 .....330      |                       |
| 15-592-04-07 .....270 | 15-761-05-07 .....291 | 15-839-94-07 .....309      | 15-920-60-04 .....330      |                       |
| 15-592-07-07 .....270 | 15-761-06-07 .....291 | 15-840-00-07 .....310      | 15-920-90-07 .....330      |                       |
| 15-592-08-07 .....270 | 15-761-07-07 .....291 | 15-844-00-07 .....310      | 15-921-01-07 .....331      |                       |
| 15-592-10-07 .....270 | 15-762-05-07 .....291 | 15-844-91-98 .....310      | 15-921-02-07 .....331      |                       |
| 15-593-01-01 .....271 | 15-762-06-07 .....291 | 15-846-00-07 .....311      | 15-921-03-07 .....331      |                       |
| 15-593-02-01 .....271 | 15-762-07-07 .....291 | 15-850-00-07 .....311      | 15-921-10-07 .....332      |                       |
| 15-593-03-01 .....271 | 15-765-13-07 .....292 | 15-852-00-07 .....312      | 15-921-12-07 .....332      |                       |
| 15-603-01-07 .....272 | 15-767-13-07 .....292 | 15-854-00-07 .....312      | 15-921-13-07 .....332      |                       |
| 15-603-02-07 .....272 | 15-768-00-07 .....293 | 15-856-00-07 .....313      | 15-921-20-07 .....333      |                       |
| 15-603-03-07 .....272 | 15-768-19-07 .....293 | 15-856-90-98 .....313      | 15-921-21-07 .....333      |                       |
| 15-607-26-07 .....273 | 15-768-25-07 .....293 | 15-856-91-98 .....313      | 15-921-22-07 .....333      |                       |
| 15-611-01-07 .....273 | 15-768-32-07 .....293 | 15-858-00-07 .....314      | 15-921-30-07 .....334      |                       |
| 15-611-02-07 .....273 | 15-769-00-07 .....293 | 15-859-01-07 .....312, 314 | 15-921-31-07 .....334      |                       |
| 15-615-01-01 .....274 | 15-770-13-07 .....294 | 15-859-02-07 .....314, 315 | 15-921-32-07 .....334      |                       |
| 15-615-02-01 .....274 | 15-770-16-07 .....294 | 15-859-06-07 .....314      | 15-921-33-07 .....334      |                       |
| 15-615-03-01 .....274 | 15-770-20-07 .....294 | 15-860-00-07 .....315      | 15-921-40-07 .....335      |                       |
| 15-621-28-07 .....275 | 15-770-26-07 .....294 | 15-860-06-07 .....315      | 15-921-41-07 .....335      |                       |
| 15-623-20-07 .....275 | 15-771-13-07 .....294 |                            | 15-921-42-07 .....335      |                       |
| 15-623-30-07 .....275 | 15-771-16-07 .....294 |                            | 15-921-43-07 .....335      |                       |

|                       |  |
|-----------------------|--|
| <b>16</b>             |  |
| 16-100-11-01 .....350 |  |
| 16-100-13-01 .....350 |  |
| 16-100-14-01 .....350 |  |
| 16-100-16-01 .....350 |  |
| 16-100-18-01 .....350 |  |
| 16-100-20-01 .....350 |  |
| 16-100-25-01 .....350 |  |
| 16-100-30-01 .....350 |  |
| 16-102-11-01 .....350 |  |
| 16-102-13-01 .....350 |  |
| 16-102-14-01 .....350 |  |
| 16-102-16-01 .....350 |  |
| 16-102-18-01 .....350 |  |
| 16-102-20-01 .....350 |  |
| 16-103-13-01 .....350 |  |
| 16-103-14-01 .....350 |  |
| 16-103-16-01 .....350 |  |
| 16-103-18-01 .....350 |  |
| 16-103-20-01 .....350 |  |
| 16-103-25-01 .....350 |  |
| 16-108-13-01 .....350 |  |
| 16-108-14-01 .....350 |  |
| 16-108-16-01 .....350 |  |
| 16-130-10-07 .....350 |  |
| 16-150-13-07 .....350 |  |
| 16-150-14-07 .....350 |  |
| 16-150-16-07 .....350 |  |

## Nummern-Index

Index of order numbers

Índice de números de referencia

Index numérique des références de commande

Elenco dei codici

## Index

Index

Indice

Index

Indice



|                    |     |                    |     |                    |          |                    |           |                    |     |
|--------------------|-----|--------------------|-----|--------------------|----------|--------------------|-----------|--------------------|-----|
| 16-150-18-07 ..... | 350 | 18-524-72-01 ..... | 366 | 18-579-23-01 ..... | 378      | 19-352-00-07 ..... | 389       | 20-013-23-07 ..... | 404 |
| 16-150-20-07 ..... | 350 | 18-524-73-01 ..... | 366 | 18-580-08-07 ..... | 379      | 19-353-00-07 ..... | 389       | 20-016-15-09 ..... | 404 |
| 16-160-13-01 ..... | 351 | 18-524-74-01 ..... | 366 | 18-580-10-07 ..... | 379      | 19-353-01-07 ..... | 389       | 20-016-18-09 ..... | 404 |
| 16-160-14-01 ..... | 351 | 18-524-75-01 ..... | 366 | 18-580-12-07 ..... | 379      | 19-353-02-07 ..... | 389       | 20-017-15-09 ..... | 404 |
| 16-160-16-01 ..... | 351 | 18-524-80-01 ..... | 366 | 18-580-14-07 ..... | 379      | 19-353-03-07 ..... | 389       | 20-017-18-09 ..... | 404 |
| 16-170-13-01 ..... | 351 | 18-524-81-01 ..... | 366 | 18-580-16-07 ..... | 379      | 19-353-04-07 ..... | 389       | 20-018-15-09 ..... | 404 |
| 16-170-14-01 ..... | 351 | 18-524-82-01 ..... | 366 | 18-581-08-07 ..... | 379      | 19-360-00-07 ..... | 390       | 20-018-18-09 ..... | 404 |
| 16-170-16-01 ..... | 351 | 18-524-83-01 ..... | 366 | 18-581-10-07 ..... | 379      | 19-361-00-07 ..... | 390       | 20-019-15-09 ..... | 404 |
| 16-175-14-01 ..... | 351 | 18-524-84-01 ..... | 366 | 18-581-12-07 ..... | 379      | 19-363-01-07 ..... | 390       | 20-019-18-09 ..... | 404 |
| 16-185-16-01 ..... | 351 | 18-524-85-01 ..... | 366 | 18-581-14-07 ..... | 379      | 19-363-02-07 ..... | 390       | 20-020-15-09 ..... | 404 |
| 16-249-01-07 ..... | 352 | 18-525-06-01 ..... | 367 | 18-581-16-07 ..... | 379      | 19-363-03-07 ..... | 390       | 20-020-18-09 ..... | 404 |
| 16-249-02-07 ..... | 352 | 18-525-08-01 ..... | 367 | 18-583-08-07 ..... | 380      | 19-363-04-07 ..... | 390       | 20-020-21-09 ..... | 404 |
| 16-249-03-07 ..... | 352 | 18-525-10-01 ..... | 367 | 18-583-10-07 ..... | 380      | 19-380-00-07 ..... | 391       | 20-020-23-09 ..... | 404 |
| 16-249-04-07 ..... | 352 | 18-525-12-01 ..... | 367 | 18-583-12-07 ..... | 380      | 19-383-00-07 ..... | 391       | 20-021-15-09 ..... | 404 |
| 16-249-05-07 ..... | 352 | 18-526-00-01 ..... | 368 | 18-583-14-07 ..... | 380      | 19-383-01-07 ..... | 391       | 20-021-18-09 ..... | 404 |
| 16-249-06-07 ..... | 352 | 18-526-17-01 ..... | 368 | 18-583-16-07 ..... | 380      | 19-383-02-07 ..... | 391       | 20-021-21-09 ..... | 404 |
| 16-250-00-01 ..... | 353 | 18-526-05-01 ..... | 368 | 18-584-08-07 ..... | 380      | 19-383-03-07 ..... | 391       | 20-021-23-09 ..... | 404 |
| 16-250-02-04 ..... | 353 | 18-526-07-01 ..... | 368 | 18-584-10-07 ..... | 380      | 19-383-04-07 ..... | 391       | 20-022-15-09 ..... | 404 |
| 16-250-03-07 ..... | 353 | 18-526-09-01 ..... | 368 | 18-584-12-07 ..... | 380      | 19-384-00-07 ..... | 391       | 20-022-18-09 ..... | 404 |
| 16-250-06-07 ..... | 353 | 18-526-12-01 ..... | 368 | 18-584-14-07 ..... | 380      | 19-387-01-07 ..... | 392, 393  | 20-022-21-09 ..... | 404 |
| 16-250-09-07 ..... | 353 | 18-527-00-01 ..... | 368 | 18-584-16-07 ..... | 380      | 19-387-02-07 ..... | 392       | 20-022-23-09 ..... | 404 |
| 16-250-12-07 ..... | 353 | 18-527-01-01 ..... | 368 | 18-606-00-01 ..... | 381      | 19-387-03-07 ..... | 392       | 20-023-15-09 ..... | 404 |
| 16-250-15-07 ..... | 353 | 18-527-04-01 ..... | 368 | 18-606-01-01 ..... | 381      | 19-387-04-07 ..... | 392, 393  | 20-023-18-09 ..... | 404 |
| 16-250-80-07 ..... | 353 | 18-527-06-01 ..... | 368 | 18-610-12-07 ..... | 381      | 19-390-00-07 ..... | 392       | 20-023-21-09 ..... | 404 |
| 16-250-90-07 ..... | 353 | 18-527-08-01 ..... | 368 | 18-610-15-07 ..... | 381      | 19-391-00-07 ..... | 392       | 20-023-23-09 ..... | 404 |
| 16-251-02-01 ..... | 354 | 18-528-10-01 ..... | 369 | 18-611-20-07 ..... | 381      | 19-392-00-02 ..... | 393       | 20-030-15-07 ..... | 405 |
| 16-251-03-01 ..... | 354 | 18-528-15-01 ..... | 369 | 18-611-30-07 ..... | 381      | 19-395-00-04 ..... | 393       | 20-030-15-09 ..... | 405 |
| 16-251-04-01 ..... | 354 | 18-528-20-01 ..... | 369 | 18-611-37-07 ..... | 381      | 19-395-01-04 ..... | 393       | 20-030-18-07 ..... | 405 |
| 16-251-06-01 ..... | 354 | 18-529-30-07 ..... | 369 | 18-611-50-07 ..... | 381      | 19-398-01-04 ..... | 393       | 20-030-18-09 ..... | 405 |
| 16-251-07-01 ..... | 354 | 18-529-35-07 ..... | 369 | 18-630-10-07 ..... | 382      | 19-398-02-04 ..... | 393       | 20-030-21-07 ..... | 405 |
| 16-251-08-01 ..... | 354 | 18-529-45-07 ..... | 369 | 18-630-12-07 ..... | 382      | 19-398-03-04 ..... | 393       | 20-030-21-09 ..... | 405 |
| 16-251-10-01 ..... | 354 | 18-531-01-07 ..... | 369 | 18-630-14-07 ..... | 382      | 19-398-04-04 ..... | 393       | 20-030-23-07 ..... | 405 |
| 16-251-12-01 ..... | 354 | 18-533-01-07 ..... | 370 | 18-630-16-07 ..... | 382      | 19-500-00-07 ..... | 394       | 20-030-23-09 ..... | 405 |
| 16-251-14-01 ..... | 354 | 18-535-00-07 ..... | 370 | 18-630-18-07 ..... | 382      | 19-510-00-07 ..... | 394       | 20-031-15-07 ..... | 405 |
| 16-251-30-01 ..... | 354 | 18-540-15-01 ..... | 370 | 18-630-19-07 ..... | 382      | 19-520-00-07 ..... | 395       | 20-031-15-09 ..... | 405 |
| 16-420-12-01 ..... | 355 | 18-540-20-01 ..... | 370 | 18-630-20-07 ..... | 382      | 19-520-01-07 ..... | 395       | 20-031-18-07 ..... | 405 |
| 16-420-14-01 ..... | 355 | 18-540-25-01 ..... | 370 | 18-632-12-07 ..... | 382      | 19-520-02-07 ..... | 395       | 20-031-18-09 ..... | 405 |
| 16-420-16-01 ..... | 355 | 18-540-35-01 ..... | 370 | 18-632-14-07 ..... | 382      | 19-520-03-07 ..... | 395       | 20-031-21-07 ..... | 405 |
| 16-425-16-07 ..... | 355 | 18-542-21-01 ..... | 371 | 18-632-16-07 ..... | 382      | 19-520-04-07 ..... | 394, 395  | 20-031-21-09 ..... | 405 |
| <b>18</b>          |     | 18-543-27-01 ..... | 371 | 18-640-10-07 ..... | 382      | 19-540-00-07 ..... | 396       | 20-031-23-07 ..... | 405 |
| 18-510-33-07 ..... | 362 | 18-544-16-07 ..... | 371 | 18-640-15-07 ..... | 382      | 19-550-00-07 ..... | 396       | 20-031-23-09 ..... | 405 |
| 18-510-50-07 ..... | 362 | 18-544-20-07 ..... | 371 | 18-640-20-07 ..... | 382      | 19-560-00-07 ..... | 397       | 20-032-15-07 ..... | 405 |
| 18-511-33-07 ..... | 362 | 18-544-28-07 ..... | 371 | 18-641-20-07 ..... | 382      | 19-560-01-07 ..... | 397       | 20-032-15-09 ..... | 405 |
| 18-511-50-07 ..... | 362 | 18-545-00-01 ..... | 372 | 18-642-20-07 ..... | 382      | 19-560-02-07 ..... | 397       | 20-032-18-07 ..... | 405 |
| 18-512-33-07 ..... | 362 | 18-545-01-01 ..... | 372 | 18-645-15-07 ..... | 383      | 19-560-03-07 ..... | 397       | 20-032-18-09 ..... | 405 |
| 18-512-50-07 ..... | 362 | 18-545-02-01 ..... | 372 | 18-645-20-07 ..... | 383      | 19-560-04-07 ..... | 397       | 20-032-21-07 ..... | 405 |
| 18-513-33-07 ..... | 362 | 18-545-10-01 ..... | 372 | 18-645-25-07 ..... | 383      | 19-565-00-07 ..... | 398       | 20-032-21-09 ..... | 405 |
| 18-513-50-07 ..... | 362 | 18-545-11-01 ..... | 372 | 18-645-30-07 ..... | 383      | 19-575-00-07 ..... | 398       | 20-032-23-07 ..... | 405 |
| 18-514-33-07 ..... | 362 | 18-545-12-01 ..... | 372 | 18-647-20-07 ..... | 383      | 19-585-00-07 ..... | 399       | 20-032-23-09 ..... | 405 |
| 18-514-50-07 ..... | 362 | 18-545-13-01 ..... | 372 | 18-695-03-07 ..... | 384      | 19-585-01-07 ..... | 399       | 20-033-15-07 ..... | 405 |
| 18-515-60-07 ..... | 363 | 18-545-15-01 ..... | 372 | 18-695-04-07 ..... | 384      | 19-585-02-07 ..... | 399       | 20-033-15-09 ..... | 405 |
| 18-516-60-07 ..... | 363 | 18-548-19-01 ..... | 373 | 18-695-05-07 ..... | 384      | 19-585-03-07 ..... | 399       | 20-033-18-07 ..... | 405 |
| 18-517-01-07 ..... | 363 | 18-549-19-01 ..... | 373 | 18-695-06-07 ..... | 384      | 19-585-04-07 ..... | 398, 399  | 20-033-18-09 ..... | 405 |
| 18-521-21-01 ..... | 364 | 18-550-22-01 ..... | 373 | 18-696-06-01 ..... | 381, 384 | 19-600-00-02 ..... | 394, 396, | 20-033-21-07 ..... | 405 |
| 18-521-31-01 ..... | 364 | 18-551-22-01 ..... | 373 | 18-700-10-07 ..... | 384      | .....              | 398, 400  | 20-033-21-09 ..... | 405 |
| 18-521-51-01 ..... | 364 | 18-553-09-07 ..... | 374 | 18-700-15-07 ..... | 384      | 19-615-00-02 ..... | 400       | 20-033-23-07 ..... | 405 |
| 18-522-10-01 ..... | 364 | 18-554-09-07 ..... | 374 | 18-700-20-07 ..... | 384      |                    |           | 20-033-23-09 ..... | 405 |
| 18-523-06-01 ..... | 364 | 18-555-09-07 ..... | 374 | 18-700-25-07 ..... | 384      | <b>20</b>          |           | 20-048-18-07 ..... | 405 |
| 18-523-07-01 ..... | 364 | 18-556-06-07 ..... | 374 | 18-700-30-07 ..... | 384      | 20-002-15-07 ..... | 404       | 20-049-18-07 ..... | 405 |
| 18-523-08-01 ..... | 364 | 18-561-35-01 ..... | 375 | 18-700-35-07 ..... | 384      | 20-002-18-07 ..... | 404       | 20-050-18-07 ..... | 405 |
| 18-523-09-01 ..... | 364 | 18-563-31-01 ..... | 375 | 18-700-40-07 ..... | 384      | 20-003-15-07 ..... | 404       | 20-051-18-07 ..... | 405 |
| 18-523-10-01 ..... | 364 | 18-565-30-01 ..... | 375 | 18-700-50-07 ..... | 384      | 20-003-18-07 ..... | 404       | 20-123-01-04 ..... | 402 |
| 18-523-11-01 ..... | 364 | 18-567-33-01 ..... | 375 | 18-710-18-02 ..... | 384      | 20-004-15-07 ..... | 404       | 20-123-02-04 ..... | 402 |
| 18-523-12-01 ..... | 364 | 18-568-28-07 ..... | 376 | 18-800-00-02 ..... | 385      | 20-004-18-07 ..... | 404       | 20-123-03-04 ..... | 402 |
| 18-523-13-01 ..... | 364 | 18-568-30-07 ..... | 376 | 18-802-00-02 ..... | 385      | 20-005-15-07 ..... | 404       | 20-123-04-04 ..... | 402 |
| 18-524-15-01 ..... | 365 | 18-569-21-01 ..... | 377 | 18-804-00-02 ..... | 385      | 20-005-18-07 ..... | 404       | 20-123-05-04 ..... | 402 |
| 18-524-20-01 ..... | 365 | 18-571-21-01 ..... | 377 | 18-806-00-02 ..... | 385      | 20-010-15-07 ..... | 404       | 20-123-06-04 ..... | 402 |
| 18-524-25-01 ..... | 365 | 18-572-05-07 ..... | 377 | 18-825-01-02 ..... | 385      | 20-010-18-07 ..... | 404       | 20-123-07-04 ..... | 402 |
| 18-524-30-01 ..... | 365 | 18-572-10-07 ..... | 377 | 18-825-02-02 ..... | 385      | 20-010-21-07 ..... | 404       | 20-123-08-04 ..... | 402 |
| 18-524-40-01 ..... | 365 | 18-572-15-07 ..... | 377 | 18-825-03-02 ..... | 385      | 20-010-23-07 ..... | 404       | 20-123-09-04 ..... | 402 |
| 18-524-50-01 ..... | 365 | 18-573-05-07 ..... | 377 | 18-840-00-02 ..... | 385      | 20-011-15-07 ..... | 404       | 20-123-10-04 ..... | 402 |
| 18-524-60-01 ..... | 365 | 18-573-10-07 ..... | 377 | 18-845-00-02 ..... | 385      | 20-011-18-07 ..... | 404       | 20-123-11-04 ..... | 402 |
| 18-524-61-01 ..... | 365 | 18-575-05-01 ..... | 378 |                    |          | 20-011-21-07 ..... | 404       | 20-123-12-04 ..... | 402 |
| 18-524-62-01 ..... | 365 | 18-575-06-01 ..... | 378 | <b>19</b>          |          | 20-011-23-07 ..... | 404       | 20-123-13-04 ..... | 402 |
| 18-524-63-01 ..... | 365 | 18-575-07-01 ..... | 378 | 19-301-15-07 ..... | 388      | 20-012-15-07 ..... | 404       | 20-123-14-04 ..... | 402 |
| 18-524-64-01 ..... | 365 | 18-575-08-01 ..... | 378 | 19-301-20-07 ..... | 388      | 20-012-21-07 ..... | 404       | 20-123-15-04 ..... | 402 |
| 18-524-65-01 ..... | 365 | 18-575-24-01 ..... | 378 | 19-303-25-07 ..... | 388      | 20-012-23-07 ..... | 404       | 20-123-16-04 ..... | 402 |
| 18-524-65-01 ..... | 365 | 18-577-01-01 ..... | 378 | 19-305-46-07 ..... | 388      | 20-013-15-07 ..... | 404       | 20-127-01-04 ..... | 402 |
| 18-524-70-01 ..... | 366 | 18-577-02-01 ..... | 378 | 19-350-00-07 ..... | 389      | 20-013-18-07 ..... | 404       | 20-127-02-04 ..... | 402 |
| 18-524-71-01 ..... | 366 | 18-577-03-01 ..... | 378 | 19-351-00-07 ..... | 389      | 20-013-21-07 ..... | 404       | 20-127-03-04 ..... | 402 |

# Nummern-Index

Index of order numbers

Índice de números de referencia

Index numérique des références de commande

Elenco dei codici

|              |     |              |     |              |     |              |     |              |     |
|--------------|-----|--------------|-----|--------------|-----|--------------|-----|--------------|-----|
| 20-127-04-04 | 402 | 20-396-18-07 | 411 | 20-643-26-07 | 422 | 20-845-21-07 | 433 | 23-101-10-07 | 457 |
| 20-127-05-04 | 402 | 20-396-20-07 | 411 | 20-646-18-07 | 422 | 20-846-21-07 | 433 | 23-101-12-07 | 457 |
| 20-127-06-04 | 402 | 20-403-21-07 | 411 | 20-646-20-07 | 422 | 20-847-21-07 | 433 | 23-101-14-07 | 457 |
| 20-127-07-04 | 402 | 20-404-23-07 | 412 | 20-646-23-07 | 422 | 20-848-21-07 | 433 | 23-101-16-07 | 457 |
| 20-127-08-04 | 402 | 20-408-27-07 | 412 | 20-646-26-07 | 422 | 20-849-27-07 | 433 | 23-102-08-07 | 457 |
| 20-127-09-04 | 402 | 20-415-27-07 | 412 | 20-646-31-07 | 422 | 20-850-27-07 | 433 | 23-102-10-07 | 457 |
| 20-127-10-04 | 402 | 20-420-27-07 | 413 | 20-648-27-07 | 422 | 20-851-27-07 | 434 | 23-102-12-07 | 457 |
| 20-127-11-04 | 402 | 20-437-27-07 | 413 | 20-650-13-07 | 423 | 20-852-27-07 | 434 | 23-102-14-07 | 457 |
| 20-127-12-04 | 402 | 20-451-23-07 | 413 | 20-650-15-07 | 423 | 20-853-28-07 | 434 | 23-102-16-07 | 457 |
| 20-127-13-04 | 402 | 20-466-14-07 | 414 | 20-650-18-07 | 423 | 20-854-28-07 | 434 | 23-105-02-07 | 458 |
| 20-127-14-04 | 402 | 20-469-16-07 | 414 | 20-650-20-07 | 423 | 20-855-20-07 | 434 | 23-105-03-07 | 458 |
| 20-127-15-04 | 402 | 20-500-15-07 | 414 | 20-650-23-07 | 423 | 20-856-20-07 | 434 | 23-105-04-07 | 458 |
| 20-127-16-04 | 402 | 20-516-14-07 | 414 | 20-650-26-07 | 423 | 20-857-20-07 | 434 | 23-105-05-07 | 458 |
| 20-133-01-04 | 402 | 20-516-17-07 | 414 | 20-652-15-07 | 423 | 20-858-20-07 | 434 | 23-105-06-07 | 458 |
| 20-133-02-04 | 402 | 20-516-20-07 | 414 | 20-652-17-07 | 423 | 20-859-20-07 | 434 | 23-106-02-07 | 458 |
| 20-133-03-04 | 402 | 20-526-14-07 | 414 | 20-652-20-07 | 423 | 20-860-20-07 | 434 | 23-106-03-07 | 458 |
| 20-133-04-04 | 402 | 20-526-17-07 | 414 | 20-653-27-07 | 423 | 20-861-30-07 | 435 | 23-106-04-07 | 458 |
| 20-133-05-04 | 402 | 20-600-11-07 | 416 | 20-654-13-07 | 424 | 20-862-30-07 | 435 | 23-106-05-07 | 458 |
| 20-133-06-04 | 402 | 20-602-18-07 | 415 | 20-654-15-07 | 424 | 20-863-30-07 | 435 | 23-106-06-07 | 458 |
| 20-133-07-04 | 402 | 20-604-13-07 | 415 | 20-654-18-07 | 424 | 20-864-30-07 | 435 | 23-109-02-07 | 458 |
| 20-133-08-04 | 402 | 20-604-15-07 | 415 | 20-654-20-07 | 424 | 20-867-25-07 | 436 | 23-109-03-07 | 458 |
| 20-133-09-04 | 402 | 20-605-15-07 | 415 | 20-654-23-07 | 424 | 20-871-19-07 | 436 | 23-109-04-07 | 458 |
| 20-154-10-04 | 402 | 20-605-18-07 | 415 | 20-654-26-07 | 424 | 20-872-19-07 | 436 | 23-109-05-07 | 458 |
| 20-154-20-04 | 402 | 20-605-21-07 | 415 | 20-656-27-07 | 424 | 20-875-03-07 | 437 | 23-109-06-07 | 458 |
| 20-154-30-04 | 402 | 20-605-23-07 | 415 | 20-658-14-07 | 425 | 20-875-05-07 | 437 | 23-110-02-07 | 458 |
| 20-155-01-04 | 402 | 20-606-15-07 | 415 | 20-658-18-07 | 425 | 20-875-07-07 | 437 | 23-110-03-07 | 458 |
| 20-155-02-04 | 402 | 20-606-18-07 | 415 | 20-658-20-07 | 425 | 20-877-22-07 | 438 | 23-110-04-07 | 458 |
| 20-155-03-04 | 402 | 20-606-21-07 | 415 | 20-658-23-07 | 425 | 20-878-22-07 | 438 | 23-110-05-07 | 458 |
| 20-155-04-04 | 402 | 20-606-23-07 | 415 | 20-659-20-07 | 425 | 20-882-23-07 | 438 | 23-110-06-07 | 458 |
| 20-155-05-04 | 402 | 20-607-15-07 | 415 | 20-659-24-07 | 425 | 20-886-23-07 | 438 | 23-112-05-04 | 459 |
| 20-175-10-04 | 403 | 20-607-18-07 | 415 | 20-659-26-07 | 425 | 20-894-14-07 | 438 | 23-112-09-04 | 459 |
| 20-175-20-04 | 403 | 20-607-21-07 | 415 | 20-659-28-07 | 425 | 20-910-18-07 | 439 | 23-118-04-07 | 459 |
| 20-176-01-04 | 403 | 20-607-23-07 | 415 | 20-662-20-07 | 425 | 20-916-12-07 | 439 | 23-118-06-07 | 459 |
| 20-176-02-04 | 403 | 20-608-15-07 | 415 | 20-662-24-07 | 425 | 20-922-12-07 | 439 | 23-118-08-07 | 459 |
| 20-176-03-04 | 403 | 20-608-18-07 | 415 | 20-665-22-07 | 426 | 20-924-12-07 | 439 | 23-118-10-07 | 459 |
| 20-176-04-04 | 403 | 20-608-21-07 | 415 | 20-665-23-07 | 426 | 20-928-12-07 | 440 | 23-118-12-07 | 459 |
| 20-176-05-04 | 403 | 20-608-23-07 | 415 | 20-666-00-07 | 426 | 20-929-12-07 | 440 | 23-118-14-07 | 459 |
| 20-298-10-07 | 406 | 20-610-18-07 | 415 | 20-666-02-07 | 426 | 20-935-14-07 | 440 | 23-119-04-07 | 459 |
| 20-298-11-07 | 406 | 20-613-19-07 | 416 | 20-666-03-07 | 426 |              |     | 23-119-06-07 | 459 |
| 20-299-10-07 | 406 | 20-613-23-07 | 416 | 20-666-04-07 | 426 |              |     | 23-119-08-07 | 459 |
| 20-299-11-07 | 406 | 20-613-25-07 | 416 | 20-666-05-07 | 426 |              |     | 23-119-10-07 | 459 |
| 20-300-11-07 | 406 | 20-614-01-07 | 417 | 20-668-00-07 | 426 | 21-155-23-07 | 442 | 23-119-12-07 | 459 |
| 20-300-13-07 | 406 | 20-614-02-07 | 417 | 20-668-01-07 | 426 | 21-160-14-07 | 442 | 23-119-14-07 | 459 |
| 20-300-14-07 | 406 | 20-614-03-07 | 417 | 20-668-02-07 | 426 | 21-165-14-07 | 442 | 23-123-10-07 | 460 |
| 20-301-13-07 | 407 | 20-615-01-07 | 417 | 20-668-03-07 | 426 | 21-165-18-07 | 442 | 23-123-12-07 | 460 |
| 20-302-01-07 | 407 | 20-615-02-07 | 417 | 20-670-00-07 | 427 | 21-165-20-07 | 442 | 23-123-15-07 | 460 |
| 20-303-01-07 | 407 | 20-615-03-07 | 417 | 20-670-01-07 | 427 | 21-195-23-07 | 443 | 23-123-20-07 | 460 |
| 20-303-09-07 | 407 | 20-615-04-07 | 417 | 20-670-02-07 | 427 | 21-205-20-07 | 443 | 23-123-25-07 | 460 |
| 20-304-01-07 | 407 | 20-620-00-07 | 418 | 20-670-07-07 | 427 | 21-209-15-01 | 444 | 23-123-25-07 | 460 |
| 20-304-09-07 | 407 | 20-620-01-07 | 418 | 20-670-10-07 | 427 | 21-209-18-01 | 444 | 23-124-08-07 | 460 |
| 20-305-01-07 | 407 | 20-620-14-07 | 418 | 20-672-14-07 | 427 | 21-223-24-07 | 444 | 23-124-10-07 | 460 |
| 20-306-14-07 | 408 | 20-620-18-07 | 418 | 20-672-17-07 | 427 | 21-223-26-07 | 444 | 23-124-12-07 | 460 |
| 20-307-14-07 | 408 | 20-620-21-07 | 418 | 20-672-18-07 | 427 | 21-275-23-07 | 445 | 23-124-15-07 | 460 |
| 20-308-14-07 | 408 | 20-621-14-07 | 418 | 20-673-12-07 | 428 | 21-275-26-07 | 445 | 23-124-20-07 | 460 |
| 20-309-14-07 | 408 | 20-621-18-07 | 418 | 20-673-15-07 | 428 | 21-275-37-07 | 445 | 23-124-25-07 | 460 |
| 20-310-14-07 | 408 | 20-621-21-07 | 418 | 20-673-16-07 | 428 | 21-277-23-07 | 445 | 23-125-10-07 | 461 |
| 20-311-14-07 | 408 | 20-624-13-07 | 419 | 20-674-14-07 | 428 | 21-277-26-07 | 445 | 23-125-12-07 | 461 |
| 20-313-14-07 | 408 | 20-624-13-07 | 419 | 20-674-17-07 | 428 | 21-277-37-07 | 445 | 23-125-15-07 | 461 |
| 20-326-12-07 | 409 | 20-626-13-07 | 419 | 20-674-20-07 | 428 | 21-291-18-07 | 446 | 23-125-20-07 | 461 |
| 20-328-12-07 | 409 | 20-628-13-07 | 419 | 20-676-14-07 | 429 | 21-297-24-07 | 446 | 23-125-25-07 | 461 |
| 20-332-12-07 | 409 | 20-630-13-07 | 419 | 20-676-17-07 | 429 | 21-401-20-07 | 447 | 23-127-10-07 | 461 |
| 20-334-13-07 | 409 | 20-631-13-07 | 419 | 20-676-20-07 | 429 | 21-420-18-07 | 447 | 23-127-12-07 | 461 |
| 20-336-13-07 | 409 | 20-632-12-07 | 419 | 20-678-17-07 | 429 | 21-431-21-07 | 447 | 23-127-15-07 | 461 |
| 20-338-13-07 | 409 | 20-634-13-07 | 420 | 20-678-20-07 | 429 | 21-520-28-07 | 448 | 23-127-20-07 | 461 |
| 20-340-14-07 | 410 | 20-634-14-07 | 420 | 20-684-18-07 | 429 | 21-522-23-07 | 448 | 23-127-25-07 | 461 |
| 20-344-13-07 | 410 | 20-636-13-07 | 420 | 20-685-18-07 | 430 | 21-541-18-07 | 449 | 23-130-00-04 | 462 |
| 20-344-18-07 | 410 | 20-637-12-07 | 420 | 20-692-18-07 | 430 | 21-545-24-07 | 449 | 23-130-05-07 | 462 |
| 20-348-15-07 | 410 | 20-637-13-07 | 420 | 20-692-20-07 | 430 | 21-551-00-04 | 450 | 23-130-10-07 | 462 |
| 20-350-15-07 | 410 | 20-638-15-07 | 420 | 20-692-23-07 | 430 | 21-551-01-04 | 450 | 23-130-16-07 | 462 |
| 20-360-18-07 | 410 | 20-638-20-07 | 420 | 20-813-32-07 | 431 | 21-553-50-07 | 450 | 23-130-25-07 | 462 |
| 20-364-18-07 | 410 | 20-640-18-07 | 421 | 20-815-21-07 | 431 | 21-553-65-07 | 450 | 23-130-55-07 | 462 |
| 20-384-17-07 | 411 | 20-640-20-07 | 421 | 20-825-20-07 | 432 |              |     | 23-130-60-07 | 462 |
| 20-390-14-07 | 411 | 20-640-26-07 | 421 | 20-832-19-07 | 432 |              |     | 23-130-66-07 | 462 |
| 20-390-16-07 | 411 | 20-642-16-07 | 421 | 20-835-13-07 | 432 |              |     | 23-130-85-07 | 462 |
| 20-390-18-07 | 411 | 20-642-18-07 | 421 | 20-837-13-07 | 432 | 23-072-04-07 | 456 | 23-130-90-98 | 462 |
| 20-390-20-07 | 411 | 20-642-20-07 | 421 | 20-839-24-07 | 433 | 23-074-04-07 | 456 | 23-130-99-07 | 462 |
| 20-390-24-07 | 411 | 20-642-24-07 | 421 | 20-840-24-07 | 433 | 23-100-08-07 | 456 | 23-131-05-04 | 463 |
| 20-390-26-07 | 411 | 20-642-26-07 | 421 | 20-841-20-07 | 433 | 23-100-10-07 | 456 | 23-131-10-04 | 463 |
| 20-390-30-07 | 411 | 20-642-30-07 | 421 | 20-842-20-07 | 433 | 23-100-12-07 | 456 | 23-131-15-04 | 463 |
| 20-396-16-07 | 411 | 20-643-20-07 | 422 | 20-843-20-07 | 433 | 23-100-14-07 | 456 | 23-131-55-04 | 463 |
|              |     | 20-643-24-07 | 422 | 20-844-20-07 | 433 | 23-100-16-07 | 456 | 23-131-60-04 | 463 |

## Nummern-Index

Index of order numbers

Índice de números de referencia

Index numérique des références de commande

Elenco dei codici

## Index

Index

Indice

Index

Indice

|              |     |              |          |              |     |              |     |              |     |
|--------------|-----|--------------|----------|--------------|-----|--------------|-----|--------------|-----|
| 23-131-65-04 | 463 | 23-160-01-04 | 470      | 23-282-01-04 | 481 | 23-354-20-07 | 486 | 23-486-17-07 | 498 |
| 23-132-04-04 | 464 | 23-160-02-04 | 470      | 23-282-02-04 | 481 | 23-356-21-07 | 486 | 23-487-17-07 | 498 |
| 23-132-06-04 | 464 | 23-160-03-04 | 470      | 23-282-03-04 | 481 | 23-358-00-07 | 487 | 23-490-01-07 | 498 |
| 23-132-08-04 | 464 | 23-160-04-04 | 470      | 23-282-04-04 | 481 | 23-358-01-07 | 487 | 23-490-02-07 | 498 |
| 23-132-10-04 | 464 | 23-162-03-07 | 471      | 23-282-10-04 | 481 | 23-358-12-07 | 487 | 23-490-03-07 | 498 |
| 23-132-12-04 | 464 | 23-162-06-07 | 471      | 23-300-10-07 | 482 | 23-359-00-07 | 487 | 23-490-04-07 | 498 |
| 23-133-04-04 | 464 | 23-162-08-07 | 471      | 23-300-20-07 | 482 | 23-359-10-07 | 487 | 23-490-05-07 | 498 |
| 23-133-06-04 | 464 | 23-162-09-07 | 471      | 23-300-30-07 | 482 | 23-359-11-07 | 487 | 23-491-01-07 | 499 |
| 23-133-08-04 | 464 | 23-170-06-07 | 471      | 23-301-01-07 | 482 | 23-395-24-07 | 487 | 23-491-02-07 | 499 |
| 23-133-10-04 | 464 | 23-170-13-07 | 471      | 23-301-02-07 | 482 | 23-400-01-07 | 488 | 23-491-03-07 | 499 |
| 23-133-12-04 | 464 | 23-170-19-07 | 471      | 23-301-03-07 | 482 | 23-400-02-07 | 488 | 23-491-04-07 | 499 |
| 23-134-05-04 | 465 | 23-170-25-07 | 471      | 23-301-04-07 | 482 | 23-400-03-07 | 488 | 23-492-01-07 | 499 |
| 23-134-07-04 | 465 | 23-170-32-07 | 471      | 23-304-10-07 | 482 | 23-400-04-07 | 488 | 23-493-01-07 | 499 |
| 23-134-10-04 | 465 | 23-172-06-07 | 471      | 23-304-20-07 | 482 | 23-400-10-07 | 488 | 23-495-20-07 | 500 |
| 23-134-15-04 | 465 | 23-172-13-07 | 471      | 23-304-30-07 | 482 | 23-400-11-07 | 488 | 23-497-20-07 | 500 |
| 23-134-20-04 | 465 | 23-172-19-07 | 471      | 23-304-40-07 | 482 | 23-400-12-07 | 488 | 23-499-01-07 | 500 |
| 23-134-25-04 | 465 | 23-172-25-07 | 471      | 23-305-01-07 | 482 | 23-400-20-07 | 489 | 23-499-02-07 | 500 |
| 23-134-30-04 | 465 | 23-172-32-07 | 471      | 23-305-02-07 | 482 | 23-400-21-07 | 489 | 23-499-03-07 | 500 |
| 23-135-05-04 | 465 | 23-173-06-07 | 472      | 23-305-03-07 | 482 | 23-400-25-07 | 489 | 23-499-04-07 | 500 |
| 23-135-07-04 | 465 | 23-173-13-07 | 472      | 23-305-04-07 | 482 | 23-400-26-07 | 489 | 23-510-17-07 | 501 |
| 23-135-10-04 | 465 | 23-173-19-07 | 472      | 23-305-05-07 | 482 | 23-400-30-07 | 489 | 23-513-16-07 | 501 |
| 23-135-15-04 | 465 | 23-173-25-07 | 472      | 23-305-06-07 | 482 | 23-401-18-07 | 490 | 23-516-18-07 | 501 |
| 23-135-20-04 | 465 | 23-173-32-07 | 472      | 23-306-10-07 | 482 | 23-402-19-07 | 490 | 23-517-20-07 | 501 |
| 23-135-25-04 | 465 | 23-176-06-07 | 472      | 23-306-20-07 | 482 | 23-404-18-07 | 490 | 23-525-21-07 | 501 |
| 23-135-30-04 | 465 | 23-176-13-07 | 472      | 23-306-30-07 | 482 | 23-406-16-07 | 490 | 23-526-18-07 | 501 |
| 23-136-02-07 | 466 | 23-176-19-07 | 472      | 23-306-40-07 | 482 | 23-412-20-07 | 490 | 23-527-19-07 | 501 |
| 23-136-03-07 | 466 | 23-176-25-07 | 472      | 23-308-10-07 | 483 | 23-414-19-07 | 490 | 23-537-06-07 | 502 |
| 23-136-04-07 | 466 | 23-176-32-07 | 472      | 23-308-20-07 | 483 | 23-416-11-07 | 491 | 23-539-06-07 | 502 |
| 23-136-06-07 | 466 | 23-177-06-07 | 472      | 23-308-30-07 | 483 | 23-417-11-07 | 491 | 23-539-08-07 | 502 |
| 23-136-08-07 | 466 | 23-177-13-07 | 472      | 23-308-40-07 | 483 | 23-418-15-07 | 491 | 23-539-15-07 | 502 |
| 23-136-10-07 | 466 | 23-177-19-07 | 472      | 23-309-01-07 | 483 | 23-419-15-07 | 491 | 23-539-16-07 | 502 |
| 23-136-12-07 | 466 | 23-177-25-07 | 472      | 23-309-02-07 | 483 | 23-423-01-07 | 491 | 23-541-08-07 | 503 |
| 23-136-15-07 | 466 | 23-177-32-07 | 472      | 23-309-03-07 | 483 | 23-423-02-07 | 491 | 23-541-18-07 | 503 |
| 23-136-53-07 | 466 | 23-181-30-07 | 473      | 23-309-05-07 | 483 | 23-423-04-07 | 491 | 23-541-43-07 | 503 |
| 23-136-54-07 | 466 | 23-197-03-04 | 474      | 23-309-06-07 | 483 | 23-423-05-07 | 491 | 23-541-70-07 | 504 |
| 23-136-56-07 | 466 | 23-197-05-04 | 474      | 23-312-10-07 | 483 | 23-423-06-07 | 491 | 23-543-43-07 | 504 |
| 23-136-58-07 | 466 | 23-197-08-04 | 474      | 23-312-30-07 | 483 | 23-423-07-07 | 491 | 23-545-22-07 | 504 |
| 23-136-60-07 | 466 | 23-198-02-07 | 474      | 23-312-40-07 | 483 | 23-425-06-07 | 492 | 23-545-35-07 | 505 |
| 23-136-62-07 | 466 | 23-198-03-07 | 474      | 23-313-01-07 | 483 | 23-425-10-07 | 492 | 23-547-24-07 | 505 |
| 23-136-65-07 | 466 | 23-198-04-07 | 474      | 23-313-02-07 | 483 | 23-425-13-07 | 492 | 23-549-22-07 | 505 |
| 23-138-04-07 | 467 | 23-198-05-07 | 474      | 23-313-03-07 | 483 | 23-425-19-07 | 492 | 23-559-24-01 | 506 |
| 23-138-06-07 | 467 | 23-198-06-07 | 474      | 23-313-04-07 | 483 | 23-425-25-07 | 492 | 23-561-24-01 | 506 |
| 23-138-08-07 | 467 | 23-198-08-07 | 474      | 23-313-05-07 | 483 | 23-426-06-07 | 492 | 23-563-26-07 | 507 |
| 23-138-10-07 | 467 | 23-198-10-07 | 474      | 23-334-10-07 | 484 | 23-426-10-07 | 492 | 23-565-26-07 | 507 |
| 23-138-13-07 | 467 | 23-199-12-04 | 474      | 23-334-20-07 | 484 | 23-426-13-07 | 492 | 23-567-17-07 | 507 |
| 23-138-15-07 | 467 | 23-199-14-04 | 474      | 23-334-30-07 | 484 | 23-426-19-07 | 492 | 23-571-16-07 | 507 |
| 23-138-18-07 | 467 | 23-199-16-04 | 474      | 23-335-01-07 | 484 | 23-426-25-07 | 492 | 23-573-16-07 | 507 |
| 23-138-20-07 | 467 | 23-200-01-07 | 475      | 23-335-02-07 | 484 | 23-428-06-04 | 493 | 23-654-40-07 | 508 |
| 23-138-25-07 | 467 | 23-200-02-07 | 475      | 23-335-03-07 | 484 | 23-429-14-04 | 493 | 23-654-45-07 | 508 |
| 23-138-30-07 | 467 | 23-200-03-07 | 475      | 23-335-04-07 | 484 | 23-432-14-04 | 493 | 23-654-55-07 | 508 |
| 23-138-38-07 | 467 | 23-204-01-07 | 475      | 23-335-05-07 | 484 | 23-432-18-04 | 493 | 23-656-00-07 | 508 |
| 23-138-44-07 | 467 | 23-204-02-07 | 475      | 23-335-06-07 | 484 | 23-433-03-04 | 493 | 23-656-01-07 | 508 |
| 23-138-50-07 | 467 | 23-204-03-07 | 475      | 23-336-25-07 | 484 | 23-433-13-04 | 493 | 23-662-29-07 | 508 |
| 23-139-04-07 | 468 | 23-208-20-07 | 476      | 23-337-25-07 | 484 | 23-433-18-04 | 494 | 23-664-23-02 | 508 |
| 23-139-06-07 | 468 | 23-214-01-07 | 476      | 23-339-25-07 | 484 | 23-434-13-07 | 494 | 23-674-16-07 | 509 |
| 23-139-08-07 | 468 | 23-214-02-07 | 476      | 23-340-01-07 | 484 | 23-436-04-07 | 494 | 23-676-15-07 | 509 |
| 23-139-10-07 | 468 | 23-215-19-07 | 476      | 23-340-02-07 | 484 | 23-436-05-07 | 494 | 23-676-19-07 | 509 |
| 23-139-13-07 | 468 | 23-216-01-07 | 477      | 23-340-03-07 | 484 | 23-436-07-07 | 494 | 23-676-24-07 | 509 |
| 23-139-15-07 | 468 | 23-218-22-04 | 477      | 23-340-04-07 | 484 | 23-436-16-07 | 494 | 23-678-00-07 | 509 |
| 23-139-18-07 | 468 | 23-220-17-02 | 477      | 23-340-05-07 | 484 | 23-437-20-04 | 494 | 23-678-01-07 | 509 |
| 23-139-20-07 | 468 | 23-221-00-04 | 477      | 23-340-06-07 | 484 | 23-439-08-07 | 494 | 23-679-11-07 | 509 |
| 23-139-25-07 | 468 | 23-224-18-07 | 478      | 23-342-01-07 | 485 | 23-441-17-07 | 495 | 23-680-13-07 | 510 |
| 23-139-30-07 | 468 | 23-240-29-04 | 478, 479 | 23-342-10-07 | 485 | 23-443-17-07 | 495 | 23-681-20-07 | 510 |
| 23-139-38-07 | 468 | 23-242-24-04 | 478      | 23-342-20-07 | 485 | 23-445-17-07 | 495 | 23-682-15-07 | 510 |
| 23-139-44-07 | 468 | 23-244-24-04 | 479      | 23-342-30-07 | 485 | 23-447-17-07 | 495 | 23-683-15-07 | 510 |
| 23-139-50-07 | 468 | 23-253-22-04 | 479      | 23-344-01-07 | 485 | 23-448-21-07 | 496 | 23-704-14-07 | 511 |
| 23-154-06-07 | 469 | 23-254-22-04 | 478, 479 | 23-344-02-07 | 485 | 23-450-01-07 | 496 | 23-710-20-07 | 511 |
| 23-154-09-07 | 469 | 23-256-00-04 | 478, 479 | 23-344-03-07 | 485 | 23-450-02-07 | 496 | 23-711-20-07 | 511 |
| 23-154-13-07 | 469 | 23-260-01-04 | 480      | 23-344-04-07 | 485 | 23-450-03-07 | 496 | 23-713-20-07 | 511 |
| 23-154-16-07 | 469 | 23-260-02-04 | 480      | 23-344-05-07 | 485 | 23-450-04-07 | 496 | 23-715-19-07 | 511 |
| 23-154-19-07 | 469 | 23-280-01-04 | 481      | 23-344-06-07 | 485 | 23-450-05-07 | 496 | 23-716-19-07 | 512 |
| 23-154-25-07 | 469 | 23-280-02-04 | 481      | 23-350-01-07 | 485 | 23-461-05-07 | 496 | 23-717-12-07 | 512 |
| 23-154-32-07 | 469 | 23-280-03-04 | 481      | 23-350-02-07 | 485 | 23-461-10-07 | 496 | 23-718-17-07 | 512 |
| 23-155-06-07 | 469 | 23-280-04-04 | 481      | 23-350-03-07 | 485 | 23-461-15-07 | 496 | 23-720-14-07 | 512 |
| 23-155-09-07 | 469 | 23-280-05-04 | 481      | 23-351-14-07 | 486 | 23-461-20-07 | 496 | 23-721-09-07 | 512 |
| 23-155-13-07 | 469 | 23-280-06-04 | 481      | 23-352-13-07 | 486 | 23-461-25-07 | 496 | 23-721-14-07 | 512 |
| 23-155-16-07 | 469 | 23-280-10-04 | 481      | 23-352-14-07 | 486 | 23-481-24-07 | 497 | 23-722-21-07 | 513 |
| 23-155-19-07 | 469 | 23-280-20-04 | 481      | 23-352-17-07 | 486 | 23-482-22-07 | 497 | 23-724-21-07 | 513 |
| 23-155-25-07 | 469 | 23-280-30-04 | 481      | 23-354-13-07 | 486 | 23-484-17-07 | 498 | 23-726-18-07 | 513 |
| 23-155-32-07 | 469 | 23-280-40-04 | 481      | 23-354-16-07 | 486 | 23-485-17-07 | 498 | 23-727-20-07 | 514 |

# Nummern-Index

Index of order numbers

Índice de números de referencia

Index numérique des références de commande

Elenco dei codici

|              |     |
|--------------|-----|
| 23-729-16-07 | 514 |
| 23-729-24-07 | 514 |
| 23-730-17-07 | 515 |
| 23-730-21-07 | 515 |
| 23-731-19-07 | 515 |
| 23-732-26-07 | 516 |
| 23-734-26-07 | 516 |
| 23-746-23-07 | 517 |
| 23-746-25-07 | 517 |
| 23-746-28-07 | 517 |
| 23-747-23-07 | 517 |
| 23-747-25-07 | 517 |
| 23-747-28-07 | 517 |
| 23-749-15-07 | 518 |
| 23-749-19-07 | 518 |
| 23-749-24-07 | 518 |
| 23-749-26-07 | 518 |
| 23-749-28-07 | 518 |
| 23-749-90-98 | 518 |
| 23-750-33-07 | 519 |
| 23-752-33-07 | 519 |
| 23-755-01-07 | 520 |
| 23-755-02-07 | 520 |
| 23-755-03-07 | 520 |
| 23-757-01-07 | 521 |
| 23-762-30-07 | 521 |
| 23-777-01-07 | 522 |
| 23-777-02-07 | 522 |
| 23-799-12-07 | 522 |
| 23-801-14-07 | 522 |
| 23-803-14-07 | 522 |
| 23-805-14-07 | 522 |
| 23-807-17-07 | 522 |
| 23-815-16-07 | 523 |
| 23-816-16-07 | 523 |
| 23-819-18-07 | 523 |
| 23-826-18-07 | 523 |
| 23-828-18-07 | 523 |
| 23-829-18-07 | 523 |
| 23-832-19-07 | 523 |
| 23-833-19-07 | 523 |
| 23-835-15-07 | 524 |
| 23-835-30-07 | 524 |
| 23-836-00-07 | 524 |
| 23-836-30-07 | 524 |
| 23-836-90-07 | 524 |
| 23-837-15-07 | 524 |
| 23-839-15-07 | 524 |
| 23-846-17-07 | 525 |
| 23-847-17-07 | 525 |
| 23-853-15-07 | 525 |
| 23-864-15-07 | 525 |
| 23-865-15-07 | 525 |
| 23-876-15-07 | 525 |
| 23-877-15-07 | 525 |
| 23-879-18-07 | 525 |
| 23-881-18-07 | 525 |
| 23-883-17-07 | 526 |
| 23-885-20-07 | 526 |
| 23-887-18-07 | 526 |
| 23-893-23-07 | 526 |
| 23-895-22-07 | 526 |
| 23-897-23-07 | 526 |
| 23-899-02-07 | 527 |
| 23-899-03-07 | 527 |
| 23-899-04-07 | 527 |
| 23-901-23-07 | 527 |
| 23-905-24-07 | 528 |
| 23-907-24-07 | 528 |
| 23-909-24-07 | 528 |
| 23-910-22-07 | 529 |
| 23-911-22-07 | 529 |
| 23-930-19-07 | 530 |
| 23-934-14-07 | 530 |
| 23-934-17-07 | 530 |
| 23-934-19-07 | 530 |
| 23-934-22-07 | 530 |
| 23-935-14-07 | 530 |
| 23-935-17-07 | 530 |
| 23-935-19-07 | 530 |

|              |     |
|--------------|-----|
| 23-935-22-07 | 530 |
| 23-939-17-07 | 531 |
| 23-941-15-07 | 531 |
| 23-944-15-07 | 531 |
| 23-946-15-07 | 531 |
| 23-950-18-07 | 532 |
| 23-951-18-07 | 532 |
| 23-952-27-07 | 532 |
| 23-954-27-07 | 533 |
| 23-955-23-07 | 533 |
| 23-955-27-07 | 533 |
| 23-957-27-07 | 534 |

## 27

|              |     |
|--------------|-----|
| 27-113-14-07 | 548 |
| 27-115-14-07 | 548 |
| 27-125-16-07 | 549 |
| 27-127-16-07 | 549 |
| 27-143-13-07 | 549 |
| 27-145-11-07 | 549 |
| 27-151-17-07 | 549 |
| 27-155-17-07 | 549 |
| 27-411-15-07 | 550 |
| 27-413-15-07 | 550 |
| 27-449-15-07 | 550 |
| 27-449-20-07 | 550 |

## 28

|              |     |
|--------------|-----|
| 28-400-13-07 | 100 |
| 28-401-13-07 | 100 |
| 28-404-12-07 | 114 |
| 28-405-12-07 | 114 |
| 28-408-14-07 | 24  |
| 28-408-17-07 | 24  |
| 28-409-14-07 | 25  |
| 28-409-17-07 | 25  |
| 28-410-16-07 | 46  |
| 28-411-16-07 | 47  |
| 28-413-15-07 | 27  |
| 28-413-16-07 | 116 |
| 28-413-17-07 | 27  |
| 28-418-14-07 | 62  |
| 28-419-14-07 | 62  |
| 28-420-14-07 | 63  |
| 28-421-14-07 | 63  |
| 28-422-14-07 | 56  |
| 28-423-14-07 | 57  |
| 28-423-18-07 | 57  |
| 28-424-11-07 | 37  |
| 28-424-14-07 | 37  |
| 28-424-18-07 | 41  |
| 28-424-20-07 | 41  |
| 28-425-11-07 | 38  |
| 28-425-14-07 | 38  |
| 28-425-18-07 | 42  |
| 28-425-20-07 | 42  |
| 28-426-23-07 | 41  |
| 28-426-26-07 | 41  |
| 28-426-30-07 | 41  |
| 28-427-23-07 | 42  |
| 28-427-26-07 | 42  |
| 28-427-30-07 | 42  |
| 28-428-14-07 | 53  |
| 28-428-18-07 | 53  |
| 28-428-20-07 | 53  |
| 28-428-23-07 | 53  |
| 28-429-14-07 | 55  |
| 28-429-18-07 | 55  |
| 28-429-20-07 | 55  |
| 28-429-23-07 | 55  |
| 28-429-26-07 | 55  |
| 28-429-28-07 | 55  |
| 28-431-18-07 | 58  |
| 28-431-20-07 | 58  |
| 28-431-23-07 | 58  |
| 28-432-15-07 | 60  |
| 28-433-15-07 | 61  |
| 28-434-16-07 | 32  |
| 28-435-16-07 | 33  |
| 28-437-18-07 | 78  |

|              |     |
|--------------|-----|
| 28-445-17-07 | 118 |
| 28-453-18-07 | 86  |
| 28-459-13-07 | 84  |
| 28-461-16-07 | 85  |
| 28-463-17-07 | 80  |
| 28-464-11-07 | 97  |
| 28-465-11-07 | 98  |
| 28-466-14-07 | 24  |
| 28-466-17-07 | 24  |
| 28-467-14-07 | 25  |
| 28-467-17-07 | 25  |
| 28-468-16-07 | 46  |
| 28-469-16-07 | 47  |
| 28-471-15-07 | 27  |
| 28-471-17-07 | 27  |
| 28-472-20-07 | 41  |
| 28-472-23-07 | 41  |
| 28-473-18-07 | 58  |
| 28-473-20-07 | 58  |
| 28-473-23-07 | 58  |
| 28-474-16-07 | 32  |
| 28-475-16-07 | 33  |
| 28-477-18-07 | 78  |
| 28-479-16-07 | 85  |
| 28-481-13-07 | 84  |

## 30

|              |     |
|--------------|-----|
| 30-130-12-07 | 556 |
| 30-131-15-07 | 556 |
| 30-132-15-07 | 556 |
| 30-134-15-07 | 556 |
| 30-134-19-07 | 556 |
| 30-134-25-07 | 556 |
| 30-136-16-07 | 556 |
| 30-136-20-07 | 556 |
| 30-136-25-07 | 556 |
| 30-136-30-07 | 556 |
| 30-138-15-07 | 557 |
| 30-142-15-07 | 557 |
| 30-148-15-07 | 557 |
| 30-148-19-07 | 557 |
| 30-150-20-07 | 557 |
| 30-154-20-07 | 557 |
| 30-170-20-07 | 557 |
| 30-186-16-07 | 558 |
| 30-190-16-07 | 558 |
| 30-190-20-07 | 558 |
| 30-192-16-07 | 559 |
| 30-192-18-07 | 559 |
| 30-192-20-07 | 559 |
| 30-192-24-07 | 559 |
| 30-196-16-07 | 559 |
| 30-196-20-07 | 559 |
| 30-206-20-07 | 559 |
| 30-210-18-07 | 560 |
| 30-210-20-07 | 560 |
| 30-212-20-07 | 560 |
| 30-212-23-07 | 560 |
| 30-274-21-07 | 560 |
| 30-274-23-07 | 560 |
| 30-275-21-07 | 560 |
| 30-275-23-07 | 560 |
| 30-276-18-07 | 561 |
| 30-277-18-07 | 561 |
| 30-286-21-07 | 562 |
| 30-286-23-07 | 562 |
| 30-287-21-07 | 562 |
| 30-287-23-07 | 562 |
| 30-288-25-07 | 562 |
| 30-289-25-07 | 562 |
| 30-304-22-07 | 563 |
| 30-304-25-07 | 563 |
| 30-304-28-07 | 563 |
| 30-305-22-07 | 564 |
| 30-305-25-07 | 564 |
| 30-305-28-07 | 564 |
| 30-398-16-07 | 564 |
| 30-415-15-07 | 565 |
| 30-419-21-07 | 565 |
| 30-425-29-07 | 565 |

|              |     |
|--------------|-----|
| 30-433-35-07 | 565 |
| 30-496-05-07 | 566 |
| 30-496-07-07 | 566 |
| 30-496-10-07 | 566 |
| 30-497-26-07 | 566 |
| 30-498-08-07 | 567 |
| 30-498-23-07 | 567 |
| 30-519-16-07 | 567 |
| 30-534-30-07 | 568 |
| 30-535-30-07 | 569 |
| 30-540-18-07 | 570 |
| 30-540-20-07 | 570 |
| 30-540-23-07 | 570 |
| 30-550-13-07 | 571 |
| 30-550-16-07 | 571 |
| 30-550-18-07 | 571 |
| 30-550-21-07 | 571 |
| 30-550-23-07 | 571 |
| 30-551-13-07 | 571 |
| 30-551-16-07 | 571 |
| 30-551-18-07 | 571 |
| 30-551-21-07 | 571 |
| 30-551-23-07 | 571 |
| 30-554-25-07 | 572 |
| 30-555-25-07 | 572 |
| 30-560-22-07 | 573 |
| 30-560-25-07 | 573 |
| 30-560-28-07 | 573 |
| 30-561-22-07 | 574 |
| 30-561-25-07 | 574 |
| 30-561-28-07 | 574 |
| 30-570-33-07 | 575 |
| 30-571-33-07 | 575 |
| 30-580-24-07 | 575 |
| 30-581-26-07 | 576 |
| 30-581-28-07 | 576 |
| 30-583-23-07 | 577 |
| 30-585-24-07 | 577 |
| 30-587-30-07 | 578 |
| 30-610-21-07 | 579 |
| 30-613-15-01 | 579 |
| 30-615-15-01 | 579 |
| 30-624-20-07 | 579 |
| 30-641-15-07 | 579 |
| 30-647-00-07 | 580 |
| 30-647-92-98 | 580 |
| 30-647-93-98 | 580 |
| 30-647-94-98 | 580 |
| 30-647-95-98 | 580 |
| 30-649-01-07 | 581 |
| 30-649-02-07 | 581 |
| 30-724-19-07 | 582 |
| 30-741-38-07 | 582 |

## 31

|              |     |
|--------------|-----|
| 31-101-23-07 | 584 |
| 31-103-22-07 | 584 |
| 31-105-22-07 | 584 |
| 31-107-22-07 | 584 |
| 31-113-16-07 | 584 |
| 31-113-17-07 | 584 |
| 31-170-01-01 | 585 |
| 31-170-02-01 | 585 |
| 31-170-03-01 | 585 |
| 31-170-04-01 | 585 |
| 31-170-05-01 | 585 |
| 31-170-06-01 | 585 |
| 31-170-07-01 | 585 |
| 31-170-08-01 | 585 |
| 31-170-09-01 | 585 |
| 31-170-10-01 | 585 |
| 31-170-11-01 | 585 |
| 31-170-12-01 | 585 |
| 31-170-13-01 | 585 |
| 31-204-20-07 | 586 |
| 31-205-20-07 | 586 |
| 31-215-20-07 | 586 |
| 31-217-22-07 | 587 |
| 31-223-23-07 | 587 |
| 31-225-23-07 | 587 |

|              |     |
|--------------|-----|
| 31-340-01-07 | 588 |
| 31-340-02-07 | 588 |
| 31-340-03-07 | 588 |
| 31-340-04-07 | 588 |
| 31-340-05-07 | 588 |
| 31-340-06-07 | 588 |
| 31-340-07-07 | 588 |
| 31-340-08-07 | 588 |
| 31-401-21-07 | 589 |
| 31-405-21-07 | 589 |
| 31-407-22-07 | 589 |
| 31-451-24-07 | 590 |
| 31-453-24-07 | 590 |
| 31-461-23-07 | 590 |
| 31-463-23-07 | 591 |
| 31-475-00-07 | 592 |
| 31-510-00-07 | 592 |
| 31-512-00-07 | 593 |
| 31-512-90-98 | 593 |
| 31-512-91-98 | 593 |
| 31-512-92-98 | 593 |
| 31-599-00-07 | 594 |
| 31-599-08-07 | 594 |
| 31-599-10-07 | 594 |
| 31-599-12-07 | 594 |
| 31-599-14-07 | 594 |
| 31-599-16-07 | 594 |
| 31-599-18-07 | 594 |
| 31-599-20-07 | 594 |
| 31-599-22-07 | 594 |
| 31-599-24-07 | 594 |
| 31-599-26-07 | 594 |
| 31-599-28-07 | 594 |
| 31-599-30-07 | 594 |
| 31-599-32-07 | 594 |
| 31-599-34-07 | 594 |
| 31-599-36-07 | 594 |
| 31-607-10-07 | 594 |
| 31-607-11-07 | 594 |
| 31-607-12-07 | 594 |
| 31-607-13-07 | 594 |
| 31-607-14-07 | 594 |
| 31-607-15-07 | 594 |
| 31-607-16-07 | 594 |
| 31-607-17-07 | 594 |
| 31-607-18-07 | 594 |
| 31-607-19-07 | 594 |
| 31-607-20-07 | 594 |
| 31-607-21-07 | 594 |
| 31-607-22-07 | 594 |
| 31-607-23-07 | 594 |
| 31-607-24-07 | 594 |
| 31-607-25-07 | 594 |
| 31-607-26-07 | 594 |
| 31-607-27-07 | 594 |
| 31-607-28-07 | 594 |
| 31-607-29-07 | 594 |
| 31-607-30-07 | 594 |
| 31-721-12-01 | 595 |
| 31-721-14-01 | 595 |
| 31-765-08-07 | 596 |
| 31-765-11-07 | 596 |
| 31-765-13-07 | 596 |
| 31-765-16-07 | 596 |
| 31-765-21-07 | 596 |
| 31-765-26-07 | 596 |
| 31-765-32-07 | 596 |
| 31-766-00-07 | 596 |
| 31-811-20-07 | 597 |
| 31-811-28-07 | 597 |
| 31-875-08-01 | 598 |
| 31-881-11-01 | 598 |
| 31-881-90-98 | 598 |

## 32

|              |     |
|--------------|-----|
| 32-110-01-01 | 600 |
| 32-110-02-01 | 600 |
| 32-110-03-01 | 600 |
| 32-112-01-01 | 600 |
| 32-114-01-01 | 600 |



## Nummern-Index

Index of order numbers

Índice de números de referencia

Index numérique des références de commande

Elenco dei codici

## Index

Index

Indice

Index

Indice



|                    |     |                    |          |                    |     |                    |     |                    |     |
|--------------------|-----|--------------------|----------|--------------------|-----|--------------------|-----|--------------------|-----|
| 32-114-02-01 ..... | 600 | 32-302-10-01 ..... | 610      | 32-430-82-01 ..... | 616 | 32-920-16-07 ..... | 634 | 33-146-28-07 ..... | 638 |
| 32-114-03-01 ..... | 600 | 32-302-12-01 ..... | 610      | 32-460-10-01 ..... | 617 | 32-920-19-07 ..... | 634 | 33-149-36-07 ..... | 638 |
| 32-116-01-01 ..... | 600 | 32-302-14-07 ..... | 609, 610 | 32-460-12-01 ..... | 617 | 32-920-20-07 ..... | 634 | 33-195-41-07 ..... | 639 |
| 32-116-02-01 ..... | 600 | 32-310-22-01 ..... | 611      | 32-460-14-01 ..... | 617 | 32-920-21-07 ..... | 634 | 33-198-44-07 ..... | 639 |
| 32-116-03-01 ..... | 600 | 32-310-90-98 ..... | 611      | 32-460-16-01 ..... | 617 | 32-920-23-07 ..... | 634 | 33-300-21-07 ..... | 640 |
| 32-120-01-01 ..... | 600 | 32-314-24-02 ..... | 612      | 32-460-18-01 ..... | 617 | 32-920-25-07 ..... | 634 | 33-309-28-07 ..... | 640 |
| 32-120-02-01 ..... | 600 | 32-314-99-02 ..... | 612      | 32-460-20-01 ..... | 617 | 32-920-30-07 ..... | 634 | 33-328-27-07 ..... | 640 |
| 32-120-03-01 ..... | 600 | 32-323-20-07 ..... | 612      | 32-460-82-01 ..... | 617 | 32-920-35-07 ..... | 634 | 33-329-27-07 ..... | 640 |
| 32-128-01-01 ..... | 601 | 32-323-25-07 ..... | 612      | 32-583-32-01 ..... | 618 | 32-920-40-07 ..... | 634 | 33-344-01-07 ..... | 640 |
| 32-128-02-01 ..... | 601 | 32-323-30-07 ..... | 612      | 32-584-32-02 ..... | 618 | 32-921-05-07 ..... | 634 | 33-344-02-07 ..... | 640 |
| 32-128-03-01 ..... | 601 | 32-323-35-07 ..... | 612      | 32-593-25-01 ..... | 618 | 32-921-06-07 ..... | 634 | 33-345-01-07 ..... | 640 |
| 32-130-01-01 ..... | 601 | 32-323-40-07 ..... | 612      | 32-595-26-07 ..... | 618 | 32-921-07-07 ..... | 634 | 33-345-02-07 ..... | 640 |
| 32-130-02-01 ..... | 601 | 32-324-20-07 ..... | 612      | 32-622-25-07 ..... | 619 | 32-921-08-07 ..... | 634 | 33-382-01-07 ..... | 641 |
| 32-130-03-01 ..... | 601 | 32-324-25-07 ..... | 612      | 32-628-25-07 ..... | 619 | 32-921-09-07 ..... | 634 | 33-382-02-07 ..... | 641 |
| 32-132-01-01 ..... | 601 | 32-324-30-07 ..... | 612      | 32-645-28-07 ..... | 619 | 32-921-11-07 ..... | 634 | 33-382-03-07 ..... | 641 |
| 32-132-02-01 ..... | 601 | 32-324-35-07 ..... | 612      | 32-659-26-07 ..... | 619 | 32-921-12-07 ..... | 634 | 33-386-30-07 ..... | 642 |
| 32-133-01-07 ..... | 601 | 32-324-40-07 ..... | 612      | 32-663-24-07 ..... | 620 | 32-921-14-07 ..... | 634 | 33-465-09-07 ..... | 642 |
| 32-160-01-01 ..... | 602 | 32-325-40-07 ..... | 612      | 32-682-24-07 ..... | 620 | 32-921-15-07 ..... | 634 |                    |     |
| 32-160-02-01 ..... | 602 | 32-342-24-01 ..... | 612      | 32-683-24-07 ..... | 620 | 32-921-16-07 ..... | 634 | <b>35</b>          |     |
| 32-160-03-01 ..... | 602 | 32-381-24-07 ..... | 613      | 32-697-23-07 ..... | 620 | 32-921-19-07 ..... | 634 | 35-133-06-07 ..... | 644 |
| 32-165-01-07 ..... | 602 | 32-383-24-07 ..... | 613      | 32-699-26-07 ..... | 621 | 32-921-20-07 ..... | 634 | 35-133-07-07 ..... | 644 |
| 32-165-02-07 ..... | 602 | 32-400-01-01 ..... | 614      | 32-702-24-07 ..... | 621 | 32-921-21-07 ..... | 634 | 35-133-09-07 ..... | 644 |
| 32-165-03-07 ..... | 602 | 32-400-02-01 ..... | 614      | 32-704-24-07 ..... | 621 | 32-921-23-07 ..... | 634 | 35-134-09-07 ..... | 644 |
| 32-182-01-01 ..... | 603 | 32-400-03-01 ..... | 614      | 32-706-24-07 ..... | 621 | 32-921-25-07 ..... | 634 | 35-134-18-07 ..... | 644 |
| 32-182-02-01 ..... | 603 | 32-400-04-01 ..... | 614      | 32-728-21-07 ..... | 621 | 32-921-30-07 ..... | 634 | 35-224-00-18 ..... | 645 |
| 32-182-03-01 ..... | 603 | 32-400-05-01 ..... | 614      | 32-734-26-07 ..... | 622 | 32-921-35-07 ..... | 634 | 35-224-01-18 ..... | 645 |
| 32-183-01-01 ..... | 603 | 32-400-06-01 ..... | 614      | 32-738-16-07 ..... | 622 | 32-921-40-07 ..... | 634 | 35-224-12-18 ..... | 645 |
| 32-183-02-01 ..... | 603 | 32-400-07-01 ..... | 614      | 32-740-21-07 ..... | 622 | 32-924-10-07 ..... | 636 | 35-224-23-18 ..... | 645 |
| 32-183-03-01 ..... | 603 | 32-400-08-01 ..... | 614      | 32-741-32-07 ..... | 623 | 32-924-12-07 ..... | 636 | 35-224-34-18 ..... | 645 |
| 32-185-01-01 ..... | 603 | 32-400-09-01 ..... | 614      | 32-744-27-07 ..... | 623 | 32-924-14-07 ..... | 636 | 35-224-45-18 ..... | 645 |
| 32-185-02-01 ..... | 603 | 32-400-10-01 ..... | 614      | 32-745-25-07 ..... | 623 | 32-926-05-07 ..... | 634 | 35-224-56-18 ..... | 645 |
| 32-185-03-01 ..... | 603 | 32-400-11-01 ..... | 614      | 32-758-17-07 ..... | 624 | 32-926-06-07 ..... | 634 | 35-224-67-18 ..... | 645 |
| 32-190-01-01 ..... | 604 | 32-400-12-01 ..... | 614      | 32-760-17-07 ..... | 624 | 32-926-07-07 ..... | 634 | 35-224-78-18 ..... | 645 |
| 32-190-02-01 ..... | 604 | 32-400-13-01 ..... | 614      | 32-762-27-07 ..... | 624 | 32-926-08-07 ..... | 634 | 35-224-99-18 ..... | 645 |
| 32-191-01-01 ..... | 604 | 32-400-14-01 ..... | 614      | 32-773-27-07 ..... | 625 | 32-926-09-07 ..... | 634 | 35-226-00-18 ..... | 645 |
| 32-191-02-01 ..... | 604 | 32-400-15-01 ..... | 614      | 32-779-23-07 ..... | 625 | 32-926-11-07 ..... | 634 | 35-226-01-18 ..... | 645 |
| 32-195-01-01 ..... | 604 | 32-400-16-01 ..... | 614      | 32-793-25-07 ..... | 625 | 32-926-12-07 ..... | 634 | 35-226-12-18 ..... | 645 |
| 32-195-02-01 ..... | 604 | 32-400-17-01 ..... | 614      | 32-804-03-07 ..... | 626 | 32-926-14-07 ..... | 634 | 35-226-23-18 ..... | 645 |
| 32-196-01-01 ..... | 605 | 32-400-18-01 ..... | 614      | 32-806-22-07 ..... | 626 | 32-926-15-07 ..... | 634 | 35-226-34-18 ..... | 645 |
| 32-196-02-01 ..... | 605 | 32-400-19-01 ..... | 614      | 32-825-23-01 ..... | 627 | 32-926-16-07 ..... | 634 | 35-226-45-18 ..... | 645 |
| 32-196-03-01 ..... | 605 | 32-400-20-01 ..... | 614      | 32-827-30-07 ..... | 627 | 32-926-19-07 ..... | 634 | 35-226-56-18 ..... | 645 |
| 32-197-01-01 ..... | 605 | 32-400-21-01 ..... | 614      | 32-829-27-07 ..... | 627 | 32-926-20-07 ..... | 634 | 35-226-67-18 ..... | 645 |
| 32-197-02-01 ..... | 605 | 32-400-22-01 ..... | 614      | 32-841-23-07 ..... | 628 | 32-926-21-07 ..... | 634 | 35-226-78-18 ..... | 645 |
| 32-197-03-01 ..... | 605 | 32-400-23-01 ..... | 614      | 32-843-21-07 ..... | 628 | 32-926-23-07 ..... | 634 |                    |     |
| 32-199-01-01 ..... | 605 | 32-400-24-01 ..... | 614      | 32-846-21-07 ..... | 628 | 32-926-25-07 ..... | 634 | <b>36</b>          |     |
| 32-199-02-01 ..... | 605 | 32-400-25-01 ..... | 614      | 32-846-28-07 ..... | 628 | 32-926-30-07 ..... | 634 | 36-001-01-07 ..... | 648 |
| 32-199-03-01 ..... | 605 | 32-400-26-01 ..... | 614      | 32-851-22-07 ..... | 629 | 32-926-35-07 ..... | 634 | 36-001-01-14 ..... | 648 |
| 32-202-01-01 ..... | 606 | 32-400-80-01 ..... | 614      | 32-851-24-07 ..... | 629 | 32-926-40-07 ..... | 634 | 36-001-06-07 ..... | 648 |
| 32-202-02-01 ..... | 606 | 32-400-90-01 ..... | 614      | 32-853-26-07 ..... | 629 | 32-927-05-07 ..... | 634 | 36-001-06-14 ..... | 648 |
| 32-202-03-01 ..... | 606 | 32-401-01-01 ..... | 614      | 32-855-24-07 ..... | 630 | 32-927-06-07 ..... | 634 | 36-001-07-07 ..... | 648 |
| 32-203-01-01 ..... | 606 | 32-401-02-01 ..... | 614      | 32-855-25-07 ..... | 630 | 32-927-07-07 ..... | 634 | 36-001-07-14 ..... | 648 |
| 32-203-02-01 ..... | 606 | 32-401-03-01 ..... | 614      | 32-857-28-07 ..... | 631 | 32-927-08-07 ..... | 634 | 36-001-08-07 ..... | 648 |
| 32-203-03-01 ..... | 606 | 32-401-04-01 ..... | 614      | 32-859-32-07 ..... | 631 | 32-927-09-07 ..... | 634 | 36-001-08-14 ..... | 648 |
| 32-205-01-01 ..... | 606 | 32-401-05-01 ..... | 614      | 32-861-02-07 ..... | 631 | 32-927-11-07 ..... | 634 | 36-001-09-07 ..... | 648 |
| 32-205-02-01 ..... | 606 | 32-401-06-01 ..... | 614      | 32-865-00-07 ..... | 632 | 32-927-12-07 ..... | 634 | 36-001-09-14 ..... | 648 |
| 32-205-03-01 ..... | 606 | 32-401-07-01 ..... | 614      | 32-865-01-07 ..... | 632 | 32-927-14-07 ..... | 634 | 36-001-11-07 ..... | 649 |
| 32-232-01-01 ..... | 607 | 32-401-08-01 ..... | 614      | 32-866-22-07 ..... | 632 | 32-927-15-07 ..... | 634 | 36-001-11-14 ..... | 649 |
| 32-232-02-01 ..... | 607 | 32-401-09-01 ..... | 614      | 32-866-28-07 ..... | 632 | 32-927-16-07 ..... | 634 | 36-001-16-07 ..... | 649 |
| 32-233-01-01 ..... | 607 | 32-401-10-01 ..... | 614      | 32-900-01-07 ..... | 633 | 32-927-19-07 ..... | 634 | 36-001-16-14 ..... | 649 |
| 32-233-02-01 ..... | 607 | 32-401-11-01 ..... | 614      | 32-900-02-07 ..... | 633 | 32-927-20-07 ..... | 634 | 36-001-21-07 ..... | 650 |
| 32-235-01-01 ..... | 607 | 32-401-12-01 ..... | 614      | 32-900-03-07 ..... | 633 | 32-927-21-07 ..... | 634 | 36-001-21-14 ..... | 650 |
| 32-235-02-01 ..... | 607 | 32-401-13-01 ..... | 614      | 32-900-04-07 ..... | 633 | 32-927-23-07 ..... | 634 | 36-001-26-07 ..... | 651 |
| 32-249-01-01 ..... | 608 | 32-401-14-01 ..... | 614      | 32-900-05-07 ..... | 633 | 32-927-25-07 ..... | 634 | 36-001-26-14 ..... | 651 |
| 32-249-02-01 ..... | 608 | 32-401-15-01 ..... | 614      | 32-900-06-07 ..... | 633 | 32-927-30-07 ..... | 634 | 36-003-01-07 ..... | 652 |
| 32-249-03-01 ..... | 608 | 32-401-16-01 ..... | 614      | 32-906-01-07 ..... | 633 | 32-927-35-07 ..... | 634 | 36-003-01-14 ..... | 652 |
| 32-250-01-01 ..... | 608 | 32-401-17-01 ..... | 614      | 32-906-02-07 ..... | 633 | 32-927-40-07 ..... | 634 | 36-003-02-07 ..... | 652 |
| 32-250-02-01 ..... | 608 | 32-430-02-01 ..... | 615      | 32-906-03-07 ..... | 633 | 32-989-03-01 ..... | 636 | 36-003-02-14 ..... | 652 |
| 32-250-03-01 ..... | 608 | 32-430-04-01 ..... | 615      | 32-906-04-07 ..... | 633 | 32-989-04-01 ..... | 636 | 36-003-03-07 ..... | 652 |
| 32-250-04-01 ..... | 608 | 32-430-06-01 ..... | 615      | 32-906-05-07 ..... | 633 | 32-989-06-01 ..... | 636 | 36-003-03-14 ..... | 652 |
| 32-251-01-01 ..... | 608 | 32-430-08-01 ..... | 615      | 32-906-06-07 ..... | 633 | 32-989-08-01 ..... | 636 | 36-003-04-07 ..... | 652 |
| 32-251-02-01 ..... | 608 | 32-430-10-01 ..... | 615      | 32-919-00-07 ..... | 633 | 32-989-10-01 ..... | 636 | 36-003-04-14 ..... | 652 |
| 32-251-03-01 ..... | 608 | 32-430-12-01 ..... | 615      | 32-920-05-07 ..... | 634 | 32-989-12-01 ..... | 636 | 36-003-11-07 ..... | 653 |
| 32-252-01-01 ..... | 608 | 32-430-14-01 ..... | 615      | 32-920-06-07 ..... | 634 | 32-989-14-01 ..... | 636 | 36-003-11-14 ..... | 653 |
| 32-252-02-01 ..... | 608 | 32-430-16-01 ..... | 615      | 32-920-07-07 ..... | 634 | 32-989-50-01 ..... | 636 | 36-003-12-07 ..... | 653 |
| 32-302-00-01 ..... | 610 | 32-430-18-01 ..... | 615      | 32-920-08-07 ..... | 634 |                    |     | 36-003-12-14 ..... | 653 |
| 32-302-01-01 ..... | 609 | 32-430-20-01 ..... | 615      | 32-920-09-07 ..... | 634 | <b>33</b>          |     | 36-003-13-07 ..... | 653 |
| 32-302-02-01 ..... | 609 | 32-430-22-01 ..... | 615      | 32-920-11-07 ..... | 634 | 33-103-34-07 ..... | 638 | 36-003-13-14 ..... | 653 |
| 32-302-03-01 ..... | 609 | 32-430-24-01 ..... | 615      | 32-920-12-07 ..... | 634 | 33-141-36-07 ..... | 638 | 36-003-14-07 ..... | 653 |
| 32-302-04-01 ..... | 609 | 32-430-26-01 ..... | 615      | 32-920-14-07 ..... | 634 | 33-141-40-07 ..... | 638 | 36-003-14-14 ..... | 653 |
| 32-302-05-01 ..... | 609 | 32-430-80-01 ..... | 615      | 32-920-15-07 ..... | 634 | 33-145-30-07 ..... | 638 | 36-005-01-07 ..... | 654 |

# Nummern-Index

Index of order numbers

Índice de números de referencia

Index numérique des références de commande

Elenco dei codici

|                       |                       |                       |                       |                       |
|-----------------------|-----------------------|-----------------------|-----------------------|-----------------------|
| 36-005-01-14 .....654 | 36-030-13-07 .....662 | 36-358-40-01 .....670 | 36-845-03-07 .....680 | 37-389-00-07 .....698 |
| 36-005-02-07 .....654 | 36-030-20-07 .....662 | 36-371-11-07 .....671 | 36-848-13-07 .....681 | 37-389-01-07 .....698 |
| 36-005-02-14 .....654 | 36-030-30-07 .....662 | 36-375-12-07 .....671 | 36-849-13-07 .....681 | 37-389-02-07 .....698 |
| 36-005-03-07 .....654 | 36-036-01-07 .....662 | 36-381-13-07 .....671 | 36-852-13-07 .....681 | 37-389-03-07 .....698 |
| 36-005-03-14 .....654 | 36-036-02-07 .....662 | 36-391-14-07 .....671 | 36-856-01-07 .....681 | 37-440-01-07 .....699 |
| 36-005-04-07 .....654 | 36-036-05-07 .....662 | 36-395-16-07 .....671 | 36-856-02-07 .....681 | 37-441-01-07 .....699 |
| 36-005-04-14 .....654 | 36-036-06-07 .....662 | 36-395-20-07 .....671 | 36-856-03-07 .....681 | 37-444-16-07 .....699 |
| 36-005-51-07 .....655 | 36-036-23-07 .....662 | 36-405-12-07 .....672 | 36-856-04-07 .....681 | 37-459-16-07 .....699 |
| 36-005-51-14 .....655 | 36-038-01-07 .....663 | 36-407-14-07 .....672 | 36-858-14-07 .....682 | 37-466-15-07 .....699 |
| 36-005-52-07 .....655 | 36-038-02-07 .....663 | 36-416-11-07 .....672 | 36-859-35-07 .....682 | 37-468-15-07 .....699 |
| 36-005-52-14 .....655 | 36-038-03-07 .....663 | 36-425-08-07 .....673 | 36-859-50-07 .....682 | 37-484-15-07 .....700 |
| 36-005-53-07 .....655 | 36-044-01-07 .....663 | 36-427-08-07 .....673 | 36-859-75-07 .....682 | 37-497-19-07 .....700 |
| 36-005-53-14 .....655 | 36-044-02-07 .....663 | 36-430-08-07 .....673 | 36-859-90-07 .....682 | 37-499-19-07 .....700 |
| 36-005-54-07 .....655 | 36-044-03-07 .....663 | 36-430-14-07 .....673 | 36-861-45-07 .....683 | 37-504-03-07 .....700 |
| 36-005-54-14 .....655 | 36-112-03-01 .....664 | 36-442-81-07 .....673 | 36-861-75-07 .....683 | 37-504-04-07 .....700 |
| 36-010-11-07 .....656 | 36-112-10-01 .....664 | 36-442-82-07 .....673 | 36-885-26-07 .....684 | 37-504-05-07 .....700 |
| 36-010-11-14 .....656 | 36-112-11-01 .....664 | 36-442-83-07 .....673 | 36-887-26-07 .....684 | 37-505-03-07 .....700 |
| 36-010-12-07 .....656 | 36-112-12-01 .....664 | 36-445-08-07 .....673 | 36-898-30-11 .....684 | 37-505-04-07 .....700 |
| 36-010-12-14 .....656 | 36-112-13-01 .....664 | 36-448-08-07 .....673 | 36-898-40-11 .....684 | 37-505-05-07 .....700 |
| 36-011-01-07 .....657 | 36-112-14-01 .....664 | 36-456-08-07 .....673 | 36-899-12-01 .....684 | 37-521-04-07 .....701 |
| 36-011-01-14 .....657 | 36-114-03-01 .....664 | 36-461-17-07 .....674 |                       | 37-521-05-07 .....701 |
| 36-011-02-07 .....657 | 36-115-04-01 .....664 | 36-463-19-07 .....675 | <b>37</b>             | 37-525-16-07 .....701 |
| 36-011-02-14 .....657 | 36-118-03-01 .....664 | 36-466-14-07 .....675 | 37-101-15-07 .....686 | 37-531-16-07 .....701 |
| 36-011-06-07 .....657 | 36-118-11-01 .....664 | 36-493-01-07 .....676 | 37-105-18-07 .....686 | 37-541-19-07 .....701 |
| 36-011-06-14 .....657 | 36-118-12-01 .....664 | 36-493-02-07 .....676 | 37-115-16-07 .....686 | 37-543-19-07 .....701 |
| 36-011-07-07 .....657 | 36-118-13-01 .....664 | 36-495-02-07 .....676 | 37-115-20-07 .....686 | 37-544-01-07 .....701 |
| 36-011-07-14 .....657 | 36-118-14-01 .....664 | 36-495-10-07 .....676 | 37-121-20-07 .....686 | 37-544-02-07 .....701 |
| 36-013-01-07 .....658 | 36-119-04-01 .....664 | 36-495-11-07 .....676 | 37-129-20-07 .....686 | 37-545-18-07 .....702 |
| 36-013-01-14 .....658 | 36-134-01-07 .....665 | 36-495-12-07 .....676 | 37-145-20-07 .....686 | 37-546-18-07 .....702 |
| 36-020-06-07 .....659 | 36-134-02-07 .....665 | 36-497-01-07 .....676 | 37-207-18-07 .....687 | 37-547-20-07 .....702 |
| 36-020-11-07 .....659 | 36-134-03-07 .....665 | 36-497-02-07 .....676 | 37-213-18-07 .....687 | 37-549-22-07 .....702 |
| 36-020-16-07 .....659 | 36-134-04-07 .....665 | 36-497-10-07 .....676 | 37-215-01-07 .....687 | 37-550-19-07 .....703 |
| 36-020-21-07 .....659 | 36-134-05-07 .....665 | 36-497-11-07 .....676 | 37-227-01-07 .....687 | 37-557-22-07 .....703 |
| 36-022-01-07 .....659 | 36-134-06-07 .....665 | 36-497-12-07 .....676 | 37-227-02-07 .....687 | 37-559-23-07 .....703 |
| 36-022-02-07 .....659 | 36-134-07-07 .....665 | 36-497-13-07 .....676 | 37-227-03-07 .....687 | 37-560-18-07 .....703 |
| 36-022-03-07 .....659 | 36-148-12-01 .....665 | 36-497-14-07 .....676 | 37-227-04-07 .....687 | 37-562-22-07 .....703 |
| 36-022-04-07 .....659 | 36-170-07-04 .....666 | 36-498-01-07 .....676 | 37-235-12-07 .....688 | 37-568-21-07 .....704 |
| 36-022-05-07 .....659 | 36-172-08-04 .....666 | 36-498-02-07 .....676 | 37-237-12-07 .....688 | 37-572-19-07 .....704 |
| 36-022-06-07 .....659 | 36-174-09-04 .....666 | 36-498-10-07 .....676 | 37-241-10-07 .....689 | 37-579-22-07 .....704 |
| 36-022-07-07 .....659 | 36-175-10-04 .....666 | 36-498-11-07 .....676 | 37-241-12-07 .....689 | 37-581-22-07 .....704 |
| 36-024-01-07 .....660 | 36-177-11-04 .....666 | 36-498-12-07 .....676 | 37-249-12-07 .....689 | 37-583-21-07 .....704 |
| 36-024-02-07 .....660 | 36-180-10-04 .....667 | 36-498-13-07 .....676 | 37-255-01-07 .....690 | 37-584-21-07 .....704 |
| 36-024-03-07 .....660 | 36-182-11-04 .....667 | 36-498-14-07 .....676 | 37-255-02-07 .....690 | 37-585-16-07 .....704 |
| 36-024-04-07 .....660 | 36-184-12-04 .....667 | 36-532-15-07 .....677 | 37-255-03-07 .....690 | 37-593-16-07 .....705 |
| 36-024-06-07 .....660 | 36-186-13-04 .....667 | 36-543-12-07 .....677 | 37-255-04-07 .....690 | 37-594-16-07 .....705 |
| 36-024-07-07 .....660 | 36-188-14-04 .....667 | 36-551-01-07 .....677 | 37-255-05-07 .....690 | 37-595-15-07 .....705 |
| 36-024-08-07 .....660 | 36-189-10-04 .....667 | 36-554-01-07 .....677 | 37-256-01-07 .....690 | 37-597-02-07 .....705 |
| 36-024-11-07 .....660 | 36-192-11-04 .....667 | 36-554-02-07 .....677 | 37-256-02-07 .....690 | 37-597-04-07 .....705 |
| 36-024-12-07 .....660 | 36-194-12-04 .....667 | 36-554-03-07 .....677 | 37-256-03-07 .....690 | 37-597-06-07 .....705 |
| 36-024-13-07 .....660 | 36-196-13-04 .....667 | 36-563-16-07 .....677 | 37-256-04-07 .....690 | 37-597-08-07 .....705 |
| 36-024-14-07 .....660 | 36-198-14-04 .....667 | 36-570-16-07 .....677 | 37-258-01-07 .....690 | 37-601-16-07 .....705 |
| 36-024-15-07 .....660 | 36-200-15-04 .....667 | 36-577-01-07 .....677 | 37-258-02-07 .....690 | 37-605-16-07 .....705 |
| 36-024-16-07 .....660 | 36-210-10-04 .....668 | 36-577-02-07 .....677 | 37-258-03-07 .....690 | 37-606-04-07 .....706 |
| 36-024-17-07 .....660 | 36-212-11-04 .....668 | 36-577-03-07 .....677 | 37-258-04-07 .....690 | 37-606-07-07 .....706 |
| 36-024-21-07 .....660 | 36-214-12-04 .....668 | 36-585-01-07 .....678 | 37-285-01-07 .....691 | 37-606-09-07 .....706 |
| 36-024-22-07 .....660 | 36-216-13-04 .....668 | 36-585-02-07 .....678 | 37-308-01-07 .....692 | 37-606-12-07 .....706 |
| 36-024-23-07 .....660 | 36-216-90-98 .....668 | 36-585-03-07 .....678 | 37-308-02-07 .....692 | 37-607-06-07 .....706 |
| 36-024-24-07 .....660 | 36-218-14-04 .....668 | 36-585-04-07 .....678 | 37-308-03-07 .....692 | 37-608-02-07 .....706 |
| 36-024-25-07 .....660 | 36-220-15-04 .....668 | 36-585-05-07 .....678 | 37-309-01-07 .....693 | 37-608-04-07 .....706 |
| 36-024-26-07 .....660 | 36-221-10-04 .....668 | 36-585-06-07 .....678 | 37-309-02-07 .....693 | 37-608-07-07 .....706 |
| 36-024-27-07 .....660 | 36-221-91-98 .....668 | 36-585-07-07 .....678 | 37-309-03-07 .....693 | 37-608-09-07 .....706 |
| 36-024-31-07 .....660 | 36-222-10-04 .....668 | 36-589-01-07 .....678 | 37-309-04-07 .....693 | 37-608-12-07 .....706 |
| 36-024-32-07 .....660 | 36-223-11-04 .....668 | 36-589-02-07 .....678 | 37-323-19-07 .....694 | 37-609-06-07 .....706 |
| 36-025-01-07 .....661 | 36-223-90-98 .....668 | 36-630-16-07 .....678 | 37-327-19-07 .....694 | 37-610-16-07 .....706 |
| 36-025-02-07 .....661 | 36-224-10-04 .....669 | 36-655-16-07 .....678 | 37-331-20-07 .....694 | 37-612-16-07 .....706 |
| 36-025-03-07 .....661 | 36-224-90-98 .....669 | 36-657-16-07 .....678 | 37-334-21-07 .....694 | 37-616-10-07 .....707 |
| 36-025-06-07 .....661 | 36-224-91-98 .....669 | 36-661-18-07 .....678 | 37-335-01-07 .....695 | 37-616-12-07 .....707 |
| 36-025-07-07 .....661 | 36-224-92-98 .....669 | 36-663-18-07 .....678 | 37-335-20-07 .....695 | 37-616-14-07 .....707 |
| 36-025-08-07 .....661 | 36-224-93-98 .....669 | 36-737-20-07 .....679 | 37-335-21-07 .....695 | 37-620-03-07 .....707 |
| 36-027-01-07 .....661 | 36-226-00-04 .....669 | 36-739-17-07 .....679 | 37-337-21-07 .....695 | 37-620-04-07 .....707 |
| 36-027-02-07 .....661 | 36-230-59-04 .....669 | 36-743-10-07 .....679 | 37-340-13-07 .....696 | 37-622-03-07 .....707 |
| 36-027-11-07 .....661 | 36-234-61-04 .....669 | 36-743-20-07 .....679 | 37-341-13-07 .....696 | 37-622-04-07 .....707 |
| 36-027-12-07 .....661 | 36-234-90-98 .....669 | 36-743-30-07 .....679 | 37-342-12-07 .....696 | 37-622-07-07 .....707 |
| 36-029-01-07 .....661 | 36-316-11-07 .....670 | 36-743-40-07 .....679 | 37-343-12-07 .....696 | 37-622-09-07 .....707 |
| 36-029-06-07 .....661 | 36-321-01-01 .....670 | 36-743-50-07 .....679 | 37-356-17-07 .....697 | 37-622-12-07 .....707 |
| 36-030-06-07 .....662 | 36-321-02-01 .....670 | 36-817-01-01 .....680 | 37-357-17-07 .....697 | 37-623-04-07 .....707 |
| 36-030-07-07 .....662 | 36-321-03-01 .....670 | 36-817-02-01 .....680 | 37-360-17-07 .....697 | 37-623-05-07 .....707 |
| 36-030-08-07 .....662 | 36-351-16-07 .....670 | 36-817-03-01 .....680 | 37-361-17-07 .....697 | 37-623-06-07 .....707 |
| 36-030-11-07 .....662 | 36-353-16-07 .....670 | 36-845-01-07 .....680 | 37-362-03-07 .....697 | 37-623-07-07 .....707 |
| 36-030-12-07 .....662 | 36-358-30-01 .....670 | 36-845-02-07 .....680 | 37-362-05-07 .....697 | 37-624-10-07 .....708 |

## Nummern-Index

Index of order numbers

Índice de números de referencia

Index numérique des références de commande

Elenco dei codici

## Index

Index

Indice

Index

Indice

i

37-624-12-07 .....708  
37-624-14-07 .....708  
37-624-16-07 .....708  
37-625-01-07 .....708  
37-625-02-07 .....708  
37-625-03-07 .....708  
37-628-01-07 .....708  
37-628-02-07 .....708  
37-628-03-07 .....708  
37-632-20-07 .....709  
37-634-20-07 .....709  
37-649-00-07 .....709  
37-649-01-07 .....709  
37-649-02-07 .....709  
37-652-00-07 .....710  
37-656-01-07 .....711  
37-656-02-07 .....711  
37-658-01-07 .....711  
37-670-21-07 .....711  
37-671-21-07 .....712  
37-673-21-07 .....712  
37-674-18-07 .....712  
37-676-18-07 .....712  
37-680-01-07 .....713  
37-680-02-07 .....713  
37-680-03-07 .....713  
37-680-04-07 .....713  
37-680-05-07 .....713  
37-680-06-07 .....713  
37-680-07-07 .....713  
37-680-08-07 .....713  
37-680-09-07 .....713  
37-680-10-07 .....713  
37-680-21-07 .....712  
37-682-01-07 .....714  
37-682-02-07 .....714  
37-682-03-07 .....714  
37-682-04-07 .....714  
37-682-05-07 .....714  
37-682-06-07 .....714  
37-684-15-07 .....715  
37-686-16-07 .....715  
37-687-17-07 .....715  
37-688-01-07 .....715  
37-688-02-07 .....715  
37-688-03-07 .....715  
37-692-22-07 .....715  
37-694-17-07 .....715  
37-697-19-07 .....715  
37-698-10-07 .....716  
37-699-11-07 .....716  
37-700-12-07 .....716  
37-702-15-07 .....716  
37-704-02-07 .....716  
37-704-05-07 .....716  
37-704-07-07 .....716  
37-704-10-07 .....716  
37-706-16-07 .....716  
37-707-20-07 .....717  
37-708-14-07 .....717  
37-709-01-07 .....717  
37-709-02-07 .....717  
37-710-14-07 .....717  
37-712-16-07 .....717  
37-713-15-07 .....717  
37-714-15-07 .....717  
37-715-14-07 .....717  
37-721-20-07 .....718  
37-724-01-07 .....718  
37-724-02-07 .....718  
37-724-03-07 .....718  
37-725-23-07 .....718  
37-728-11-07 .....719  
37-731-14-07 .....719  
37-732-10-07 .....719  
37-742-21-07 .....719  
37-748-01-07 .....719  
37-748-02-07 .....719  
37-748-03-07 .....719  
37-748-04-07 .....719

37-748-05-07 .....719  
37-748-06-07 .....719  
37-755-01-07 .....720  
37-755-02-07 .....720  
37-755-03-07 .....720  
37-755-04-07 .....720  
37-755-05-07 .....720  
37-755-06-07 .....720  
37-756-01-07 .....720  
37-756-02-07 .....720  
37-756-03-07 .....720  
37-756-04-07 .....720  
37-756-05-07 .....720  
37-756-06-07 .....720  
37-814-30-07 .....720  
37-840-20-01 .....720  
37-840-90-98 .....720  
37-842-30-07 .....720  
37-842-40-07 .....720

### 39

39-581-01-07 .....632  
39-584-20-07 .....632  
39-584-30-07 .....632  
39-584-40-07 .....632

### 54

54-100-01-04 .....742  
54-150-10-01 .....742  
54-150-20-01 .....743  
54-155-25-04 .....743  
54-301-10-07 .....744  
54-305-10-07 .....744  
54-331-14-07 .....744  
54-336-14-07 .....744  
54-347-13-07 .....744  
54-360-13-07 .....745  
54-373-10-07 .....745  
54-378-10-07 .....745  
54-379-10-07 .....745  
54-386-10-07 .....745  
54-389-16-04 .....745  
54-406-00-04 .....746

### 55

55-085-27-07 .....750  
55-091-30-07 .....750  
55-162-20-01 .....751  
55-164-20-01 .....751  
55-302-50-01 .....751  
55-302-65-01 .....751  
55-302-75-01 .....751  
55-309-65-01 .....752  
55-310-65-01 .....752  
55-335-02-01 .....752  
55-337-02-01 .....753  
55-348-00-01 .....753  
55-348-01-01 .....753  
55-358-25-01 .....754  
55-358-32-01 .....754  
55-805-14-01 .....754  
55-808-14-01 .....754

### 56

56-231-04-01 .....757  
56-231-06-01 .....757  
56-231-08-01 .....757  
56-231-11-01 .....757  
56-231-12-01 .....757  
56-231-14-01 .....757  
56-231-16-01 .....757  
56-231-18-01 .....757  
56-235-11-01 .....757  
56-235-12-01 .....757  
56-235-14-01 .....757  
56-235-16-01 .....757  
56-235-18-01 .....757  
56-254-01-01 .....757  
56-256-02-01 .....757  
56-256-05-01 .....757

56-256-10-01 .....757  
56-256-20-01 .....757  
56-321-23-01 .....758  
56-321-30-01 .....758  
56-321-31-01 .....758  
56-321-35-01 .....758  
56-321-40-01 .....758  
56-324-21-01 .....758  
56-324-24-01 .....758  
56-324-30-01 .....758  
56-324-31-01 .....758  
56-324-35-01 .....758  
56-324-40-01 .....758  
56-324-42-01 .....758  
56-340-23-01 .....758  
56-348-22-01 .....758  
56-360-30-01 .....759  
56-360-50-01 .....759  
56-360-51-01 .....759  
56-360-52-01 .....759  
56-360-75-01 .....759  
56-360-76-01 .....759  
56-360-77-01 .....759  
56-360-98-01 .....759  
56-360-99-01 .....759  
56-411-16-01 .....759  
56-411-20-01 .....759  
56-411-21-01 .....759  
56-411-23-01 .....759  
56-411-26-01 .....759  
56-411-27-01 .....759  
56-411-30-01 .....759  
56-411-33-01 .....759  
56-419-20-01 .....759  
56-431-06-01 .....760  
56-431-10-01 .....760  
56-432-08-01 .....760  
56-432-12-01 .....760  
56-435-15-01 .....760  
56-673-17-01 .....760  
56-673-25-01 .....760  
56-673-27-01 .....760

### 73

73-101-00-04 .....762  
73-101-01-04 .....762, 763  
73-101-02-04 .....763  
73-101-03-04 .....763  
73-101-04-04 .....763  
73-101-05-04 .....763  
73-101-06-04 .....763  
73-101-07-04 .....763  
73-101-08-04 .....763  
73-101-09-04 .....762, 763  
73-101-20-04 .....762  
73-102-02-04 .....763  
73-102-03-04 .....763  
73-301-03-04 .....764  
73-303-03-04 .....764  
73-304-07-04 .....764  
73-306-08-04 .....764  
73-306-12-04 .....764  
73-306-13-04 .....764  
73-306-15-04 .....764  
73-308-20-04 .....764  
73-308-25-04 .....764  
73-308-30-04 .....764  
73-315-00-04 .....765  
73-318-12-04 .....765  
73-318-15-04 .....765  
73-318-30-04 .....765  
73-318-50-04 .....765  
73-324-35-04 .....766  
73-326-40-04 .....766  
73-327-60-04 .....766  
73-333-80-04 .....766  
73-335-60-04 .....766  
73-340-75-04 .....766  
73-351-50-04 .....766  
73-356-15-04 .....767

73-359-18-04 .....767  
73-361-15-04 .....767  
73-365-08-04 .....767  
73-367-16-04 .....767  
73-370-95-04 .....767  
73-454-15-01 .....768  
73-470-58-07 .....768  
73-474-55-07 .....768



---

Index, alphabetisch  
**Deutsch**



|  |                   |  |                   |
|--|-------------------|--|-------------------|
| <b>A</b>                                   |                   |  |                   |
| Abfallerimer                               | 768               | Arterienklemme, Rochester-Carmalt      | 177               |
| Abfallzange, Martin                        | 768               | Arterienklemme, Spencer-Wells          | 167               |
| Abfallzange, Sauerbruch                    | 768               | Arterienklemme, Tuffier                | 168               |
| Abortuskürette, Pestalozza                 | 642               | Asch, Septumrichtzange                 | 718               |
| Abortuslöffel, Cuzzi                       | 641               | Aston, Face-lift Schere                | 45                |
| Abortuszange, Sänger                       | 640               | Atraumatische Mikropinzette            | 151               |
| Abortuszange, Winter                       | 640               | Atraumatische Pinzette                 | 130               |
| Absaugkürette                              | 636               | Atraumatische Pinzette, DeBakey        | 135-136           |
| Adlerkreuz, Chirurgische Pinzette          | 139               | Atraumatische Pinzette, Gerald         | 136               |
| Adson, Anatomische Pinzette                | 128, 132          | Atriumhaken, Cooley                    | 271               |
| Adson, Chirurgische Pinzette               | 132, 140          | Attikusdissektor, Austin               | 662               |
| Adson, Elevatorium                         | 498               | Auffangsieb, Weissbarth                | 612               |
| Adson, Nadelhalter                         | 410               | Aufricht, Glabellaraspel               | 712               |
| Adson, Präparierklemme                     | 177               | Aufricht, Nasenhaken                   | 715, 717          |
| Adson, Sauger                              | 364               | Aufsatz, Schumacher                    | 632               |
| Adson, Wundspreizer                        | 285, 294-295, 298 | Austin, Attikusdissektor               | 662               |
| Adson-Baby, Präparierklemme                | 186               | Auswaschbürste                         | 767               |
| Adson-Brown, Chirurgische Pinzette         | 132, 142          | Auward, Gewicht zum Vaginalsepekulum   | 611               |
| Alan-Parks, Analspreizer                   | 580               | Auward, Vaginalsepekulum               | 611               |
| Alan-Parks, Flügelmutter                   | 580               | <b>B</b>                               |                   |
| Alan-Parks, marTract                       | 338               | Babcock, Darm- und Gewebefasszange     | 558-559           |
| Alan-Parks, Mittelvalve                    | 580               | Baby-Adson, Präparierklemme            | 170               |
| Alan-Parks, Seitenvalve                    | 580               | Baby-Poole, Sauger                     | 373               |
| Alderdyce, Doppeldissektor                 | 501               | Baby-Yankauer, Sauger                  | 371               |
| Alexander, Doppelraspatorium               | 496               | Bachhaus, Tuchklemme                   | 211               |
| Alexander, Flachmeißel                     | 459               | Bakelitfuss                            | 669               |
| Alexander, Hohlmeißel                      | 459               | Bakes, Gallenkanaldilatator            | 585               |
| Alexander, Probeexzisionszange             | 631               | Balfour, Bauchdeckenhalter             | 312-313           |
| Allen, Kinderdarmklemme                    | 564               | Balfour, Mittelvalve                   | 313               |
| Allis, Darm- und Gewebefasszange           | 556-557           | Balfour, Mod. USA, Bauchdeckenhalter   | 315               |
| Allis-Adair, Darm- und Gewebefasszange     | 557               | Balfour, Mod. USA, Drahtvalven         | 315               |
| Allis-Baby, Darm- und Gewebefasszange      | 556               | Balfour-Baby, Bauchdeckenhalter        | 311               |
| Alm, Wundspreizer                          | 281               | Balfour-Standard, Bauchdeckenhalter    | 314               |
| Amniotom, Beacham                          | 619               | Balfour-Standard, Mittelvalve          | 312, 314-315      |
| Amputationretraktor, Percy                 | 521               | Ballenger, Schwingmesser               | 700               |
| Amputationsmesser, Liston                  | 13                | Ballenger, Septum-Hohlmeißel           | 705               |
| Analspreizer, Alan-Parks                   | 580               | Ballenger-Hajek, Septumlevatorium      | 703               |
| Anatomische Pinzette                       | 126-127, 148      | Barbara, Mikro-Ohrhäkchen              | 660               |
| Anatomische Pinzette, Adson                | 128, 132          | Barbara, Mikro-Ohrnadel                | 660-661           |
| Anatomische Pinzette, Bonney               | 127               | Baron-Schuknecht, Sauger               | 369               |
| Anatomische Pinzette, Cushing              | 130, 133          | Barraquer, Cilienpinzette              | 155               |
| Anatomische Pinzette, Cushing-Taylor       | 133               | Barraquer, Mikro-Nadelhalter           | 406-407, 419      |
| Anatomische Pinzette, Gerald               | 130               | Barraquer-Troutman, Mikro-Nadelhalter  | 406               |
| Anatomische Pinzette, Jaboma               | 135               | Batteriehandgriff                      | 393               |
| Anatomische Pinzette, Kübler               | 134               | Bauchdeckenhalter, Balfour             | 312-313           |
| Anatomische Pinzette, McIndoe              | 128, 131          | Bauchdeckenhalter, Balfour, Mod. USA   | 315               |
| Anatomische Pinzette, Mikro-Adson          | 143               | Bauchdeckenhalter, Balfour-Baby        | 311               |
| Anatomische Pinzette, Mikro-Adson, Shigeno | 143               | Bauchdeckenhalter, Balfour-Standard    | 314               |
| Anatomische Pinzette, Mini-Adson           | 128               | Bauchdeckenhalter, Collin              | 304-306           |
| Anatomische Pinzette, Potts-Smith          | 130, 133          | Bauchdeckenhalter, Collin, Baby        | 304, 307, 308     |
| Anatomische Pinzette, Schweden-Modell      | 128               | Bauchdeckenhalter, Gosset              | 310-311           |
| Anatomische Pinzette, Semken               | 129               | Bauchdeckenhalter, Gosset-Baby         | 310               |
| Anatomische Pinzette, Taylor               | 129               | Bauchdeckenhalter, Kirschnern          | 317-318           |
| Anatomische Pinzette, Wangenstein          | 134               | Bauchdeckenhalter, O'Sullivan-O'Connor | 316               |
| Anatomische Pinzette, Waugh                | 128               | Bauchdeckenhalter, Ricard              | 307               |
| Anatomisches Skalpell                      | 2                 | Bauchspatel                            | 348               |
| Anderson-Adson, Wundspreizer               | 282               | Bauchspatel, Haberer                   | 348               |
| Antrumkürette, Coakley                     | 719               | Bauchspatel, Kader                     | 275               |
| Antrumstanze                               | 692               | Bauchspatel, Kummel                    | 275               |
| Antrumstanze, Kerrison                     | 698               | Bauchspatel, Martin                    | 348               |
| Anuskop, Ives-Fansler                      | 579               | Beacham, Amniotom                      | 619               |
| Aortahaken, Borowski                       | 266               | Beckenhaken, St. Marks                 | 274               |
| Aortahaken, Ross                           | 265               | Beckenzirkel, Martin                   | 638               |
| Approximator                               | 160               | Beckman-Adson, Wundspreizer            | 299-300           |
| Approximator, Biemer-Müller                | 159               | Beckmann, Ringmesser                   | 720               |
| Arterienklemme, Bengolea                   | 180               | Beckmann, Wundspreizer                 | 298               |
| Arterienklemme, Chaput                     | 168               | Beebee, Drahtschere                    | 110               |
| Arterienklemme, Crile                      | 175               | Beer, Cilienpinzette                   | 155               |
| Arterienklemme, Crile-Rankin               | 176               | Bellucci, Mikro-Ohrscherchen           | 654               |
| Arterienklemme, Dandy                      | 176               | Bengolea, Arterienklemme               | 180               |
| Arterienklemme, Dandy-Mosquito             | 176               | Bennett, Knochenheber                  | 506               |
| Arterienklemme, Dunhill                    | 174               | Benson, Pyloruspreizer                 | 567               |
| Arterienklemme, Halsted-Mosquito           | 171-172           | Bereitstellungsbecher                  | 753               |
| Arterienklemme, Hartmann                   | 171               | Bergmann, Gipschere                    | 443               |
| Arterienklemme, Kelly                      | 174               | Bergmann, Schwammzange                 | 222               |
| Arterienklemme, Kelly-Rankin               | 175               | Bernhard, Tuchklemme                   | 212               |
| Arterienklemme, Kocher                     | 179               | Beschneidungsinstrument, Mogen         | 596               |
| Arterienklemme, Kocher (Ochsner)           | 183-184           | Beyer, Hohlmeißelzange                 | 525               |
| Arterienklemme, Kocher-Nippon              | 179               | Beyer, Ohr-Knochenstanze               | 675               |
| Arterienklemme, Leriche                    | 173               | Biemer, Gefäßclip                      | 158               |
| Arterienklemme, Lovelace                   | 176               | Biemer, Mikroschere                    | 105               |
| Arterienklemme, Mikro-Mosquito             | 173               | Biemer-Müller, Approximator            | 159               |
| Arterienklemme, Negus                      | 203               | Billeau, Ohrschlinge                   | 677               |
| Arterienklemme, Pean                       | 167, 178          | Biopsiefasszange                       | 582               |
| Arterienklemme, Pean (Rochester)           | 181-182           | Biopsiekürette, Kevorkian              | 627               |
| Arterienklemme, Pean-Nippon                | 178               | Biopsiekürette, Mod. München           | 627               |
| Arterienklemme, Pennington                 | 169               | Bircher-Ganske, Knorpelzange           | 511               |
| Arterienklemme, Providence-Hospital        | 173               | Blake, Gallensteinzange                | 586               |
|  |                   | Blake, Uteruskürette                   | 633               |
|  |                   | Blasenhalssperrerr, Millin             | 592               |
|  |                   | Blasenwundsperrerr, Judd-Masson        | 592               |
|  |                   | Blasenwundsperrerr, Millin             | 593               |
|  |                   | Blattvalve, Scoville                   | 321               |
|  |                   | Blohmke, Tonsillenzange                | 729               |
|  |                   | Blount, Kniehaken                      | 507               |
|  |                   | Blount, Knochenheber                   | 507               |
|  |                   | Blumenthal, Hohlmeißelzange            | 524               |
|  |                   | Böhler, Hohlmeißelzange                | 525               |
|  |                   | Böhler, Knochenplitterzange            | 531               |
|  |                   | Bonney, Anatomische Pinzette           | 127               |
|  |                   | Bonney, Chirurgische Pinzette          | 131, 146          |
|  |                   | Borowski, Aortahaken                   | 266               |
|  |                   | Bowman, Sonden                         | 645               |
|  |                   | Boys-Allis, Darm- und Gewebefasszange  | 557               |
|  |                   | Bozemann, Nadelhalter                  | 425               |
|  |                   | Bozemann, Schwammzange                 | 221               |
|  |                   | Brand, Sehnendurchzugzange             | 509               |
|  |                   | Braun, Hakenzange                      | 619, 622          |
|  |                   | Braun, Uterusdepressor                 | 618               |
|  |                   | Braun-Stadler, Episiotomieschere       | 89                |
|  |                   | Breisky, marTract                      | 340               |
|  |                   | Breisky, Vaginalsepekulum              | 612               |
|  |                   | Brom, Venenhäkchen                     | 234               |
|  |                   | Brompton, Rollenklemme                 | 215               |
|  |                   | Brown, Nadelhalter                     | 410               |
|  |                   | Bruchsonde, Mod. Martin                | 436               |
|  |                   | Brünings, Kehlkopfröhr                 | 732               |
|  |                   | Brünings, Schlinge                     | 730               |
|  |                   | Brünings, Septumzange                  | 687               |
|  |                   | Brünings, Tonsillennmesser             | 727               |
|  |                   | Brünings, Tonsillenschnürer            | 730               |
|  |                   | Brünings, Verlängerungsrohr            | 632               |
|  |                   | Brünings, Zangenaufsatz                | 732-733           |
|  |                   | Brunner, Führungshohlschleife          | 435               |
|  |                   | Brunner, Rektum-Anastomosenklemmen     | 575               |
|  |                   | Brunner, Unterbindungsnadel            | 435               |
|  |                   | Brunner, Wundhaken                     | 262-263           |
|  |                   | Bruns, Gipsschere                      | 444, 446          |
|  |                   | Bruns, Scharfer Löffel                 | 483-484           |
|  |                   | Bryant, Korn- u. Tupferzange           | 219               |
|  |                   | Buck, Fadenschere                      | 108               |
|  |                   | Buck, Fremdkörperzangchen              | 672               |
|  |                   | Buck, Ohrkürette                       | 676               |
|  |                   | Bulldogklemme                          | 162               |
|  |                   | Bulldogklemme, DeBakey-Diethrich       | 164               |
|  |                   | Bulldogklemme, Dieffenbach             | 162               |
|  |                   | Bulldogklemme, Diethrich               | 164               |
|  |                   | Bulldogklemme, Johns-Hopkins           | 163               |
|  |                   | Bulldogklemme, Mini-Glover             | 165-166           |
|  |                   | Bunnell, Sehnendurchzugschere          | 508               |
|  |                   | Bürettenbürste                         | 767               |
|  |                   | Bürstenspendler, Martin                | 742-743           |
|  |                   | Busch, Nabelschnurschere               | 90                |
|  |                   | Byrd, Saugrohr                         | 378               |
|  |                   | <b>C</b>                               |                   |
|  |                   | Caplan, Septumschere                   | 694               |
|  |                   | Carroll, Sehnenfasszange               | 509               |
|  |                   | Caspar, Metallstößel                   | 474               |
|  |                   | Castroviejo, Klingenhalter             | 4                 |
|  |                   | Castroviejo, Meßzirkel                 | 644               |
|  |                   | Castroviejo, Mikro-Nadelhalter         | 408, 418-419      |
|  |                   | Castroviejo-Epker, Meßzirkel           | 644               |
|  |                   | Castroviejo-Fino, Mikro-Nadelhalter    | 407               |
|  |                   | Cerullo, Saugventil                    | 370               |
|  |                   | Chaput, Arterienklemme                 | 168               |
|  |                   | Cheattle, Sterilisierzange             | 750               |
|  |                   | Cheron, Tupferzange                    | 221               |
|  |                   | Childe, Wunderpinzette                 | 439               |
|  |                   | Chirurgische Nadel                     | 402               |
|  |                   | Chirurgische Nadeln                    | 403               |
|  |                   | Chirurgische Pinzette                  | 137-139, 143, 148 |
|  |                   | Chirurgische Pinzette, Adlerkreuz      | 139               |
|  |                   | Chirurgische Pinzette, Adson           | 132, 140          |
|  |                   | Chirurgische Pinzette, Adson-Brown     | 132, 142          |
|  |                   | Chirurgische Pinzette, Bonney          | 131, 146          |
|  |                   | Chirurgische Pinzette, Cushing         | 142               |
|  |                   | Chirurgische Pinzette, Durante         | 145               |
|  |                   | Chirurgische Pinzette, Gerald          | 131, 142          |
|  |                   | Chirurgische Pinzette, Gillies         | 131, 140          |
|  |                   | Chirurgische Pinzette, Jaboma          | 135               |
|  |                   | Chirurgische Pinzette, Mayo            | 146               |
|  |                   | Chirurgische Pinzette, Mikro-Adson     | 143               |
|  |                   | Chirurgische Pinzette, Mini-Adson      | 143               |
|  |                   | Chirurgische Pinzette, Nelson          | 147               |
|  |                   | Chirurgische Pinzette, Oehler          | 134               |
|  |                   | Chirurgische Pinzette, Potts-Smith     | 142               |

Chirurgische Pinzette, Resano .....147  
 Chirurgische Pinzette, Russ. Modell .....145  
 Chirurgische Pinzette, Semken .....131, 140  
 Chirurgische Pinzette, Stille .....139  
 Chirurgische Pinzette, Stille-Barraya .....145  
 Chirurgische Pinzette, Taylor .....141  
 Chirurgische Pinzette, Waugh .....140  
 Chirurgische Schere .....16-23, 92  
 Chirurgische Schere, Deaver .....23  
 Chirurgische Schere, Goldman-Fox .....91  
 Chirurgische Schere, Joseph .....60-61  
 Chirurgische Schere, Kelly .....32-33  
 Chirurgische Schere, Knapp .....22  
 Chirurgische Schere, Mayo .....24-25  
 Chirurgische Schere, Sanvenero .....59  
 Chirurgische Schere, Wagner .....92  
 Cilienpinzette .....155  
 Cilienpinzette, Barraquer .....155  
 Cilienpinzette, Beer .....155  
 Cilienpinzette, Douglas .....155  
 Cilienpinzette, Littauer .....155  
 Cinelli, Nasenschere .....50  
 Cinelli, Osteotom .....708  
 Circumcisionsgerät .....596  
 Citelli, Ohr-Knochenstanze .....674  
 Cleveland, Hohlmeißelzange .....522  
 Cleveland, Knochensplitterzange .....531  
 Clip-Anlegepinzette .....158  
 Clip-Anlegezange .....161  
 Clip-Anlegezange, Mini-Glover .....166  
 Cloward, Valve .....296-297  
 Cloward, Wundspreizer .....296-297  
 Coakley, Antrumkürette .....719  
 Cobb, Hohlmeißel .....470  
 Cobb, Raspatorium .....492  
 Cogswell, Sauger .....378  
 Collier, Nadelhalter .....409  
 Collin, Baby, Bauchdeckenhalter .....304, 307-308  
 Collin, Bauchdeckenhalter .....304-306  
 Collin, Hammer .....476  
 Collin, Mittelvalve .....305-306  
 Collin, Nabelschnurklemme .....642  
 Collin, Organfasszange .....169  
 Collin, Skalpellgriff .....6  
 Collin, Tumorfasszange .....169  
 Collin, Tupferzange .....221  
 Collin, Uterusfasszange .....625  
 Collin, Vaginalsekulum .....600  
 Collin-Hartmann, Wundhaken .....276  
 Columellapinzette, Cottle .....719  
 Converse, Nasenflügelhäkchen .....716  
 Converse, Nasenhaken .....716  
 Converse, Nasenschere .....88  
 Converse, Rhinoplastikmesser .....699  
 Cooley, Atriumhaken .....271  
 Cooley, Sauger .....375  
 Cooper, Unterbindungsnadel .....432  
 Cordes, Zangenaufsatz .....733  
 Coronarschere, Dietrich-Potts .....73  
 Coryllos, Wundhaken .....260  
 Cottle, Columellapinzette .....719  
 Cottle, Hammer .....476  
 Cottle, Hautfasspinzette .....719  
 Cottle, Knorpelquetsche .....710  
 Cottle, Nasenflügelhäkchen .....717  
 Cottle, Nasenhaken .....715  
 Cottle, Nasenhaken .....717  
 Cottle, Nasenraspel .....711  
 Cottle, Nasenschere .....85  
 Cottle, Nasenspekulum .....682-683  
 Cottle, Osteotom .....706  
 Cottle, Periostelevatorium .....704  
 Cottle, Raspatorium .....490  
 Cottle, Rhinoplastikmesser .....699  
 Cottle, Sattelhäkchen .....717  
 Cottle, Septumlevatorium .....703-704  
 Cottle-Kazanjan, Knochensplitterzange .....530  
 Cottle-Neivert, Nasenflügelhäkchen .....717  
 Cottle-Walsham, Septumrichtzange .....718  
 Coupland, Saugeraufsatz .....378  
 Coupland, Saugerhandgriff .....378  
 Crafoord, Präparierklemme .....188  
 Crile, Arterienklemme .....175  
 Crile, Nadelhalter .....414  
 Crile-Murray, Nadelhalter .....410  
 Crile-Rankin, Arterienklemme .....176  
 Crile-Wood, Nadelhalter .....410, 415, 420  
 Cosco, Vaginalsekulum .....600  
 Cushing, Anatomische Pinzette .....130, 133, 142

Cushing, Sattelhäkchen .....232  
 Cushing, Wundhäkchen .....231  
 Cushing-Taylor, Anatomische Pinzette .....133  
 Cuzzi, Abortuslöffel .....641  
 Czerny, Hakenzange .....622  
 Czerny, Mastdarm-Rektum-Spekulum .....579

**D**  
 Dämpfer, Rydel-Seiffert .....669  
 Dandy, Arterienklemme .....176  
 Dandy-Mosquito, Arterienklemme .....176  
 Darm- und Gewebefasszange, Allis .....556-557  
 Darm- und Gewebefasszange, Allis-Adair .....557  
 Darm- und Gewebefasszange, Allis-Baby .....556  
 Darm- und Gewebefasszange, Babcock .....558-559  
 Darm- und Gewebefasszange, Boys-Allis .....557  
 Darm- und Gewebefasszange, Duval .....559-560  
 Darm- und Gewebefasszange, Judd-Allis .....557  
 Darm- und Gewebefasszange, Lockwood .....557  
 Darm- und Gewebefasszange, Thoms-Allis .....557  
 Darm- und Gewebefasszange, Williams .....558  
 Darm-Anastomosenklemme, De Martel-Wolfson .....566  
 Darmklemme, Doyen .....560  
 Darmklemme, Doyen-Baby .....561, 571  
 Darmklemme, Kocher .....563-564, 573-574  
 Darmklemme, Mayo-Robson .....562, 572  
 Darmklemme, Scudder .....575  
 Darmquetschklemme, Payr .....565  
 Darmquetschklemme, Payr-Baby .....565  
 Darmschere .....106  
 Dartigues, Uterusfasszange .....625  
 Daubenspeck, Scharfer Löffel .....482  
 Davidson, Scapulahaken .....261  
 Day, Ohrhäkchen .....678  
 DeBakey, Gefäßschere .....72  
 DeBakey, Winkelschere .....122  
 DeBakey-Adson, Sauger .....371  
 De Martel-Wolfson, Darm-Anastomosenklemme .....566  
 De Martel-Wolfson, Klemmenhalterung .....567  
 De Martel-Wolfson, Klemmenschießzange .....566  
 Dean, Tonsillenschere .....80, 82  
 Deaver, Chirurgische Schere .....23  
 Deaver, marTract .....337  
 Deaver, Wundhaken .....268-270  
 DeBakey, Atraumatische Pinzette .....135-136  
 DeBakey, Nadelhalter .....422  
 DeBakey, Präparierschere .....49  
 DeBakey-Dietrich, Bulldogklemme .....164  
 Derf, Nadelhalter .....409, 419  
 Dermatol, Humby .....14  
 Dermatol, Schink .....14  
 Deschamps, Unterbindungsnadel .....433-434  
 Desjardins, Gallenkanalklemme .....201  
 Desjardins, Gallensteinzange .....587  
 Desmarres, Sattelhäkchen .....229  
 Dieffenbach, Bulldogklemme .....162  
 Diethrich, Bulldogklemme .....164  
 Diethrich, Gefäßschere .....72  
 Diethrich-Salyer, Präparierschere .....72  
 Diethrich-Hegemann, Gefäßschere .....74  
 Dietrich-Potts, Coronarschere .....73  
 Dietrich-Potts, Gefäßschere .....73  
 Dilatationssonde, Ritter-Halle .....720  
 Dingmann, Knorpelfasszange .....511  
 Dittel, Kathetereinführinstrument .....388  
 Doppeldissektor .....501  
 Doppeldissektor, Alderdyce .....501  
 Doppeldissektor, McDonald .....501  
 Doppeldissektor, Faulkner .....719  
 Doppeldissektor, Molt .....487  
 Doppelraspatorium, Alexander .....496  
 Dose .....760  
 Douglas, Cilienpinzette .....155  
 Doyen, Darmklemme .....560  
 Doyen, Gynäkologische Schere .....34  
 Doyen, Hammer .....475  
 Doyen, Hohlsonde .....351  
 Doyen, Myomheber .....624  
 Doyen, Rippenraspatorium .....495  
 Doyen, Scheidenhalter .....612  
 Doyen, Vaginalsekulum .....608  
 Doyen, Wundhaken .....258  
 Doyen-Baby, Darmklemme .....561, 571  
 Doyen-Stille, Wundhaken .....254  
 Drahtbiegezangchen, McGee .....656  
 Drahtschere, Beebe .....110  
 Drahtschere, Martin .....124  
 Drahtschere, Universal .....109  
 Drahtvalven, Balfour, Mod. USA .....315

Dreiwegehahn .....385  
 Dunhill, Arterienklemme .....174  
 Duplay, Hakenzange .....619  
 Durante, Chirurgische Pinzette .....145  
 Durchflusshahn .....385  
 Duval, Darm- und Gewebefasszange .....559-560

**E**  
 Echlin, Hohlmeißelzange .....527  
 Eicken-Killian, Spülkanüle .....720  
 Einführungsängchen, Fuller .....658  
 Einmalskalpell .....11-12  
 Eiselsberg, Fadenschere .....108  
 Elevatorium, Adson .....498  
 Elevatorium, Langenbeck .....500  
 Elevatorium, Martin-Langenbeck .....500  
 Elevatorium, Quervain .....501  
 Elevatorium, Sebileau .....501  
 Elevatorium, Williger .....501  
 Emmett, Fistelhaken .....626  
 Endospekulum, Kogan .....613  
 Enukleationsschere .....103  
 Episiotomieschere, Braun-Stadler .....89  
 Episiotomieschere, Waldmann .....89  
 Ersatzbacke .....478-479  
 Ersatzbacken, Mead .....477  
 Ersatzglas .....743  
 Ersatzklinge, Humby .....14  
 Ersatzklinge, Schink .....14  
 Ersatzklinge, Silver .....14  
 Ersatzknopf, Lucae .....668  
 Ersatzlampe .....393  
 Ersatzmesser, Stille-Martin .....445  
 Esmarch, Gipsmesser .....447  
 Esmarch, Gipsschere .....443  
 Eves, Tonsillenschürer .....730

**F**  
 Face-Lift Klemme, Martel-Rees .....170  
 Face-lift Schere .....66  
 Face-lift Schere, Aston .....45  
 Face-lift Schere, Gorney .....45, 119  
 Face-Lift Schere, Gorney-Freeman .....118  
 Face-lift Schere, Kaye .....44  
 Face-lift Schere, Peck-Joseph .....62-63  
 Face-Lift Schere, Rees .....119  
 Face-lift Schere, Salyer .....107  
 Fadenfänger, Modell Wien .....438  
 Fadengabel .....438  
 Fadenklemme .....171  
 Fadenpinzette, Ochsner .....438  
 Fadenschere, Buck .....108  
 Fadenschere, Eiselsberg .....108  
 Fadenschere, Littauer .....108  
 Fadenschere, Northbent .....107  
 Fadenschere, O'Brian .....107  
 Fadenschere, Spencer .....108  
 Farabeuf, Knochenhaltezange .....516  
 Farabeuf, Raspatorium .....491  
 Farabeuf, Wundhaken .....277  
 Farabeuf-Collin, Raspatorium .....491  
 Farrell, Watterträger .....355  
 Farrior, Ohrspekulum .....665  
 Fasspinzette, Singley-Tuttle .....146  
 Faulkner, Doppelkürette .....719  
 Faure, Peritoneumklemme .....210  
 Faure, Probexzisionszange .....628  
 Favalaro, Gefäßschere .....77  
 Feder, Low-Profile .....302  
 Fehland, Rektum-Anastomosenklemme .....577  
 Feilchenfeld, Splitterpinzette .....154  
 Feine Präparierschere, Lexer-Fino .....52  
 Feine Präparierschere, Metzenbaum-Fino .....53-58, 113, 117  
 Feine Präparierschere, Metzenbaum-Lahey .....117  
 Feine Präparierschere, Siegert .....117  
 Feine Präparierschere, Toennis-Adson .....78, 113  
 Fergusson, Knochenhaltezange .....513  
 Fergusson, Sauger .....365-366  
 Ferris-Smith-Kerrison, Keilbeinstanze .....697  
 Finocchio, Nadelhalter .....412, 423  
 Finocchio, Präparierklemme .....198  
 Finsen, Wundspreizer .....280  
 Finsen-Martin, Wundspreizer .....280  
 Fisch, Mikro-Dissektor .....662  
 Fisher, Tonsillenschere .....727  
 Fistelhaken, Emmett .....626  
 Fistelhaken, Simon .....626  
 Flachmeißel .....457

- Flachmeißel, Alexander .....459  
 Flachmeißel, Hibbs .....471  
 Flachmeißel, Partsch .....458  
 Flachmeißel, Stille .....460  
 Flügelmutter, Alan-Parks .....580  
 Fomon, Meißel .....707  
 Fomon, Nasenflügelhäkchen .....715-716  
 Fomon, Nasenraspel .....712, 714  
 Fomon, Nasenschere .....50, 83-84  
 Fomon, Rhinoplastikmesser .....699  
 Foregger, Kaltlicht-Laryngoskopiebesteck .....396  
 Foregger, Kaltlicht-Laryngoskopspatel .....397  
 Foregger, Laryngoskopiebesteck .....391-392  
 Foregger, Laryngoskopspatel .....392-393  
 Förster, Schwammzange .....222-223  
 Foster-Gillies, Nadelhalter .....428  
 Fraenkel, Zangenaufsatz .....732  
 Frazier, Sauger .....364  
 Freer, Mukosahäkchen .....716  
 Freer, Mukosamesser .....700  
 Freer, Septumelektorium .....701-702  
 Freer, Septum-Hohlmeißel .....705  
 Freer, Septummeißel .....705  
 Freer, Septummesser .....700  
 Fremdkörperheber, Zaufal .....677  
 Fremdkörperzangchen, Buck .....672  
 Fremdkörperzange, Mathieu .....597  
 French, Stimmgabel .....666  
 Friedmann, Hohlmeißelzange .....522  
 Fritsch, Wundhaken .....257  
 Frosch, Knochenhalte zange .....513  
 Frykholm, Hohlmeißelzange .....528  
 Führungshohlsonde, Brunner .....435  
 Führungshohlsonde, König .....437  
 Führungshohlsonde, Payr .....438  
 Führungshohlsonde, Schmieden .....436  
 Führungshohlsonde, Schmieden-Payr .....436  
 Fuller, Einführungs zängchen .....658  
 Fuss, Lucae .....668  
 Fusshalter, Hartmann .....668
- G**  
 Gallenkanaldilatator, Bakes .....585  
 Gallenkanalklemme, Desjardins .....201  
 Gallenkanalklemme, Lahey .....198  
 Gallensteinlöffel, Luer-Körte .....588  
 Gallensteinzange, Blake .....586  
 Gallensteinzange, Desjardins .....587  
 Gallensteinzange, Mayo-Blake .....586  
 Gallensteinzange, Mixer .....587  
 Gaumenraspatorium .....726  
 Gaumenraspatorium, Krenkel .....701  
 Gaumenspaltdissektor, Salyer .....726  
 Gaumenspaltelevatorium, Salyer .....726  
 Gaumenspaltenhaken, Salyer .....726  
 Geburtslöffel, Sellheim .....640  
 Geburtszange, Kielland .....639  
 Geburtszange, Nägele .....638  
 Geburtszange, Piper .....639  
 Geburtszange, Simpson .....638  
 Geburtszange, Wrigley .....638  
 Gefäßclip, Biemer .....158  
 Gefäß-Dilatationspinzette, Jeweler mod. ....150  
 Gefäßschere .....71, 77  
 Gefäßschere, De Bakey .....72  
 Gefäßschere, Diethrich .....72  
 Gefäßschere, Diethrich-Hegemann .....74  
 Gefäßschere, Diethrich-Potts .....73  
 Gefäßschere, Favaloro .....77  
 Gefäßschere, Potts-Smith .....74-75  
 Gefäßschere, Satinsky .....71  
 Gefäßschere, Schmieden-Taylor .....77  
 Gefäß-Spülkanüle, Schmid .....384  
 Gellhorn, Probeexzisionszange .....628  
 Gelpi, Wundspreizer .....303  
 Gemini, Präparierklemme .....192  
 Gerald, Anatomische Pinzette .....130  
 Gerald, Atraumatische Pinzette .....136  
 Gerald, Chirurgische Pinzette .....131, 142  
 Gewicht zum Vaginalsepekulum, Auvard .....611  
 Gewicht zum Vaginalsepekulum, Scherbak .....610  
 Gewichte, Rydel-Seiffert .....669  
 Gillies, Chirurgische Pinzette .....131, 140  
 Gillies, Nadelhalter .....414, 428  
 Gillies-Mini, Nadelhalter .....428  
 Gil-Vernet, Sattelhäkchen .....233  
 Gipsabreisszange, Wolff .....449  
 Gipsmesser, Esmarch .....447  
 Gipsmesser, Hopkins .....447  
 Gipsmesser, Martin .....447  
 Gipsschere, Bergmann .....443  
 Gipsschere, Bruns .....444, 446  
 Gipsschere, Esmarch .....443  
 Gipsschere, Stille-Martin .....445  
 Gipsspreizer, Hennig .....448  
 Gipsspreizer, Quattro .....448  
 Glabellaraspel, Aufricht .....712  
 Glas-Reinigungsbürste .....767  
 Goelet, Wundhaken .....279  
 Goldman-Fox, Chirurgische Schere .....91  
 Goldman-Fox, Zahnfleischschere .....91  
 Goldsmith (Thudichum), Nasensepekulum .....680  
 Good, Tonsillenschere .....81  
 Gorney, Face-lift Schere .....45, 119  
 Gorney-Freeman, Face-Lift Schere .....118  
 Gosset, Bauchdeckenhalter .....310-311  
 Gosset, Mittelvalve .....310  
 Gosset-Baby, Bauchdeckenhalter .....310  
 Graefe, Mikrohäkchen .....226  
 Graig, Septumzangen .....687  
 Grave, Vaginalsepekulum .....601  
 Green-Armytage, Klemmzange .....640  
 Greene, Uteruskürette .....636  
 Griff für Kehlkopfspiegel .....735  
 Griff zum Vaginalsepekulum, Scherbak .....609-610  
 Gross, Ohrlöffel und Häkchen .....677  
 Gross-Maier, Korn- u. Tupferzange .....220  
 Grünwald (Jansen), Nasentamponpinzette .....686  
 Grünwald, Ohrpinzette .....671  
 Guedel-Negus, Laryngoskopiebesteck .....390  
 Guedel-Negus, Laryngoskopspatel .....390  
 Guilen, Obturator .....720  
 Guilen, Saugraspatorium .....720  
 Gunnar-Hey, Rollenklemme .....215  
 Guthrie, Hauthäkchen .....227  
 Guttman, Vaginalsepekulum .....601  
 Guyon, Harnröhrenbougie .....594  
 Guyon, Nierenstielklemme .....199-200  
 Gynäkologische Schere .....120-121  
 Gynäkologische Schere, Doyen .....34  
 Gynäkologische Schere, Sims .....30-31  
 Gynäkologische Schere, Sims-Siebold .....35  
 Gynäkologische Schere, Wertheim .....36
- H**  
 Haberer, Bauchspatel .....348  
 Haemorrhoiden-Fasszange, McGinvey .....582  
 Hajek, Keilbeinstanze .....696  
 Hakenhalterung, Martin-Rochard .....323  
 Hakensystem, Martin-Rochard .....323  
 Hakenvalve, Scoville .....321  
 Hakenzange .....622  
 Hakenzange, Braun .....619, 622  
 Hakenzange, Czerny .....622  
 Hakenzange, Duplay .....619  
 Hakenzange, Iowa .....621  
 Hakenzange, Jacobs .....621  
 Hakenzange, Museux .....621  
 Hakenzange, Schröder .....619-620  
 Hakenzange, Skene .....620  
 Hakenzange, Teale .....620  
 Halle, Scharfer Löffel .....485  
 Halle, Septumelektorium .....701  
 Halsey, Nadelhalter .....409, 420  
 Halsted-Mosquito, Arterienklemme .....171, 172  
 Haltearm, Martin-Rochard .....323  
 Halteschraube .....462  
 Hammer, Collin .....477-480  
 Hammer, Collin .....476  
 Hammer, Cottle .....476  
 Hammer, Doyen .....475  
 Hammer, Lucae .....476  
 Hammer, Mead .....477  
 Hammer, Partsch .....478  
 Hammer, Williger .....475, 477  
 Hammerkopfzängchen, House-Dieter .....657  
 Handdermatom, Silver .....14  
 Handgriff .....354, 369  
 Handgriff, Yankauer .....372  
 Handwaschbürste, Martin-Aseptic .....742  
 Hank, Uterusdilatator .....617  
 Harnröhrenbougie, Guyon .....594  
 Harnröhrenbougie, Van Buren .....594  
 Harrington, marTract .....339  
 Harrington, Wundhaken .....267  
 Hartmann, Arterienklemme .....171  
 Hartmann, Fusshalter .....668  
 Hartmann, Hohlmeißelzange .....523  
 Hartmann, Nasenpolypenzange .....686  
 Hartmann, Ohrhäkchen .....677  
 Hartmann, Ohrkatheter .....670  
 Hartmann, Ohrpolypenzange .....672-673  
 Hartmann, Ohrspekula, Satz .....664  
 Hartmann, Ohrspekulum .....664  
 Hartmann, Scharfe Nasenzange .....693  
 Hartmann, Stimmgabel .....666-668  
 Hartmann, Tonsillenzange .....731  
 Hartmann-Halle, Nasensepekulum .....680  
 Hartmann-Herzfeld, Ohrpolypenzange .....673  
 Hartmann-Hoffmann, Ohrpolypenzange .....673  
 Hartmann-Wullstein, Ohrpolypenzange .....673  
 Hautfasspinzette, Cottle .....719  
 Hautfasspinzette, Ogura .....719  
 Hauthäkchen .....226  
 Hauthäkchen, Guthrie .....227  
 Hauthäkchen, O'Connor .....227  
 Hayes, Rektum-Anastomosenklemme .....576  
 Heaney, Hysterektomie klemme .....204  
 Heaney, Nadelhalter .....411, 422  
 Heavy Duty, Mikro-Nadelhalter .....416  
 Hegar, Nadelhalter .....425  
 Hegar, Uterusdilatator .....614-616  
 Hegar-Baumgartner, Nadelhalter .....410, 420  
 Hegar-Vascular, Nadelhalter .....425  
 Hegebarth, Wundklammerpinzette .....439  
 Heiming, Nierensteinzange .....584  
 Heiss, Präparierklemme .....186  
 Henke, Tonsillenelevatorium .....728  
 Henley, Mittelvalve .....293  
 Henley, Wundspreizer .....293  
 Hennig, Gipspreizer .....448  
 Heparinnadel .....381  
 Hepp-Scheidel, Mikro-Nadelhalter .....415  
 Hepp-Scheidel, Tubenfasspinzette .....147  
 Heprainnadel, Mock .....381, 384  
 Heymann, Nasenschere .....86-87  
 Heywood-Smith, Uteruspolypenzange .....623  
 Hibbs, Flachmeißel .....471  
 Hibbs, Hohlmeißel .....472  
 Hibbs, Osteotom .....471-472  
 Hohenfellner, Präparierschere .....49  
 Hohlmeißel .....457  
 Hohlmeißel, Alexander .....459  
 Hohlmeißel, Cobb .....470  
 Hohlmeißel, Hibbs .....472  
 Hohlmeißel, Lexer .....465  
 Hohlmeißel, Lexer-Mini .....464  
 Hohlmeißel, Partsch .....458  
 Hohlmeißel, Stille .....461  
 Hohlmeißel, Walter .....707  
 Hohlmeißel, Zielke .....459  
 Hohlmeißelzange .....524  
 Hohlmeißelzange, Beyer .....525  
 Hohlmeißelzange, Blumenthal .....524  
 Hohlmeißelzange, Böhler .....525  
 Hohlmeißelzange, Cleveland .....522  
 Hohlmeißelzange, Echlin .....527  
 Hohlmeißelzange, Friedmann .....522  
 Hohlmeißelzange, Frykholm .....528  
 Hohlmeißelzange, Hartmann .....523  
 Hohlmeißelzange, Jansen .....523  
 Hohlmeißelzange, Leksell-Stille .....528  
 Hohlmeißelzange, Lempert .....523  
 Hohlmeißelzange, Luer .....525  
 Hohlmeißelzange, Marquard .....526  
 Hohlmeißelzange, Mayfield .....526  
 Hohlmeißelzange, Mead .....523  
 Hohlmeißelzange, Ruskin .....526  
 Hohlmeißelzange, Semb .....526  
 Hohlmeißelzange, Stellbrink .....522  
 Hohlmeißelzange, Stille .....526  
 Hohlmeißelzange, Stille-Luer .....529  
 Hohlmeißelzange, Stille-Ruskin .....527  
 Hohlmeißelzange, Zaufal-Jansen .....525  
 Hohlsonde .....351  
 Hohlsonde, Doyen .....351  
 Hohlsonde, Nelaton .....351  
 Hohmann, Knochenheber .....503-505  
 Hohmann, mini, Knochenheber .....502  
 Hoke, Osteotom .....471  
 Hopkins, Gipsmesser .....447  
 Hösel, Wundhaken .....255  
 House, Mikro-Kürette .....663  
 House, Mikro-Messsonde .....663  
 House, Saugadapter .....374  
 House, Sauger .....374  
 House-Dieter, Hammerkopfzängchen .....657



Howard, Septumeleveatorium .....703  
Huber, Universalsgriff.....632  
Humby, Dermatome .....14  
Humby, Ersatzklinge.....14  
Hunter, Splitterpinzette .....154  
Hurd, Tonsillenelevator/Retraktor.....727  
Hysterektomieklammer, Heaney .....204  
Hysterektomieklammer, Moynihan .....207  
Hysterektomieklammer, Phaneuf.....204  
Hysterektomieklammer, Wertheim.....208  
Hysterektomieklammer, Wertheim-Cullen .....205

**I**  
Infektionsschutzbrille .....746  
Innendose .....752  
Instrumentenkasten .....759  
Instrumententablett .....758  
Inzisionsschere .....23  
Iowa, Hakenzange .....621  
Irisschere .....95-99  
Irisschere, Jabaley.....100  
Irisschere, Mod. Bonn.....96  
Irisschere, Stevens .....101-102  
Israel, Wundhaken.....242  
Isterson, Trachealhaken .....549  
IUP-Fasszange .....632  
Ives-Fansler, Anuskop.....579

**J**  
Jabaley, Irisschere.....100  
Jaboma, Anatomische Pinzette .....135  
Jaboma, Chirurgische Pinzette .....135  
Jaboma, Mikroschere .....105  
Jaboma, Nadelhalter .....415  
Jackson, Trachealhaken .....549  
Jackson, Vaginalspekulum.....602  
Jacobs, Hakenzange .....621  
Jacobson, Scharfer Doppellöffel .....486  
Jameson, Nadelhalter.....412  
Jameson, Präparierschere .....69  
Jamieson, Sauger .....377  
Jansen, Hohlmeißelzange.....523  
Jansen, Ohrlöffel .....677  
Jansen, Ohrpinzette .....671  
Jansen, Wundspreizer .....281  
Jeweler mod., Gefäß-Dilatationspinzette .....150  
Jeweler mod., Mikropinzette .....150  
Johns-Hopkins, Bulldogklemme .....163  
Johnson, Nadelhalter.....413  
Joll, Thyreoid- und Vulva-Spreizer .....303  
Jones, Tuchklemme .....211  
Joseph, Chirurgische Schere .....60-61  
Joseph, Knochenfeile .....711  
Joseph, Mukosahäkchen.....715-716  
Joseph, Nasensäge .....709  
Joseph, Periostelevatorium .....704  
Joseph, Rhinoplastikmesser .....699  
Joseph, Septumeleveatorium .....701  
Joseph-Masing, Periostelevatorium.....704  
Judd-Allis, Darm- und Gewebefasszange .....557  
Judd-Masson, Blasenwundsperrerr .....592

**K**  
Kader, Bauchspatel .....275  
Kahre-Williger, Raspatorium .....494  
Kallmorgen, Scheidenhalter .....607  
Kallmorgen, Vaginalspekulum.....607  
Kaltlicht-Batteriehandgriff.....394, 396, 398, 400  
Kaltlicht-Laryngoskopiebesteck, Foregger.....396  
Kaltlicht-Laryngoskopiebesteck, McIntosh.....394  
Kaltlicht-Laryngoskopiebesteck, Miller .....398  
Kaltlicht-Laryngoskopspatel, Foregger .....397  
Kaltlicht-Laryngoskopspatel, McIntosh .....394-395  
Kaltlicht-Laryngoskopspatel, Miller .....398-399  
Kanülenadel.....381  
Kappenzange, Mod. Martin.....754  
Kapselasszange, Millin .....590-591  
Katheteransatz .....385  
Kathetereinführinstrument, Dittel .....388  
Kathetereinführungszange, Magill.....388  
Kaye, Face-lift Schere .....44  
Kaye, Skalpellgriff.....8  
Kehlkopfrühr, Brünings.....732  
Kehlkopfspiegel.....734  
Kehlkopfspiegel, Michel.....735  
Keilbeinstanze, Ferris-Smith-Kerrison .....697  
Keilbeinstanze, Hajek .....696  
Kelly, Arterienklemme .....174  
Kelly, Chirurgische Schere .....32-33

Kelly, Präparierklemme .....202  
Kelly, Sphinkteroskop .....581  
Kelly, Uteruspolypenzange .....623  
Kelly, Wundhaken .....253, 273  
Kelly-Rankin, Arterienklemme .....175  
Kern, Knochenhalte-zange.....515  
Kerrison, Antrumstanze .....698  
Kevorkian, Biopsiekürette.....627  
Kevorkian, Probeexzisionszange.....631  
Key, Raspatorium .....491  
Kielland, Geburtszange.....639  
Killian, Nasenspekulum .....681  
Killian, Septumeleveatorium .....703  
Killian, Septum-Hohlmeißel .....705  
Killian-Claus, Septum-Hohlmeißel .....705  
Kilner, Nadelhalter.....419  
Kilner, Nasenflügelhäkchen .....716  
Kilner, Präparierschere.....65  
Kinderdarmklemme, Allen .....564  
Kirschner, Bauchdeckenhalter .....317-318  
Kirschner, marTract .....334  
Kirschner, Rahmen .....317-319  
Kirschner, Rahmenhaken .....317-319  
Klapp, Wundhaken .....235  
Kleinert-Kutz, Sehnenfasszange .....510  
Klemmenhalterung, De Martel-Wolfson .....567  
Klemmschließzange, De Martel-Wolfson .....566  
Klemmzange, Green-Armytage .....640  
Klingenbrecher u. -Halter .....4  
Klingenthaler, Castroviejo .....4  
Klingenthaler, Troutman-Chris .....4  
Knapp, Chirurgische Schere .....22  
Knapp, Präparierschere.....114  
Kniehaken, Blount .....507  
Knight, Septumzange .....687  
Knochenfasszange .....514  
Knochenfeile.....497  
Knochenfeile, Joseph .....711  
Knochenfeile, Miller.....499  
Knochenfeile, Miller-Colburn .....498-499  
Knochenhäkchen, Rasse .....226  
Knochenhalte-zange.....511, 518  
Knochenhalte-zange, Farabeuf .....516  
Knochenhalte-zange, Ferguson .....513  
Knochenhalte-zange, Frosch .....513  
Knochenhalte-zange, Kern.....515  
Knochenhalte-zange, Lane .....519  
Knochenhalte-zange, Langenbeck .....513  
Knochenhalte-zange, Lewin .....512  
Knochenhalte-zange, Semb .....515  
Knochenhalte-zange, Ulrich.....517  
Knochenhalte-zange, Verbrugge.....520-521  
Knochenhebel.....502  
Knochenhebel, Bennett.....506  
Knochenhebel, Blount.....507  
Knochenhebel, Hohmann .....503-505  
Knochenhebel, Hohmann, mini .....502  
Knochenhebel, Lange-Hohmann .....505  
Knochenmeißel .....456  
Knochenraspel, Putti .....473  
Knochensplitterzange, Böhler.....531  
Knochensplitterzange, Cleveland .....531  
Knochensplitterzange, Cottle-Kazanjan .....530  
Knochensplitterzange, Liston.....530  
Knochensplitterzange, Liston-Key .....534  
Knochensplitterzange, Ruskin-Liston .....532  
Knochensplitterzange, Stille-Liston.....532-533  
Knorpelrepositions-zange .....512  
Knopfschere .....350  
Knopfschere, Stacked .....350  
Knorpelfasszange, Dingmann .....511  
Knorpelfasszange, Martin .....512  
Knorpelquetsche, Cottle .....710  
Knorpelzange, Bircher-Ganske .....511  
Kocher (Ochsner), Arterienklemme .....183-184  
Kocher, Arterienklemme .....179  
Kocher, Darmklemme .....563-564, 573-574  
Kocher, Kropfsonde .....550  
Kocher, Wundhaken.....239, 247, 251, 258  
Kocher-Langenbeck, Wundhaken .....248-249  
Kocher-Nippun, Arterienklemme .....179  
Kogan, Endoskopium .....613  
König, Führungshohlsonde .....437  
König, Raspatorium .....490  
König, Stimmgabel .....669  
Korn-u. Tupferzange, Bryant .....219  
Korn-u. Tupferzange, Gross-Maier .....220  
Korn-u. Tupferzange, Martin .....219  
Korn-u. Tupferzange, Ulrich .....218

Körte, Wundhaken.....241  
Krause, Polypenschnürer .....670, 684  
Krause, Zangenaufsatz .....733  
Krause-Voss, Polypenschnürer .....670, 684  
Krenkel, Gaumenraspatorium .....701  
Kressner, Septumzange.....718  
Kristeller, Scheidenhalter .....603-606  
Kristeller, Vaginalspekulum .....603-606  
Kronecker, Unterbindungsnadel .....432  
Kropffasszange, Lahey.....550  
Kropfsonde, Kocher.....550  
Kübler, Anatomische Pinzette.....134  
Kübler, Nadelhalter .....430  
Kübler, Präparierschere .....44  
Kümmel, Bauchspatel .....275  
Kunststoffspitze, Nabatoff .....353  
Kupplungsstück .....636  
Kurze Mikro-Schere.....70

**L**  
La Grange, Zahnfleissschere.....93  
Laborde, Trachealdilatator .....548  
Lagerungsetui für Laryngoskope .....393  
Lahey, Gallenkanalklemme.....198  
Lahey, Kropffasszange.....550  
Lahey, Wundhaken .....246  
Lambotte, Osteotom.....467-468  
Lambotte, Raspatorium .....496  
Lambotte-Mini, Osteotom.....466  
Laminektomiesperrerr, Scoville.....320  
Laminektomiesperrerr, Scoville-Haverfield .....320  
Landolt, Raspatorium .....490  
Landolt, Sauger .....370  
Lane, Knochenhalte-zange .....519  
Lane, Magen und Darm-Zwillingsklemmen .....568-569  
Lane, Tuchklemme .....213  
Lange, Nasenflügelhäkchen .....715  
Lange, Zangenaufsatz .....733  
Lange-Hohmann, Knochenhebel .....505  
Langenbeck, Elevatorium .....500  
Langenbeck, Knochenhalte-zange .....513  
Langenbeck, marTract.....335-336, 339  
Langenbeck, Nadelhalter .....430  
Langenbeck, Raspatorium .....490  
Langenbeck, Wundhaken.....243-245  
Langenbeck-Green, Wundhaken.....245  
Langenbeck-Mini, Wundhäkchen.....229  
Lappenmesser, Plester .....659  
Laryngoskopiebesteck, Foregger .....391-392  
Laryngoskopiebesteck, Guedel-Negus .....390  
Laryngoskopiebesteck, McIntosh.....391  
Laryngoskopiebesteck, Miller .....389  
Laryngoskopiebesteck, Miller-Baby .....389  
Laryngoskopspatel, Foregger.....392-393  
Laryngoskopspatel, Guedel-Negus.....390  
Laryngoskopspatel, McIntosh .....391  
Laryngoskopspatel, Miller .....389  
Lawrence, Präparierklemme .....203  
Leberhaken, Mikulicz .....273  
Leberpunktionskanüle, Menghini.....384  
Leksell-Stille, Hohlmeißelzange .....528  
Lempert, Hohlmeißelzange .....523  
Lempert, Mikro-Ohr Raspatorium .....679  
Lempert, Ohrlöffel .....679  
Lerliche, Arterienklemme .....173  
Lewin, Knochenhalte-zange .....512  
Lewis, Nasenraspel .....712  
Lexter, Hohlmeißel .....465  
Lexter, Osteotom .....465  
Lexter, Präparierschere.....46-48, 51, 115  
Lexter, Spongiosaentnahmemeißel .....463  
Lexter-Baby, Präparierschere .....51  
Lexter-Fino, Feine Präparierschere.....52  
Lexter-Mini, Hohlmeißel .....464  
Lexter-Mini, Osteotom .....464  
Ligaturschere.....111-112  
Lister, Sinusklemme .....219  
Lister, Verbandschere .....442, 446  
Liston, Amputationsmesser .....13  
Liston, Knochensplitterzange.....530  
Liston-Key, Knochensplitterzange.....534  
Littauer, Cilienpinzette.....155  
Littauer, Fadenschere .....108  
Little, Wundhaken .....246  
Locklin, Zahnfleissschere .....94  
Lockwood, Darm- und Gewebefasszange .....557  
Lorenz, Verbandschere .....442  
Lorna, Tuchklemme.....212  
Lovelace, Arterienklemme .....176

|   |                   |   |                        |  |               |
|---|-------------------|---|------------------------|--|---------------|
| Lower, Präparierklemme.....                             | 198               | McDonald, Doppeldissektor.....                  | 501                    | Miller-Baby, Laryngoskopiebesteck..... | 389           |
| Low-Profile, Feder.....                                 | 302               | McGee, Drahtbiegezüngchen.....                  | 656                    | Miller-Colburn, Knochenfeile.....      | 498-499       |
| Low-Profile, Mittelvalve.....                           | 302               | McGee, Mikro-Ohrhäkchen.....                    | 661                    | Milligan, Wundspreizer.....            | 292           |
| Low-Profile, Wundspreizer.....                          | 302               | McGinvey, Haemorrhoiden-Fasszange.....          | 582                    | Millin, Blasenhalssperrerr.....        | 592           |
| Lubet-Barbon, Nasentamponzange.....                     | 686               | McIndoe, Anatomische Pinzette.....              | 128, 131               | Millin, Blasenwundsperrerr.....        | 593           |
| Lucae, Ersatzknopf.....                                 | 668               | McIntosh, Kaltlicht-Laryngoskopiebesteck.....   | 394                    | Millin, Kapselfasszange.....           | 590-591       |
| Lucae, Fuss.....  | 668               | McIntosh, Kaltlicht-Laryngoskopspatel.....      | 394-395                | Millin, Mittelvalve.....               | 593           |
| Lucae, Hammer.....                                      | 476               | McIntosh, Laryngoskopiebesteck.....             | 391                    | Millin, Seitenvalve.....               | 593           |
| Lucae, Ohrhäkchen.....                                  | 677               | McIntosh, Laryngoskopspatel.....                | 391                    | Mini-Adson, Anatomische Pinzette.....  | 128           |
| Lucae, Parazentesenadel.....                            | 678               | McKenty, Septumlevatorium.....                  | 701-702                | Mini-Adson, Chirurgische Pinzette..... | 143           |
| Lucae, Stimmgabel.....                                  | 668               | McQuigg-Mixer, Präparierklemme.....             | 197                    | Mini-Gefäßclip.....                    | 161           |
| Luer, Hohlmeißelzange.....                              | 525               | Mead, Ersatzbacken.....                         | 477                    | Mini-Gemini, Präparierklemme.....      | 192           |
| Luer, Saugrohr.....                                     | 369               | Mead, Hammer.....                               | 477                    | Mini-Glover, Bulldogklemme.....        | 165-166       |
| Luer, Trachealhaken.....                                | 549               | Mead, Hohlmeißelzange.....                      | 523                    | Mini-Glover, Clip-Anlegezange.....     | 166           |
| Luer-Körte, Gallensteinlöffel.....                      | 588               | Meeker, Präparierklemme.....                    | 203                    | Mini-McGee, Mikro-Ohrzängchen.....     | 649, 653      |
| Lukens, Thymushaken.....                                | 549               | Mehrzweckschale.....                            | 758                    | Mini-Phlebextraktor, Varady.....       | 352           |
| Lumbalpunktionkanüle, Tuohy.....                        | 382               | Meißel, Fomon.....                              | 707                    | Mittelvalve, Alan-Parks.....           | 580           |
| Luniatschek, Tamponstopfer.....                         | 728               | Meißelgriff.....                                | 462                    | Mittelvalve, Balfour.....              | 313           |
| <b>M</b>  |                   | Meißelklinge.....                               | 462                    | Mittelvalve, Balfour-Standard.....     | 312, 314-315  |
| M. G. Hospital, Nadelhalter.....                        | 411               | Menghini, Leberpunktionkanüle.....              | 384                    | Mittelvalve, Collin.....               | 305-306       |
| Magen und Darm-Zwillingsklemmen, Lane.....              | 568-569           | Messbecher.....                                 | 757                    | Mittelvalve, Gosset.....               | 310           |
| Magill, Kathetereinführzange.....                       | 388               | Messer, Virchow.....                            | 3                      | Mittelvalve, Henley.....               | 293           |
| Maltz, Nasenraspel.....                                 | 711, 713          | Meßzirkel, Castroviejo.....                     | 644                    | Mittelvalve, Low-Profile.....          | 302           |
| Marquard, Hohlmeißelzange.....                          | 526               | Meßzirkel, Castroviejo-Epker.....               | 644                    | Mittelvalve, Millin.....               | 593           |
| Martel-Rees, Face-Lift Klemme.....                      | 170               | Metallkatheter für Frauen.....                  | 595                    | Mittelvalve, O'Sullivan-O'Connor.....  | 316           |
| Martin aquajet, Reinigungsaufsatz.....                  | 762-763           | Metallstößel.....                               | 474                    | Mittelvalve, Ricard.....               | 307           |
| Martin aquajet, Wasserstrahl-<br>Reinigungspistole..... | 762               | Metallstößel, Caspar.....                       | 474                    | Mixer, Gallensteinzange.....           | 587           |
| Martin, Abfallzange.....                                | 768               | Metzenbaum, Nadelhalter.....                    | 410                    | Mixer, Präparierklemme.....            | 195-197       |
| Martin, Bauchspatel.....                                | 348               | Metzenbaum, Präparierschere.....                | 37-44                  | Mixer-Baby, Präparierklemme.....       | 170, 186, 194 |
| Martin, Beckenzirkel.....                               | 638               | Metzenbaum-Fino,<br>Feine Präparierschere.....  | 53-58, 113, 117        | Mock, Heprainnadel.....                | 381, 384      |
| Martin, Bürstenspender.....                             | 742-743           | Metzenbaum-Lahey, Feine Präparierschere.....    | 117                    | Mod. Bonn, Irischere.....              | 96            |
| Martin, Drahtschere.....                                | 124               | Metzenbaum-Nelson, Präparierschere.....         | 40                     | Mod. Martin, Bruchsonde.....           | 436           |
| Martin, Gipsmesser.....                                 | 447               | Metzenbaum-Thorek, Präparierschere.....         | 115                    | Mod. Martin, Kappenzange.....          | 754           |
| Martin, Knorpelfasszange.....                           | 512               | Meyerding, Wundhäkchen.....                     | 230                    | Mod. München, Biopsiekürette.....      | 627           |
| Martin, Korn- u. Tupferzange.....                       | 219               | Michel, Kehlkopfspiegel.....                    | 735                    | Mod. USA, Nabelschnurschere.....       | 90            |
| Martin, Martin-Arm-System '99.....                      | 322               | Michel, Wundklammerpinzette.....                | 439                    | Mod. Wien, Nasenspekulum.....          | 682           |
| Martin, Nadelhalter.....                                | 423               | Michel, Wundklammerzange.....                   | 440                    | Modell USA, Scharfer Löffel.....       | 485           |
| Martin, Nasenspekulum.....                              | 681               | Microvascular, Nadelhalter.....                 | 426                    | Modell Wien, Fadenfänger.....          | 438           |
| Martin, Stimmgabel.....                                 | 667               | Middeldorf, Wundhaken.....                      | 252, 256               | Mogen, Beschneidungsinstrument.....    | 596           |
| Martin, Universal-Befestigungskloben.....               | 322, 323          | Middleton-Jansen, Septumzange.....              | 694                    | Mollison, Wundspreizer.....            | 289           |
| Martin, Wundhaken.....                                  | 259               | Mikro-Adson, Anatomische Pinzette.....          | 143                    | Molt, Doppelkürette.....               | 487           |
| Martin, Wundspreizer.....                               | 301               | Mikro-Adson, Chirurgische Pinzette.....         | 143                    | Moynihan, Hysterektomieklammer.....    | 207           |
| Martin-Alloy, Stimmgabel.....                           | 667               | Mikro-Adson, Chirurgische Pinzette.....         | 143                    | Mukosahäkchen, Freer.....              | 716           |
| Martin-Arm-System '99, Martin.....                      | 322               | Mikro-Adson, Präparierklemme.....               | 170                    | Mukosahäkchen, Joseph.....             | 715-716       |
| Martin-Aseptic, Handwaschbürste.....                    | 742               | Mikro-Adson, Präparierklemme.....               | 143                    | Mukosamesser, Freer.....               | 700           |
| Martin-Cushing, Raspatorium.....                        | 489               | Mikro-Adson, Shigeno, Anatomische Pinzette..... | 143                    | Museux, Hakenzange.....                | 621           |
| Martin-Fuchsig, Präparierklemme.....                    | 177               | Mikro-Dissektor, Fisch.....                     | 662                    | Myomheber, Doyen.....                  | 624           |
| Martin-Hoen, Raspatorium.....                           | 488               | Mikrodissektor, Varady.....                     | 352                    | Myommesser, Segond.....                | 624           |
| Martini, Nadelhalter.....                               | 426-427           | Mikro-Gefäßhäkchen.....                         | 228                    | Myrtenblattsonde.....                  | 350           |
| Martin-Langenbeck, Elevatorium.....                     | 500               | Mikro-Gewichts-Pinzette.....                    | 150                    |  |               |
| Martin-Langenbeck, Raspatorium.....                     | 488               | Mikrohäkchen, Graefe.....                       | 226                    | <b>N</b>                               |               |
| Martin-Rochard, Hakenhalterung.....                     | 323               | Mikrohäkchen, Rasse.....                        | 226                    | Nabatoff, Kunststoffspitze.....        | 353           |
| Martin-Rochard, Hakensystem.....                        | 323               | Mikro-Kürette, House.....                       | 663                    | Nabatoff, Olive.....                   | 353           |
| Martin-Rochard, Haltearm.....                           | 323               | Mikro-Messsonde, House.....                     | 663                    | Nabatoff, T-Griff.....                 | 353           |
| Martin-Rochard, Querstab.....                           | 323               | Mikro-Mosquito, Arterienklammer.....            | 173                    | Nabatoff, Varizenbesteck.....          | 353           |
| Martin-Rochard, Schiebekloben.....                      | 323               | Mikro-Nadelhalter.....                          | 404-405, 415, 417      | Nabatoff, Zugseil.....                 | 353           |
| Martin-Rochard, Wundhaken.....                          | 323               | Mikro-Nadelhalter, Barraquer.....               | 406-407, 419           | Nabelschnurklammer, Collin.....        | 642           |
| marTract.....   | 326-339, 341, 345 | Mikro-Nadelhalter, Barraquer-Troutman.....      | 406                    | Nabelschnurschere, Busch.....          | 90            |
| marTract, Alan-Parks.....                               | 338               | Mikro-Nadelhalter, Castroviejo.....             | 408, 418-419           | Nabelschnurschere, Mod. USA.....       | 90            |
| marTract, Breisky.....                                  | 340               | Mikro-Nadelhalter, Castroviejo-Fino.....        | 407                    | Nabelschnurschere, Schuhmacher.....    | 90            |
| marTract, Deaver.....                                   | 337               | Mikro-Nadelhalter, Heavy Duty.....              | 416                    | Nadeldose.....                         | 751-753       |
| marTract, Harrington.....                               | 339               | Mikro-Nadelhalter, Hepp-Scheidel.....           | 415                    | Nadeletui, Sauerbruch.....             | 751           |
| marTract, Kirschner.....                                | 334               | Mikro-Ohr-Raspatorium, Lempert.....             | 679                    | Nadelhalter, Adson.....                | 410           |
| marTract, Langenbeck.....                               | 335-336, 339      | Mikro-Ohrhäkchen.....                           | 661-662                | Nadelhalter, Bozemann.....             | 425           |
| marTract, Richardson.....                               | 342               | Mikro-Ohrhäkchen, Barbara.....                  | 660                    | Nadelhalter, Brown.....                | 410           |
| marTract, Roux.....                                     | 344               | Mikro-Ohrhäkchen, McGee.....                    | 661                    | Nadelhalter, Collier.....              | 409           |
| marTract, St. Marks.....                                | 343               | Mikro-Ohrhäkchen, Shambaugh.....                | 662                    | Nadelhalter, Crile.....                | 414           |
| marTract, Volkmann.....                                 | 344               | Mikro-Ohrnadel, Barbara.....                    | 660-661                | Nadelhalter, Crile-Murray.....         | 410           |
| Masing, Periostelevatorium.....                         | 704               | Mikro-Ohrnadel, Rosen.....                      | 660                    | Nadelhalter, Crile-Wood.....           | 410, 415, 420 |
| Masson, Nadelhalter.....                                | 412, 422          | Mikro-Ohrnaspatorium, Rosen.....                | 662                    | Nadelhalter, DeBakey.....              | 422           |
| Mastdarm-Rektum-Spekulum, Czerny.....                   | 579               | Mikro-Ohrscherchen, Bellucci.....               | 654                    | Nadelhalter, Derf.....                 | 409, 419      |
| Mastdarm-Rektum-Spekulum, Pratt.....                    | 579               | Mikro-Ohrscherchen, Wullstein.....              | 655                    | Nadelhalter, Finocchio.....            | 412, 423      |
| Mastdarm-Rektum-Spekulum, Sims.....                     | 579               | Mikro-Ohrzängchen.....                          | 648, 650-652           | Nadelhalter, Foster-Gillies.....       | 428           |
| Mathieu, Fremdkörperzange.....                          | 597               | Mikro-Ohrzängchen, Mini-McGee.....              | 649, 653               | Nadelhalter, Gillies.....              | 414, 428      |
| Mathieu, Nadelhalter.....                               | 414, 428-429      | Mikro-Phlebextraktor, Varady.....               | 352                    | Nadelhalter, Gillies-Mini.....         | 428           |
| Mathieu, Wundhaken.....                                 | 279               | Mikropinzette.....                              | 129, 141, 149-152, 158 | Nadelhalter, Halsey.....               | 409, 420      |
| Mayfield, Hohlmeißelzange.....                          | 526               | Mikropinzette, Jeweler mod.....                 | 150                    | Nadelhalter, Heaney.....               | 411, 422      |
| Mayo, Chirurgische Pinzette.....                        | 146               | Mikro-Ringpinzette.....                         | 150-152                | Nadelhalter, Hegar.....                | 425           |
| Mayo, Chirurgische Schere.....                          | 24-25             | Mikroschere.....                                | 76, 104-105            | Nadelhalter, Hegar-Baumgartner.....    | 410, 420      |
| Mayo, Sterilisierklammer.....                           | 754               | Mikroschere, Biemer.....                        | 105                    | Nadelhalter, Hegar-Vascular.....       | 425           |
| Mayo-Blake, Gallensteinzange.....                       | 586               | Mikroschere, Jaboma.....                        | 105                    | Nadelhalter, Jaboma.....               | 415           |
| Mayo-Harrington, Präparierschere.....                   | 29                | Mikulicz, Leberhaken.....                       | 273                    | Nadelhalter, Jameson.....              | 412           |
| Mayo-Hegar, Nadelhalter.....                            | 411, 421          | Mikulicz, Peritoneumklammer.....                | 209-210                | Nadelhalter, Johnson.....              | 413           |
| Mayo-Lexer, Präparierschere.....                        | 116               | Mikulicz, Wundhaken.....                        | 272                    | Nadelhalter, Kilner.....               | 419           |
| Mayo-Noble, Präparierschere.....                        | 29                | Mikulicz-Baby, Peritoneumklammer.....           | 209                    | Nadelhalter, Kübler.....               | 430           |
| Mayo-Robson, Darmklammer.....                           | 562, 572          | Miller, Kaltlicht-Laryngoskopiebesteck.....     | 398                    | Nadelhalter, Langenbeck.....           | 430           |
| Mayo-Stille, Präparierschere.....                       | 26-28             | Miller, Kaltlicht-Laryngoskopspatel.....        | 398-399                | Nadelhalter, Martin.....               | 411           |
|   |                   | Miller, Knochenfeile.....                       | 499                    | Nadelhalter, Miller.....               | 423           |
|   |                   | Miller, Laryngoskopiebesteck.....               | 389                    | Nadelhalter, Martini.....              | 426-427       |
|   |                   | Miller, Laryngoskopspatel.....                  | 389                    |  |               |

- Nadelhalter, Masson ..... 412, 422  
 Nadelhalter, Mathieu ..... 414, 428-429  
 Nadelhalter, Mayo-Hegar ..... 411, 421  
 Nadelhalter, Metzenbaum ..... 410  
 Nadelhalter, Microvascular ..... 426  
 Nadelhalter, Neivert ..... 409  
 Nadelhalter, Olsen Hegar ..... 414, 427  
 Nadelhalter, Par-Style ..... 416  
 Nadelhalter, Ryder (Martin) ..... 423  
 Nadelhalter, Ryder-Vascular ..... 424  
 Nadelhalter, Sarot ..... 421  
 Nadelhalter, Stratte ..... 413, 426  
 Nadelhalter, Toennis ..... 429  
 Nadelhalter, Wangenstein ..... 413, 424  
 Nadelhalter, Webster ..... 409, 415, 419  
 Nägele, Geburtszange ..... 638  
 Nagelackenzange ..... 745  
 Nagelfeile ..... 745  
 Nagelhautschere ..... 745  
 Nagelhautzange ..... 745  
 Nagelschere ..... 744  
 Nagelzange ..... 744  
 Nasenflügelhäkchen, Converse ..... 716  
 Nasenflügelhäkchen, Cottle ..... 717  
 Nasenflügelhäkchen, Cottle-Neivert ..... 717  
 Nasenflügelhäkchen, Fomon ..... 715-716  
 Nasenflügelhäkchen, Kilner ..... 716  
 Nasenflügelhäkchen, Lange ..... 715  
 Nasenflügelhäkchen, Neivert ..... 717  
 Nasenflügelhäkchen, Cottle ..... 715  
 Nasenhaken, Aufrecht ..... 715, 717  
 Nasenhaken, Converse ..... 716  
 Nasenhaken, Cottle ..... 717  
 Nasenmeißel, Silver ..... 708  
 Nasenpolypenzange, Hartmann ..... 686  
 Nasenraspel, Cottle ..... 711  
 Nasenraspel, Fomon ..... 712, 714  
 Nasenraspel, Lewis ..... 712  
 Nasenraspel, Maltz ..... 711, 713  
 Nasensäge, Joseph ..... 709  
 Nasenschere, Cinelli ..... 50  
 Nasenschere, Converse ..... 88  
 Nasenschere, Cottle ..... 85  
 Nasenschere, Fomon ..... 50, 83-84  
 Nasenschere, Heymann ..... 86-87  
 Nasenspekulum, Cottle ..... 682-683  
 Nasenspekulum, Goldsmith (Thudichum) ..... 680  
 Nasenspekulum, Hartmann-Halle ..... 680  
 Nasenspekulum, Killian ..... 681  
 Nasenspekulum, Martin ..... 681  
 Nasenspekulum, Mod. Wien ..... 682  
 Nasenspekulum, Tieck-Halle ..... 681  
 Nasentamponpinzette, Grünwald (Jansen) ..... 686  
 Nasentamponpinzette, Trölsch ..... 686  
 Nasentamponzange, Lubet-Barbon ..... 686  
 Nasentamponzange, Westmacott ..... 686  
 Negus, Arterienklemme ..... 203  
 Neivert, Nadelhalter ..... 409  
 Neivert, Nasenflügelhäkchen ..... 717  
 Neivert-Anderson, Osteotom ..... 708  
 Nelaton, Hohlsonde ..... 351  
 Nelson, Chirurgische Pinzette ..... 147  
 Neuro, Stimmgabel ..... 669  
 Neurochirurgische Schere, Strully ..... 77  
 Nierenschale ..... 760  
 Nierensteinzange, Heiming ..... 584  
 Nierensteinzange, Randall ..... 584  
 Nierenstielklemme, Guyon ..... 199-200  
 Norfolk-Norwich, Wundspreizer ..... 283  
 Northbent, Fadenschere ..... 107  
 Noto, Uteruspolypenzange ..... 623  
 Novak, Saugkürette ..... 627  
 Nuboer, Sauger ..... 377
- O**  
 O'Brian, Fadenschere ..... 107  
 O'Connor, Hauthäkchen ..... 227  
 O'Shaughnessy, Präparierklemme ..... 195  
 O'Sullivan-O'Connor, Bauchdeckenhalter ..... 316  
 O'Sullivan-O'Connor, Mittelvalve ..... 316  
 Obturator, Guilen ..... 720  
 Ochsner, Fadenpinzette ..... 438  
 Oehler, Chirurgische Pinzette ..... 134  
 Ogura, Hautfasspinzette ..... 719  
 Ohrhäkchen, Day ..... 678  
 Ohrhäkchen, Hartmann ..... 677  
 Ohrhäkchen, Lucae ..... 677  
 Ohrhäkchen, Wagoner ..... 678  
 Ohrkatheter, Hartmann ..... 670  
 Ohr-Knochenstanze, Beyer ..... 675  
 Ohr-Knochenstanze, Citelli ..... 674  
 Ohrkürette, Buck ..... 676  
 Ohrkürette, Shapleigh ..... 676  
 Ohröffel und Häkchen, Gross ..... 677  
 Ohröffel, Jansen ..... 677  
 Ohröffel, Lempert ..... 679  
 Ohrpinzette, Grünwald ..... 671  
 Ohrpinzette, Jansen ..... 671  
 Ohrpinzette, Trölsch (Wilde) ..... 671  
 Ohrpolypenzange, Hartmann ..... 672-673  
 Ohrpolypenzange, Hartmann-Herzfeld ..... 673  
 Ohrpolypenzange, Hartmann-Hoffmann ..... 673  
 Ohrpolypenzange, Hartmann-Wullstein ..... 673  
 Ohrpolypenzange, Strümpel ..... 673  
 Ohrschiinge, Billeau ..... 677  
 Ohrschiinge, Weber-Loch ..... 677  
 Ohrspekula, Satz, Hartmann ..... 664  
 Ohrspekula, Satz, Toynbee ..... 664  
 Ohrspekulaständer ..... 665  
 Ohrspekulum, Farrior ..... 665  
 Ohrspekulum, Hartmann ..... 664  
 Ohrspekulum, Toynbee ..... 664  
 Olive, Nabatoff ..... 353  
 Olivecrona, Präparierschere ..... 79  
 Ollier, Wundhaken ..... 240  
 Olsen Hegar, Nadelhalter ..... 414, 427  
 Organfasszange ..... 168  
 Organfasszange, Collin ..... 169  
 Organfasszange, Scheibe ..... 570  
 Osteotom ..... 456  
 Osteotom, Cinelli ..... 708  
 Osteotom, Cottle ..... 706  
 Osteotom, Hibbs ..... 471-472  
 Osteotom, Hoke ..... 471  
 Osteotom, Lambotte ..... 467-468  
 Osteotom, Lambotte-Mini ..... 466  
 Osteotom, Lexer ..... 465  
 Osteotom, Lexer-Mini ..... 464  
 Osteotom, Neivert-Anderson ..... 708  
 Osteotom, Rubin ..... 707  
 Osteotom, Smith-Petersen ..... 469  
 Osteotom, Stille ..... 460-461  
 Osteotom, Walter ..... 707  
 Osteotomklinge ..... 462  
 Oszillierende Gipszange ..... 450  
 Overholt, Präparierklemme ..... 191  
 Overholt-Baby, Präparierklemme ..... 175  
 Overholt-Fino, Präparierklemme ..... 190  
 Overholt-Geissendörfer, Präparierklemme ..... 189  
 Overholt-Martin, Präparierklemme ..... 185  
 Overholt-Mini, Präparierklemme ..... 191  
 Overholt-Mixter, Präparierklemme ..... 186
- P**  
 Paar Schläuche allein, Strauss ..... 598  
 Parametriumklemme, Rogers ..... 206  
 Parazentesenadel, Lucae ..... 678  
 Parazentesenadel, Politzer ..... 678  
 Parker, Wundhaken ..... 278  
 Parker-Langenbeck, Wundhaken ..... 279  
 Parker-Mott, Wundhaken ..... 278  
 Par-Style, Nadelhalter ..... 416  
 Partsch, Flachmeißel ..... 458  
 Partsch, Hammer ..... 478  
 Partsch, Hohlmeißel ..... 458  
 Payr, Darmquetschklemme ..... 565  
 Payr, Führungshohlsonde ..... 438  
 Payr-Baby, Darmquetschklemme ..... 565  
 Pean (Rochester), Arterienklemme ..... 181-182  
 Pean, Arterienklemme ..... 167, 178  
 Pean-Nippon, Arterienklemme ..... 178  
 Peck-Joseph, Face-lift Schere ..... 62-63  
 Pederson, Vaginalspekulum ..... 601  
 Peers-Bertram modif., Tuckklemme ..... 212  
 Peers-Bertram, Tuckklemme ..... 213  
 Peet, Splitterzange ..... 156  
 Penisklemme, Stockmann ..... 598  
 Penisklemme, Strauss ..... 598  
 Pennington, Arterienklemme ..... 169  
 Pennington, Septumelelevatorium ..... 704  
 Percy, Amputationretractor ..... 521  
 Periostelevatorium, Cottle ..... 704  
 Periostelevatorium, Joseph ..... 704  
 Periostelevatorium, Joseph-Masing ..... 704  
 Periostelevatorium, Masing ..... 704  
 Peritoneumklemme, Faure ..... 210  
 Peritoneumklemme, Mikulicz ..... 209-210  
 Peritoneumklemme, Mikulicz-Baby ..... 209  
 Pestalozza, Abortuskürette ..... 642  
 Phalangenzange ..... 512  
 Phaneuf, Hysterektomieklammer ..... 204  
 Phlebextraktor, Varady ..... 352  
 Phlebodissektor, Varady ..... 352  
 Piper, Geburtszange ..... 639  
 Plester, Lappenmesser ..... 659  
 Plester, Saugkanüle ..... 383  
 Plester, Wundspreizer ..... 290  
 Politzer, Parazentesenadel ..... 678  
 Polypenschnürer, Krause ..... 670, 684  
 Polypenschnürer, Krause-Voss ..... 670, 684  
 Poole, Sauger ..... 373  
 Poppen, Sauger ..... 367  
 Potts-Smith, Anatomische Pinzette ..... 130, 133  
 Potts-Smith, Chirurgische Pinzette ..... 142  
 Potts-Smith, Gefäßschere ..... 74-75  
 Präparierklemme, Meeker ..... 177  
 Präparierklemme, Adson-Baby ..... 186  
 Präparierklemme, Baby-Adson ..... 170  
 Präparierklemme, Crafoord ..... 188  
 Präparierklemme, Finochietto ..... 198  
 Präparierklemme, Gemini ..... 192  
 Präparierklemme, Heiss ..... 186  
 Präparierklemme, Kelly ..... 202  
 Präparierklemme, Lawrence ..... 203  
 Präparierklemme, Lower ..... 198  
 Präparierklemme, Martin-Fuchsig ..... 177  
 Präparierklemme, McQuigg-Mixter ..... 197  
 Präparierklemme, Meeker ..... 203  
 Präparierklemme, Mikro-Adson ..... 170  
 Präparierklemme, Mini-Gemini ..... 192  
 Präparierklemme, Heiss ..... 195-197  
 Präparierklemme, Mixter-Baby ..... 170, 186, 194  
 Präparierklemme, O'Shaughnessy ..... 195  
 Präparierklemme, Overholt ..... 191  
 Präparierklemme, Overholt-Baby ..... 175  
 Präparierklemme, Overholt-Fino ..... 190  
 Präparierklemme, Overholt-Geissendörfer ..... 189  
 Präparierklemme, Overholt-Martin ..... 185  
 Präparierklemme, Overholt-Mini ..... 191  
 Präparierklemme, Overholt-Mixter ..... 186  
 Präparierklemme, Roberts ..... 187  
 Präparierklemme, Rumel ..... 193  
 Präparierklemme, Sarot ..... 187  
 Präparierklemme, Schmidt ..... 177  
 Präparierklemme, Zinkstroom ..... 196  
 Präparierklemme, Wacker ..... 194  
 Präparierschere ..... 44, 59, 64  
 Präparierschere, DeBakey ..... 49  
 Präparierschere, Diethrich-Salyer ..... 72  
 Präparierschere, Hohenfellner ..... 49  
 Präparierschere, Jameson ..... 69  
 Präparierschere, Kilner ..... 65  
 Präparierschere, Knapp ..... 114  
 Präparierschere, Kübler ..... 44  
 Präparierschere, Lexer ..... 46-48, 51, 115  
 Präparierschere, Lexer-Baby ..... 51  
 Präparierschere, Mayo-Harrington ..... 29  
 Präparierschere, Mayo-Lexer ..... 116  
 Präparierschere, Mayo-Noble ..... 29  
 Präparierschere, Mayo-Stille ..... 26-28  
 Präparierschere, Metzenbaum ..... 37-44  
 Präparierschere, Metzenbaum-Nelson ..... 40  
 Präparierschere, Metzenbaum-Thorek ..... 115  
 Präparierschere, Olivecrona ..... 79  
 Präparierschere, Ragnell ..... 123  
 Präparierschere, Reynolds ..... 67-68  
 Präparierschere, Salyer ..... 59, 107  
 Präparierschere, Shea Vein Graft ..... 64  
 Präparierschere, Thorek ..... 50  
 Pratt, Mastdarm-Rektum-Spekulum ..... 579  
 Probeexzisionszange, Alexander ..... 631  
 Probeexzisionszange, Faure ..... 628  
 Probeexzisionszange, Gellhorn ..... 628  
 Probeexzisionszange, Kevorkian ..... 631  
 Probeexzisionszange, Schubert ..... 628-629  
 Probeexzisionszange, Schumacher ..... 631-632  
 Probeexzisionszange, Thoms-Gaylor ..... 629  
 Probeexzisionszange, Van Doren ..... 630  
 Prostatahaken, Young ..... 589  
 Providence-Hospital, Arterienklemme ..... 173  
 Pudendusnästhesie-Kanüle ..... 381  
 Putti, Knochenraspel ..... 473  
 Pylorusspreizer, Benson ..... 567

# Index, alphabetisch

## Deutsch

|  |               |  |  |
|--|---------------|--|--|
| <b>Q</b>                                 |               |  |  |
| Quattro, Gipsspreizer                    | 448           |  |  |
| Querstab, Martin-Rochard                 | 323           |  |  |
| Quervain, Elevatorium                    | 501           |  |  |
| <b>R</b>                                 |               |  |  |
| Ragnell, Präparierschere                 | 123           |  |  |
| Ragnell-Davis, Wundhäkchen               | 231           |  |  |
| Rahmen, Kirschner                        | 317-319       |  |  |
| Rahmen, Ricard                           | 307           |  |  |
| Rahmenhaken, Kirschner                   | 317-319       |  |  |
| Rampléy, Schwammzange                    | 223           |  |  |
| Randall, Nierensteinzange                | 584           |  |  |
| Rändelmutter                             | 518           |  |  |
| Rändelschraube, Rydel-Seiffert           | 669           |  |  |
| Raspatorium                              | 493-494       |  |  |
| Raspatorium, Cobb                        | 492           |  |  |
| Raspatorium, Cottle                      | 490           |  |  |
| Raspatorium, Farabeuf                    | 491           |  |  |
| Raspatorium, Farabeuf-Collin             | 491           |  |  |
| Raspatorium, Kahre-Williger              | 494           |  |  |
| Raspatorium, Key                         | 491           |  |  |
| Raspatorium, König                       | 490           |  |  |
| Raspatorium, Lambotte                    | 496           |  |  |
| Raspatorium, Landolt                     | 490           |  |  |
| Raspatorium, Langenbeck                  | 490           |  |  |
| Raspatorium, Martin-Cushing              | 489           |  |  |
| Raspatorium, Martin-Hoen                 | 488           |  |  |
| Raspatorium, Martin-Langenbeck           | 488           |  |  |
| Raspatorium, Sedillot                    | 490           |  |  |
| Raspatorium, Semb                        | 496           |  |  |
| Raspatorium, Williger                    | 494           |  |  |
| Rasse, Knochenhäkchen                    | 226           |  |  |
| Rasse, Mikrohäkchen                      | 226           |  |  |
| Recamier, Uteruskürette                  | 634           |  |  |
| Redon, Redon-Führungsnadel               | 379-380       |  |  |
| Redon-Führungsnadel, Redon               | 379-380       |  |  |
| Rees, Face-Lift Schere                   | 119           |  |  |
| Reinigungsaufsatz, Martin aquajet        | 762-763       |  |  |
| Reinigungsbürste                         | 764-767       |  |  |
| Rektum-Anastomosenklemme, Fehland        | 577           |  |  |
| Rektum-Anastomosenklemme, Hayes          | 576           |  |  |
| Rektum-Anastomosenklemme, Resano         | 578           |  |  |
| Rektum-Anastomosenklemme, Veidenheimer   | 577           |  |  |
| Rektum-Anastomosenklemmen, Brunner       | 575           |  |  |
| Repositionszange                         | 512, 514      |  |  |
| Resano, Chirurgische Pinzette            | 147           |  |  |
| Resano, Rektum-Anastomosenklemme         | 578           |  |  |
| Resektionsmesser                         | 13            |  |  |
| Reynolds, Präparierschere                | 67-68         |  |  |
| Rhinoplastikmesser, Converse             | 699           |  |  |
| Rhinoplastikmesser, Cottle               | 699           |  |  |
| Rhinoplastikmesser, Fomon                | 699           |  |  |
| Rhinoplastikmesser, Joseph               | 699           |  |  |
| Ricard, Bauchdeckenhalter                | 307           |  |  |
| Ricard, Mittelvalve                      | 307           |  |  |
| Ricard, Rahmen                           | 307           |  |  |
| Richardson, marTract                     | 342           |  |  |
| Richardson, Wundhaken                    | 253           |  |  |
| Richardson-Eastman, Wundhaken            | 252           |  |  |
| Richter, Wundklammerzange                | 440           |  |  |
| Ringmesser, Beckmann                     | 720           |  |  |
| Ringstripper, Vollmar                    | 354           |  |  |
| Rippenraspatorium, Doyen                 | 495           |  |  |
| Ritter-Halle, Dilatationssonde           | 720           |  |  |
| Roberts, Präparierklemme                 | 187           |  |  |
| Rochester-Carmalt, Arterienklemme        | 177           |  |  |
| Roeder, Tuchklemme                       | 212           |  |  |
| Roger, Septumlevatorium                  | 704           |  |  |
| Rogers, Parametriumklemme                | 206           |  |  |
| Rollenklemme, Brompton                   | 215           |  |  |
| Rollenklemme, Gunnar-Hey                 | 215           |  |  |
| Rose, Trachealhaken                      | 549           |  |  |
| Rosen, Mikro-Ohrnadel                    | 660           |  |  |
| Rosen, Mikro-Ohrspatorium                | 662           |  |  |
| Rosen, Rundschnittmesser                 | 659           |  |  |
| Ross, Aortahaken                         | 265           |  |  |
| Roux, marTract                           | 344           |  |  |
| Roux, Wundhaken                          | 276           |  |  |
| Roux-Baby, Wundhaken                     | 277           |  |  |
| Roux-Mini, Wundhaken                     | 277           |  |  |
| Rubin, Osteotom                          | 707           |  |  |
| Rubin, Schutzkappe                       | 695           |  |  |
| Rubin, Septumquetschzange                | 695           |  |  |
| Rumel, Präparierklemme                   | 193           |  |  |
| Rundschnittmesser, Rosen                 | 659           |  |  |
| Ruskin, Hohlmeißelzange                  | 526           |  |  |
| Ruskin-Liston, Knochensplitterzange      | 532           |  |  |
| Russ, Modell, Chirurgische Pinzette      | 145           |  |  |
| Rydel-Seiffert, Dämpfer                  | 669           |  |  |
| Rydel-Seiffert, Gewichte                 | 669           |  |  |
| Rydel-Seiffert, Rändelschraube           | 669           |  |  |
| Rydel-Seiffert, Stimmgabel               | 669           |  |  |
| Ryder (Martin), Nadelhalter              | 423           |  |  |
| Ryder-Vascular, Nadelhalter              | 424           |  |  |
| <b>S</b>                                 |               |  |  |
| Sägeblatt                                | 450           |  |  |
| Salzer, Face-lift Schere                 | 107           |  |  |
| Salzer, Gaumenspaltdissektor             | 726           |  |  |
| Salzer, Gaumenspaltenlevatorium          | 726           |  |  |
| Salzer, Gaumenspaltenhaken               | 726           |  |  |
| Salzer, Präparierschere                  | 59, 107       |  |  |
| Sänger, Abortuszange                     | 640           |  |  |
| Sanvenero, Chirurgische Schere           | 59            |  |  |
| Sarot, Nadelhalter                       | 421           |  |  |
| Sarot, Präparierklemme                   | 187           |  |  |
| Satinsky, Gefäßschere                    | 71            |  |  |
| Sattelhäkchen, Cottle                    | 717           |  |  |
| Sattelhäkchen, Cushing                   | 232           |  |  |
| Sattelhäkchen, Desmarres                 | 229           |  |  |
| Sattelhäkchen, Gil-Vernet                | 233           |  |  |
| Sauerbruch, Abfallzange                  | 768           |  |  |
| Sauerbruch, Nadeletui                    | 751           |  |  |
| Sauerbruch, Wundhaken                    | 264           |  |  |
| Saugadapter, House                       | 374           |  |  |
| Saugaufsatz, Wullstein                   | 368           |  |  |
| Saugaufsatz, Zoellner                    | 368           |  |  |
| Sauger, Cooley                           | 362-363-376   |  |  |
| Sauger, Adson                            | 364           |  |  |
| Sauger, Baby-Poole                       | 373           |  |  |
| Sauger, Baby-Yankauer                    | 371           |  |  |
| Sauger, Baron-Schuknecht                 | 369           |  |  |
| Sauger, Cogswell                         | 378           |  |  |
| Sauger, Cooley                           | 375           |  |  |
| Sauger, De Bakey-Adson                   | 371           |  |  |
| Sauger, Fergusson                        | 365-366       |  |  |
| Sauger, Frazier                          | 364           |  |  |
| Sauger, House                            | 374           |  |  |
| Sauger, Jamieson                         | 377           |  |  |
| Sauger, Landolt                          | 370           |  |  |
| Sauger, Nuboer                           | 377           |  |  |
| Sauger, Poole                            | 373           |  |  |
| Sauger, Poppen                           | 367           |  |  |
| Sauger, Wullstein                        | 368           |  |  |
| Sauger, Yankauer                         | 371-372       |  |  |
| Sauger, Zoellner                         | 368           |  |  |
| Saugeraufsatz, Coupland                  | 378           |  |  |
| Saugerhandgriff, Coupland                | 378           |  |  |
| Saugkanüle                               | 383           |  |  |
| Saugkanüle, Plester                      | 383           |  |  |
| Saugkürette, Novak                       | 627           |  |  |
| Saugraspatorium, Guilen                  | 720           |  |  |
| Saugrohr, Byrd                           | 378           |  |  |
| Saugrohr, Luer                           | 369           |  |  |
| Saugrohr, Yankauer                       | 372           |  |  |
| Saugrohr, Yasargil                       | 370           |  |  |
| Saugspitze, Yankauer                     | 372           |  |  |
| Saugventil, Cerullo                      | 370           |  |  |
| Scalp-Contour, Wundspreizer              | 282           |  |  |
| Scapulahaken, Davidson                   | 261           |  |  |
| Schädel, Tuchklemme                      | 211           |  |  |
| Schale                                   | 757           |  |  |
| Scharfe Nasenzange, Hartmann             | 693           |  |  |
| Scharfe Nasenzange, Struycken            | 691           |  |  |
| Scharfe Nasenzange, Weil                 | 689           |  |  |
| Scharfe Nasenzange, Weil-Blakesley       | 690           |  |  |
| Scharfer Doppellöffel                    | 486           |  |  |
| Scharfer Doppellöffel, Jacobson          | 486           |  |  |
| Scharfer Doppellöffel, Volkman           | 486           |  |  |
| Scharfer Doppellöffel, Williger          | 487           |  |  |
| Scharfer Löffel                          | 485           |  |  |
| Scharfer Löffel, Bruns                   | 483-484       |  |  |
| Scharfer Löffel, Daubenspeck             | 482           |  |  |
| Scharfer Löffel, Halle                   | 485           |  |  |
| Scharfer Löffel, Modell USA              | 485           |  |  |
| Scharfer Löffel, Schede                  | 482           |  |  |
| Scharfer Löffel, Scoville                | 484           |  |  |
| Scharfer Löffel, Simon                   | 484           |  |  |
| Scharfer Löffel, Spratt                  | 483           |  |  |
| Scharfer Löffel, Volkman                 | 481-482       |  |  |
| Schede, Scharfer Löffel                  | 482           |  |  |
| Scheibe, Organfasszange                  | 570           |  |  |
| Scheidenhalter, Doyen                    | 612           |  |  |
| Scheidenhalter, Kallmorgen               | 607           |  |  |
| Scheidenhalter, Kristeller               | 603-606       |  |  |
| Scherbak, Gewicht zum Vaginalspekulum    | 610           |  |  |
| Scherbak, Griff zum Vaginalspekulum      | 609, 610      |  |  |
| Scherbak, Spekulum-Blatt                 | 609           |  |  |
| Scherbak, Vaginalspekulum                | 610           |  |  |
| Schiebekloben, Martin-Rochard            | 323           |  |  |
| Schink, Dermatome                        | 14            |  |  |
| Schink, Ersatzklinge                     | 14            |  |  |
| Schink, Spannplatte                      | 14            |  |  |
| Schlauchklemme                           | 213-214       |  |  |
| Schlaucholive, Yankauer                  | 372           |  |  |
| Schlauchverbinder                        | 385           |  |  |
| Schleimhautmesser, Tabb                  | 659           |  |  |
| Schlinge, Brünings                       | 730           |  |  |
| Schlüssel f. Approximatoren              | 160           |  |  |
| Schmid, Gefäß-Spülkanüle                 | 384           |  |  |
| Schmieden, Führungshohlsonde             | 436           |  |  |
| Schmieden, Unterbindungsnaht             | 431           |  |  |
| Schmieden-Dick, Unterbindungsnaht        | 431           |  |  |
| Schmieden-Payr, Führungshohlsonde        | 436           |  |  |
| Schmieden-Taylor, Gefäßschere            | 77            |  |  |
| Schnidt, Präparierklemme                 | 177           |  |  |
| Schnidt, Tonsillenklemme                 | 729           |  |  |
| Schnürdraht                              | 670, 684, 730 |  |  |
| Schraube                                 | 508           |  |  |
| Schröder, Hakenzange                     | 619-620       |  |  |
| Schröder, Uteruslöffel                   | 633           |  |  |
| Schubert, Probeexzisionszange            | 628-629       |  |  |
| Schuhmacher, Nabelschnurschere           | 90            |  |  |
| Schuknecht, Sichelmesser                 | 659           |  |  |
| Schumacher, Aufsatz                      | 632           |  |  |
| Schumacher, Probeexzisionszange          | 632           |  |  |
| Schutzkappe, Rubin                       | 695           |  |  |
| Schwammzange, Bergmann                   | 222           |  |  |
| Schwammzange, Bozemann                   | 221           |  |  |
| Schwammzange, Föster                     | 222-223       |  |  |
| Schwammzange, Rampléy                    | 223           |  |  |
| Schweden-Modell, Anatomische Pinzette    | 128           |  |  |
| Schwenkkopf-Klingenthaler                | 6             |  |  |
| Schwenkschale                            | 758           |  |  |
| Schwesterngaritur                        | 744           |  |  |
| Schwingmesser, Ballenger                 | 700           |  |  |
| Scoville, Blattvalve                     | 321           |  |  |
| Scoville, Hakenvalve                     | 321           |  |  |
| Scoville, Laminektomiesperrer            | 320           |  |  |
| Scoville, Scharfer Löffel                | 484           |  |  |
| Scoville-Haverfield, Laminektomiesperrer | 320           |  |  |
| Scudder, Darmklemme                      | 575           |  |  |
| Sebileau, Elevatorium                    | 501           |  |  |
| Sedillot, Raspatorium                    | 490           |  |  |
| Segond, Myomesser                        | 624           |  |  |
| Sehndurchzuginstrument                   | 508           |  |  |
| Sehndurchzugsonde, Bunnell               | 508           |  |  |
| Sehndurchzugzange                        | 509           |  |  |
| Sehndurchzugzange, Brand                 | 509           |  |  |
| Sehneneinflecht-klemme                   | 510           |  |  |
| Sehnenfasszangchen                       | 510           |  |  |
| Sehnenfasszange, Carroll                 | 509           |  |  |
| Sehnenfasszange, Kleinert-Kutz           | 510           |  |  |
| Sehnenfasszange, Steinmann               | 509           |  |  |
| Sehnenstripper                           | 508           |  |  |
| Seiffert, Zangenaufsatz                  | 732           |  |  |
| Seitenvalve                              | 304-309       |  |  |
| Seitenvalve, Alan-Parks                  | 580           |  |  |
| Seitenvalve, Millin                      | 593           |  |  |
| Sellheim, Geburtslöffel                  | 640           |  |  |
| Semb, Hohlmeißelzange                    | 526           |  |  |
| Semb, Knochenhalte-zange                 | 515           |  |  |
| Semb, Raspatorium                        | 496           |  |  |
| Semken, Anatomische Pinzette             | 129           |  |  |
| Semken, Chirurgische Pinzette            | 131, 140      |  |  |
| Semm, Vaginalspekulum                    | 601           |  |  |
| Senn-Green, Wundhäkchen                  | 231           |  |  |
| Senn-Miller, Wundhäkchen                 | 231           |  |  |
| Septumlevatorium, Ballenger-Hajak        | 703           |  |  |
| Septumlevatorium, Cottle                 | 703-704       |  |  |
| Septumlevatorium, Freer                  | 701-702       |  |  |
| Septumlevatorium, Halle                  | 701           |  |  |
| Septumlevatorium, Howard                 | 703           |  |  |
| Septumlevatorium, Joseph                 | 701           |  |  |
| Septumlevatorium, Killian                | 703           |  |  |
| Septumlevatorium, McKenty                | 701-702       |  |  |
| Septumlevatorium, Pennington             | 704           |  |  |
| Septumlevatorium, Roger                  | 704           |  |  |
| Septum-Hohlmeißel, Ballenger             | 705           |  |  |
| Septum-Hohlmeißel, Freer                 | 705           |  |  |
| Septum-Hohlmeißel, Killian               | 705           |  |  |
| Septum-Hohlmeißel, Killian-Claus         | 705           |  |  |
| Septummeißel, Freer                      | 705           |  |  |
| Septumquetschzange                       | 694           |  |  |
| Septumquetschzange, Rubin                | 695           |  |  |

|   |         |  |          |  |               |
|---|---------|--|----------|--|---------------|
| Septumrichtzange, Asch .....                | 718     | Stimmgabel, Martin .....                     | 667      | Unterbindungsnadel, Brunner .....                    | 435           |
| Septumrichtzange, Cottle-Walsham .....      | 718     | Stimmgabel, Martin-Alloy .....               | 667      | Unterbindungsnadel, Cooper .....                     | 432           |
| Septumschere, Caplan .....                  | 694     | Stimmgabel, Neuro .....                      | 669      | Unterbindungsnadel, Deschamps .....                  | 433-434       |
| Septumzange .....                           | 670     | Stimmgabel, Rydel-Seiffert .....             | 669      | Unterbindungsnadel, Kronecker .....                  | 432           |
| Septumzange, Brünings .....                 | 687     | Stockmann, Penisklemme .....                 | 598      | Unterbindungsnadel, Schmieden .....                  | 431           |
| Septumzange, Kressner .....                 | 718     | Strabismusschere .....                       | 103      | Unterbindungsnadel, Schmieden-Dick .....             | 431           |
| Septumzange, Middleton-Jansen .....         | 694     | Strabismusschere, Westcott .....             | 103      | Uro-Tangential, Uro-Tangentialklemme .....           | 199           |
| Septumzangen .....                          | 687     | Strandell-Stille, Wundhäkchen .....          | 234      | Uro-Tangentialklemme, Uro-Tangential .....           | 199           |
| Septumzangen, Graig .....                   | 687     | Stratte, Nadelhalter .....                   | 413, 426 | Uterusdepressor, Braun .....                         | 618           |
| Septumzangen, Knight .....                  | 687     | Strauss, Paar Schläuche allein .....         | 598      | Uterusdilator, Hank .....                            | 617           |
| Shambaugh, Mikro-Ohrhäkchen .....           | 662     | Strauss, Penisklemme .....                   | 598      | Uterusdilator, Hegar .....                           | 614-616       |
| Shapleigh, Ohrkürette .....                 | 676     | Strully, Neurochirurgische Schere .....      | 77       | Uterusfasszange, Collin .....                        | 625           |
| Shea Vein Graft, Präparierschere .....      | 64      | Strümpel, Ohrpolypenzange .....              | 673      | Uterusfasszange, Dartigues .....                     | 625           |
| Shea, Sondierhaken .....                    | 662     | Struycken, Scharfe Nasenzange .....          | 691      | Uterusfasszange, Somer .....                         | 625           |
| Sichelmesser, Schuknecht .....              | 659     | <b>T</b>                                     |          | Uteruskürette, Blake .....                           | 633           |
| Sichelmesser, Wullstein .....               | 659     | Tabb, Schleimhautmesser .....                | 659      | Uteruskürette, Greene .....                          | 636           |
| Siebbeinzange .....                         | 689     | Takahashi, Siebbeinzange .....               | 688      | Uteruskürette, Recamier .....                        | 634           |
| Siebbeinzange, Takahashi .....              | 688     | Tamponstopfer, Luniatshchek .....            | 728      | Uteruskürette, Sims .....                            | 634           |
| Siebbeinzange, Watson-Williams .....        | 689     | Taylor, Anatomische Pinzette .....           | 129      | Uteruslöffel, Schröder .....                         | 633           |
| Siebbeinzange, Weil-Blakesley .....         | 690     | Taylor, Chirurgische Pinzette .....          | 141      | Uteruslöffel, Simon .....                            | 633           |
| Siegert, Feine Präparierschere .....        | 117     | Taylor, Spinalhaken .....                    | 507      | Uteruspolypenzange, Heywood-Smith .....              | 623           |
| Silikoneinlage .....                        | 753     | Teale, Hakenzange .....                      | 620      | Uteruspolypenzange, Kelly .....                      | 623           |
| Silver, Ersatzklinge .....                  | 14      | T-Griff, Nabatoff .....                      | 353      | Uteruspolypenzange, Noto .....                       | 623           |
| Silver, Handdermatom .....                  | 14      | Thoms-Allis, Darm- und Gewebefasszange ..... | 557      | Uterussonde, Sims .....                              | 618           |
| Silver, Nasenmeißel .....                   | 708     | Thoms-Gaylor, Probeexzisionszange .....      | 629      | Uterussonde, Valleix .....                           | 618           |
| Simon, Fistelhaken .....                    | 626     | Thorek, Präparierschere .....                | 50       | <b>V</b>   |               |
| Simon, Scharfer Löffel .....                | 484     | Thymushaken, Lukens .....                    | 549      | Vaginalspekulum, Auward .....                        | 611           |
| Simon, Uteruslöffel .....                   | 633     | Thyreoid- und Vulva-Spreizer, Joll .....     | 303      | Vaginalspekulum, Breisky .....                       | 612           |
| Simon, Wundhaken .....                      | 259     | Tieck-Halle, Nasenspekulum .....             | 681      | Vaginalspekulum, Collin .....                        | 600           |
| Simpson, Geburtszange .....                 | 638     | Toennis, Nadelhalter .....                   | 429      | Vaginalspekulum, Cusco .....                         | 600           |
| Sims, Gynäkologische Schere .....           | 30-31   | Toennis-Adson, Feine Präparierschere .....   | 78, 113  | Vaginalspekulum, Doyen .....                         | 608           |
| Sims, Mastdarm-Rektum-Spekulum .....        | 579     | Tohoku, Tuchklemme .....                     | 212      | Vaginalspekulum, Grave .....                         | 601           |
| Sims, Uteruskürette .....                   | 634     | Tonsillenelevator/Retraktor, Hurd .....      | 727      | Vaginalspekulum, Guttmann .....                      | 601           |
| Sims, Uterussonde .....                     | 618     | Tonsillenelevatorium, Henke .....            | 728      | Vaginalspekulum, Jackson .....                       | 602           |
| Sims, Vaginalspekulum .....                 | 602     | Tonsillenfasszange, White .....              | 729      | Vaginalspekulum, Kallmorgen .....                    | 607           |
| Sims-Siebold, Gynäkologische Schere .....   | 35      | Tonsillenkanüle .....                        | 382      | Vaginalspekulum, Kristeller .....                    | 603-606       |
| Singley-Tuttle, Fasspinzette .....          | 146     | Tonsillenklemme, Schindt .....               | 729      | Vaginalspekulum, Pederson .....                      | 601           |
| Sinusklemme, Lister .....                   | 219     | Tonsillennmesser, Brünings .....             | 727      | Vaginalspekulum, Scherbak .....                      | 610           |
| Skalpelloff, Collin .....                   | 5-8, 10 | Tonsillennmesser, Fisher .....               | 727      | Vaginalspekulum, Semm .....                          | 601           |
| Skalpelloff, Collin .....                   | 6       | Tonsillenschere, Dean .....                  | 80, 82   | Vaginalspekulum, Sims .....                          | 602           |
| Skalpelloff, Kaye .....                     | 8       | Tonsillenschere, Good .....                  | 81       | Vaginalspekulum, Weissbarth .....                    | 612           |
| Skalpelloff, Kaye .....                     | 9       | Tonsillenschnürer, Brünings .....            | 730      | Valleix, Uterussonde .....                           | 618           |
| Skene, Hakenzange .....                     | 620     | Tonsillenschnürer, Eves .....                | 730      | Valve, Cloward .....                                 | 296-297       |
| Smith-Petersen, Osteotom .....              | 469     | Tonsillenschnürer, Tyding .....              | 730      | Van Buren, Harnröhrenbougie .....                    | 594           |
| Somer, Uterusfasszange .....                | 625     | Tonsillenzange, Blohmke .....                | 729      | Van Doren, Probeexzisionszange .....                 | 630           |
| Sonde, Bowman .....                         | 645     | Tonsillenzange, Hartmann .....               | 731      | Varady, Mikrodissektor .....                         | 352           |
| Sondierhaken, Shea .....                    | 662     | Toynbee, Ohrspekulum .....                   | 664      | Varady, Mikro-Phlebextraktor .....                   | 352           |
| Spannplatte, Schink .....                   | 14      | Trachealdilatator, Laborde .....             | 548      | Varady, Mini-Phlebextraktor .....                    | 352           |
| Spannschlüssel .....                        | 462     | Trachealdilatator, Trousseau .....           | 548      | Varady, Phlebextraktor .....                         | 352           |
| Spekulum-Blatt, Scherbak .....              | 609     | Trachealhaken, Iterson .....                 | 549      | Varady, Phlebodissektor .....                        | 352           |
| Spencer, Fadenschere .....                  | 108     | Trachealhaken, Jackson .....                 | 549      | Varizenbesteck, Nabatoff .....                       | 353           |
| Spencer-Wells, Arterienklemme .....         | 167     | Trachealhaken, Luer .....                    | 549      | Veidenheimer, Rektum-Anastomosenklemme .....         | 577           |
| Sphinkteroskop, Kelly .....                 | 581     | Trachealhaken, Rose .....                    | 549      | Venenhäkchen, Brom .....                             | 234           |
| Spinalhaken, Taylor .....                   | 507     | Travers, Wundspreizer .....                  | 283      | Venenkanüle .....                                    | 381           |
| Splitterpinzette .....                      | 153-154 | Tröltsch (Wilde), Ohrpinzette .....          | 671      | Verbandschere .....                                  | 442           |
| Splitterpinzette, Feilchenfeld .....        | 154     | Tröltsch, Nasentamponpinzette .....          | 686      | Verbandschere, Lister .....                          | 442, 446      |
| Splitterpinzette, Hunter .....              | 154     | Trousseau, Trachealdilatator .....           | 548      | Verbandschere, Lorenz .....                          | 442           |
| Splitterzange, Peet .....                   | 156     | Troutman-Chris, Klingenthaler .....          | 4        | Verbandschere, Universal .....                       | 444           |
| Splitterzange, Stieglitz .....              | 156     | Tubenfasspinzette, Hepp-Scheidel .....       | 147      | Verbugge, Knochenhaltezange .....                    | 520-521       |
| Spongiosaentnahmemeißel, Lexer .....        | 463     | Tuchklemme .....                             | 213      | Verlängerungsrohr, Brünings .....                    | 632           |
| Spratt, Scharfer Löffel .....               | 483     | Tuchklemme, Backhaus .....                   | 211      | Virchow, Messer .....                                | 3             |
| Spülkanüle, Eicken-Killian .....            | 720     | Tuchklemme, Bernhard .....                   | 212      | Volkman, marTract .....                              | 344           |
| St. Marks, Beckenhaken .....                | 274     | Tuchklemme, Jones .....                      | 211      | Volkman, Scharfer Doppellöffel .....                 | 486           |
| St. Marks, marTract .....                   | 343     | Tuchklemme, Lane .....                       | 213      | Volkman, Scharfer Löffel .....                       | 481-482       |
| Stache, Knopfsonde .....                    | 350     | Tuchklemme, Lorna .....                      | 212      | Volkman, Wundhaken .....                             | 236-238       |
| Standgefäß .....                            | 759     | Tuchklemme, Peers-Bertram .....              | 213      | Vollmar, Ringstripper .....                          | 354           |
| Steinmann, Sehnenfasszange .....            | 509     | Tuchklemme, Peers-Bertram modif. .....       | 212      | <b>W</b>   |               |
| Stellbrink, Hohlmeißelzange .....           | 522     | Tuchklemme, Roeder .....                     | 212      | Wachenfeldt, Wundklammerpinzette .....               | 439           |
| Sterilisierklammer, Mayo .....              | 754     | Tuchklemme, Schädel .....                    | 211      | Wagener, Ohrhäkchen .....                            | 678           |
| Sterilisierzange .....                      | 750     | Tuchklemme, Tohoku .....                     | 212      | Wagner, Chirurgische Schere .....                    | 92            |
| Sterilisierzange, Cheattle .....            | 750     | Tuffier, Arterienklemme .....                | 168      | Waldmann, Episiotomieschere .....                    | 89            |
| Stevens, Irsschere .....                    | 101-102 | Tumorfasszange, Collin .....                 | 169      | Walter, Hohlmeißel .....                             | 707           |
| Stieglitz, Splitterzange .....              | 156     | Tunnelier-Kornzange .....                    | 220      | Walter, Osteotom .....                               | 707           |
| Stille, Chirurgische Pinzette .....         | 139     | Tuohy, Lumbalpunktionkanüle .....            | 382      | Wangensteen, Anatomische Pinzette .....              | 134           |
| Stille, Flachmeißel .....                   | 460     | Tupferzange, Cheron .....                    | 221      | Wangensteen, Nadelhalter .....                       | 413, 424      |
| Stille, Hohlmeißel .....                    | 461     | Tupferzange, Collin .....                    | 221      | Wasserstrahl-Reinigungspistole, Martin aquajet ..... | 762           |
| Stille, Hohlmeißelzange .....               | 526     | Tyding, Tonsillenschnürer .....              | 730      | Wassmund, Wundhaken .....                            | 241           |
| Stille, Osteotom .....                      | 460-461 | <b>U</b>                                     |          | Watson-Williams, Siebbeinzange .....                 | 689           |
| Stille-Barraya, Chirurgische Pinzette ..... | 145     | Überwurfmutter .....                         | 763      | Watteträger, Farrell .....                           | 355           |
| Stille-Liston, Knochensplitterzange .....   | 532-533 | Uhrmacher-Pinzette .....                     | 144      | Waugh, Anatomische Pinzette .....                    | 128           |
| Stille-Luer, Hohlmeißelzange .....          | 529     | Ulrich, Knochenhaltezange .....              | 517      | Waugh, Chirurgische Pinzette .....                   | 140           |
| Stille-Martin, Ersatzmesser .....           | 445     | Ulrich, Korn- u. Tupferzange .....           | 218      | Weber-Loch, Ohrschlinge .....                        | 677           |
| Stille-Martin, Gipsschere .....             | 445     | Universal, Drahtschere .....                 | 109      | Webster, Nadelhalter .....                           | 409, 415, 419 |
| Stille-Ruskin, Hohlmeißelzange .....        | 527     | Universal, Verbandschere .....               | 444      | Weil, Scharfe Nasenzange .....                       | 689           |
| Stimmgabel .....                            | 669     | Universal-Befestigungskloben, Martin .....   | 322, 323 | Weil-Blakesley, Scharfe Nasenzange .....             | 690           |
| Stimmgabel, French .....                    | 666     | Universalgriff, Huber .....                  | 632      | Weil-Blakesley, Siebbeinzange .....                  | 690           |
| Stimmgabel, Hartmann .....                  | 666-668 | Unterbindungsnadel .....                     | 432      | Weissbarth, Auffangsieb .....                        | 612           |
| Stimmgabel, König .....                     | 669     |  |          |  |               |
| Stimmgabel, Lucae .....                     | 668     |  |          |  |               |

# Index, alphabetisch

## Deutsch

|   |                    |   |              |
|---|--------------------|---|--------------|
| Weissbarth, Vaginalsekulum .....            | 612                | Wundspreizer, Finsen-Martin .....       | 280          |
| Weitlaner, Wundspreizer .....               | 284, 287-288       | Wundspreizer, Gelpi .....               | 303          |
| Weitlaner-Baby, Wundspreizer .....          | 292                | Wundspreizer, Henley .....              | 293          |
| Weitlaner-Wullstein, Wundspreizer .....     | 289                | Wundspreizer, Jansen .....              | 281          |
| Wertheim, Gynäkologische Schere .....       | 36                 | Wundspreizer, Low-Profile .....         | 302          |
| Wertheim, Hysterektomieklammer .....        | 208                | Wundspreizer, Martin .....              | 301          |
| Wertheim-Cullen, Hysterektomieklammer ..... | 205                | Wundspreizer, Milligan .....            | 292          |
| Westcott, Strabismusschere .....            | 103                | Wundspreizer, Mollison .....            | 289          |
| Westmacott, Nasentamponzange .....          | 686                | Wundspreizer, Norfolk-Norwich .....     | 283          |
| White, Tonsillenfasszange .....             | 729                | Wundspreizer, Plester .....             | 290          |
| Wikstroem, Präparierklammer .....           | 196                | Wundspreizer, Scalp-Contour .....       | 282          |
| Williams, Darm- und Gewebefasszange .....   | 558                | Wundspreizer, Travers .....             | 283          |
| Williams, Wundspreizer .....                | 291                | Wundspreizer, Weitlaner .....           | 284, 287-288 |
| Williger, Elevatorium .....                 | 501                | Wundspreizer, Weitlaner-Baby .....      | 292          |
| Williger, Hammer .....                      | 475, 477           | Wundspreizer, Weitlaner-Wullstein ..... | 289          |
| Williger, Raspatorium .....                 | 494                | Wundspreizer, Williams .....            | 291          |
| Williger, Scharfer Doppellöffel .....       | 487                | <b>Y</b>                                |              |
| Winkelschere, De Bakey .....                | 122                | Yankauer, Handgriff .....               | 372          |
| Winter, Abortuszange .....                  | 640                | Yankauer, Sauger .....                  | 371-372      |
| Wolff, Gipsabreisszange .....               | 449                | Yankauer, Saugrohr .....                | 372          |
| Wrigley, Geburtszange .....                 | 638                | Yankauer, Saugspitze .....              | 372          |
| Wullstein, Mikro-Ohrscherchen .....         | 655                | Yankauer, Schlaucholive .....           | 372          |
| Wullstein, Saugaufsatz .....                | 368                | Yasargil, Saugrohr .....                | 370          |
| Wullstein, Sauger .....                     | 368                | Young, Prostatahaken .....              | 589          |
| Wullstein, Sichelmesser .....               | 659                | <b>Z</b>                                |              |
| Wundhäkchen .....                           | 227-228, 230, 235  | Zahnfleischschere .....                 | 93-94        |
| Wundhäkchen, Cushing .....                  | 231                | Zahnfleischschere, Goldman-Fox .....    | 91           |
| Wundhäkchen, Langenbeck-Mini .....          | 229                | Zahnfleischschere, La Grange .....      | 93           |
| Wundhäkchen, Meyerding .....                | 230                | Zahnfleischschere, Locklin .....        | 94           |
| Wundhäkchen, Ragnell-Davis .....            | 231                | Zangenaufsatz, Brünings .....           | 732-733      |
| Wundhäkchen, Senn-Green .....               | 231                | Zangenaufsatz, Cordes .....             | 733          |
| Wundhäkchen, Senn-Miller .....              | 231                | Zangenaufsatz, Fraenkel .....           | 732          |
| Wundhäkchen, Strandell-Stille .....         | 234                | Zangenaufsatz, Krause .....             | 733          |
| Wundhaken .....                             | 238                | Zangenaufsatz, Lange .....              | 733          |
| Wundhaken, Brunner .....                    | 262-263            | Zangenaufsatz, Seiffert .....           | 732          |
| Wundhaken, Collin-Hartmann .....            | 276                | Zaufal, Fremdkörperheber .....          | 677          |
| Wundhaken, Coryllos .....                   | 260                | Zaufal-Jansen, Hohlmeißelzange .....    | 525          |
| Wundhaken, Deaver .....                     | 268-270            | Zenker, Präparierklammer .....          | 194          |
| Wundhaken, Doyen .....                      | 258                | Zenker, Wundhaken .....                 | 250          |
| Wundhaken, Doyen-Stille .....               | 254                | Zielke, Hohlmeißel .....                | 459          |
| Wundhaken, Farabeuf .....                   | 277                | Zoellner, Saugaufsatz .....             | 368          |
| Wundhaken, Fritsch .....                    | 257                | Zoellner, Sauger .....                  | 368          |
| Wundhaken, Goelet .....                     | 279                | Zugseil, Nabatoff .....                 | 353          |
| Wundhaken, Harrington .....                 | 267                | Zwischenstück .....                     | 385          |
| Wundhaken, Hösel .....                      | 255                |   |              |
| Wundhaken, Israel .....                     | 242                |   |              |
| Wundhaken, Kelly .....                      | 253, 273           |   |              |
| Wundhaken, Klapp .....                      | 235                |   |              |
| Wundhaken, Kocher .....                     | 239, 247, 251, 258 |   |              |
| Wundhaken, Kocher-Langenbeck .....          | 248-249            |   |              |
| Wundhaken, Körte .....                      | 241                |   |              |
| Wundhaken, Lahey .....                      | 246                |   |              |
| Wundhaken, Langenbeck .....                 | 243-245            |   |              |
| Wundhaken, Langenbeck-Green .....           | 245                |   |              |
| Wundhaken, Little .....                     | 246                |   |              |
| Wundhaken, Martin .....                     | 259                |   |              |
| Wundhaken, Martin-Rochard .....             | 323                |   |              |
| Wundhaken, Mathieu .....                    | 279                |   |              |
| Wundhaken, Middeldorpf .....                | 252, 256           |   |              |
| Wundhaken, Mikulic .....                    | 272                |   |              |
| Wundhaken, Ollier .....                     | 240                |   |              |
| Wundhaken, Parker .....                     | 278                |   |              |
| Wundhaken, Parker-Langenbeck .....          | 279                |   |              |
| Wundhaken, Parker-Mott .....                | 278                |   |              |
| Wundhaken, Richardson .....                 | 253                |   |              |
| Wundhaken, Richardson-Eastman .....         | 252                |   |              |
| Wundhaken, Roux .....                       | 276                |   |              |
| Wundhaken, Roux-Baby .....                  | 277                |   |              |
| Wundhaken, Roux-Mini .....                  | 277                |   |              |
| Wundhaken, Sauerbruch .....                 | 264                |   |              |
| Wundhaken, Simon .....                      | 259                |   |              |
| Wundhaken, Volkmann .....                   | 236-238            |   |              |
| Wundhaken, Wassmund .....                   | 241                |   |              |
| Wundhaken, Zenker .....                     | 250                |   |              |
| Wundklammerpinzette, Hegenbarth .....       | 439                |   |              |
| Wundklammerpinzette, Michel .....           | 439                |   |              |
| Wundklammerpinzette, Wachenfeldt .....      | 439                |   |              |
| Wundklammerzange, Michel .....              | 440                |   |              |
| Wundklammerzange, Richter .....             | 440                |   |              |
| Wundrandpinzette, Childe .....              | 439                |   |              |
| Wundspreizer .....                          | 280, 286-287, 302  |   |              |
| Wundspreizer, Adson .....                   | 285, 294-295, 298  |   |              |
| Wundspreizer, Alm .....                     | 281                |   |              |
| Wundspreizer, Anderson-Adson .....          | 282                |   |              |
| Wundspreizer, Beckman-Adson .....           | 299-300            |   |              |
| Wundspreizer, Beckmann .....                | 298                |   |              |
| Wundspreizer, Cloward .....                 | 296-297            |   |              |
| Wundspreizer, Finsen .....                  | 280                |   |              |

Index, alphabetical  
**English**



|  |                   |  |                    |
|--|-------------------|--|--------------------|
| <b>A</b>   |                   | <b>B</b>   |                    |
| Abdominal Retractor, Balfour .....                           | 312-313           | Babcock, Intestinal and Tissue Grasping<br>Forceps.....    | 558-559            |
| Abdominal Retractor, Balfour-Baby.....                       | 311               | Baby-Adson, Dissecting and Ligature Forceps.....           | 170                |
| Abdominal Retractor, Balfour-Standard .....                  | 314               | Baby-Poole, Suction Tube.....                              | 373                |
| Abdominal Retractor, Balfour, Mod. USA.....                  | 315               | Baby-Yankauer, Suction Tube .....                          | 371                |
| Abdominal Retractor, Collin .....                            | 304-306           | Backhaus, Towel Clamp.....                                 | 211                |
| Abdominal Retractor, Collin, Baby.....                       | 304, 307, 308     | Bakelit base .....   | 669                |
| Abdominal Retractor, Gosset .....                            | 310-311           | Bakes, Gall Duct Dilator.....                              | 585                |
| Abdominal Retractor, Gosset-Baby .....                       | 310               | Balfour-Baby, Abdominal Retractor .....                    | 311                |
| Abdominal Retractor, Kirschner.....                          | 317-318           | Balfour-Standard, Abdominal Retractor .....                | 314                |
| Abdominal Retractor, O'Sullivan-O'Connor.....                | 316               | Balfour-Standard, Central Blade.....                       | 312, 314-315       |
| Abdominal Retractor, Ricard.....                             | 307               | Balfour, Abdominal Retractor .....                         | 312-313            |
| Abdominal Spatula .....                                      | 348               | Balfour, Central Blade.....                                | 313                |
| Abdominal Spatula, Haberer.....                              | 348               | Balfour, Mod. USA, Abdominal Retractor.....                | 315                |
| Abdominal Spatula, Kader .....                               | 275               | Balfour, Mod. USA, Fenestrated Blade .....                 | 315                |
| Abdominal Spatula, Kümmel .....                              | 275               | Ballenger-Hajek, Septum Elevator .....                     | 703                |
| Abdominal Spatula, Martin .....                              | 348               | Ballenger, Septum Gouge .....                              | 705                |
| Adenoid Curette, Beckmann.....                               | 720               | Ballenger, Swivel Knife .....                              | 700                |
| Adlerkreutz, Dissecting Forceps.....                         | 139               | Bandage Scissors.....                                      | 442                |
| Adson-Baby, Dissecting and<br>Ligature Forceps.....          | 186               | Bandage Scissors, Lister .....                             | 442, 446           |
| Adson-Brown, Dissecting Forceps.....                         | 132, 142          | Bandage Scissors, Lorenz.....                              | 442                |
| Adson, Dissecting and Ligature Forceps.....                  | 177               | Bandage Scissors, Universal .....                          | 444                |
| Adson, Dissecting Forceps.....                               | 132, 140          | Barbara, Micro Ear Hook .....                              | 660                |
| Adson, Dressing Forceps.....                                 | 128, 132          | Barbara, Micro Ear Needle .....                            | 660-661            |
| Adson, Elevator .....  | 498               | Baron-Schuknecht, Suction Tube .....                       | 369                |
| Adson, Needle Holder .....                                   | 410               | Barraquer-Troutman, Micro Needle Holder .....              | 406                |
| Adson, Suction Tube.....                                     | 364               | Barraquer, Cilia Forceps .....                             | 155                |
| Adson, Wound Spreaders,<br>self-retaining .....              | 285, 294-295, 298 | Barraquer, Micro Needle Holder .....                       | 406-407, 419       |
| Alan-Parks, Central Blade .....                              | 580               | Battery Handle .....                                       | 393                |
| Alan-Parks, Lateral Blade .....                              | 580               | Battery Handle .....                                       | 394, 396, 398, 400 |
| Alan-Parks, marTract .....                                   | 338               | Beacham, Amniotome .....                                   | 619                |
| Alan-Parks, Rectal Spreader .....                            | 580               | Beckman-Adson, Wound Spreaders,<br>self-retaining .....    | 299-300            |
| Alan-Parks, Wing nut .....                                   | 580               | Beckmann, Adenoid Curette .....                            | 720                |
| Alar Hooklet, Converse .....                                 | 716               | Beckmann, Wound Spreaders, self-retaining.....             | 298                |
| Alar Hooklet, Cottle .....                                   | 717               | Beebee, Wire Cutting Scissors .....                        | 110                |
| Alar Hooklet, Cottle-Neivert .....                           | 717               | Beer, Cilia Forceps.....                                   | 155                |
| Alar Hooklet, Fomon.....                                     | 715-716           | Bellucci, Micro Ear Scissors.....                          | 654                |
| Alar Hooklet, Kilner .....                                   | 716               | Bengolea, Haemostatic Forceps .....                        | 180                |
| Alar Hooklet, Lange .....                                    | 715               | Bennett, Bone Lever .....                                  | 506                |
| Alar Hooklet, Neivert .....                                  | 717               | Benson, Pylorus Spreader.....                              | 567                |
| Alderdyce, Dissector, double-ended .....                     | 501               | Bergmann, Plaster Shears .....                             | 443                |
| Alexander, Chisel.....                                       | 459               | Bergmann, Sponge Forceps.....                              | 222                |
| Alexander, Gouge.....  | 459               | Bernhard, Towel Clamp.....                                 | 212                |
| Alexander, Periosteal Elevator.....                          | 496               | Beyer, Bone Rongeur.....                                   | 525                |
| Alexander, Uterine Biopsy Forceps.....                       | 631               | Beyer, Mastoid Rongeur.....                                | 675                |
| Allen, Intestinal Clamp.....                                 | 564               | Biemer-Müller, Approximator.....                           | 159                |
| Allis-Adair, Intestinal and Tissue Grasping<br>Forceps ..... | 557               | Biemer, Micro Scissors .....                               | 105                |
| Allis-Baby, Intestinal and Tissue Grasping<br>Forceps .....  | 556               | Biemer, Vessel Clip .....                                  | 158                |
| Allis, Intestinal and Tissue Grasping<br>Forceps.....        | 556-557           | Bile Duct Clamp, Desjardins .....                          | 201                |
| Alm, Wound Spreaders, self-retaining .....                   | 281               | Bile Duct Clamp, Lahey .....                               | 198                |
| Alveotomy File, Miller .....                                 | 499               | Billeau, Ear Loop .....                                    | 677                |
| Amniotome, Beacham.....                                      | 619               | Bircher-Ganske, Cartilage Seizing Forceps .....            | 511                |
| Amputation Knife, Liston .....                               | 13                | Bladder Neck Spreader, Millin .....                        | 592                |
| Amputation Retractor, Percy.....                             | 521               | Bladder Retractor, Judd-Masson.....                        | 592                |
| Anderson-Adson, Wound Spreaders,<br>self-retaining .....     | 282               | Bladder Retractor, Millin .....                            | 593                |
| Angled Scissors, De Bakey.....                               | 122               | Blade Holder / Blade Breaker.....                          | 4                  |
| Antrum Curette, Coakley.....                                 | 719               | Blade Holder / Blade Breaker, Castroviejo .....            | 4                  |
| Antrum Irrigation Cannula, Eicken-Killian .....              | 720               | Blade Holder / Blade Breaker, Troutman-Chris .....         | 4                  |
| Antrum Punch.....  | 692               | Blade, Kirschner .....                                     | 317-319            |
| Antrum Punch, Kerrison .....                                 | 698               | Blade, Scoville.....                                       | 321                |
| Anuscope, Ives-Fansler.....                                  | 579               | Blades, (pair), Cloward .....                              | 296-297            |
| Aorta Retractor, Borowski.....                               | 266               | Blake, Gall Stone Forceps.....                             | 586                |
| Aorta Retractor, Ross.....                                   | 265               | Blake, Uterine Scoop.....                                  | 633                |
| Approximation Forceps, Childe .....                          | 439               | Blohmke, Tonsil Grasping Forceps .....                     | 729                |
| Approximator .....   | 160               | Blount, Knee Retractor .....                               | 507                |
| Approximator, Biemer-Müller.....                             | 159               | Blount, Knee Retractor .....                               | 507                |
| Asch, Septum Straightening Forceps .....                     | 718               | Blumenthal, Bone Rongeur.....                              | 524                |
| Aston, Face-lift Scissors.....                               | 45                | Böhler, Bone Cutting Forceps .....                         | 531                |
| Atraumatic Dressing Forceps.....                             | 130               | Böhler, Bone Rongeur.....                                  | 525                |
| Atraumatic Dressing Forceps, DeBakey.....                    | 135-136           | Bone Chisel.....   | 456                |
| Atraumatic Dressing Forceps, Gerald .....                    | 136               | Bone Curette.....  | 485                |
| Atraumatic Micro Forceps.....                                | 151               | Bone Curette, Bruns .....                                  | 483-484            |
| Atrium Retractor, Cooley.....                                | 271               | Bone Curette, Daubenspeck.....                             | 482                |
| Attic Dissector, Austin .....                                | 662               | Bone Curette, double-ended.....                            | 486                |
| Aufricht, Glabella Rasp .....                                | 712               | Bone Curette, double-ended, Jacobson .....                 | 486                |
| Aufricht, Nasal Retractor .....                              | 715, 717          | Bone Curette, double-ended, Molt .....                     | 487                |
| Austin, Attic Dissector .....                                | 662               | Bone Curette, double-ended, Volkmann.....                  | 486                |
| Auvar, Vaginal Speculum .....                                | 611               | Bone Curette, double-ended, Williger.....                  | 487                |
| Auvar, Weight for Vaginal Speculum.....                      | 611               | Bone Curette, Halle .....                                  | 485                |
|  |                   | Bone Curette, Modell USA .....                             | 485                |
|  |                   | Bone Curette, Schede .....                                 | 482                |
|  |                   | Bone Curette, Scoville .....                               | 484                |
|  |                   | Bone Curette, Simon .....                                  | 484                |
|  |                   | Bone Curette, Spratt .....                                 | 483                |
|  |                   | Bone Curette, Volkmann.....                                | 481-482            |
|  |                   | Bone Cutting Forceps, Böhler .....                         | 531                |
|  |                   | Bone Cutting Forceps, Cleveland .....                      | 531                |
|  |                   | Bone Cutting Forceps, Cottle-Kazanjan .....                | 530                |
|  |                   | Bone Cutting Forceps, Liston .....                         | 530                |
|  |                   | Bone Cutting Forceps, Liston-Key .....                     | 534                |
|  |                   | Bone Cutting Forceps, Ruskin-Liston .....                  | 532                |
|  |                   | Bone Cutting Forceps, Stille-Liston .....                  | 532-533            |
|  |                   | Bone File.....   | 497                |
|  |                   | Bone File, Joseph .....                                    | 711                |
|  |                   | Bone File, Miller-Colburn.....                             | 498-499            |
|  |                   | Bone Holding Forceps .....                                 | 514                |
|  |                   | Bone Holding Forceps .....                                 | 511, 518           |
|  |                   | Bone Holding Forceps .....                                 | 512                |
|  |                   | Bone Holding Forceps, Farabeuf.....                        | 516                |
|  |                   | Bone Holding Forceps, Fergusson.....                       | 513                |
|  |                   | Bone Holding Forceps, Frosch .....                         | 513                |
|  |                   | Bone Holding Forceps, Kern .....                           | 515                |
|  |                   | Bone Holding Forceps, Lane .....                           | 519                |
|  |                   | Bone Holding Forceps, Langenbeck.....                      | 513                |
|  |                   | Bone Holding Forceps, Lewin.....                           | 512                |
|  |                   | Bone Holding Forceps, Semb.....                            | 515                |
|  |                   | Bone Holding Forceps, Ulrich .....                         | 517                |
|  |                   | Bone Holding Forceps, Verbrugge.....                       | 520-521            |
|  |                   | Bone Hooklet, Rasse .....                                  | 226                |
|  |                   | Bone Lever.....  | 502                |
|  |                   | Bone Lever, Bennett.....                                   | 506                |
|  |                   | Bone Lever, Hohmann.....                                   | 503-505            |
|  |                   | Bone Lever, Hohmann, mini.....                             | 502                |
|  |                   | Bone Lever, Lange-Hohmann .....                            | 505                |
|  |                   | Bone Rasp, Putti .....                                     | 473                |
|  |                   | Bone Rongeur.....  | 524                |
|  |                   | Bone Rongeur, Beyer.....                                   | 525                |
|  |                   | Bone Rongeur, Blumenthal.....                              | 524                |
|  |                   | Bone Rongeur, Böhler.....                                  | 525                |
|  |                   | Bone Rongeur, Cleveland.....                               | 522                |
|  |                   | Bone Rongeur, Echlin .....                                 | 527                |
|  |                   | Bone Rongeur, Friedmann .....                              | 522                |
|  |                   | Bone Rongeur, Frykholm .....                               | 528                |
|  |                   | Bone Rongeur, Hartmann .....                               | 523                |
|  |                   | Bone Rongeur, Jansen.....                                  | 523                |
|  |                   | Bone Rongeur, Leksell-Stille .....                         | 528                |
|  |                   | Bone Rongeur, Lempert .....                                | 523                |
|  |                   | Bone Rongeur, Luer.....                                    | 525                |
|  |                   | Bone Rongeur, Marquard.....                                | 526                |
|  |                   | Bone Rongeur, Mayfield.....                                | 526                |
|  |                   | Bone Rongeur, Mead.....                                    | 523                |
|  |                   | Bone Rongeur, Ruskin .....                                 | 526                |
|  |                   | Bone Rongeur, Semb.....                                    | 526                |
|  |                   | Bone Rongeur, Stille-Ruskin .....                          | 522                |
|  |                   | Bone Rongeur, Stille.....                                  | 526                |
|  |                   | Bone Rongeur, Stille-Luer .....                            | 529                |
|  |                   | Bone Rongeur, Stille-Ruskin .....                          | 527                |
|  |                   | Bone Rongeur, Zaufal-Jansen .....                          | 525                |
|  |                   | Bonney, Dissecting Forceps .....                           | 131, 146           |
|  |                   | Bonney, Dressing Forceps .....                             | 127                |
|  |                   | Borowski, Aorta Retractor .....                            | 266                |
|  |                   | Bowman, Probe .....  | 645                |
|  |                   | Boys-Allis, Intestinal and Tissue Grasping<br>Forceps..... | 557                |
|  |                   | Bozemann, Needle Holder.....                               | 425                |
|  |                   | Bozemann, Sponge Forceps .....                             | 221                |
|  |                   | Brand, Tendon Tunneling Forceps .....                      | 509                |
|  |                   | Braun-Stadler, Episiotomy Scissors.....                    | 89                 |
|  |                   | Braun, Uterine Depressor .....                             | 618                |
|  |                   | Braun, Uterine Tenaculum Forceps.....                      | 619, 622           |
|  |                   | Breisky, marTract .....                                    | 340                |
|  |                   | Breisky, Vaginal Speculum.....                             | 612                |
|  |                   | Brom, Vein Hook .....                                      | 234                |
|  |                   | Brompton, Tube milking roller .....                        | 215                |
|  |                   | Brown, Needle Holder .....                                 | 410                |
|  |                   | Brünings, Exchangeable Tip.....                            | 732-733            |
|  |                   | Brünings, Interchangeable Tube .....                       | 632                |
|  |                   | Brünings, Laryngeal Tube .....                             | 732                |
|  |                   | Brünings, Septum Forceps .....                             | 687                |
|  |                   | Brünings, Tonsil Knife .....                               | 727                |
|  |                   | Brünings, Tonsil Snare .....                               | 730                |
|  |                   | Brünings, Wire Loop .....                                  | 730                |
|  |                   | Brunner, Ligature Conductor .....                          | 435                |
|  |                   | Brunner, Ligature Needle.....                              | 435                |
|  |                   | Brunner, Retractor .....                                   | 262-263            |
|  |                   | Brunner, Sigmoid Anastomosis Forceps .....                 | 575                |
|  |                   | Bruns, Bone Curette .....                                  | 483-484            |
|  |                   | Bruns, Plaster Scissors .....                              | 444, 446           |
|  |                   | Brush Dispenser, Martin.....                               | 742-743            |
|  |                   | Bryant, Dressing Forceps .....                             | 219                |
|  |                   | Buck, Ear Curette .....                                    | 676                |
|  |                   | Buck, Foreign Body Lever .....                             | 672                |
|  |                   | Buck, Stitch Scissors .....                                | 108                |
|  |                   | Bulldog Clamp.....   | 162                |



Bulldog Clamp, DeBakey-Diethrich .....164  
 Bulldog Clamp, Dieffenbach .....162  
 Bulldog Clamp, Diethrich .....164  
 Bulldog Clamp, Johns-Hopkins .....163  
 Bulldog Clamp, Mini-Glover .....165-166  
 Bunnell, Tendon Passer .....508  
 Busch, Umbilical Scissors .....90  
 Byrd, Suction Tube .....378

**C**

Caliper, Castroviejo .....644  
 Caliper, Castroviejo-Epker .....644  
 Cannula .....381  
 Caplan, Septum Forceps .....694  
 Capsule Forceps, Millin .....590-591  
 Carroll, Tendon Holding Forceps .....509  
 Cartilage Crusher, Cottle .....710  
 Cartilage Seizing Forceps, Bircher-Ganske .....511  
 Cartilage Seizing Forceps, Dingmann .....511  
 Cartilage Seizing Forceps, Martin .....512  
 Case for Laryngoscopes .....393  
 Caspar, Tamper .....474  
 Castroviejo-Epker, Caliper .....644  
 Castroviejo-Fino, Micro Needle Holder .....407  
 Castroviejo, Blade Holder / Blade Breaker .....4  
 Castroviejo, Caliper .....644  
 Castroviejo, Micro Needle Holder .....408, 418-419  
 Catheter Fitting .....385  
 Catheter insertion instrument, Dittel .....388  
 Catheter Introducing Forceps, Magill .....388  
 Central Blade, Alan-Parks .....580  
 Central Blade, Balfour .....313  
 Central Blade, Balfour-Standard .....312, 314-315  
 Central Blade, Collin .....305-306  
 Central Blade, Gosset .....310  
 Central Blade, Henley .....293  
 Central Blade, Low-Profile .....302  
 Central Blade, Millin .....593  
 Central Blade, O'Sullivan-O'Connor .....316  
 Central Blade, Ricard .....307  
 Cerullo, Suction valve .....370  
 Chaput, Haemostatic Forceps .....168  
 Cheattle, Sterilizing Forceps .....750  
 Cheron, Dressing Forceps .....221  
 Child, Approximation Forceps .....439  
 Chisel .....457  
 Chisel Blade .....462  
 Chisel Handle .....462  
 Chisel, Alexander .....459  
 Chisel, Fomon .....707  
 Chisel, Hibbs .....471  
 Chisel, Partsch .....458  
 Chisel, Stille .....460  
 Cilia Forceps .....155  
 Cilia Forceps, Barraquer .....155  
 Cilia Forceps, Beer .....155  
 Cilia Forceps, Douglas .....155  
 Cilia Forceps, Littauer .....155  
 Cinelli, Nasal Scissors .....50  
 Cinelli, Osteotome .....708  
 Circular Cut Knife, Rosen .....659  
 Circumcision Instrument .....596  
 Circumcision Instrument, Mogen .....596  
 Citelli, Mastoid Rongeur .....674  
 Clamp Holder, De Martel-Wolfson .....567  
 Cleaning Brush .....767  
 Cleaning Brush .....767  
 Cleaning Brush .....767  
 Cleaning Brush .....764-767  
 Cleansing Tip, Martin aquajet .....762-763  
 Cleft Palate Dissector, Salyer .....726  
 Cleft Palate Elevator, Salyer .....726  
 Cleft Palate Hooklet, Salyer .....726  
 Cleft Palate Periosteal Rasapatory, Krenkel .....701  
 Cleveland, Bone Cutting Forceps .....531  
 Cleveland, Bone Rongeur .....522  
 Clip Applying Forceps .....158  
 Clip Applying Forceps .....161  
 Clip Applying Forceps, Hegenbarth .....439  
 Clip Applying Forceps, Michel .....439  
 Clip Applying Forceps, Michel .....440  
 Clip Applying Forceps, Mini-Glover .....166  
 Clip Applying Forceps, Richter .....440  
 Clip Applying Forceps, Wachenfeldt .....439  
 Closing Forceps, De Martel-Wolfson .....566  
 Cloward, Blades, (pair) .....296-297  
 Cloward, Wound Spreaders, self-retaining .....296-297  
 Coakley, Antrum Curette .....719  
 Cobb, Gouge .....470

Cobb, Periosteal Elevator .....492  
 Cogswell, Suction Tube .....378  
 Collier, Needle Holder .....409  
 Collin-Hartmann, Retractor .....276  
 Collin, Abdominal Retractor .....304-306  
 Collin, Baby, Abdominal Retractor .....304, 307-308  
 Collin, Central Blade .....305-306  
 Collin, Dressing Forceps .....221  
 Collin, Mallet .....476  
 Collin, Organ Grasping Forceps .....169  
 Collin, Scalpel Handle .....6  
 Collin, Tumor Grasping Forceps .....169  
 Collin, Umbilical Cord Clamp .....642  
 Collin, Uterine Seizing Forceps .....625  
 Collin, Vaginal Speculum .....600  
 Columella Forceps, Cottle .....719  
 Connector .....385  
 Connector .....385  
 Converse, Alar Hooklet .....716  
 Converse, Nasal Retractor .....716  
 Converse, Nasal Scissors .....88  
 Converse, Rhinoplastic Knife .....699  
 Cooley, Atrium Retractor .....271  
 Cooley, Suction Tube .....375  
 Cooper, Ligature Needle .....432  
 Cordes, Exchangeable Tip .....733  
 Coronary Scissors, Dietrich-Potts .....73  
 Coryllos, Retractor .....260  
 Cottle-Kazanjan, Bone Cutting Forceps .....530  
 Cottle-Neivert, Alar Hooklet .....717  
 Cottle-Walsham, Septum Straightening Forceps .....718  
 Cottle, Alar Hooklet .....717  
 Cottle, Cartilage Crusher .....710  
 Cottle, Columella Forceps .....719  
 Cottle, Mallet .....476  
 Cottle, Nasal Hook .....715  
 Cottle, Nasal Rasp .....711  
 Cottle, Nasal Retractor .....717  
 Cottle, Nasal Scissors .....85  
 Cottle, Nasal Speculum .....682-683  
 Cottle, Osteotome .....706  
 Cottle, Periosteal Elevator .....704  
 Cottle, Periosteal Elevator .....490  
 Cottle, Rhinoplastic Knife .....699  
 Cottle, Saddle Hook .....717  
 Cottle, Septum Elevator .....703-704  
 Cottle, Skin Grasping Forceps .....719  
 Cotton Applicator, Farrell .....355  
 Coupland, Suction Handle .....378  
 Coupland, Suction Tip .....378  
 Coupling .....763  
 Coupling Piece .....636  
 Crafoord, Dissecting and Ligature Forceps .....188  
 Crile-Murray, Needle Holder .....410  
 Crile-Rankin, Haemostatic Forceps .....176  
 Crile-Wood, Needle Holder .....410, 415, 420  
 Crile, Haemostatic Forceps .....175  
 Crile, Needle Holder .....414  
 Cross Bar, Martin-Rochard .....323  
 Curette double ended, Faulkner .....719  
 Cusco, Vaginal Speculum .....600  
 Cushing-Taylor, Dressing Forceps .....133  
 Cushing, Dressing Forceps .....130, 133, 142  
 Cushing, Retractor .....231  
 Cushing, Saddle Hook .....232  
 Cuticle Nipper .....745  
 Cuticle Scissors .....745  
 Cuzzi, Placenta Scoop .....641  
 Czerny, Rectal Speculum .....579  
 Czerny, Uterine Tenaculum Forceps .....622

**D**

Damper, Rydel-Seiffert .....669  
 Dandy-Mosquito, Haemostatic Forceps .....176  
 Dandy, Haemostatic Forceps .....176  
 Dartigues, Uterine Seizing Forceps .....625  
 Daubenspeck, Bone Curette .....482  
 Davidson, Scapula Retractor .....261  
 Day, Ear Hooklet .....678  
 De Martel-Wolfson, Clamp Holder .....567  
 De Martel-Wolfson, Closing Forceps .....566  
 De Martel-Wolfson, Intestinal Anastomosis Clamp .....566  
 Dean, Tonsil Scissors .....80, 82  
 Deaver, marTract .....337  
 Deaver, Operating Scissors .....23  
 Deaver, Retractor .....268-270  
 DeBakey-Adson, Suction Tube .....371  
 DeBakey-Diethrich, Bulldog Clamp .....164

DeBakey, Angled Scissors .....122  
 DeBakey, Atraumatic Dressing Forceps .....135-136  
 DeBakey, Dissecting Scissors .....49  
 DeBakey, Needle Holder .....422  
 DeBakey, Vascular Scissors .....72  
 Delicate Dissecting Scissors, Lexer-Fino .....52  
 Delicate Dissecting Scissors, Metzenbaum-Fino .....53-58, 113, 117  
 Delicate Dissecting Scissors, Metzenbaum-Lahey .....117  
 Delicate Dissecting Scissors, Siegert .....117  
 Delicate Dissecting Scissors, Toennis-Adson .....78, 113  
 Derf, Needle Holder .....409, 419  
 Dermatome, Humby .....14  
 Dermatome, Schink .....14  
 Dermatome, Silver .....14  
 Deschamps, Ligature Needle .....433-434  
 Desjardins, Bile Duct Clamp .....201  
 Desjardins, Gall Stone Forceps .....587  
 Desmarres, Saddle Hook .....229  
 Dieffenbach, Bulldog Clamp .....162  
 Diethrich-Salyer, Dissecting Scissors .....72  
 Diethrich, Bulldog Clamp .....164  
 Diethrich, Vascular Scissors .....72  
 Dietrich-Hegemann, Vascular Scissors .....74  
 Dietrich-Potts, Coronary Scissors .....73  
 Dietrich-Potts, Vascular Scissors .....73  
 Dingmann, Cartilage Seizing Forceps .....511  
 Disposable Scalpel .....11-12  
 Dissecting and Ligature Forceps, Adson .....177  
 Dissecting and Ligature Forceps, Adson-Baby .....186  
 Dissecting and Ligature Forceps, Baby-Adson .....170  
 Dissecting and Ligature Forceps, Crafoord .....188  
 Dissecting and Ligature Forceps, Finochietto .....198  
 Dissecting and Ligature Forceps, Gemini .....192  
 Dissecting and Ligature Forceps, Heiss .....186  
 Dissecting and Ligature Forceps, Kelly .....202  
 Dissecting and Ligature Forceps, Lawrence .....203  
 Dissecting and Ligature Forceps, Lower .....198  
 Dissecting and Ligature Forceps, Martin-Fuchsig .....177  
 Dissecting and Ligature Forceps, McQuigg-Mixer .....197  
 Dissecting and Ligature Forceps, Meeker .....203  
 Dissecting and Ligature Forceps, Mikro-Adson .....170  
 Dissecting and Ligature Forceps, Mini-Gemini .....192  
 Dissecting and Ligature Forceps, Mixer .....195-197  
 Dissecting and Ligature Forceps, Mixer-Baby .....170, 186, 194  
 Dissecting and Ligature Forceps, O'Shaughnessy .....195  
 Dissecting and Ligature Forceps, Overholt .....191  
 Dissecting and Ligature Forceps, Overholt-Baby .....175  
 Dissecting and Ligature Forceps, Overholt-Fino .....190  
 Dissecting and Ligature Forceps, Overholt-Geissendörfer .....189  
 Dissecting and Ligature Forceps, Overholt-Martin .....185  
 Dissecting and Ligature Forceps, Overholt-Mini .....191  
 Dissecting and Ligature Forceps, Overholt-Mixer .....186  
 Dissecting and Ligature Forceps, Roberts .....187  
 Dissecting and Ligature Forceps, Rumel .....193  
 Dissecting and Ligature Forceps, Sarot .....187  
 Dissecting and Ligature Forceps, Schnid .....177  
 Dissecting and Ligature Forceps, Wikstroem .....196  
 Dissecting and Ligature Forceps, Zenker .....194  
 Dissecting Forceps .....137-139, 143, 148  
 Dissecting Forceps, Adlerkreutz .....139  
 Dissecting Forceps, Adson .....132, 140  
 Dissecting Forceps, Adson-Brown .....132, 142  
 Dissecting Forceps, Bonney .....131, 146  
 Dissecting Forceps, Cushing .....142  
 Dissecting Forceps, Durante .....145  
 Dissecting Forceps, Gerald .....131, 142  
 Dissecting Forceps, Gillies .....131, 140  
 Dissecting Forceps, Jaboma .....135  
 Dissecting Forceps, Mayo .....146  
 Dissecting Forceps, Mikro-Adson .....143  
 Dissecting Forceps, Mini-Adson .....143  
 Dissecting Forceps, Nelson .....147  
 Dissecting Forceps, Oehler .....134  
 Dissecting Forceps, Potts-Smith .....142  
 Dissecting Forceps, Resano .....147  
 Dissecting Forceps, Russ, Modell .....145  
 Dissecting Forceps, Semken .....131, 140  
 Dissecting Forceps, Singley-Tuttle .....146  
 Dissecting Forceps, Stille .....139  
 Dissecting Forceps, Stille-Barraya .....145  
 Dissecting Forceps, Taylor .....141

|   |                |
|---|----------------|
| Dissecting Forceps, Waugh                         | 140            |
| Dissecting Knife                                  | 2              |
| Dissecting Scissors                               | 44, 59, 64     |
| Dissecting Scissors, DeBaKey                      | 49             |
| Dissecting Scissors, Diethrich-Salyer             | 72             |
| Dissecting Scissors, Hohenfellner                 | 49             |
| Dissecting Scissors, Jameson                      | 69             |
| Dissecting Scissors, Kilner                       | 65             |
| Dissecting Scissors, Knapp                        | 114            |
| Dissecting Scissors, Kübler                       | 44             |
| Dissecting Scissors, Lexer                        | 46-48, 51, 115 |
| Dissecting Scissors, Lexer-Baby                   | 51             |
| Dissecting Scissors, Mayo-Harrington              | 29             |
| Dissecting Scissors, Mayo-Lexer                   | 116            |
| Dissecting Scissors, Mayo-Noble                   | 29             |
| Dissecting Scissors, Mayo-Stille                  | 26-28          |
| Dissecting Scissors, Metzenbaum                   | 37-44          |
| Dissecting Scissors, Metzenbaum-Nelson            | 40             |
| Dissecting Scissors, Metzenbaum-Thorek            | 115            |
| Dissecting Scissors, Olivecrona                   | 79             |
| Dissecting Scissors, Ragnell                      | 123            |
| Dissecting Scissors, Reynolds                     | 67-68          |
| Dissecting Scissors, Salyer                       | 59, 107        |
| Dissecting Scissors, Shea Vein Graft              | 64             |
| Dissecting Scissors, Thorek                       | 50             |
| Dissector, double-ended                           | 501            |
| Dissector, double-ended, Alderdyce                | 501            |
| Dissector, double-ended, McDonald                 | 501            |
| Dittel, Catheter insertion instrument             | 388            |
| Douglas, Cilia Forceps                            | 155            |
| Doyen-Baby, Intestinal Clamp                      | 561, 571       |
| Doyen-Stille, Retractor                           | 254            |
| Doyen, Grooved Director                           | 351            |
| Doyen, Gynecological Scissors                     | 34             |
| Doyen, Intestinal Clamp                           | 560            |
| Doyen, Mallet                                     | 475            |
| Doyen, Myoma Screw                                | 624            |
| Doyen, Retractor                                  | 258            |
| Doyen, Rib Raspatory                              | 495            |
| Doyen, Vaginal Retractor                          | 612            |
| Doyen, Vaginal Speculum                           | 608            |
| Dressing Forceps                                  | 126-127, 148   |
| Dressing Forceps in jar, with cap,<br>Mod. Martin | 754            |
| Dressing Forceps, Adson                           | 128, 132       |
| Dressing Forceps, Bonney                          | 127            |
| Dressing Forceps, Bryant                          | 219            |
| Dressing Forceps, Cheron                          | 221            |
| Dressing Forceps, Collin                          | 221            |
| Dressing Forceps, Cushing                         | 130, 133       |
| Dressing Forceps, Cushing-Taylor                  | 133            |
| Dressing Forceps, Gerald                          | 130            |
| Dressing Forceps, Gross-Maier                     | 220            |
| Dressing Forceps, Jaboma                          | 135            |
| Dressing Forceps, Kübler                          | 134            |
| Dressing Forceps, Martin                          | 219            |
| Dressing Forceps, McIndoe                         | 128, 131       |
| Dressing Forceps, Mikro-Adson                     | 143            |
| Dressing Forceps, Mikro-Adson, Shigeno            | 143            |
| Dressing Forceps, Mini-Adson                      | 128            |
| Dressing Forceps, Potts-Smith                     | 130, 133       |
| Dressing Forceps, Schweden-Modell                 | 128            |
| Dressing Forceps, Semken                          | 129            |
| Dressing Forceps, Taylor                          | 129            |
| Dressing Forceps, Ulrich                          | 218            |
| Dressing Forceps, Wangenstein                     | 134            |
| Dressing Forceps, Waugh                           | 128            |
| Dunhill, Haemostatic Forceps                      | 174            |
| Duplay, Uterine Tenaculum Forceps                 | 619            |
| Durante, Dissecting Forceps                       | 145            |
| Duval, Intestinal and Tissue<br>Grasping Forceps  | 559-560        |

## E

|   |         |
|---|---------|
| Ear Catheter, Hartmann                  | 670     |
| Ear Curette, Buck                       | 676     |
| Ear Curette, Shapleigh                  | 676     |
| Ear Forceps, Grünwald                   | 671     |
| Ear Forceps, Jansen                     | 671     |
| Ear Forceps, Tröltzsch (Wilde)          | 671     |
| Ear Hooklet, Day                        | 678     |
| Ear Hooklet, Hartmann                   | 677     |
| Ear Hooklet, Lucae                      | 677     |
| Ear Hooklet, Wagener                    | 678     |
| Ear Loop, Billeau                       | 677     |
| Ear Polypus Forceps, Hartmann           | 672-673 |
| Ear Polypus Forceps, Hartmann-Herzfeld  | 673     |
| Ear Polypus Forceps, Hartmann-Hoffmann  | 673     |
| Ear Polypus Forceps, Hartmann-Wullstein | 673     |

|   |         |
|---|---------|
| Ear Polypus Forceps, Strümpel             | 673     |
| Ear Scoop, Jansen                         | 677     |
| Ear Scoop, Lempert                        | 679     |
| Ear Scoop/Hook, Gross                     | 677     |
| Ear Specula Storage Rack                  | 665     |
| Ear Specula, Set, Hartmann                | 664     |
| Ear Specula, Set, Toynbee                 | 664     |
| Ear Speculum, Farrior                     | 665     |
| Ear Speculum, Hartmann                    | 664     |
| Ear Speculum, Toynbee                     | 664     |
| Echlin, Bone Rongeur                      | 527     |
| Eicken-Killian, Antrum Irrigation Cannula | 720     |
| Eiselsberg, Stitch Scissors               | 108     |
| Elevator, Adson                           | 498     |
| Elevator, Langenbeck                      | 500     |
| Elevator, Martin-Langenbeck               | 500     |
| Elevator, Quervain                        | 501     |
| Elevator, Sebileau                        | 501     |
| Elevator, Williger                        | 501     |
| Emmett, Fistula Hook                      | 626     |
| Endocervical Speculum, Kogan              | 613     |
| Enterotomy Scissors                       | 106     |
| Enucleation Scissors                      | 103     |
| Episiotomy Scissors, Braun-Stadler        | 89      |
| Episiotomy Scissors, Waldmann             | 89      |
| Esmarch, Plaster Knife                    | 447     |
| Esmarch, Plaster Shears                   | 443     |
| Ethmoid Bone Forceps                      | 689     |
| Ethmoid Bone Forceps, Takahashi           | 688     |
| Ethmoid Bone Forceps, Watson-Williams     | 689     |
| Ethmoid Bone Forceps, Weil-Blakesley      | 690     |
| Eves, Tonsil Snare                        | 730     |
| Exchangeable Tip, Brünings                | 732-733 |
| Exchangeable Tip, Cordes                  | 733     |
| Exchangeable Tip, Fraenkel                | 732     |
| Exchangeable Tip, Krause                  | 733     |
| Exchangeable Tip, Lange                   | 733     |
| Exchangeable Tip, Seifert                 | 732     |
| Exploring Hook, Shea                      | 662     |

## F

|   |           |
|---|-----------|
| Face-lift Forceps, Martel-Rees                    | 170       |
| Face-lift Scissors                                | 66        |
| Face-lift Scissors, Aston                         | 45        |
| Face-lift Scissors, Gorney                        | 45, 119   |
| Face-lift Scissors, Gorney-Freeman                | 118       |
| Face-lift Scissors, Kaye                          | 44        |
| Face-lift Scissors, Peck-Joseph                   | 62-63     |
| Face-lift Scissors, Rees                          | 119       |
| Face-lift Scissors, Salyer                        | 107       |
| Farabeuf-Collin, Periosteal Elevator              | 491       |
| Farabeuf, Bone Holding Forceps                    | 516       |
| Farabeuf, Periosteal Elevator                     | 491       |
| Farabeuf, Retractor                               | 277       |
| Farrell, Cotton Applicator                        | 355       |
| Farrior, Ear Speculum                             | 665       |
| Faulkner, Curette double ended                    | 719       |
| Faure, Peritoneum Forceps                         | 210       |
| Faure, Uterine Biopsy Forceps                     | 628       |
| Favaloro, Vascular Scissors                       | 77        |
| Fehland, Sigmoid Anastomosis Forceps              | 577       |
| Feilchenfeld, Splinter Forceps                    | 154       |
| Fenestrated Blade, Balfour, Mod. USA              | 315       |
| Fergusson, Bone Holding Forceps                   | 513       |
| Fergusson, Suction Tube                           | 365-366   |
| Ferris-Smith-Kerrison, Sphenoid Bone Punch        | 697       |
| Finochietto, Dissecting and Ligature Forceps      | 198       |
| Finochietto, Needle Holder                        | 412, 423  |
| Finsen-Martin, Wound Spreaders,<br>self-retaining | 280       |
| Finsen, Wound Spreaders, self-retaining           | 280       |
| Fisch, Micro Dissector                            | 662       |
| Fisher, Tonsil Knife                              | 727       |
| Fistula Hook, Emmett                              | 626       |
| Fistula Hook, Simon                               | 626       |
| Fixation Arm, Martin-Rochard                      | 323       |
| Fixing device for hooks, Martin-Rochard           | 323       |
| Flap Knife, Plester                               | 659       |
| Fomon, Alar Hooklet                               | 715-716   |
| Fomon, Bone File                                  | 712, 714  |
| Fomon, Chisel                                     | 707       |
| Fomon, Nasal Scissors                             | 50, 83-84 |
| Fomon, Rhinoplastic Knife                         | 699       |
| Fom support, Hartmann                             | 668       |
| Foregger, Laryngoscope Blade                      | 397       |
| Foregger, Laryngoscope Blade                      | 392-393   |
| Foregger, Laryngoscope Set                        | 396       |
| Foregger, Laryngoscope Set                        | 391-392   |
| Foreign Body Forceps, Mathieu                     | 597       |

|                                     |         |
|-------------------------------------|---------|
| Foreign Body Instrument, Weber-Loch | 677     |
| Foreign Body Lever, Buck            | 672     |
| Foreign Body Lever, Zaufal          | 677     |
| Förster, Sponge Forceps             | 222-223 |
| Foster-Gillies, Needle Holder       | 428     |
| Fraenkel, Exchangeable Tip          | 732     |
| Frame, Kirschner                    | 317-319 |
| Frazier, Suction Tube               | 364     |
| Freer, Mucosa Hooklet               | 716     |
| Freer, Mucosa Knife                 | 700     |
| Freer, Septum Chisel                | 705     |
| Freer, Septum Elevator              | 701-702 |
| Freer, Septum Gouge                 | 705     |
| Freer, Septum Knife                 | 700     |
| French, Tuning Fork                 | 666     |
| Friedmann, Bone Rongeur             | 522     |
| Fritsch, Retractor                  | 257     |
| Frontal Sinus Dilator, Ritter-Halle | 720     |
| Frosch, Bone Holding Forceps        | 513     |
| Frykholm, Bone Rongeur              | 528     |
| Fuller, Introducing Forceps         | 658     |

## G

|   |          |
|---|----------|
| Gall Duct Dilator, Bakes                | 585      |
| Gall Stone Forceps, Blake               | 586      |
| Gall Stone Forceps, Desjardins          | 587      |
| Gall Stone Forceps, Mayo-Blake          | 586      |
| Gall Stone Forceps, Mixer               | 587      |
| Gall Stone Scoops, Luer-Körte           | 588      |
| Gauze Packer, Luniatzschek              | 728      |
| Gellhorn, Uterine Biopsy Forceps        | 628      |
| Gelpi, Wound Spreaders, self-retaining  | 303      |
| Gemini, Dissecting and Ligature Forceps | 192      |
| Gerald, Atraumatic Dressing Forceps     | 136      |
| Gerald, Dissecting Forceps              | 131, 142 |
| Gerald, Dressing Forceps                | 130      |
| Gil-Vernet, Saddle Hook                 | 233      |
| Gillies-Mini, Needle Holder             | 428      |
| Gillies, Dissecting Forceps             | 131, 140 |
| Gillies, Needle Holder                  | 414, 428 |
| Glabella Rasp, Aufricht                 | 712      |
| Goelet, Retractor                       | 279      |
| Goitre Enucleator, Kocher               | 550      |
| Goitre Grasping Forceps, Lahey          | 550      |
| Goldman-Fox, Gum Scissors               | 91       |
| Goldman-Fox, Operating Scissors         | 91       |
| Goldsmith (Thudichum), Nasal Speculum   | 680      |
| Good, Tonsil Scissors                   | 81       |
| Gorney-Freeman, Face-lift Scissors      | 118      |
| Gorney, Face-lift Scissors              | 45, 119  |
| Gosset-Baby, Abdominal Retractor        | 310      |
| Gosset, Abdominal Retractor             | 310-311  |
| Gosset, Central Blade                   | 310      |
| Gouge                                   | 457      |
| Gouge, Alexander                        | 459      |
| Gouge, Cobb                             | 470      |
| Gouge, Hibbs                            | 472      |
| Gouge, Lexer                            | 465      |
| Gouge, Lexer-Mini                       | 464      |
| Gouge, Partsch                          | 458      |
| Gouge, Stille                           | 461      |
| Gouge, Walter                           | 707      |
| Gouge, Zielke                           | 459      |
| Graefe, Micro Hooklet                   | 226      |
| Graig, Septum Forceps                   | 687      |
| Grave, Vaginal Speculum                 | 601      |
| Green-Armytage, Uterine Clamp           | 640      |
| Greene, Uterine Curette                 | 636      |
| Grooved Director                        | 351      |
| Grooved Director, Doyen                 | 351      |
| Grooved Director, Nelaton               | 351      |
| Gross-Maier, Dressing Forceps           | 220      |
| Gross, Ear Scoop/Hook                   | 677      |
| Grünwald (Jansen), Nasal Tampon Forceps | 686      |
| Grünwald, Ear Forceps                   | 671      |
| Guedel-Negus, Laryngoscope Blade        | 390      |
| Guedel-Negus, Laryngoscope Set          | 390      |
| Guide Needle, Redon                     | 379-380  |
| Guilen, Obturator                       | 720      |
| Guilen, Suction Raspatory               | 720      |
| Gum Scissors                            | 93-94    |
| Gum Scissors, Goldman-Fox               | 91       |
| Gum Scissors, La Grange                 | 93       |
| Gum Scissors, Locklin                   | 94       |
| Gunnar-Hey, Tube milking roller         | 215      |
| Guthrie, Skin Hook                      | 227      |
| Guttmann, Vaginal Speculum              | 601      |
| Guyon, Kidney Pedicle Clamp             | 199-200  |
| Guyon, Urethral Sound                   | 594      |

- Gynecological Scissors.....120-121  
 Gynecological Scissors, Doyen.....34  
 Gynecological Scissors, Sims.....30-31  
 Gynecological Scissors, Sims-Siebold.....35  
 Gynecological Scissors, Wertheim.....36
- H**  
 Haberer, Abdominal Spatula.....348  
 Haemostatic Forceps, Bengolea.....180  
 Haemostatic Forceps, Chaput.....168  
 Haemostatic Forceps, Crile.....175  
 Haemostatic Forceps, Crile-Rankin.....176  
 Haemostatic Forceps, Dandy.....176  
 Haemostatic Forceps, Dandy-Mosquito.....176  
 Haemostatic Forceps, Dunhill.....174  
 Haemostatic Forceps, Halsted-Mosquito.....171-172  
 Haemostatic Forceps, Hartmann.....171  
 Haemostatic Forceps, Kelly.....174  
 Haemostatic Forceps, Kelly-Rankin.....175  
 Haemostatic Forceps, Kocher.....179  
 Haemostatic Forceps, Kocher (Ochsner).....183-184  
 Haemostatic Forceps, Kocher-Nippon.....179  
 Haemostatic Forceps, Leriche.....173  
 Haemostatic Forceps, Lovelace.....176  
 Haemostatic Forceps, Mikro-Mosquito.....173  
 Haemostatic Forceps, Negus.....203  
 Haemostatic Forceps, Pean.....167, 178  
 Haemostatic Forceps, Pean (Rochester).....181-182  
 Haemostatic Forceps, Pean-Nippon.....178  
 Haemostatic Forceps, Pennington.....169  
 Haemostatic Forceps, Providence-Hospital.....173  
 Haemostatic Forceps, Rochester-Carmalt.....177  
 Haemostatic Forceps, Spencer-Wells.....167  
 Haemostatic Forceps, Tuffier.....168  
 Hajek, Sphenoid Bone Punch.....696  
 Halle, Bone Curette.....485  
 Halle, Septum Elevator.....701  
 Halsey, Needle Holder.....409, 420  
 Halsted-Mosquito, Haemostatic Forceps.....171, 172  
 Hand and Nail Brush, Martin-Aseptic.....742  
 Handle.....354, 369  
 Handle for Vaginal Speculum, Scherbak.....609-610  
 Handle, T-form, Nabatoff.....353  
 Handle, Yankauer.....372  
 Hank, Uterine Dilator.....617  
 Harrington, marTract.....339  
 Harrington, Retractor.....267  
 Hartmann-Halle, Nasal Speculum.....680  
 Hartmann-Herzfeld, Ear Polypus Forceps.....673  
 Hartmann-Hoffmann, Ear Polypus Forceps.....673  
 Hartmann-Wullestein, Ear Polypus Forceps.....673  
 Hartmann, Bone Rongeur.....523  
 Hartmann, Ear Catheter.....670  
 Hartmann, Ear Hooklet.....677  
 Hartmann, Ear Polypus Forceps.....672-673  
 Hartmann, Ear Specula, Set.....664  
 Hartmann, Ear Specula, Set.....664  
 Hartmann, Foot support.....668  
 Hartmann, Haemostatic Forceps.....171  
 Hartmann, Nasal Cutting Forceps.....693  
 Hartmann, Nasal Polypus Forceps.....686  
 Hartmann, Tonsil Punch.....731  
 Hartmann, Tuning Fork.....666-668  
 Hayes, Sigmoid Anastomosis Forceps.....576  
 Heaney, Hysterectomy Forceps.....204  
 Heaney, Needle Holder.....411, 422  
 Heavy Duty, Micro Needle Holder.....416  
 Hegar-Baumgartner, Needle Holder.....410, 420  
 Hegar-Vascular, Needle Holder.....425  
 Hegar, Needle Holder.....425  
 Hegar, Uterine Dilator.....614-616  
 Hegenbarth, Clip Applying Forceps.....439  
 Heiming, Kidney Stone Forceps.....584  
 Heiss, Dissecting and Ligature Forceps.....186  
 Hemorrhoidal Grasping Forceps, McGinvey.....582  
 Henke, Tonsil Elevator.....728  
 Henley, Central Blade.....293  
 Henley, Wound Spreaders, self-retaining.....293  
 Hennig, Plaster Spreader.....448  
 Heparin Flushing Needle.....381  
 Heparin Flushing Needle, Mock.....381, 384  
 Hepp-Scheidel, Micro Needle Holder.....415  
 Hepp-Scheidel, Tubal forceps.....147  
 Heymann, Nasal Scissors.....86-87  
 Heywood-Smith, Uterine Polypus Forceps.....623  
 Hibbs, Chisel.....471  
 Hibbs, Gouge.....472  
 Hibbs, Osteotome.....471-472  
 Hohenfellner, Dissecting Scissors.....49
- Hohmann, Bone Lever.....503-505  
 Hohmann, mini, Bone Lever.....502  
 Hoke, Osteotome.....471  
 Hook, Scoville.....321  
 Hooklet.....227-228, 230, 235  
 Hooklet, Langenbeck-Mini.....229  
 Hooklet, Meyerding.....230  
 Hooklet, Ragnell-Davis.....231  
 Hooklet, Senn-Green.....231  
 Hooklet, Senn-Miller.....231  
 Hooklet, Strandell-Stille.....234  
 Hopkins, Plaster Knife.....447  
 Hösel, Retractor.....255  
 Hospital Nurse Set.....744  
 House-Dieter, Malleus Nipper.....657  
 House, Micro Curette.....663  
 House, Micro Measuring Rod.....663  
 House, Suction adapter.....374  
 House, Suction Tube.....374  
 Howard, Septum Elevator.....703  
 Huber, Universal Handle.....632  
 Humby, Dermotome.....14  
 Humby, Spare Blade.....14  
 Hunter, Splinter Forceps.....154  
 Hurd, Tonsil Dissector/Retractor.....727  
 Hysterectomy Forceps, Heaney.....204  
 Hysterectomy Forceps, Moynihan.....207  
 Hysterectomy Forceps, Phaneuf.....204  
 Hysterectomy Forceps, Rogers.....206  
 Hysterectomy Forceps, Wertheim.....208
- I**  
 Incision Scissors.....23  
 Instrument Box.....759  
 Instrument Tray.....758  
 Interchangeable Tube, Brünings.....632  
 Interior Box.....752  
 Intestinal Anastomosis Clamp, De Martel-Wolfson.....566  
 Intestinal and Pylorus Clamp, Payr.....565  
 Intestinal and Pylorus Clamp, Payr-Baby.....565  
 Intestinal and Tissue Grasping Forceps, Allis.....556-557  
 Intestinal and Tissue Grasping Forceps, Allis-Adair.....557  
 Intestinal and Tissue Grasping Forceps, Allis-Baby.....556  
 Intestinal and Tissue Grasping Forceps, Babcock.....558-559  
 Intestinal and Tissue Grasping Forceps, Boys-Allis.....557  
 Intestinal and Tissue Grasping Forceps, Duval.....559-560  
 Intestinal and Tissue Grasping Forceps, Judd-Allis.....557  
 Intestinal and Tissue Grasping Forceps, Lockwood.....557  
 Intestinal and Tissue Grasping Forceps, Thoms-Allis.....557  
 Intestinal and Tissue Grasping Forceps, Williams.....558  
 Intestinal Clamp, Allen.....564  
 Intestinal Clamp, Doyen.....560  
 Intestinal Clamp, Doyen-Baby.....561, 571  
 Intestinal Clamp, Kocher.....563-564, 573-574  
 Intestinal Clamp, Mayo-Robson.....562, 572  
 Intestinal Clamp, Scudder.....575  
 Introducing Forceps, Fuller.....658  
 Iowa, Uterine Tenaculum Forceps.....621  
 Iris Scissors.....95-99  
 Iris Scissors, Jabaley.....100  
 Iris Scissors, Mod. Bonn.....96  
 Iris Scissors, Stevens.....101-102  
 Israel, Retractor.....242  
 Iterson, Tracheal Hook.....549  
 IUP Grasping Forceps.....632  
 Ives-Fansler, Anuscope.....579
- J**  
 Jabaley, Iris Scissors.....100  
 Jaboma, Dissecting Forceps.....135  
 Jaboma, Dressing Forceps.....135  
 Jaboma, Micro Needle Holder.....415  
 Jaboma, Micro Scissors.....105  
 Jackson, Tracheal Hook.....549  
 Jackson, Vaginal Speculum.....602  
 Jacobs, Uterine Tenaculum Forceps.....621  
 Jacobson, Bone Curette, double-ended.....486  
 Jameson, Dissecting Scissors.....69
- Jameson, Needle Holder.....412  
 Jamieson, Suction Tube.....377  
 Jansen, Bone Rongeur.....523  
 Jansen, Ear Forceps.....671  
 Jansen, Ear Scoop.....677  
 Jansen, Wound Spreaders, self-retaining.....281  
 Jeweler mod., Micro dilating Forceps.....150  
 Jeweler mod., Micro Forceps.....150  
 Jeweler Type Forceps.....144  
 Johns-Hopkins, Bulldog Clamp.....163  
 Johnson, Needle Holder.....413  
 Joll, Thyroid and Vaginal retractor.....303  
 Jones, Towel Clamp.....211  
 Joseph-Masing, Periosteal Elevator.....704  
 Joseph, Bone File.....711  
 Joseph, Mucosa Hooklet.....715-716  
 Joseph, Nasal Saw.....709  
 Joseph, Operating Scissors.....60-61  
 Joseph, Periosteal Elevator.....704  
 Joseph, Rhinoplastic Knife.....699  
 Joseph, Septum Elevator.....701  
 Judd-Allis, Intestinal and Tissue Grasping Forceps.....557  
 Judd-Masson, Bladder Retractor.....592
- K**  
 Kader, Abdominal Spatula.....275  
 Kahre-Williger, Periosteal Elevator.....494  
 Kallmorgen, Vaginal Retractor.....607  
 Kallmorgen, Vaginal Speculum.....607  
 Kaye, Face-lift Scissors.....44  
 Kaye, Scalpel Handle.....8  
 Kelly-Rankin, Haemostatic Forceps.....175  
 Kelly, Dissecting and Ligature Forceps.....202  
 Kelly, Haemostatic Forceps.....174  
 Kelly, Operating Scissors.....32-33  
 Kelly, Retractor.....253, 273  
 Kelly, Sphincteroscope.....581  
 Kelly, Uterine Polypus Forceps.....623  
 Kern, Bone Holding Forceps.....515  
 Kerrison, Antrum Punch.....698  
 Kevorkian, Uterine Biopsy Curette.....627  
 Kevorkian, Uterine Biopsy Forceps.....631  
 Key.....462  
 Key for Approximator.....160  
 Key, Periosteal Elevator.....491  
 Kidney Dish.....760  
 Kidney Pedicle Clamp, Guyon.....199-200  
 Kidney Stone Forceps, Heiming.....584  
 Kidney Stone Forceps, Randall.....584  
 Kielland, Obstetrical Forceps.....639  
 Killian-Claus, Septum Gouge.....705  
 Killian, Nasal Speculum.....681  
 Killian, Septum Elevator.....703  
 Killian, Septum Gouge.....705  
 Kilner, Alar Hooklet.....716  
 Kilner, Dissecting Scissors.....65  
 Kilner, Needle Holder.....419  
 Kirschner, Abdominal Retractor.....317-318  
 Kirschner, Blade.....317-319  
 Kirschner, Frame.....317-319  
 Kirschner, marTract.....334  
 Klapp, Retractor.....235  
 Kleinert-Kutz, Tendon Holding Forceps.....510  
 Knapp, Dissecting Scissors.....114  
 Knapp, Operating Scissors.....22  
 Knee Retractor, Blount.....507  
 Knee Retractor, Blount.....507  
 Knives, Virchow.....3  
 Knight, Septum Forceps.....687  
 Knurled nut.....518  
 Knurled screw, Rydel-Seiffert.....669  
 Kocher (Ochsner), Haemostatic Forceps.....183-184  
 Kocher-Langenbeck, Retractor.....248-249  
 Kocher-Nippon, Haemostatic Forceps.....179  
 Kocher, Goitre Enucleator.....550  
 Kocher, Haemostatic Forceps.....179  
 Kocher, Intestinal Clamp.....563-564, 573-574  
 Kocher, Retractor.....239, 247, 251, 258  
 Kogan, Endocervical Speculum.....613  
 König, Ligature Conductor.....437  
 König, Periosteal Elevator.....490  
 König, Tuning Fork.....669  
 Körte, Retractor.....241  
 Krause-Voss, Polypus Snare.....670, 684  
 Krause, Exchangeable Tip.....733  
 Krause, Polypus Snare.....670, 684  
 Krenkel, Cleft Palate Periosteal Raspatory.....701  
 Kressner, Septum Forceps.....718

# Index, alphabetical

## English

|  |                |   |                   |  |                        |
|--|----------------|---|-------------------|--|------------------------|
| Kristeller, Vaginal Retractor .....                          | 603-606        | Ligature Needle, Schmieden-Dick .....                     | 431               | marTract, Kirschner .....                              | 334                    |
| Kristeller, Vaginal Speculum .....                           | 603-606        | Ligature Scissors.....                                    | 111-112           | marTract, Langenbeck.....                              | 335-336, 339           |
| Kronecker, Ligature Needle .....                             | 432            | Lister, Bandage Scissors .....                            | 442, 446          | marTract, Richardson .....                             | 342                    |
| Kübler, Dissecting Scissors .....                            | 44             | Lister, Sinus Forceps.....                                | 219               | marTract, Roux .....                                   | 344                    |
| Kübler, Dressing Forceps .....                               | 134            | Liston-Key, Bone Cutting Forceps .....                    | 534               | marTract, St. Marks .....                              | 343                    |
| Kübler, Needle Holder .....                                  | 430            | Liston, Amputation Knife .....                            | 13                | marTract, Volkmann.....                                | 344                    |
| Kümmel, Abdominal Spatula .....                              | 275            | Liston, Bone Cutting Forceps .....                        | 530               | Masing, Periosteal Elevator .....                      | 704                    |
| <b>L</b>   |                |   |                   |  |                        |
| La Grange, Gum Scissors .....                                | 93             | Littauer, Cilia Forceps .....                             | 155               | Masson, Needle Holder .....                            | 412, 422               |
| Laborde, Tracheal Dilator.....                               | 548            | Littauer, Stitch Scissors .....                           | 108               | Mastoid Rongeur, Beyer.....                            | 675                    |
| Lahey, Bile Duct Clamp .....                                 | 198            | Little, Retractor .....                                   | 246               | Mastoid Rongeur, Citelli.....                          | 674                    |
| Lahey, Goitre Grasping Forceps .....                         | 550            | Liver Puncture Needle, Menghini .....                     | 384               | Mathieu, Foreign Body Forceps.....                     | 597                    |
| Lahey, Retractor.....  | 246            | Locklin, Gum Scissors.....                                | 94                | Mathieu, Needle Holder .....                           | 414, 428-429           |
| Lamotte-Mini, Osteotome .....                                | 466            | Lockwood, Intestinal and Tissue Grasping<br>Forceps ..... | 557               | Mathieu, Retractor .....                               | 279                    |
| Lamotte, Osteotome.....                                      | 467-468        | Lorenz, Bandage Scissors.....                             | 442               | Mayfield, Bone Rongeur.....                            | 526                    |
| Lamotte, Periosteal Elevator .....                           | 496            | Lorna, Towel Clamp .....                                  | 212               | Mayo-Blake, Gall Stone Forceps.....                    | 586                    |
| Laminectomy Retractor, Scoville .....                        | 320            | Lovelace, Haemostatic Forceps .....                       | 176               | Mayo-Harrington, Dissecting Scissors .....             | 29                     |
| Laminectomy Retractor, Scoville-Haverfield .....             | 320            | Low-Profile, Central Blade .....                          | 302               | Mayo-Hegar, Needle Holder .....                        | 411, 421               |
| Landolt, Periosteal Elevator.....                            | 490            | Low-Profile, Spring .....                                 | 302               | Mayo-Lexer, Dissecting Scissors .....                  | 116                    |
| Landolt, Suction Tube .....                                  | 370            | Low-Profile, Wound Spreaders, self-retaining .....        | 302               | Mayo-Noble, Dissecting Scissors .....                  | 29                     |
| Lane, Bone Holding Forceps .....                             | 519            | Lower, Dissecting and Ligature Forceps .....              | 198               | Mayo-Robson, Intestinal Clamp.....                     | 562, 572               |
| Lane, Stomach and Intestinal Anastomosis<br>Twin Clamp ..... | 568-569        | Lubet-Barbon, Nasal Tampon Forceps .....                  | 686               | Mayo-Stille, Dissecting Scissors .....                 | 26-28                  |
| Lane, Towel Clamp .....                                      | 213            | Lucae, Ear Hooklet .....                                  | 677               | Mayo, Dissecting Forceps .....                         | 146                    |
| Lange-Hohmann, Bone Lever .....                              | 505            | Lucae, Mallet.....  | 476               | Mayo, Operating Scissors .....                         | 24-25                  |
| Lange, Alar Hooklet .....                                    | 715            | Lucae, Socket .....                                       | 668               | Mayo, Safety Pin.....                                  | 754                    |
| Lange, Exchangeable Tip.....                                 | 733            | Lucae, Spare Button .....                                 | 668               | McDonald, Dissector, double-ended .....                | 501                    |
| Langenbeck-Green, Retractor.....                             | 245            | Lucae, Tuning Fork .....                                  | 668               | McGee, Micro Ear Hook .....                            | 661                    |
| Langenbeck-Mini, Hooklet .....                               | 229            | Lucae, Tympanum Needle.....                               | 678               | McGee, Wire Bending Forceps.....                       | 656                    |
| Langenbeck, Bone Holding Forceps.....                        | 513            | Luer-Körte, Gall Stone Scoops .....                       | 588               | McGinvey, Hemorrhoidal Grasping Forceps.....           | 582                    |
| Langenbeck, Elevator .....                                   | 500            | Luer, Bone Rongeur.....                                   | 525               | McIndoe, Dressing Forceps .....                        | 128, 131               |
| Langenbeck, marTract.....                                    | 335-336, 339   | Luer, Suction Tube.....                                   | 369               | McIntosh, Laryngoscope Blade.....                      | 394-395                |
| Langenbeck, Needle Holder .....                              | 430            | Luer, Tracheal Hook.....                                  | 549               | McIntosh, Laryngoscope Blade.....                      | 391                    |
| Langenbeck, Periosteal Elevator .....                        | 490            | Lukens, Thymus Retractor .....                            | 549               | McIntosh, Laryngoscope Set.....                        | 394                    |
| Langenbeck, Retractor .....                                  | 243-245        | Lumbar Puncture Needle, Tuohy.....                        | 382               | McIntosh, Laryngoscope Set.....                        | 391                    |
| Laryngeal Mirror.....  | 734            | Luniatshchek, Gauze Packer.....                           | 728               | McKenty, Septum Elevator .....                         | 701-702                |
| Laryngeal Mirror Handle .....                                | 735            | <b>M</b>  |                   |  |                        |
| Laryngeal Mirror, Michel .....                               | 735            | M. G. Hospital, Needle Holder .....                       | 411               | McQuigg-Mixer, Dissecting and<br>Ligature Forceps..... | 197                    |
| Laryngeal Tube, Brünings .....                               | 732            | Magill, Catheter Introducing Forceps.....                 | 388               | Mead, Bone Rongeur.....                                | 523                    |
| Laryngoscope Blade, Foregger .....                           | 397            | Mallet .....  | 477-480           | Mead, Mallet .....                                     | 477                    |
| Laryngoscope Blade, Foregger .....                           | 392-393        | Mallet, Collin .....                                      | 476               | Mead, Spare Facings .....                              | 477                    |
| Laryngoscope Blade, Guedel-Negus .....                       | 390            | Mallet, Cottle.....                                       | 476               | Measurer .....   | 757                    |
| Laryngoscope Blade, McIntosh.....                            | 394-395        | Mallet, Doyen .....                                       | 475               | Meeker, Dissecting and Ligature Forceps .....          | 203                    |
| Laryngoscope Blade, McIntosh.....                            | 391            | Mallet, Lucae.....  | 476               | Menghini, Liver Puncture Needle .....                  | 384                    |
| Laryngoscope Blade, Miller .....                             | 398-399        | Mallet, Mead.....   | 477               | Metal Catheter, female .....                           | 595                    |
| Laryngoscope Blade, Miller .....                             | 389            | Mallet, Partsch .....                                     | 478               | Metal Jar .....  | 759                    |
| Laryngoscope Set, Foregger .....                             | 396            | Mallet, Williger .....                                    | 475, 477          | Metzenbaum-Fino,<br>Delicate Dissecting Scissors.....  | 53-58, 113, 117        |
| Laryngoscope Set, Foregger .....                             | 391-392        | Malleus Nipper, House-Dieter .....                        | 657               | Metzenbaum-Lahey,<br>Delicate Dissecting Scissors..... | 117                    |
| Laryngoscope Set, Guedel-Negus .....                         | 390            | Maltz, Nasal Rasp .....                                   | 711, 713          | Metzenbaum-Nelson, Dissecting Scissors .....           | 40                     |
| Laryngoscope Set, McIntosh.....                              | 394            | Marquard, Bone Rongeur .....                              | 526               | Metzenbaum-Thorek, Dissecting Scissors .....           | 115                    |
| Laryngoscope Set, McIntosh.....                              | 391            | Martel-Rees, Face-lift Forceps .....                      | 170               | Metzenbaum, Dissecting Scissors .....                  | 37-44                  |
| Laryngoscope Set, Miller .....                               | 398            | Martin aquajet, Cleansing Tip .....                       | 762-763           | Metzenbaum, Needle Holder .....                        | 410                    |
| Laryngoscope Set, Miller .....                               | 389            | Martin aquajet, Water Jet Pistol .....                    | 762               | Meyering, Hooklet .....                                | 230                    |
| Laryngoscope Set, Miller-Baby .....                          | 389            | Martin Arm System, Martin .....                           | 322               | Michel, Clip Applying Forceps .....                    | 439                    |
| Lateral Blade .....  | 304-309        | Martin-Alloy, Tuning Fork .....                           | 667               | Michel, Clip Applying Forceps .....                    | 440                    |
| Lateral Blade, Alan-Parks .....                              | 580            | Martin-Aseptic, Hand and Nail Brush .....                 | 742               | Michel, Laryngeal Mirror .....                         | 735                    |
| Lateral Blade, Millin .....                                  | 593            | Martin-Cushing, Periosteal Elevator .....                 | 489               | Micro Curette, House .....                             | 663                    |
| Lawrence, Dissecting and Ligature Forceps .....              | 203            | Martin-Fuchsig, Dissecting and<br>Ligature Forceps .....  | 177               | Micro dilating Forceps, Jeweler mod. ....              | 150                    |
| Leksell-Stille, Bone Rongeur .....                           | 528            | Martin-Hoen, Periosteal Elevator.....                     | 488               | Micro Dissector, Fisch .....                           | 662                    |
| Lempert, Bone Rongeur .....                                  | 523            | Martin-Langenbeck, Elevator .....                         | 500               | Micro Dissector, Varady .....                          | 352                    |
| Lempert, Ear Scoop .....                                     | 679            | Martin-Langenbeck, Periosteal Elevator .....              | 488               | Micro Ear Forceps .....                                | 648, 650-652           |
| Lempert, Micro Ear Periosteal Elevator .....                 | 679            | Martin-Langenbeck, Cross Bar .....                        | 323               | Micro Ear Forceps, Mini-McGee .....                    | 649, 653               |
| Leriche, Haemostatic Forceps .....                           | 173            | Martin-Rochard, Fixation Arm .....                        | 323               | Micro Ear Hook .....                                   | 661-662                |
| Lewin, Bone Holding Forceps.....                             | 512            | Martin-Rochard, Fixing device for hooks.....              | 323               | Micro Ear Hook, Barbara .....                          | 660                    |
| Lewis, Nasal Rasp.....                                       | 712            | Martin-Rochard, Retractor .....                           | 323               | Micro Ear Hook, McGee .....                            | 661                    |
| Lexer-Baby, Dissecting Scissors.....                         | 51             | Martin-Rochard, Retractor System.....                     | 323               | Micro Ear Hook, Shambaugh .....                        | 662                    |
| Lexer-Fino, Delicate Dissecting Scissors.....                | 52             | Martin-Rochard, Sliding Clamp .....                       | 323               | Micro Ear Needle, Barbara .....                        | 660-661                |
| Lexer-Mini, Gouge .....                                      | 464            | Martin, Abdominal Spatula .....                           | 348               | Micro Ear Needle, Rosen .....                          | 660                    |
| Lexer-Mini, Osteotome .....                                  | 464            | Martin, Brush Dispenser.....                              | 742-743           | Micro Ear Periosteal Elevator, Lempert .....           | 679                    |
| Lexer, Dissecting Scissors .....                             | 46-48, 51, 115 | Martin, Cartilage Dispenser.....                          | 742-743           | Micro Ear Periosteal Elevator, Rosen .....             | 662                    |
| Lexer, Gouge .....   | 465            | Martin, Cartilage Seizing Forceps .....                   | 512               | Micro Ear Scissors, Bellucci .....                     | 654                    |
| Lexer, Osteotome .....                                       | 465            | Martin, Dressing Forceps .....                            | 219               | Micro Ear Scissors, Wullstein .....                    | 655                    |
| Lexer, Spongiosa Gouges.....                                 | 463            | Martin, Martin Arm System .....                           | 322               | Micro Forceps.....                                     | 129, 141, 149-152, 158 |
| Ligature Catcher, Modell Wien .....                          | 438            | Martin, Nasal Speculum .....                              | 681               | Micro Forceps with counterbalance .....                | 150                    |
| Ligature Conductor, Brunner .....                            | 435            | Martin, Needle Holder .....                               | 423               | Micro Forceps, Jeweler mod. ....                       | 150                    |
| Ligature Conductor, König .....                              | 437            | Martin, Pelvimeter .....                                  | 638               | Micro Hooklet, Graefe.....                             | 226                    |
| Ligature Conductor, Mod. Martin.....                         | 436            | Martin, Plaster Knife .....                               | 447               | Micro Hooklet, Rasse .....                             | 226                    |
| Ligature Conductor, Payr .....                               | 438            | Martin, Retractor .....                                   | 259               | Micro Measuring Rod, House.....                        | 663                    |
| Ligature Conductor, Schmieden.....                           | 436            | Martin, Tuning Fork.....                                  | 667               | Micro Needle Holder .....                              | 404-405, 415, 417      |
| Ligature Conductor, Schmieden-Payr.....                      | 436            | Martin, Universal Fixation Clamp.....                     | 322, 323          | Micro Needle Holder, Barraquer .....                   | 406-407, 419           |
| Ligature Forceps .....                                       | 171            | Martin, Waste Forceps .....                               | 768               | Micro Needle Holder,<br>Barraquer-Troutman .....       | 406                    |
| Ligature Fork .....  | 438            | Martin, Wire Cutting Scissors .....                       | 124               | Micro Needle Holder, Castroviejo.....                  | 408, 418-419           |
| Ligature Needle.....   | 432            | Martin, Wound Spreaders, self-retaining.....              | 301               | Micro Needle Holder, Castroviejo-Fino .....            | 407                    |
| Ligature Needle, Brunner .....                               | 435            | Martini, Needle Holder .....                              | 426-427           | Micro Needle Holder, Heavy Duty .....                  | 416                    |
| Ligature Needle, Cooper .....                                | 432            | marTract .....  | 326-339, 341, 345 | Micro Needle Holder, Hepp-Scheidel.....                | 415                    |
| Ligature Needle, Deschamps .....                             | 433-434        | marTract, Alan-Parks .....                                | 338               | Micro Needle Holder, Jaboma .....                      | 415                    |
| Ligature Needle, Kronecker .....                             | 432            | marTract, Breisky .....                                   | 340               | Micro Phlebotomizer, Varady.....                       | 352                    |
| Ligature Needle, Schmieden.....                              | 431            | marTract, Deaver.....                                     | 337               | Micro Ring Forceps .....                               | 150-152                |
|  |                | marTract, Harrington .....                                | 339               |  |                        |



|  |          |  |                    |  |          |
|--|----------|--|--------------------|--|----------|
| Periosteal Elevator, Masing .....              | 704      | Retractor, Kelly .....                         | 253, 273           | Satinsky, Vascular Scissors .....                    | 71       |
| Periosteal Elevator, Sedillot .....            | 490      | Retractor, Klapp .....                         | 235                | Sauerbruch, Needle Case .....                        | 751      |
| Periosteal Elevator, Semb .....                | 496      | Retractor, Kocher .....                        | 239, 247, 251, 258 | Sauerbruch, Retractor .....                          | 264      |
| Periosteal Elevator, Williger .....            | 494      | Retractor, Kocher-Langenbeck .....             | 248-249            | Sauerbruch, Waste Forceps .....                      | 768      |
| Peritoneum Forceps, Faure .....                | 210      | Retractor, Körte .....                         | 241                | Saw Blade .....                                      | 450      |
| Peritoneum Forceps, Mikulicz .....             | 209-210  | Retractor, Lahey .....                         | 246                | Scalp-Contour, Wound Spreaders, self-retaining ..... | 282      |
| Peritoneum Forceps, Mikulicz-Baby .....        | 209      | Retractor, Langenbeck .....                    | 243-245            | Scalpel Blade, sterile .....                         | 9        |
| Pestalozza, Placenta Scoop .....               | 642      | Retractor, Langenbeck-Green .....              | 245                | Scalpel Handle .....                                 | 5-8, 10  |
| Phaneuf, Hysterectomy Forceps .....            | 204      | Retractor, Little .....                        | 246                | Scalpel Handle, Collin .....                         | 6        |
| Phlebextractor, Varady .....                   | 352      | Retractor, Martin .....                        | 259                | Scalpel Handle, Kaye .....                           | 8        |
| Phlebodissector, Varady .....                  | 352      | Retractor, Martin-Rochard .....                | 323                | Scapula Retractor, Davidson .....                    | 261      |
| Piper, Obstetrical Forceps .....               | 639      | Retractor, Mathieu .....                       | 279                | Schädel, Towel Clamp .....                           | 211      |
| Placenta and Ovum Forceps, Sänger .....        | 640      | Retractor, Middeldorpf .....                   | 252, 256           | Schede, Bone Curette .....                           | 482      |
| Placenta and Ovum Forceps, Winter .....        | 640      | Retractor, Mikulicz .....                      | 273                | Scheibe, Organ Grasping Forceps .....                | 570      |
| Placenta Scoop, Cuzzi .....                    | 641      | Retractor, Mikulicz .....                      | 272                | Scherbak, Handle for Vaginal Speculum .....          | 609, 610 |
| Placenta Scoop, Pestalozza .....               | 642      | Retractor, Ollier .....                        | 240                | Scherbak, Specula Blade, only .....                  | 609      |
| Plaster Breaker, Wolff .....                   | 449      | Retractor, Parker .....                        | 278                | Scherbak, Vaginal Speculum .....                     | 610      |
| Plaster Knife, Esmarch .....                   | 447      | Retractor, Parker-Langenbeck .....             | 279                | Scherbak, Weight for Vaginal Speculum .....          | 610      |
| Plaster Knife, Hopkins .....                   | 447      | Retractor, Parker-Mott .....                   | 278                | Schink, Dermatome .....                              | 14       |
| Plaster Knife, Martin .....                    | 447      | Retractor, Richardson .....                    | 253                | Schink, Skin Fixing Plate .....                      | 14       |
| Plaster Scissors, Bruns .....                  | 444, 446 | Retractor, Richardson-Eastman .....            | 252                | Schink, Spare Blade .....                            | 14       |
| Plaster Shears, Bergmann .....                 | 443      | Retractor, Roux .....                          | 276                | Schmid, Vessel Irrigation Cannula .....              | 384      |
| Plaster Shears, Esmarch .....                  | 443      | Retractor, Roux-Baby .....                     | 277                | Schmieden-Dick, Ligature Needle .....                | 431      |
| Plaster Shears, Stille-Martin .....            | 445      | Retractor, Roux-Mini .....                     | 277                | Schmieden-Payr, Ligature Conductor .....             | 436      |
| Plaster Spreader, Hennig .....                 | 448      | Retractor, Sauerbruch .....                    | 264                | Schmieden-Taylor, Vascular Scissors .....            | 77       |
| Plaster Spreader, Quattro .....                | 448      | Retractor, Simon .....                         | 259                | Schmieden, Ligature Conductor .....                  | 436      |
| Plastic Probe Tip, Nabatoff .....              | 353      | Retractor, Volkmann .....                      | 236-238            | Schmieden, Ligature Needle .....                     | 431      |
| Plester, Flap Knife .....                      | 659      | Retractor, Wassmund .....                      | 241                | Schnidt, Dissecting and Ligature Forceps .....       | 177      |
| Plester, Suction cannula .....                 | 383      | Retractor, Zenker .....                        | 250                | Schnidt, Tonsil Forceps .....                        | 729      |
| Plester, Wound Spreaders, self-retaining ..... | 290      | Reynolds, Dissecting Scissors .....            | 67-68              | Schröder, Uterine Scoop .....                        | 633      |
| Politzer, Tympanum Needle .....                | 678      | Rhinoplastic Chisel, Silver .....              | 708                | Schröder, Uterine Tenaculum Forceps .....            | 619-620  |
| Polypus Snare, Krause .....                    | 670, 684 | Rhinoplastic Knife, Converse .....             | 699                | Schubert, Uterine Biopsy Forceps .....               | 628-629  |
| Polypus Snare, Krause-Voss .....               | 670, 684 | Rhinoplastic Knife, Cottle .....               | 699                | Schuhmacher, Umbilical Scissors .....                | 90       |
| Poole, Suction Tube .....                      | 373      | Rhinoplastic Knife, Fomon .....                | 699                | Schuknecht, Sickle Knife .....                       | 659      |
| Poppen, Suction Tube .....                     | 367      | Rhinoplastic Knife, Joseph .....               | 699                | Schumacher, Tip only .....                           | 632      |
| Potts-Smith, Dissecting Forceps .....          | 142      | Rib Raspatory, Doyen .....                     | 495                | Schumacher, Uterine Biopsy Forceps .....             | 632      |
| Potts-Smith, Dressing Forceps .....            | 130, 133 | Ricard, Abdominal Retractor .....              | 307                | Schweden-Modell, Dressing Forceps .....              | 128      |
| Potts-Smith, Vascular Scissors .....           | 74-75    | Ricard, Central Blade .....                    | 307                | Scoville-Haverfield, Laminectomy Retractor .....     | 320      |
| Pratt, Rectal Speculum .....                   | 579      | Ricard, Spreader, only .....                   | 307                | Scoville, Blade .....                                | 321      |
| Probe .....                                    | 350      | Richardson-Eastman, Retractor .....            | 252                | Scoville, Bone Curette .....                         | 484      |
| Probe, Bowman .....                            | 645      | Richardson, marTract .....                     | 342                | Scoville, Hook .....                                 | 321      |
| Probe, Stacke .....                            | 350      | Richardson, Retractor .....                    | 253                | Scoville, Laminectomy Retractor .....                | 320      |
| Prostatic Retractor, Young .....               | 589      | Richter, Clip Applying Forceps .....           | 440                | Screw .....  | 508      |
| Protection Cap, Rubin .....                    | 695      | Ring Stripper, Vollmar .....                   | 354                | Scudder, Intestinal Clamp .....                      | 575      |
| Protection Spectacle .....                     | 746      | Ritter-Halle, Frontal Sinus Dilator .....      | 720                | Sebileau, Elevator .....                             | 501      |
| Providence-Hospital, Haemostatic Forceps ..... | 173      | Roberts, Dissecting and Ligature Forceps ..... | 187                | Sedillot, Periosteal Elevator .....                  | 490      |
| Puttius, Bone Rasp .....                       | 473      | Rochester-Carmalt, Haemostatic Forceps .....   | 177                | Segond, Myoma Knife .....                            | 624      |
| Pylorus Spreader, Benson .....                 | 567      | Roeder, Towel Clamp .....                      | 212                | Seiffert, Exchangeable Tip .....                     | 732      |
| <b>Q</b>                                       |          | Roger, Septum Elevator .....                   | 704                | Sellheim, Obstetrical Lever .....                    | 640      |
| Quattro, Plaster Spreader .....                | 448      | Rogers, Hysterectomy Forceps .....             | 206                | Semb, Bone Holding Forceps .....                     | 515      |
| Quervain, Elevator .....                       | 501      | Rose, Tracheal Hook .....                      | 549                | Semb, Bone Rongeur .....                             | 526      |
| <b>R</b>                                       |          | Rosen, Circular Cut Knife .....                | 659                | Semb, Periosteal Elevator .....                      | 496      |
| Ragnell-Davis, Hooklet .....                   | 231      | Rosen, Micro Ear Needle .....                  | 660                | Semken, Dissecting Forceps .....                     | 131, 140 |
| Ragnell, Dissecting Scissors .....             | 123      | Rosen, Micro Ear Periosteal Elevator .....     | 662                | Semken, Dressing Forceps .....                       | 129      |
| Ramplay, Sponge Forceps .....                  | 223      | Ross, Aorta Retractor .....                    | 265                | Semm, Vaginal Speculum .....                         | 601      |
| Randall, Kidney Stone Forceps .....            | 584      | Round Metal Box .....                          | 760                | Senn-Green, Hooklet .....                            | 231      |
| Rasse, Bone Hooklet .....                      | 226      | Roux-Baby, Retractor .....                     | 277                | Senn-Miller, Hooklet .....                           | 231      |
| Rasse, Micro Hooklet .....                     | 226      | Roux-Mini, Retractor .....                     | 277                | Septum Chisel, Freer .....                           | 705      |
| Recamier, Uterine Curette .....                | 634      | Roux, marTract .....                           | 344                | Septum Elevator, Ballenger-Hajek .....               | 703      |
| Rectal Biopsy Forceps .....                    | 582      | Roux, Retractor .....                          | 276                | Septum Elevator, Cottle .....                        | 703-704  |
| Rectal Speculum, Czerny .....                  | 579      | Rubin, Osteotome .....                         | 707                | Septum Elevator, Freer .....                         | 701-702  |
| Rectal Speculum, Pratt .....                   | 579      | Rubin, Protection Cap .....                    | 695                | Septum Elevator, Halle .....                         | 701      |
| Rectal Speculum, Sims .....                    | 579      | Rubin, Septum Morselizer .....                 | 695                | Septum Elevator, Howard .....                        | 703      |
| Rectal Spreader, Alan-Parks .....              | 580      | Rumel, Dissecting and Ligature Forceps .....   | 193                | Septum Elevator, Joseph .....                        | 701      |
| Redon, Guide Needle .....                      | 379-380  | Ruskin-Liston, Bone Cutting Forceps .....      | 532                | Septum Elevator, Killian .....                       | 703      |
| Rees, Face-lift Scissors .....                 | 119      | Ruskin, Bone Rongeur .....                     | 526                | Septum Elevator, McKenty .....                       | 701-702  |
| Reposition Forceps .....                       | 512      | Russ, Modell, Dissecting Forceps .....         | 145                | Septum Elevator, Pennington .....                    | 704      |
| Reposition Forceps .....                       | 512, 514 | Rydel-Seiffert, Damper .....                   | 669                | Septum Elevator, Roger .....                         | 704      |
| Resano, Dissecting Forceps .....               | 147      | Rydel-Seiffert, Knurled screw .....            | 669                | Septum Forceps .....                                 | 670      |
| Resano, Sigmoid Anastomosis Forceps .....      | 578      | Rydel-Seiffert, Tuning Fork .....              | 669                | Septum Forceps .....                                 | 687      |
| Resection Knife .....                          | 13       | Rydel-Seiffert, Weights .....                  | 669                | Septum Forceps, Brünings .....                       | 687      |
| Retractor .....                                | 238      | Ryder (Martin), Needle Holder .....            | 423                | Septum Forceps, Caplan .....                         | 694      |
| Retractor System, Martin-Rochard .....         | 323      | Ryder-Vascular, Needle Holder .....            | 424                | Septum Forceps, Graig .....                          | 687      |
| Retractor, Brunner .....                       | 262-263  | <b>S</b>                                       |                    | Septum Forceps, Knight .....                         | 687      |
| Retractor, Collin-Hartmann .....               | 276      | Saddle Hook, Cottle .....                      | 717                | Septum Forceps, Kressner .....                       | 718      |
| Retractor, Coryllos .....                      | 260      | Saddle Hook, Cushing .....                     | 232                | Septum Forceps, Middleton-Jansen .....               | 694      |
| Retractor, Cushing .....                       | 231      | Saddle Hook, Desmarres .....                   | 229                | Septum Gouge, Ballenger .....                        | 705      |
| Retractor, Deaver .....                        | 268-270  | Saddle Hook, Gil-Vernet .....                  | 233                | Septum Gouge, Freer .....                            | 705      |
| Retractor, Doyen .....                         | 258      | Safety Pin, Mayo .....                         | 754                | Septum Gouge, Killian .....                          | 705      |
| Retractor, Doyen-Stille .....                  | 254      | Salyer, Cleft Palate Dissector .....           | 726                | Septum Gouge, Killian-Claus .....                    | 705      |
| Retractor, Farabeuf .....                      | 277      | Salyer, Cleft Palate Elevator .....            | 726                | Septum Knife, Freer .....                            | 700      |
| Retractor, Fritsch .....                       | 257      | Salyer, Cleft Palate Hooklet .....             | 726                | Septum Morselizer .....                              | 694      |
| Retractor, Goelet .....                        | 279      | Salyer, Dissecting Scissors .....              | 59, 107            | Septum Morselizer, Rubin .....                       | 695      |
| Retractor, Harrington .....                    | 267      | Salyer, Face-lift Scissors .....               | 107                | Septum Straightening Forceps, Asch .....             | 718      |
| Retractor, Hösel .....                         | 255      | Sänger, Placenta and Ovum Forceps .....        | 640                | Septum Straightening Forceps, Cottle-Walsham .....   | 718      |
| Retractor, Israel .....                        | 242      | Sanvenero, Operating Scissors .....            | 59                 | Shambaugh, Micro Ear Hook .....                      | 662      |
|  |          | Sarot, Dissecting and Ligature Forceps .....   | 187                | Shapleigh, Ear Curette .....                         | 676      |
|  |          | Sarot, Needle Holder .....                     | 421                | Shea Vein Graft, Dissecting Scissors .....           | 64       |
|  |          |  |                    | Shea, Exploring Hook .....                           | 662      |

- Short Micro Scissors .....70  
 Sickle Knife, Schuknecht .....659  
 Sickle Knife, Wullstein .....659  
 Siegert, Delicate Dissecting Scissors .....117  
 Sigmoid Anastomosis Forceps, Brunner .....575  
 Sigmoid Anastomosis Forceps, Fehland .....577  
 Sigmoid Anastomosis Forceps, Hayes .....576  
 Sigmoid Anastomosis Forceps, Resano .....578  
 Sigmoid Anastomosis Forceps, Veidenheimer .....577  
 Silicone Plate .....753  
 Silver, Dermatome .....14  
 Silver, Rhinoplastic Chisel .....708  
 Silver, Spare Blade .....14  
 Simon, Bone Curette .....484  
 Simon, Fistula Hook .....626  
 Simon, Retractor .....259  
 Simon, Uterine Scoop .....633  
 Simpson, Obstetrical Forceps .....638  
 Sims-Siebold, Gynecological Scissors .....35  
 Sims, Gynecological Scissors .....30-31  
 Sims, Rectal Speculum .....579  
 Sims, Uterine Curette .....634  
 Sims, Uterine Sound .....618  
 Sims, Vaginal Speculum .....602  
 Singley-Tuttle, Dissecting Forceps .....146  
 Sinus Forceps, Lister .....219  
 Skene, Uterine Tenaculum Forceps .....620  
 Skin Fixing Plate, Schink .....14  
 Skin Grasping Forceps, Cottle .....719  
 Skin Grasping Forceps, Ogura .....719  
 Skin Hook .....226  
 Skin Hook, Guthrie .....227  
 Skin Hook, O'Connor .....227  
 Sliding Clamp, Martin-Rochard .....323  
 Smith-Petersen, Osteotome .....469  
 Snare Wire .....670, 684, 730  
 Socket, Lucae .....668  
 Somer, Uterine Seizing Forceps .....625  
 Spare Blade, Humby .....14  
 Spare Blade, Schink .....14  
 Spare Blade, Silver .....14  
 Spare Blade, Stille-Martin .....445  
 Spare Bulb .....393  
 Spare Button, Lucae .....668  
 Spare facing .....478-479  
 Spare Facings, Mead .....477  
 Spare Glass .....743  
 Spare Screw .....462  
 Specula Blade, only, Scherbak .....609  
 Spencer-Wells, Haemostatic Forceps .....167  
 Spencer, Stitch Scissors .....108  
 Sphenoid Bone Punch, Ferris-Smith-Kerrison .....697  
 Sphenoid Bone Punch, Hajek .....696  
 Sphincteroscope, Kelly .....581  
 Spinal Retractor, Taylor .....507  
 Splinter Forceps .....153-154  
 Splinter Forceps, Feilchenfeld .....154  
 Splinter Forceps, Hunter .....154  
 Splinter Forceps, Peet .....156  
 Splinter Forceps, Stieglitz .....156  
 Sponge Forceps, Bergmann .....222  
 Sponge Forceps, Bozemann .....221  
 Sponge Forceps, Förster .....222-223  
 Sponge Forceps, Rampley .....223  
 Spongiosa Gouges, Lexer .....463  
 Spratt, Bone Curette .....483  
 Spreader, only, Ricard .....307  
 Spring, Low-Profile .....302  
 St. Marks, marTract .....343  
 St. Marks, Pelvis Retractor .....274  
 Stacked, Probe .....350  
 Stainless Steel Bowl .....757  
 Steinmann, Tendon Holding Forceps .....509  
 Stellbrink, Bone Rongeur .....522  
 Sterilizing Forceps .....750  
 Sterilizing Forceps, Cheattle .....750  
 Stevens, Iris Scissors .....101-102  
 Stieglitz, Splinter Forceps .....156  
 Stille-Barraya, Dissecting Forceps .....145  
 Stille-Liston, Bone Cutting Forceps .....532-533  
 Stille-Luer, Bone Rongeur .....529  
 Stille-Martin, Plaster Shears .....445  
 Stille-Martin, Spare Blade .....445  
 Stille-Ruskin, Bone Rongeur .....527  
 Stille, Bone Rongeur .....526  
 Stille, Chisel .....460  
 Stille, Dissecting Forceps .....139  
 Stille, Gouge .....461  
 Stille, Osteotome .....460-461  
 Stitch Scissors, Buck .....108  
 Stitch Scissors, Eiselsberg .....108  
 Stitch Scissors, Littauer .....108  
 Stitch Scissors, Northbent .....107  
 Stitch Scissors, O'Brian .....107  
 Stitch Scissors, Spencer .....108  
 Stockmann, Penis Clamp .....598  
 Stomach and Intestinal Anastomosis  
 Twin Clamp, Lane .....568-569  
 Stopcock, 3-Way .....385  
 Storing Cup .....753  
 Strabismus Scissors .....103  
 Strabismus Scissors, Westcott .....103  
 Strainer for Vaginal Speculum, Weissbarth .....612  
 Strandell-Stille, Hooklet .....234  
 Stratte, Needle Holder .....413, 426  
 Strauss, pair of flexible tubes only .....598  
 Strauss, Penis Clamp .....598  
 Strully, Neurosurgical Scissors .....77  
 Strümpel, Ear Polypus Forceps .....673  
 Struycken, Nasal Cutting Forceps .....691  
 Suction adapter, House .....374  
 Suction cannula .....383  
 Suction cannula, Plester .....383  
 Suction Curette .....636  
 Suction Curette, Novak .....627  
 Suction Handle, Coupland .....378  
 Suction Raspatory, Guilen .....720  
 Suction Tip, Coupland .....378  
 Suction Tip, Wullstein .....368  
 Suction Tip, Yankauer .....372  
 Suction Tip, Zoellner .....368  
 Suction Tube .....362-363-376  
 Suction Tube, Adson .....364  
 Suction Tube, Baby-Poole .....373  
 Suction Tube, Baby-Yankauer .....371  
 Suction Tube, Baron-Schuknecht .....369  
 Suction Tube, Byrd .....378  
 Suction Tube, Cogswell .....378  
 Suction Tube, Cooley .....375  
 Suction Tube, De Bakey-Adson .....371  
 Suction Tube, Fergusson .....365-366  
 Suction Tube, Frazier .....364  
 Suction Tube, House .....374  
 Suction Tube, Jamieson .....377  
 Suction Tube, Landolt .....370  
 Suction Tube, Luer .....369  
 Suction Tube, Nuboer .....377  
 Suction Tube, Poole .....373  
 Suction Tube, Poppen .....367  
 Suction Tube, Wullstein .....368  
 Suction Tube, Yankauer .....371-372  
 Suction Tube, Yankauer .....372  
 Suction Tube, Yasargil .....370  
 Suction Tube, Zoellner .....368  
 Suction valve, Cerullo .....370  
 Surgical Needle .....402  
 Surgical Needle .....403  
 Swivel headed scalpel handle .....6  
 Swivel Knife, Ballenger .....700
- T**  
 Tabb, Mucosa Knife .....659  
 Takahashi, Ethmoid Bone Forceps .....688  
 Tamper .....474  
 Tamper, Caspar .....474  
 Tangential Forceps, Uro-Tangential .....199  
 Taylor, Dissecting Forceps .....141  
 Taylor, Dressing Forceps .....129  
 Taylor, Spinal Retractor .....507  
 Teale, Uterine Tenaculum Forceps .....620  
 Tendon Holding Forceps .....510  
 Tendon Holding Forceps, Carroll .....509  
 Tendon Holding Forceps, Kleinert-Kutz .....510  
 Tendon Holding Forceps, Steinmann .....509  
 Tendon Interlacing Forceps .....510  
 Tendon Passer, Bunnell .....508  
 Tendon Passing Instrument .....508  
 Tendon Stripper .....508  
 Tendon Tunnelling Forceps .....509  
 Tendon Tunnelling Forceps, Brand .....509  
 Thoms-Allis, Intestinal and  
 Tissue Grasping Forceps .....557  
 Thoms-Gaylor, Uterine Biopsy Forceps .....629  
 Thorek, Dissecting Scissors .....50  
 Thread forceps, Ochsner .....438  
 Thymus Retractor, Lukens .....549  
 Thyroid and Vaginal Retractor, Joll .....303  
 Tieck-Halle, Nasal Speculum .....681
- Tip only, Schumacher .....632  
 Toennis-Adson, Delicate Dissecting Scissors .....78, 113  
 Toennis, Needle Holder .....429  
 Tohoku, Towel Clamp .....212  
 Tonsil Forceps, Schmidt .....729  
 Tonsil Dissector/Retractor, Hurd .....727  
 Tonsil Elevator, Henke .....728  
 Tonsil Grasping Forceps, Blohmke .....729  
 Tonsil Grasping Forceps, White .....729  
 Tonsil Knife, Brünings .....727  
 Tonsil Knife, Fisher .....727  
 Tonsil Needle .....382  
 Tonsil Punch, Hartmann .....731  
 Tonsil Scissors, Dean .....80, 82  
 Tonsil Scissors, Good .....81  
 Tonsil Snare, Brünings .....730  
 Tonsil Snare, Eves .....730  
 Tonsil Snare, Tyding .....730  
 Towel Clamp .....213  
 Towel Clamp, Backhaus .....211  
 Towel Clamp, Bernhard .....212  
 Towel Clamp, Jones .....211  
 Towel Clamp, Lane .....213  
 Towel Clamp, Lorna .....212  
 Towel Clamp, Peers-Bertram .....213  
 Towel Clamp, Peers-Bertram modif. ....212  
 Towel Clamp, Roeder .....212  
 Towel Clamp, Schädel .....211  
 Towel Clamp, Tohoku .....212  
 Toynbee, Ear Speculum .....664  
 Tracheal Dilator, Laborde .....548  
 Tracheal Dilator, Trousseau .....548  
 Tracheal Hook, Iterson .....549  
 Tracheal Hook, Jackson .....549  
 Tracheal Hook, Luer .....549  
 Tracheal Hook, Rose .....549  
 Traction Cable, Nabatoff .....353  
 Travers, Wound Spreaders, self-retaining .....283  
 Tröltzsch (Wilde), Ear Forceps .....671  
 Tröltzsch, Nasal Tampon Forceps .....686  
 Trousseau, Tracheal Dilator .....548  
 Troutman-Chris, Blade Holder / Blade Breaker .....4  
 Tubal forceps, Hepp-Scheidel .....147  
 Tube milking roller, Brompton .....215  
 Tube milking roller, Gunnar-Hey .....215  
 Tubing Clamp .....213-214  
 Tuffier, Haemostatic Forceps .....168  
 Tumor Grasping Forceps, Collin .....169  
 Tuning Fork .....669  
 Tuning Fork, French .....666  
 Tuning Fork, Hartmann .....666-668  
 Tuning Fork, König .....669  
 Tuning Fork, Lucae .....668  
 Tuning Fork, Martin .....667  
 Tuning Fork, Martin-Alloy .....667  
 Tuning Fork, Neuro .....669  
 Tuning Fork, Rydel-Seiffert .....669  
 Tunneling Forceps .....220  
 Tuohy, Lumbar Puncture Needle .....382  
 Tyding, Tonsil Snare .....730  
 Tympanum Needle, Lucae .....678  
 Tympanum Needle, Politzer .....678
- U**  
 Ulrich, Bone Holding Forceps .....517  
 Ulrich, Dressing Forceps .....218  
 Umbilical Cord Clamp, Collin .....642  
 Umbilical Scissors, Busch .....90  
 Umbilical Scissors, Mod. USA .....90  
 Umbilical Scissors, Schuhmacher .....90  
 Universal Fixation Clamp, Martin .....322, 323  
 Universal Handle, Huber .....632  
 Universal Tray .....758  
 Universal Tray .....758  
 Universal, Bandage Scissors .....444  
 Universal, Wire Cutting Scissors .....109  
 Urethral Sound, Guyon .....594  
 Urethral Sound, Van Buren .....594  
 Uro-Tangential, Tangential Forceps .....199  
 Uterine Biopsy Curette, Kevorkian .....627  
 Uterine Biopsy Curette, Mod. München .....627  
 Uterine Biopsy Forceps, Alexander .....631  
 Uterine Biopsy Forceps, Faure .....628  
 Uterine Biopsy Forceps, Gellhorn .....628  
 Uterine Biopsy Forceps, Kevorkian .....631  
 Uterine Biopsy Forceps, Schubert .....628-629  
 Uterine Biopsy Forceps, Schumacher .....631-632  
 Uterine Biopsy Forceps, Thoms-Gaylor .....629  
 Uterine Biopsy Forceps, Van Doren .....630

# Index, alphabetical

## English

- Uterine Clamp, Green-Armytage ..... 640  
 Uterine Curette, Greene ..... 636  
 Uterine Curette, Recamier ..... 634  
 Uterine Curette, Sims ..... 634  
 Uterine Depressor, Braun ..... 618  
 Uterine Dilator, Hank ..... 617  
 Uterine Dilator, Hegar ..... 614-616  
 Uterine Polypus Forceps, Heywood-Smith ..... 623  
 Uterine Polypus Forceps, Kelly ..... 623  
 Uterine Polypus Forceps, Noto ..... 623  
 Uterine Scoop, Blake ..... 633  
 Uterine Scoop, Schröder ..... 633  
 Uterine Scoop, Simon ..... 633  
 Uterine Seizing Forceps, Collin ..... 625  
 Uterine Seizing Forceps, Dartigues ..... 625  
 Uterine Seizing Forceps, Somer ..... 625  
 Uterine Sound, Sims ..... 618  
 Uterine Sound, Valleix ..... 618  
 Uterine Tenaculum Forceps ..... 622  
 Uterine Tenaculum Forceps, Braun ..... 619, 622  
 Uterine Tenaculum Forceps, Czerny ..... 622  
 Uterine Tenaculum Forceps, Duplay ..... 619  
 Uterine Tenaculum Forceps, Iowa ..... 621  
 Uterine Tenaculum Forceps, Jacobs ..... 621  
 Uterine Tenaculum Forceps, Museux ..... 621  
 Uterine Tenaculum Forceps, Schröder ..... 619-620  
 Uterine Tenaculum Forceps, Skene ..... 620  
 Uterine Tenaculum Forceps, Teale ..... 620
- V**  
 Vaginal Clamp, Wertheim-Cullen ..... 205  
 Vaginal Retractor, Doyen ..... 612  
 Vaginal Retractor, Kallmorgen ..... 607  
 Vaginal Retractor, Kristeller ..... 603-606  
 Vaginal Speculum, Auvard ..... 611  
 Vaginal Speculum, Breisky ..... 612  
 Vaginal Speculum, Collin ..... 600  
 Vaginal Speculum, Cosco ..... 600  
 Vaginal Speculum, Doyen ..... 608  
 Vaginal Speculum, Grave ..... 601  
 Vaginal Speculum, Guttman ..... 601  
 Vaginal Speculum, Jackson ..... 602  
 Vaginal Speculum, Kallmorgen ..... 607  
 Vaginal Speculum, Kristeller ..... 603-606  
 Vaginal Speculum, Pederson ..... 601  
 Vaginal Speculum, Scherbak ..... 610  
 Vaginal Speculum, Semm ..... 601  
 Vaginal Speculum, Sims ..... 602  
 Vaginal Speculum, Weissbarth ..... 612  
 Valleix, Uterine Sound ..... 618  
 Van Buren, Urethral Sound ..... 594  
 Van Doren, Uterine Biopsy Forceps ..... 630  
 Varady, Micro Dissector ..... 352  
 Varady, Micro Phlebextractor ..... 352  
 Varady, Mini Phlebextractor ..... 352  
 Varady, Phlebextractor ..... 352  
 Varady, Phlebodissector ..... 352  
 Varicose Vein Probe Set, Nabatoff ..... 353  
 Vascular Scissors ..... 71, 77  
 Vascular Scissors, De Bakay ..... 72  
 Vascular Scissors, Diethrich ..... 72  
 Vascular Scissors, Diethrich-Hegemann ..... 74  
 Vascular Scissors, Diethrich-Potts ..... 73  
 Vascular Scissors, Favaloro ..... 77  
 Vascular Scissors, Potts-Smith ..... 74-75  
 Vascular Scissors, Satinsky ..... 71  
 Vascular Scissors, Schmieden-Taylor ..... 77  
 Veidenheimer, Sigmoid Anastomosis Forceps ..... 577  
 Vein Cannula ..... 381  
 Vein Hook, Brom ..... 234  
 Verbrugge, Bone Holding Forceps ..... 520-521  
 Vessel Clip, Biemer ..... 158  
 Vessel Hook ..... 228  
 Vessel Irrigation Cannula, Schmid ..... 384  
 Virchow, Knives ..... 3  
 Volkman, Bone Curette ..... 481-482  
 Volkman, Bone Curette, double-ended ..... 486  
 Volkman, marTract ..... 344  
 Volkman, Retractor ..... 236-238  
 Vollmar, Ring Stripper ..... 354
- W**  
 Wachenfeldt, Clip Applying Forceps ..... 439  
 Wagener, Ear Hooklet ..... 678  
 Wagner, Operating Scissors ..... 92  
 Waldmann, Episiotomy Scissors ..... 89  
 Walter, Gouge ..... 707  
 Walter, Osteotome ..... 707  
 Wangenstein, Dressing Forceps ..... 134  
 Wangenstein, Needle Holder ..... 413, 424  
 Wassmund, Retractor ..... 241  
 Waste Bucket ..... 768  
 Waste Forceps, Martin ..... 768  
 Waste Forceps, Sauerbruch ..... 768  
 Water Jet Pistol, Martin aquajet ..... 762  
 Watson-Williams, Ethmoid Bone Forceps ..... 689  
 Waugh, Dissecting Forceps ..... 140  
 Waugh, Dressing Forceps ..... 128  
 Weber-Loch, Foreign Body Instrument ..... 677  
 Webster, Needle Holder ..... 409, 415, 419  
 Weight for Vaginal Speculum, Auvard ..... 611  
 Weight for Vaginal Speculum, Scherbak ..... 610  
 Weights, Rydel-Seiffert ..... 669  
 Weil-Blakesley, Ethmoid Bone Forceps ..... 690  
 Weil-Blakesley, Nasal Cutting Forceps ..... 690  
 Weil, Nasal Cutting Forceps ..... 689  
 Weissbarth, Strainer for Vaginal Speculum ..... 612  
 Weissbarth, Vaginal Speculum ..... 612  
 Weitlaner-Baby, Wound Spreaders, self-retaining ..... 292  
 Weitlaner-Wullstein, Wound Spreaders, self-retaining ..... 289  
 Weitlaner, Wound Spreaders, self-retaining ..... 284, 287-288  
 Wertheim-Cullen, Vaginal Clamp ..... 205  
 Wertheim, Gynecological Scissors ..... 36  
 Wertheim, Hysterectomy Forceps ..... 208  
 Westcott, Strabismus Scissors ..... 103  
 Westmacott, Nasal Tampon Forceps ..... 686  
 White, Tonsil Grasping Forceps ..... 729  
 Wikstroem, Dissecting and Ligature Forceps ..... 196  
 Williams, Intestinal and Tissue Grasping Forceps ..... 558  
 Williams, Wound Spreaders, self-retaining ..... 291  
 Williger, Bone Curette, double-ended ..... 487  
 Williger, Elevator ..... 501  
 Williger, Mallet ..... 475, 477  
 Williger, Periosteal Elevator ..... 494  
 Wing nut, Alan-Parks ..... 580  
 Winter, Placenta and Ovum Forceps ..... 640  
 Wire Bending Forceps, McGee ..... 656  
 Wire Cutting Scissors, Beebee ..... 110  
 Wire Cutting Scissors, Martin ..... 124  
 Wire Cutting Scissors, Universal ..... 109  
 Wire Loop, Brünings ..... 730  
 Wolff, Plaster Breaker ..... 449  
 Wound Spreaders, self-retaining ..... 280, 286-287, 302  
 Wound Spreaders, self-retaining, Adson ..... 285, 294-295, 298  
 Wound Spreaders, self-retaining, Alm ..... 281  
 Wound Spreaders, self-retaining, Anderson-Adson ..... 282  
 Wound Spreaders, self-retaining, Beckman-Adson ..... 299-300  
 Wound Spreaders, self-retaining, Beckmann ..... 298  
 Wound Spreaders, self-retaining, Cloward ..... 296-297  
 Wound Spreaders, self-retaining, Finsen ..... 280  
 Wound Spreaders, self-retaining, Finsen-Martin ..... 280  
 Wound Spreaders, self-retaining, Gelpi ..... 303  
 Wound Spreaders, self-retaining, Henley ..... 293  
 Wound Spreaders, self-retaining, Jansen ..... 281  
 Wound Spreaders, self-retaining, Low-Profile ..... 302  
 Wound Spreaders, self-retaining, Martin ..... 301  
 Wound Spreaders, self-retaining, Milligan ..... 292  
 Wound Spreaders, self-retaining, Mollison ..... 289  
 Wound Spreaders, self-retaining, Norfolk-Norwich ..... 283  
 Wound Spreaders, self-retaining, Plester ..... 290  
 Wound Spreaders, self-retaining, Scalp-Contour ..... 282  
 Wound Spreaders, self-retaining, Travers ..... 283  
 Wound Spreaders, self-retaining, Weitlaner ..... 284, 287-288  
 Wound Spreaders, self-retaining, Weitlaner-Baby ..... 292  
 Wound Spreaders, self-retaining, Weitlaner-Wullstein ..... 289  
 Wound Spreaders, self-retaining, Williams ..... 291  
 Wrigley, Obstetrical Forceps ..... 638  
 Wullstein, Micro Ear Scissors ..... 655  
 Wullstein, Sickle Knife ..... 659  
 Wullstein, Suction Tip ..... 368  
 Wullstein, Suction Tube ..... 368
- Y**  
 Yankauer, Handle ..... 372  
 Yankauer, Olive ..... 372  
 Yankauer, Suction Tip ..... 372  
 Yankauer, Suction Tube ..... 371-372  
 Yankauer, Suction Tube ..... 372
- Z**  
 Zaufal-Jansen, Bone Rongeur ..... 525  
 Zaufal, Foreign Body Lever ..... 677  
 Zenker, Dissecting and Ligature Forceps ..... 194  
 Zenker, Retractor ..... 250  
 Zielke, Gouge ..... 459  
 Zoellner, Suction Tip ..... 368  
 Zoellner, Suction Tube ..... 368
- Yasargil, Suction Tube ..... 370**  
**Young, Prostatic Retractor ..... 589**



Índice, alfabético  
**Español**



|  |                   |  |
|--|-------------------|--|
| <b>A</b>   |                   |  |
| Adaptador de aspiración, House.....                        | 374               |  |
| Adaptador para catéteres.....                              | 385               |  |
| Adlerkreutz, Pinza de disección con diente.....            | 139               |  |
| Adson-Baby, Pinza para preparación y ligadura.....         | 186               |  |
| Adson-Brown, Pinza de disección con diente.....            | 132, 142          |  |
| Adson, Elevador.....                                       | 498               |  |
| Adson, Pinza de disección.....                             | 128, 132          |  |
| Adson, Pinza de disección con diente.....                  | 132, 140          |  |
| Adson, Pinza para preparación y ligadura.....              | 177               |  |
| Adson, Porta-agujas.....                                   | 410               |  |
| Adson, Separador autoestático.....                         | 285, 294-295, 298 |  |
| Adson, Tubo de aspiración.....                             | 364               |  |
| Aguja de guía, Redon.....                                  | 379-380           |  |
| Aguja para amígdalas.....                                  | 382               |  |
| Aguja para heparin.....                                    | 381               |  |
| Aguja para heparin, Mock.....                              | 381, 384          |  |
| Aguja para ligadura.....                                   | 432               |  |
| Aguja para ligadura, Brunner.....                          | 435               |  |
| Aguja para ligadura, Cooper.....                           | 432               |  |
| Aguja para ligadura, Deschamps.....                        | 433-434           |  |
| Aguja para ligadura, Kronecker.....                        | 432               |  |
| Aguja para ligadura, Schmieden.....                        | 431               |  |
| Aguja para ligadura, Schmieden-Dick.....                   | 431               |  |
| Aguja para punción del hígado, Menghini.....               | 384               |  |
| Aguja para punción lumbar, Tuohy.....                      | 382               |  |
| Aguja para tímpano, Lucae.....                             | 678               |  |
| Aguja para tímpano, Politzer.....                          | 678               |  |
| Aguja quirúrgica.....                                      | 402               |  |
| Aguja quirúrgica.....                                      | 403               |  |
| Alambre.....   | 670, 684, 730     |  |
| Alan-Parks, marTract.....                                  | 338               |  |
| Alan-Parks, Separador rectal.....                          | 580               |  |
| Alan-Parks, Tuerca de mariposa.....                        | 580               |  |
| Alan-Parks, Valva central.....                             | 580               |  |
| Alan-Parks, Valva lateral.....                             | 580               |  |
| Alderdyce, Disector doble.....                             | 501               |  |
| Alexander, Cíncel.....                                     | 459               |  |
| Alexander, Gubia.....                                      | 459               |  |
| Alexander, Perióstótomo.....                               | 496               |  |
| Alexander, Pinza para biopsia.....                         | 631               |  |
| Allen, Pinza intestinal.....                               | 564               |  |
| Allis-Adair, Pinza para intestinos y tejidos.....          | 557               |  |
| Allis-Baby, Pinza para intestinos y tejidos.....           | 556               |  |
| Allis, Pinza para intestinos y tejidos.....                | 556-557           |  |
| Alm, Separador autoestático.....                           | 281               |  |
| Amniótomo, Beacham.....                                    | 619               |  |
| Anderson-Adson, Separador autoestático.....                | 282               |  |
| Anoscopio, Ives-Fansler.....                               | 579               |  |
| Apoyapiés, Hartmann.....                                   | 668               |  |
| Aproximador.....   | 160               |  |
| Aproximador, Biemer-Müller.....                            | 159               |  |
| Asa auricular, Billeau.....                                | 677               |  |
| Asa de alambre, Brünings.....                              | 730               |  |
| Asch, Pinza para enderezar el tabique nasal.....           | 718               |  |
| Aston, Tijera para Face-lift.....                          | 45                |  |
| Aufricht, Escofina para glabella.....                      | 712               |  |
| Aufricht, Separador nasal.....                             | 715, 717          |  |
| Austin, Disecador para el ático.....                       | 662               |  |
| Auvar, Espéculo vaginal.....                               | 611               |  |
| Auvar, Peso para espéculo vaginal.....                     | 611               |  |
| <b>B</b>   |                   |  |
| Babcock, Pinza para intestinos y tejidos.....              | 558-559           |  |
| Baby-Adson, Pinza para preparación y ligadura.....         | 170               |  |
| Baby-Poole, Tubo de aspiración.....                        | 373               |  |
| Baby-Yankauer, Tubo de aspiración.....                     | 371               |  |
| Backhaus, Pinza de campo.....                              | 211               |  |
| Bakes, Dilatador para conducto biliar.....                 | 585               |  |
| Balfour-Baby, Separador abdominal.....                     | 311               |  |
| Balfour-Standard, Separador abdominal.....                 | 314               |  |
| Balfour-Standard, Valva central.....                       | 312, 314-315      |  |
| Balfour, Mod. USA, Separador abdominal.....                | 315               |  |
| Balfour, Mod. USA, Valva de alambre.....                   | 315               |  |
| Balfour, Separador abdominal.....                          | 312-313           |  |
| Balfour, Valva central.....                                | 313               |  |
| Ballenger-Hajek, Elevador para tabique nasal.....          | 703               |  |
| Ballenger, Cuchillo para tabique nasal.....                | 700               |  |
| Ballenger, Gubia para tabique nasal.....                   | 705               |  |
| Bandeja para instrumentos.....                             | 758               |  |
| Bandeja universal.....                                     | 758               |  |
| Bandeja universal.....                                     | 758               |  |
| Barbara, Micro Aguja auricular.....                        | 660-661           |  |
| Barbara, Micro Ganchito auricular.....                     | 660               |  |
| Baron-Schuknecht, Tubo de aspiración.....                  | 369               |  |
| Barra transversal, Martin-Rochard.....                     | 323               |  |
| Barraquer-Trounman, Micro Porta-Agujas.....                | 406               |  |
| Barraquer, Micro Porta-Agujas.....                         | 406-407, 419      |  |
| Barraquer, Pinza depilatoria.....                          | 155               |  |
| Base de Bakelit.....                                       | 669               |  |
| Bastidor, suelto, Ricard.....                              | 307               |  |
| Beacham, Amniótomo.....                                    | 619               |  |
| Beckman-Adson, Separador autoestático.....                 | 299-300           |  |
| Beckmann, Cuchillo para adenoides.....                     | 720               |  |
| Beckman, Separador autoestático.....                       | 298               |  |
| Beebee, Tijera para cortar hilos de acero.....             | 110               |  |
| Beer, Pinza depilatoria.....                               | 155               |  |
| Bellucci, Micro Tijera auricular.....                      | 654               |  |
| Bengolea, Pinza hemostática.....                           | 180               |  |
| Bennett, Elevador para hueso.....                          | 506               |  |
| Benson, Separador para piloro.....                         | 567               |  |
| Bergmann, Pinza para tapones.....                          | 222               |  |
| Bergmann, Tijera para yeso.....                            | 443               |  |
| Bernhard, Pinza de campo.....                              | 212               |  |
| Beyer, Pinza cortante para hueso.....                      | 675               |  |
| Beyer, Pinza gubia.....                                    | 525               |  |
| Biemer-Müller, Aproximador.....                            | 159               |  |
| Biemer, Clip vascular.....                                 | 158               |  |
| Biemer, Micro Tijera.....                                  | 105               |  |
| Billeau, Asa auricular.....                                | 677               |  |
| Bircher-Ganske, Pinza para cartílago.....                  | 511               |  |
| Bisturí desechable.....                                    | 11-12             |  |
| Bisturí para disección.....                                | 2                 |  |
| Blake, Cucharilla uterina.....                             | 633               |  |
| Blake, Pinza para cálculos biliares.....                   | 586               |  |
| Blohmke, Pinza para amígdalas.....                         | 729               |  |
| Blount, Separador para rodilla.....                        | 507               |  |
| Blount, Separador para rodilla.....                        | 507               |  |
| Blumenthal, Pinza gubia.....                               | 524               |  |
| Böhler, Pinza cortante para hueso.....                     | 531               |  |
| Böhler, Pinza gubia.....                                   | 525               |  |
| Bombilla de recambio.....                                  | 393               |  |
| Bonney, Pinza de disección.....                            | 127               |  |
| Bonney, Pinza de disección con diente.....                 | 131, 146          |  |
| Borowski, Separador para aorta.....                        | 266               |  |
| Botón de repuesto, Lucae.....                              | 668               |  |
| Bowman, Sonda.....   | 645               |  |
| Boys-Allis, Pinza para intestinos y tejidos.....           | 557               |  |
| Bozemann, Pinza para tapones.....                          | 221               |  |
| Bozemann, Porta-agujas.....                                | 425               |  |
| Brand, Pinza para pasar tendones.....                      | 509               |  |
| Braun-Stadler, Tijera para episiotomía.....                | 89                |  |
| Braun, Depresor uterino.....                               | 618               |  |
| Braun, Pinza para cuello uterino.....                      | 619, 622          |  |
| Brazo de fijación, Martin-Rochard.....                     | 323               |  |
| Breisky, Espéculo vaginal.....                             | 612               |  |
| Breisky, marTract.....                                     | 340               |  |
| Brom, Ganchito para venas.....                             | 234               |  |
| Brompton, Pinza de rodillos.....                           | 215               |  |
| Brown, Porta-agujas.....                                   | 410               |  |
| Brünings, Asa de alambre.....                              | 730               |  |
| Brünings, Cierra-nudo para amígdalas.....                  | 730               |  |
| Brünings, Cuchillo.....                                    | 727               |  |
| Brünings, Pinza intercambiable.....                        | 732-733           |  |
| Brünings, Pinza para tabique nasal.....                    | 687               |  |
| Brünings, Tubo de extensión.....                           | 632               |  |
| Brünings, Tubo de laringeo.....                            | 732               |  |
| Brunner, Aguja para ligadura.....                          | 435               |  |
| Brunner, Pinza para anastomosis rectales.....              | 575               |  |
| Brunner, Separador.....                                    | 262-263           |  |
| Brunner, Sonda conductora.....                             | 435               |  |
| Bruns, Cucharilla cortante.....                            | 483-484           |  |
| Bruns, Tijera para yeso.....                               | 444, 446          |  |
| Bryant, Pinza para vendajes.....                           | 219               |  |
| Buck, Cureta auricular.....                                | 676               |  |
| Buck, Elevador para cuerpos extraños.....                  | 672               |  |
| Buck, Tijera para hilos.....                               | 108               |  |
| Bujia uretral, Guyon.....                                  | 594               |  |
| Bujia uretral, Van Buren.....                              | 594               |  |
| Bunnell, Sonda conductora de tendones.....                 | 508               |  |
| Busch, Tijera umbilical.....                               | 90                |  |
| Byrd, Tubo de aspiración.....                              | 378               |  |
| <b>C</b>   |                   |  |
| Cabezal para aspiración, Yankauer.....                     | 372               |  |
| Cable de tracción, Nabatoff.....                           | 353               |  |
| Caja interior.....   | 752               |  |
| Caja metálica redonda.....                                 | 760               |  |
| Caja para instrumentos.....                                | 759               |  |
| Cánula.....  | 381               |  |
| Cánula de aspiración.....                                  | 383               |  |
| Cánula de aspiración, Plester.....                         | 383               |  |
| Cánula para anestesia transvaginal.....                    | 381               |  |
| Cánula para irrigación vascular, Schmid.....               | 384               |  |
| Cánula para venas.....                                     | 381               |  |
| Caperuza protectora, Rubin.....                            | 695               |  |
| Caplan, Pinza para tabique nasal.....                      | 694               |  |
| Carroll, Pinza para coger tendones.....                    | 509               |  |
| Caspar, Punzón metálico.....                               | 474               |  |
| Castroviejo-Epker, Compas.....                             | 644               |  |
| Castroviejo-Fino, Micro Porta-Agujas.....                  | 407               |  |
| Castroviejo, Compas.....                                   | 644               |  |
| Castroviejo, Micro Porta-Agujas.....                       | 408, 418-419      |  |
| Castroviejo, Porta-hoja / Rompe-hoja de afeitar.....       | 4                 |  |
| Cepillo de limpieza.....                                   | 767               |  |
| Cepillo de limpieza.....                                   | 767               |  |
| Cepillo de limpieza.....                                   | 767               |  |
| Cepillo de limpieza.....                                   | 764-767           |  |
| Cepillo para uñas, Martin-Aseptik.....                     | 742               |  |
| Cerullo, Válvula de aspiración.....                        | 370               |  |
| Chaput, Pinza hemostática.....                             | 168               |  |
| Cheattle, Pinza para esterilización.....                   | 750               |  |
| Cheron, Pinza para vendajes.....                           | 221               |  |
| Childe, Pinza aproximadora.....                            | 439               |  |
| Cierra-nudo para amígdalas, Brünings.....                  | 730               |  |
| Cierra-nudo para amígdalas, Eves.....                      | 730               |  |
| Cierra-nudo para amígdalas, Tyding.....                    | 730               |  |
| Cíncel.....  | 457               |  |
| Cíncel.....  | 456               |  |
| Cíncel nasal, Silver.....                                  | 708               |  |
| Cíncel para tabique nasal, Freer.....                      | 705               |  |
| Cíncel, Alexander.....                                     | 459               |  |
| Cíncel, Fomon.....   | 707               |  |
| Cíncel, Hibbs.....   | 471               |  |
| Cíncel, Partsch.....                                       | 458               |  |
| Cíncel, Stille.....  | 460               |  |
| Cinceles de esponjosa, Lexer.....                          | 463               |  |
| Cinelli, Osteótomo.....                                    | 708               |  |
| Cinelli, Tijera nasal.....                                 | 50                |  |
| Citelli, Pinza cortante para hueso.....                    | 674               |  |
| Cizalla para yeso, Stille-Martin.....                      | 445               |  |
| Clamp Bulldog.....   | 162               |  |
| Clamp Bulldog, DeBaKey-Diethrich.....                      | 164               |  |
| Clamp Bulldog, Dieffenbach.....                            | 162               |  |
| Clamp Bulldog, Diethrich.....                              | 164               |  |
| Clamp Bulldog, Johns-Hopkins.....                          | 163               |  |
| Clamp Bulldog, Mini-Glover.....                            | 165-166           |  |
| Clamp para pene, Stockmann.....                            | 598               |  |
| Clamp para pene, Strauss.....                              | 598               |  |
| Clamp umbilical, Collin.....                               | 642               |  |
| Cleveland, Pinza cortante para hueso.....                  | 531               |  |
| Cleveland, Pinza gubia.....                                | 522               |  |
| Clip vascular, Biemer.....                                 | 158               |  |
| Cloward, Separador autoestático.....                       | 296-297           |  |
| Cloward, Valva.....  | 296-297           |  |
| Coakley, Cureta para el antro.....                         | 719               |  |
| Cobb, Gubia.....   | 470               |  |
| Cobb, Perióstótomo.....                                    | 492               |  |
| Cobo para desechos.....                                    | 768               |  |
| Cogswell, Tubo de aspiración.....                          | 378               |  |
| Collier, Porta-agujas.....                                 | 409               |  |
| Collin-Hartmann, Separador.....                            | 276               |  |
| Collin, Baby, Separador abdominal.....                     | 304, 307-308      |  |
| Collin, Clamp umbilical.....                               | 642               |  |
| Collin, Espéculo vaginal.....                              | 600               |  |
| Collin, Histerolabo.....                                   | 625               |  |
| Collin, Mango de bisturí.....                              | 6                 |  |
| Collin, Martillo.....                                      | 476               |  |
| Collin, Pinza para sacar órganos.....                      | 169               |  |
| Collin, Pinza para sacar órganos.....                      | 169               |  |
| Collin, Pinza para vendajes.....                           | 221               |  |
| Collin, Separador abdominal.....                           | 304-306           |  |
| Collin, Valva central.....                                 | 305-306           |  |
| Compas, Castroviejo.....                                   | 644               |  |
| Compas, Castroviejo-Epker.....                             | 644               |  |
| Conector.....  | 385               |  |
| Conector.....  | 385               |  |
| Converse, Cuchillo para rinoplástica.....                  | 699               |  |
| Converse, Ganchito para alas de nariz.....                 | 716               |  |
| Converse, Separador nasal.....                             | 716               |  |
| Converse, Tijera nasal.....                                | 88                |  |
| Cooley, Separador para atrio.....                          | 271               |  |
| Cooley, Tubo de aspiración.....                            | 375               |  |
| Cooper, Aguja para ligadura.....                           | 432               |  |
| Cordes, Pinza intercambiable.....                          | 733               |  |
| Coryllos, Separador.....                                   | 260               |  |
| Cottle-Kazanjan, Pinza cortante para hueso.....            | 530               |  |
| Cottle-Neivert, Ganchito para alas de nariz.....           | 717               |  |
| Cottle-Walsham, Pinza para enderezar el tabique nasal..... | 718               |  |
| Cottle, Cuchillo para rinoplástica.....                    | 699               |  |
| Cottle, Elevador para tabique nasal.....                   | 703-704           |  |
| Cottle, Escofina nasal.....                                | 711               |  |
| Cottle, Espéculo nasal.....                                | 682-683           |  |
| Cottle, Ganchito nasal.....                                | 715               |  |
| Cottle, Ganchito para alas de nariz.....                   | 717               |  |
| Cottle, Legra para tabique nasal.....                      | 704               |  |

|  |               |
|--|---------------|
| Cottle, Machacadora .....                                    | 710           |
| Cottle, Martillo .....                                       | 476           |
| Cottle, Osteótomo .....                                      | 706           |
| Cottle, Periostótomo .....                                   | 490           |
| Cottle, Pinza para columela .....                            | 719           |
| Cottle, Pinza para piel .....                                | 719           |
| Cottle, Separador en forma de silla .....                    | 717           |
| Cottle, Separador nasal .....                                | 717           |
| Cottle, Tijera nasal .....                                   | 85            |
| Coupland, Mango para tubos de aspiración .....               | 378           |
| Coupland, Punta de succión .....                             | 378           |
| Crafoord, Pinza para preparación y ligadura .....            | 188           |
| Crile-Murray, Porta-agujas .....                             | 410           |
| Crile-Rankin, Pinza hemostática .....                        | 176           |
| Crile-Wood, Porta-agujas .....                               | 410, 415, 420 |
| Crile, Pinza hemostática .....                               | 175           |
| Crile, Porta-agujas .....                                    | 414           |
| Cuadro, Kirschner .....                                      | 317-319       |
| Cubeta de acero inoxidable .....                             | 757           |
| Cucharas para cálculos biliares, Luer-Körte .....            | 588           |
| Cucharilla auricular, Jansen .....                           | 677           |
| Cucharilla auricular, Lempert .....                          | 679           |
| Cucharilla cortante .....                                    | 485           |
| Cucharilla cortante, Bruns .....                             | 483-484       |
| Cucharilla cortante, Daubenspeck .....                       | 482           |
| Cucharilla cortante, Halle .....                             | 485           |
| Cucharilla cortante, Modell USA .....                        | 485           |
| Cucharilla cortante, Schede .....                            | 482           |
| Cucharilla cortante, Scoville .....                          | 484           |
| Cucharilla cortante, Simon .....                             | 484           |
| Cucharilla cortante, Spratt .....                            | 483           |
| Cucharilla cortante, Volkman .....                           | 481-482       |
| Cucharilla de doble extremo .....                            | 486           |
| Cucharilla de doble extremo, Jacobson .....                  | 486           |
| Cucharilla de doble extremo, Volkman .....                   | 486           |
| Cucharilla de doble extremo, Williger .....                  | 487           |
| Cucharilla para aborto, Cuzzi .....                          | 641           |
| Cucharilla para aborto, Pestalozza .....                     | 642           |
| Cucharilla uterina, Blake .....                              | 633           |
| Cucharilla uterina, Schröder .....                           | 633           |
| Cucharilla uterina, Simon .....                              | 633           |
| Cucharilla/ganchito auricular, Gross .....                   | 677           |
| Cuchillo de hoz, Schuknecht .....                            | 659           |
| Cuchillo de hoz, Wullstein .....                             | 659           |
| Cuchillo para adenoides, Beckmann .....                      | 720           |
| Cuchillo para amputación, Liston .....                       | 13            |
| Cuchillo para cortes redondos, Rosen .....                   | 659           |
| Cuchillo para fibroma, Segond .....                          | 624           |
| Cuchillo para lóbulos, Plester .....                         | 659           |
| Cuchillo para mucosa, Freer .....                            | 700           |
| Cuchillo para mucosa, Tabb .....                             | 659           |
| Cuchillo para resección .....                                | 13            |
| Cuchillo para rinoplástica, Converse .....                   | 699           |
| Cuchillo para rinoplástica, Cottle .....                     | 699           |
| Cuchillo para tabique nasal, Ballenger .....                 | 700           |
| Cuchillo para tabique nasal, Freer .....                     | 700           |
| Cuchillo para yeso, Esmarch .....                            | 447           |
| Cuchillo para yeso, Hopkins .....                            | 447           |
| Cuchillo para yeso, Martin .....                             | 447           |
| Cuchillo rinoplástico, Fomon .....                           | 699           |
| Cuchillo rinoplástico, Joseph .....                          | 699           |
| Cuchillo, Brünings .....                                     | 727           |
| Cuchillo, Fisher .....                                       | 727           |
| Cuchillos, Virchow .....                                     | 3             |
| Cureta aspiradora .....                                      | 636           |
| Cureta aspiradora, Novak .....                               | 627           |
| Cureta auricular, Buck .....                                 | 676           |
| Cureta auricular, Shapleigh .....                            | 676           |
| Cureta de doble extremo, Faulkner .....                      | 719           |
| Cureta de doble extremo, Molt .....                          | 487           |
| Cureta para biopsia, Kevorkian .....                         | 627           |
| Cureta para biopsia, Mod. München .....                      | 627           |
| Cureta para el antro, Coakley .....                          | 719           |
| Cureta uterina, Greene .....                                 | 636           |
| Cureta uterina, Recamier .....                               | 634           |
| Cureta uterina, Sims .....                                   | 634           |
| Cusco, Espéculo vaginal .....                                | 600           |
| Cushing-Taylor, Pinza de disección .....                     | 133           |
| Cushing, Gancho en forma de silla .....                      | 232           |
| Cushing, Pinza de disección .....                            | 130, 133, 142 |
| Cushing, Separador .....                                     | 231           |
| Cuzzi, Cucharilla para aborto .....                          | 641           |
| Czerny, Espéculo rectal .....                                | 579           |
| Czerny, Pinza para cuello uterino .....                      | 622           |
| <b>D</b>   |               |
| Dandy-Mosquito, Pinza hemostática .....                      | 176           |
| Dandy, Pinza hemostática .....                               | 176           |
| Dartigues, Histerolabo .....                                 | 625           |
| Daubenspeck, Cucharilla cortante .....                       | 482           |
| Davidson, Separador para escápula .....                      | 261           |
| Day, Ganchito auricular .....                                | 678           |
| De Martel-Wolfson, Pinza para anastomosis intestinales ..... | 566           |
| De Martel-Wolfson, Pinza para cerrar grapas .....            | 566           |
| De Martel-Wolfson, Porta-clamp .....                         | 567           |
| Dean, Tijera para amígdalas .....                            | 80, 82        |
| Deaver, marTract .....                                       | 337           |
| Deaver, Separador .....                                      | 268-270       |
| Deaver, Tijera quirúrgica .....                              | 23            |
| DeBaKey-Adson, Tubo de aspiración .....                      | 371           |
| DeBaKey-Diethrich, Clamp Bulldog .....                       | 164           |
| DeBaKey, Pinza de disección atraumática .....                | 135-136       |
| DeBaKey, Porta-agujas .....                                  | 422           |
| DeBaKey, Tijera acodada .....                                | 122           |
| DeBaKey, Tijera de disección .....                           | 49            |
| DeBaKey, Tijera vascular .....                               | 72            |
| Depresor uterino, Braun .....                                | 618           |
| Derf, Porta-agujas .....                                     | 409, 419      |
| Dermatomo, Humby .....                                       | 14            |
| Dermatomo, Schink .....                                      | 14            |
| Dermatomo, Silver .....                                      | 14            |
| Deschamps, Aguja para ligadura .....                         | 433-434       |
| Desjardins, Pinza para cálculos biliares .....               | 587           |
| Desjardins, Pinza para conducto biliar .....                 | 201           |
| Desmarres, Gancho en forma de silla .....                    | 229           |
| Diapasón .....   | 669           |
| Diapasón, French .....                                       | 666           |
| Diapasón, Hartmann .....                                     | 666-668       |
| Diapasón, König .....  | 669           |
| Diapasón, Lucae .....  | 668           |
| Diapasón, Martin .....                                       | 667           |
| Diapasón, Martin-Alloy .....                                 | 667           |
| Diapasón, Neuro .....  | 669           |
| Diapasón, Rydel-Seiffert .....                               | 669           |
| Dieffenbach, Clamp Bulldog .....                             | 162           |
| Diethrich-Salyer, Tijera de disección .....                  | 72            |
| Diethrich, Clamp Bulldog .....                               | 164           |
| Diethrich, Tijera vascular .....                             | 72            |
| Dietrich-Hegemann, Tijera vascular .....                     | 74            |
| Dietrich-Potts, Tijera coronaria .....                       | 73            |
| Dietrich-Potts, Tijera vascular .....                        | 73            |
| Dilatador para conducto biliar, Bakes .....                  | 585           |
| Dilatador para el cuello vesical, Millin .....               | 592           |
| Dilatador para el seno maxilar, Ritter-Halle .....           | 720           |
| Dilatador traqueal, Laborde .....                            | 548           |
| Dilatador traqueal, Trousseau .....                          | 548           |
| Dilatador uterino, Hank .....                                | 617           |
| Dilatador uterino, Hegar .....                               | 614-616       |
| Dingmann, Pinza para cartilago .....                         | 511           |
| Disecador para el ático, Austin .....                        | 662           |
| Disecador para el paladar, Salyer .....                      | 726           |
| Disector doble .....   | 501           |
| Disector doble, Alderdyce .....                              | 501           |
| Disector doble, McDonald .....                               | 501           |
| Disector/separador para amígdalas, Hurd .....                | 727           |
| Dispensador de cepillos, Martin .....                        | 742-743       |
| Dittel, Instrumentos para inserción de catéter .....         | 388           |
| Douglas, Pinza depilatoria .....                             | 155           |
| Doyen-Baby, Pinza intestinal .....                           | 561, 571      |
| Doyen-Stille, Separador .....                                | 254           |
| Doyen, Espéculo vaginal .....                                | 608           |
| Doyen, Legra costal .....                                    | 495           |
| Doyen, Martillo .....  | 475           |
| Doyen, Pinza intestinal .....                                | 560           |
| Doyen, Separador .....                                       | 258           |
| Doyen, Sonda acanalada .....                                 | 351           |
| Doyen, Tijera para ginecología .....                         | 34            |
| Doyen, Tira-miomas .....                                     | 624           |
| Doyen, Valva vaginal .....                                   | 612           |
| Dunhill, Pinza hemostática .....                             | 174           |
| Duplay, Pinza para cuello uterino .....                      | 619           |
| Durante, Pinza de disección con diente .....                 | 145           |
| Duval, Pinza para intestinos y tejidos .....                 | 559-560       |
| <b>E</b>   |               |
| Echlin, Pinza gubia .....                                    | 527           |
| Eicken-Killian, Sonda irrigadora para seno maxilar .....     | 720           |
| Eiselsberg, Tijera para hilos .....                          | 108           |
| Elevador obstétrico, Selheim .....                           | 640           |
| Elevador para amígdalas, Henke .....                         | 728           |
| Elevador para cuerpos extraños, Buck .....                   | 672           |
| Elevador para cuerpos extraños, Zaufal .....                 | 677           |
| Elevador para el paladar, Salyer .....                       | 726           |
| Elevador para hueso .....                                    | 502           |
| Elevador para hueso, Bennett .....                           | 506           |
| Elevador para hueso, Hohmann .....                           | 503-505       |
| Elevador para hueso, Hohmann, mini .....                     | 502           |
| Elevador para hueso, Lange-Hohmann .....                     | 505           |
| Elevador para tabique nasal, Ballenger-Hajek .....           | 703           |
| Elevador para tabique nasal, Cottle .....                    | 703-704       |
| Elevador para tabique nasal, Freer .....                     | 701-702       |
| Elevador para tabique nasal, Halle .....                     | 701           |
| Elevador para tabique nasal, Howard .....                    | 703           |
| Elevador para tabique nasal, Joseph .....                    | 701           |
| Elevador para tabique nasal, Killian .....                   | 703           |
| Elevador para tabique nasal, McKenty .....                   | 701-702       |
| Elevador para tabique nasal, Pennington .....                | 704           |
| Elevador para tabique nasal, Roger .....                     | 704           |
| Elevador, Adson .....  | 498           |
| Elevador, Langenbeck .....                                   | 500           |
| Elevador, Martin-Langenbeck .....                            | 500           |
| Elevador, Quervain .....                                     | 501           |
| Elevador, Sebileau .....                                     | 501           |
| Elevador, Williger .....                                     | 501           |
| Emmett, Gancho para fístulas .....                           | 626           |
| Enucleador de tendones .....                                 | 508           |
| Escofina nasal, Cottle .....                                 | 711           |
| Escofina nasal, Fomon .....                                  | 712, 714      |
| Escofina nasal, Lewis .....                                  | 712           |
| Escofina nasal, Maltz .....                                  | 711, 713      |
| Escofina para glabella, Aufricht .....                       | 712           |
| Escofina para hueso, Putti .....                             | 473           |
| Esfinteroscopia, Kelly .....                                 | 581           |
| Esmarch, Cuchillo para yeso .....                            | 447           |
| Esmarch, Tijera para yeso .....                              | 443           |
| Espátula abdominal .....                                     | 348           |
| Espátula abdominal, Haberer .....                            | 348           |
| Espátula abdominal, Kader .....                              | 275           |
| Espátula abdominal, Kümmel .....                             | 275           |
| Espátula abdominal, Martin .....                             | 348           |
| Espéculo auricular, Farrior .....                            | 665           |
| Espéculo auricular, Hartmann .....                           | 664           |
| Espéculo auricular, juego, Hartmann .....                    | 664           |
| Espéculo auricular, juego, Toynebee .....                    | 664           |
| Espéculo auricular, Toynebee .....                           | 664           |
| Espéculo endocervical, Kogan .....                           | 613           |
| Espéculo nasal, Cottle .....                                 | 682-683       |
| Espéculo nasal, Goldsmith (Thudichum) .....                  | 680           |
| Espéculo nasal, Hartmann-Halle .....                         | 680           |
| Espéculo nasal, Killian .....                                | 681           |
| Espéculo nasal, Martin .....                                 | 681           |
| Espéculo nasal, Mod. Wien .....                              | 682           |
| Espéculo nasal, Tieck-Halle .....                            | 681           |
| Espéculo rectal, Czerny .....                                | 579           |
| Espéculo rectal, Pratt .....                                 | 579           |
| Espéculo rectal, Sims .....                                  | 579           |
| Espéculo vaginal, Auvard .....                               | 611           |
| Espéculo vaginal, Breisky .....                              | 612           |
| Espéculo vaginal, Collin .....                               | 600           |
| Espéculo vaginal, Cusco .....                                | 600           |
| Espéculo vaginal, Doyen .....                                | 608           |
| Espéculo vaginal, Grave .....                                | 601           |
| Espéculo vaginal, Guttman .....                              | 601           |
| Espéculo vaginal, Jackson .....                              | 602           |
| Espéculo vaginal, Kallmorgen .....                           | 607           |
| Espéculo vaginal, Kristeller .....                           | 603-606       |
| Espéculo vaginal, Pederson .....                             | 601           |
| Espéculo vaginal, Scherbak .....                             | 610           |
| Espéculo vaginal, Semm .....                                 | 601           |
| Espéculo vaginal, Sims .....                                 | 602           |
| Espéculo vaginal, Weissbarth .....                           | 612           |
| Espejo laringeo .....  | 734           |
| Espejo laringeo, Michel .....                                | 735           |
| Estuche para agujas .....                                    | 751-753       |
| Estuche para agujas, Sauerbruch .....                        | 751           |
| Estuche para laringoscopios .....                            | 393           |
| Eves, Cierra-nudo para amígdalas .....                       | 730           |
| <b>F</b>   |               |
| Farabeuf-Collin, Periostótomo .....                          | 491           |
| Farabeuf, Periostótomo .....                                 | 491           |
| Farabeuf, Pinza para huesos .....                            | 516           |
| Farabeuf, Separador .....                                    | 277           |
| Farrell, Porta-algodón .....                                 | 355           |
| Farrior, Espéculo auricular .....                            | 665           |
| Faulkner, Cureta de doble extremo .....                      | 719           |
| Faure, Pinza para biopsia .....                              | 628           |
| Faure, Pinza para peritoneo .....                            | 210           |
| Favaloro, Tijera vascular .....                              | 77            |
| Fehland, Pinza para anastomosis rectales .....               | 577           |
| Feilchenfeld, Pinza para espinas .....                       | 154           |
| Fergusson, Pinza para huesos .....                           | 513           |
| Fergusson, Tubo de aspiración .....                          | 365-366       |
| Ferris-Smith-Kerrison, Pinza sacabocado para esfenoid .....  | 697           |
| Finocchio, Pinza para preparación y ligadura .....           | 198           |

|  |                   |   |          |  |         |
|--|-------------------|---|----------|--|---------|
| Finochietto, Porta-agujas .....                    | 412, 423          | Gillies, Porta-agujas .....                                 | 414, 428 | Hepp-Scheidel, Pinza para tubos .....                  | 147     |
| Finsen-Martin, Separador autoestático .....        | 280               | Goelet, Separador .....                                     | 279      | Heymann, Tijera nasal .....                            | 86-87   |
| Finsen, Separador autoestático .....               | 280               | Goldman-Fox, Tijera quirúrgica .....                        | 91       | Heywood-Smith, Pinza para pólipos uterinos .....       | 623     |
| Fisch, Micro Discador .....                        | 662               | Goldman-Fox, Tijeras para encías .....                      | 91       | Hibbs, Cincel .....                                    | 471     |
| Fisher, Cuchillo .....                             | 727               | Goldsmith (Thudichum), Espéculo nasal .....                 | 680      | Hibbs, Gubia .....                                     | 472     |
| Fleboxtractor, Varady .....                        | 352               | Good, Tijera para amígdalas .....                           | 81       | Hibbs, Osteótomo .....                                 | 471-472 |
| Fleboxtractor, Varady .....                        | 352               | Gorney-Freeman, Tijera para Face-lift .....                 | 118      | Histerolabo, Collin .....                              | 625     |
| Fleboxtractor, Vollmar .....                       | 354               | Gorney, Tijera para Face-Lift .....                         | 45, 119  | Histerolabo, Dartigues .....                           | 625     |
| Fomon, Cincel .....                                | 707               | Gosset-Baby, Separador abdominal .....                      | 310      | Histerolabo, Somer .....                               | 625     |
| Fomon, Cuchillo rinoplástico .....                 | 699               | Gosset, Separador abdominal .....                           | 310-311  | Histerómetro, Sims .....                               | 618     |
| Fomon, Escofina nasal .....                        | 712, 714          | Gosset, Valva central .....                                 | 310      | Histerómetro, Valleix .....                            | 618     |
| Fomon, Ganchito para alas de nariz .....           | 715-716           | Graefe, Micro Ganchito .....                                | 226      | Hohenfellner, Tijera de disección .....                | 49      |
| Fomon, Tijera nasal .....                          | 50, 83-84         | Graig, Pinza para tabique nasal .....                       | 687      | Hohmann, Elevador para hueso .....                     | 503-505 |
| Forceps obstétricos, Kielland .....                | 639               | Grave, Espéculo vaginal .....                               | 601      | Hohmann, mini, Elevador para hueso .....               | 502     |
| Forceps obstétricos, Nägele .....                  | 638               | Green-Armytage, Pinza uterina para hemostasis .....         | 640      | Hoja de cincel .....                                   | 462     |
| Forceps obstétricos, Piper .....                   | 639               | Greene, Cureta uterina .....                                | 636      | Hoja de laringoscopia (luz fría), Foregger .....       | 397     |
| Forceps obstétricos, Simpson .....                 | 638               | Gross-Maier, Pinza para vendajes .....                      | 220      | Hoja de laringoscopia (luz fría), McIntosh .....       | 394-395 |
| Forceps obstétricos, Wrigley .....                 | 638               | Gross, Cucharilla/ganchito auricular .....                  | 677      | Hoja de laringoscopia (luz fría), Miller .....         | 398-399 |
| Foregger, Hoja de laringoscopia .....              | 392-393           | Grünwald (Jansen), Pinza para taponamiento .....            | 686      | Hoja de laringoscopia, Foregger .....                  | 392-393 |
| Foregger, Hoja de laringoscopia (luz fría) .....   | 397               | Grünwald, Pinza auricular .....                             | 671      | Hoja de laringoscopia, Guedel-Negus .....              | 390     |
| Foregger, Juego de laringoscopios .....            | 391-392           | Gubia .....   | 457      | Hoja de laringoscopia, McIntosh .....                  | 391     |
| Foregger, Juego de laringoscopios (luz fría) ..... | 396               | Gubia para tabique nasal, Ballenger .....                   | 705      | Hoja de laringoscopia, Miller .....                    | 389     |
| Förster, Pinza para tapones .....                  | 222-223           | Gubia para tabique nasal, Freer .....                       | 705      | Hoja de osteótomo .....                                | 462     |
| Foster-Gillies, Porta-agujas .....                 | 428               | Gubia para tabique nasal, Killian .....                     | 705      | Hoja de recambio, Stille-Martin .....                  | 445     |
| Fraenkel, Pinza intercambiable .....               | 732               | Gubia para tabique nasal, Killian-Claus .....               | 705      | Hoja de repuesto, Humby .....                          | 14      |
| Frazier, Tubo de aspiración .....                  | 364               | Gubia, Alexander .....                                      | 459      | Hoja de repuesto, Schink .....                         | 14      |
| Freer, Cincel para tabique nasal .....             | 705               | Gubia, Cobb .....   | 470      | Hoja de repuesto, Silver .....                         | 14      |
| Freer, Cuchillo para mucosa .....                  | 700               | Gubia, Hibbs .....  | 472      | Hoja de sierra .....                                   | 450     |
| Freer, Cuchillo para tabique nasal .....           | 700               | Gubia, Lexer .....  | 465      | Hojas de bisturí, estériles .....                      | 9       |
| Freer, Elevador para tabique nasal .....           | 701-702           | Gubia, Lexer-Mini .....                                     | 464      | Hoke, Osteótomo .....                                  | 471     |
| Freer, Ganchito para mucosa .....                  | 716               | Gubia, Partsch .....  | 458      | Hopkins, Cuchillo para yeso .....                      | 447     |
| Freer, Gubia para tabique nasal .....              | 705               | Gubia, Stille .....   | 461      | Horquilla de hilos .....                               | 438     |
| Freer, Gubia para tabique nasal .....              | 705               | Gubia, Walter .....   | 707      | Hösel, Separador .....                                 | 255     |
| French, Diapasón .....                             | 666               | Gubia, Zielke .....   | 459      | House-Dieter, Pinza para cabezal del maléolo .....     | 657     |
| Friedmann, Pinza gubia .....                       | 522               | Guedel-Negus, Hoja de laringoscopia .....                   | 390      | House, Adaptador de aspiración .....                   | 374     |
| Fritsch, Separador .....                           | 257               | Guedel-Negus, Juego de laringoscopios .....                 | 390      | House, Micro Cucharilla .....                          | 663     |
| Frosch, Pinza para huesos .....                    | 513               | Guilen, Legra de succión .....                              | 720      | House, Micro Sonda para medir .....                    | 663     |
| Frykholm, Pinza gubia .....                        | 528               | Guilen, Mandril .....                                       | 720      | House, Tubo de aspiración .....                        | 374     |
| Fuller, Pinza para introducir .....                | 658               | Gunnar-Hey, Pinza de rodillos .....                         | 215      | Howard, Elevador para tabique nasal .....              | 703     |
| <b>G</b>   |                   | Guthrie, Ganchito de piel .....                             | 227      | Huber, Mango universal .....                           | 632     |
| Gafa protectora .....                              | 746               | Guttman, Espéculo vaginal .....                             | 601      | Humby, Dermatomo .....                                 | 14      |
| Ganchito .....                                     | 227-228, 230, 235 | Guyon, Bujía uretral .....                                  | 594      | Humby, Hoja de repuesto .....                          | 14      |
| Ganchito auricular, Day .....                      | 678               | Guyon, Pinza para pedículo renal .....                      | 199-200  | Hunter, Pinza para espinas .....                       | 154     |
| Ganchito auricular, Hartmann .....                 | 677               | <b>H</b>  |          | Hurd, Disector/separador para amígdalas .....          | 727     |
| Ganchito auricular, Lucae .....                    | 677               | Haberer, Espátula abdominal .....                           | 348      | <b>I</b>   |         |
| Ganchito auricular, Wagener .....                  | 678               | Hajak, Pinza sacabocado para esfenoid .....                 | 696      | Imperdible para instrumentos, Mayo .....               | 754     |
| Ganchito de piel .....                             | 226               | Halle, Cucharilla cortante .....                            | 485      | Instrumento para circuncisión .....                    | 596     |
| Ganchito de piel, Guthrie .....                    | 227               | Halle, Elevador para tabique nasal .....                    | 701      | Instrumento para circuncisión, Mogen .....             | 596     |
| Ganchito de piel, O'Connor .....                   | 227               | Halsey, Porta-agujas .....                                  | 409, 420 | Instrumento para cuerpos extraños,<br>Weber-Loch ..... | 677     |
| Ganchito explorador, Shea .....                    | 662               | Halsted-Mosquito, Pinza hemostática .....                   | 171, 172 | Instrumentos para inserción de catéter, Dittel .....   | 388     |
| Ganchito nasal, Cottle .....                       | 715               | Hank, Dilatador uterino .....                               | 617      | Iowa, Pinza para cuello uterino .....                  | 621     |
| Ganchito para alas de nariz, Converse .....        | 716               | Harrington, marTract .....                                  | 339      | Israel, Separador .....                                | 242     |
| Ganchito para alas de nariz, Cottle .....          | 717               | Harrington, Separador .....                                 | 267      | Iterson, Gancho traqueal .....                         | 549     |
| Ganchito para alas de nariz, Cottle-Neivert .....  | 717               | Hartmann-Halle, Espéculo nasal .....                        | 680      | Ives-Fansler, Anoscopio .....                          | 579     |
| Ganchito para alas de nariz, Fomon .....           | 715-716           | Hartmann-Herzfeld, Pinza para pólipos<br>auriculares .....  | 673      | <b>J</b>   |         |
| Ganchito para alas de nariz, Kilner .....          | 716               | Hartmann-Hoffmann, Pinza para pólipos<br>auriculares .....  | 673      | Jabaley, Tijera para iridectomía .....                 | 100     |
| Ganchito para alas de nariz, Lange .....           | 715               | Hartmann-Wullstein, Pinza para pólipos<br>auriculares ..... | 673      | Jaboma, Micro Porta-Agujas .....                       | 415     |
| Ganchito para alas de nariz, Neivert .....         | 717               | Hartmann, Apoyapiés .....                                   | 668      | Jaboma, Micro Tijera .....                             | 105     |
| Ganchito para el paladar, Salyer .....             | 726               | Hartmann, Diapasón .....                                    | 666-668  | Jaboma, Pinza de disección .....                       | 135     |
| Ganchito para mucosa, Freer .....                  | 716               | Hartmann, Espéculo auricular, juego .....                   | 664      | Jaboma, Pinza de disección con diente .....            | 135     |
| Ganchito para mucosa, Joseph .....                 | 715-716           | Hartmann, Espéculo auricular, juego .....                   | 664      | Jackson, Espéculo vaginal .....                        | 602     |
| Ganchito para venas, Brom .....                    | 234               | Hartmann, Ganchito auricular .....                          | 677      | Jackson, Gancho traqueal .....                         | 549     |
| Ganchito vascular .....                            | 228               | Hartmann, Pinza gubia .....                                 | 523      | Jacobs, Pinza para cuello uterino .....                | 621     |
| Ganchito, Langenbeck-Mini .....                    | 229               | Hartmann, Pinza hemostática .....                           | 171      | Jacobson, Cucharilla de doble extremo .....            | 486     |
| Ganchito, Meyerding .....                          | 230               | Hartmann, Pinza nasal cortante .....                        | 693      | Jameson, Porta-agujas .....                            | 412     |
| Ganchito, Ragnell-Davis .....                      | 231               | Hartmann, Pinza para amígdalas .....                        | 731      | Jameson, Tijera de disección .....                     | 69      |
| Ganchito, Senn-Green .....                         | 231               | Hartmann, Pinza para pólipos auriculares .....              | 672-673  | Jamieson, Tubo de aspiración .....                     | 377     |
| Ganchito, Senn-Miller .....                        | 231               | Hartmann, Pinza para pólipos nasales .....                  | 686      | Jansen, Cucharilla auricular .....                     | 677     |
| Ganchito, Strandell-Stille .....                   | 234               | Hartmann, Sonda auricular .....                             | 670      | Jansen, Pinza auricular .....                          | 671     |
| Gancho en forma de silla, Cushing .....            | 232               | Hayes, Pinza para anastomosis rectales .....                | 576      | Jansen, Pinza gubia .....                              | 523     |
| Gancho en forma de silla, Desmarres .....          | 229               | Heaney, Pinza para histerectomía .....                      | 204      | Jansen, Separador autoestático .....                   | 281     |
| Gancho en forma de silla, Gil-Vernet .....         | 233               | Heaney, Pinza para agujas .....                             | 411, 422 | Jeweler mod., Micro Pinza .....                        | 150     |
| Gancho para fístulas, Emmett .....                 | 626               | Heavy Duty, Micro Porta-Agujas .....                        | 416      | Jeweler mod., Micro pinza de dilatación .....          | 150     |
| Gancho para fístulas, Simon .....                  | 626               | Hegar-Baumgartner, Porta-agujas .....                       | 410, 420 | Johns-Hopkins, Clamp Bulldog .....                     | 163     |
| Gancho para huesos, Rasse .....                    | 226               | Hegar-Vascular, Porta-agujas .....                          | 425      | Johnson, Porta-agujas .....                            | 413     |
| Gancho traqueal, Iterson .....                     | 549               | Hegar, Dilatador uterino .....                              | 614-616  | Joll, Separador para tiroides y vagina .....           | 303     |
| Gancho traqueal, Jackson .....                     | 549               | Hegar, Porta-agujas .....                                   | 425      | Jones, Pinza de campo .....                            | 211     |
| Gancho traqueal, Luer .....                        | 549               | Hegebarth, Pinza aplicadora para agrafes .....              | 439      | Joseph-Masing, Legra para tabique nasal .....          | 704     |
| Gancho traqueal, Rose .....                        | 549               | Heiming, Pinza para cálculos renales .....                  | 584      | Joseph, Cuchillo rinoplástico .....                    | 699     |
| Garrucha, Martin-Rochard .....                     | 323               | Heiss, Pinza para preparación y ligadura .....              | 186      | Joseph, Elevador para tabique nasal .....              | 701     |
| Gellhorn, Pinza para biopsia .....                 | 628               | Henke, Elevador para amígdalas .....                        | 728      | Joseph, Ganchito para mucosa .....                     | 715-716 |
| Gelpi, Separador autoestático .....                | 303               | Henley, Separador autoestático .....                        | 293      | Joseph, Legra para tabique nasal .....                 | 704     |
| Gemini, Pinza para preparación y ligadura .....    | 192               | Henley, Valva central .....                                 | 293      | Joseph, Lima para huesos .....                         | 711     |
| Gerald, Pinza de disección .....                   | 130               | Hennig, Separador para yeso .....                           | 448      | Joseph, Sierra nasal .....                             | 709     |
| Gerald, Pinza de disección atraumática .....       | 136               | Hepp-Scheidel, Micro Porta-Agujas .....                     | 415      | Joseph, Tijera quirúrgica .....                        | 60-61   |
| Gerald, Pinza de disección con diente .....        | 131, 142          |   |          | Judd-Allis, Pinza para intestinos y tejidos .....      | 557     |
| Gil-Vernet, Gancho en forma de silla .....         | 233               |   |          |  |         |
| Gillies-Mini, Porta-agujas .....                   | 428               |   |          |  |         |
| Gillies, Pinza de disección con diente .....       | 131, 140          |   |          |  |         |



|  |                        |
|--|------------------------|
| Meeker, Pinza para preparación y ligadura.....                 | 203                    |
| Menghini, Aguja para punción del hígado.....                   | 384                    |
| Metzenbaum-Fino, Tijera fina de disección.....                 | 53-58, 113, 117        |
| Metzenbaum-Lahey, Tijera fina de disección.....                | 117                    |
| Metzenbaum-Nelson, Tijera de disección.....                    | 40                     |
| Metzenbaum-Thorek, Tijera de disección.....                    | 115                    |
| Metzenbaum, Porta-agujas.....                                  | 410                    |
| Metzenbaum, Tijera de disección.....                           | 37-44                  |
| Meyerdig, Ganchito.....  | 230                    |
| Michel, Espejo laríngeo.....                                   | 735                    |
| Michel, Pinza aplicadora para agrafes.....                     | 439                    |
| Michel, Pinza aplicadora para agrafes.....                     | 440                    |
| Micro Aguja auricular, Barbara.....                            | 660-661                |
| Micro Aguja auricular, Rosen.....                              | 660                    |
| Micro Cucharilla, House.....                                   | 663                    |
| Micro Discador, Fisch.....                                     | 662                    |
| Micro Discador, Varady.....                                    | 352                    |
| Micro Fleboextractor, Varady.....                              | 352                    |
| Micro Ganchito auricular.....                                  | 661-662                |
| Micro Ganchito auricular, Barbara.....                         | 660                    |
| Micro Ganchito auricular, McGee.....                           | 661                    |
| Micro Ganchito auricular, Shambaugh.....                       | 662                    |
| Micro Ganchito, Graefe.....                                    | 226                    |
| Micro Ganchito, Rasse.....                                     | 226                    |
| Micro Legra auricular, Lempert.....                            | 679                    |
| Micro Legra auricular, Rosen.....                              | 662                    |
| Micro Pinza.....   | 129, 141, 149-152, 158 |
| Micro Pinza traumática.....                                    | 151                    |
| Micro Pinza auricular.....                                     | 648, 650-652           |
| Micro Pinza auricular, Mini-McGee.....                         | 649, 653               |
| Micro pinza de dilatación, Jeweler mod.....                    | 150                    |
| Micro Pinza de disección con ojal.....                         | 150-152                |
| Micro Pinza, Jeweler mod.....                                  | 150                    |
| Micro Porta-Agujas.....  | 404-405, 415, 417      |
| Micro Porta-Agujas, Barraquer.....                             | 406-407, 419           |
| Micro Porta-Agujas, Barraquer-Troutman.....                    | 406                    |
| Micro Porta-Agujas, Castroviejo.....                           | 408, 418-419           |
| Micro Porta-Agujas, Castroviejo-Fino.....                      | 407                    |
| Micro Porta-Agujas, Heavy Duty.....                            | 416                    |
| Micro Porta-Agujas, Hepp-Scheidel.....                         | 415                    |
| Micro Porta-Agujas, Jaboma.....                                | 415                    |
| Micro Sonda para medir, House.....                             | 663                    |
| Micro Tijera.....  | 76, 104-105            |
| Micro Tijera auricular, Bellucci.....                          | 654                    |
| Micro Tijera auricular, Wullstein.....                         | 655                    |
| Micro Tijera, Biemer.....                                      | 105                    |
| Micro Tijera, Jaboma.....                                      | 105                    |
| Micro-Tijeras, corto.....                                      | 70                     |
| Microvascular, Porta-agujas.....                               | 426                    |
| Middeldorff, Separador.....                                    | 252, 256               |
| Middleton-Jansen, Pinza para tabique nasal.....                | 694                    |
| Mikro-Adson, Pinza de disección.....                           | 143                    |
| Mikro-Adson, Pinza de disección con diente.....                | 143                    |
| Mikro-Adson, Pinza para preparación y ligadura.....            | 170                    |
| Mikro-Adson, Shigeno, Pinza de disección.....                  | 143                    |
| Mikro-Mosquito, Pinza hemostática.....                         | 173                    |
| Mikulicz-Baby, Pinza para peritoneo.....                       | 209                    |
| Mikulicz, Pinza para peritoneo.....                            | 209-210                |
| Mikulicz, Separador.....                                       | 273                    |
| Mikulicz, Separador.....                                       | 272                    |
| Miller-Baby, Juego de laringoscopios.....                      | 389                    |
| Miller-Colburn, Lima para huesos.....                          | 498-499                |
| Miller, Hoja de laringoscopia.....                             | 389                    |
| Miller, Hoja de laringoscopia (luz fría).....                  | 398-399                |
| Miller, Juego de laringoscopios.....                           | 389                    |
| Miller, Juego de laringoscopios (luz fría).....                | 398                    |
| Miller, Lima para alveolotomía.....                            | 499                    |
| Milligan, Separador autoestático.....                          | 292                    |
| Millin, Dilatador para el cuello vesical.....                  | 592                    |
| Millin, Pinza capsular.....                                    | 590-591                |
| Millin, Separador vesical.....                                 | 593                    |
| Millin, Valva central.....                                     | 593                    |
| Millin, Valva lateral.....                                     | 593                    |
| Mini Clip vascular.....  | 161                    |
| Mini Flebextractor, Varady.....                                | 352                    |
| Mini-Adson, Pinza de disección.....                            | 128                    |
| Mini-Adson, Pinza de disección con diente.....                 | 143                    |
| Mini-Gemini, Pinza para preparación y ligadura.....            | 192                    |
| Mini-Glover, Clamp Bulldog.....                                | 165-166                |
| Mini-Glover, Pinza para aplicar clips.....                     | 166                    |
| Mini-McGee, Micro Pinza auricular.....                         | 649, 653               |
| Mixter-Baby, Pinza para preparación y ligadura.....            | 170, 186, 194          |
| Mixter, Pinza para cálculos biliares.....                      | 587                    |
| Mixter, Pinza para preparación y ligadura.....                 | 195-197                |
| Mock, Aguja para heparin.....                                  | 381, 384               |
| Mod. Bonn, Tijera para iridectomía.....                        | 96                     |
| Mod. Martin, Pinza en tarro con tapa.....                      | 754                    |
| Mod. Martin, Sonda conductora.....                             | 436                    |
| Mod. München, Cureta para biopsia.....                         | 627                    |
| Mod. USA, Tijera umbilical.....                                | 90                     |
| Mod. Wien, Espéculo nasal.....                                 | 682                    |
| Modell USA, Cucharilla cortante.....                           | 485                    |
| Modell Wien, Porta-ligadura.....                               | 438                    |
| Mogen, Instrumento para circuncisión.....                      | 596                    |
| Mollison, Separador autoestático.....                          | 289                    |
| Molt, Cureta de doble extremo.....                             | 487                    |
| Mordaza universal, Martin.....                                 | 322, 323               |
| Moynihan, Pinza para histerectomía.....                        | 207                    |
| Museum, Pinza para cuello uterino.....                         | 621                    |
| <b>N</b>   |                        |
| Nabatoff, Cable de tracción.....                               | 353                    |
| Nabatoff, Juego para varices.....                              | 353                    |
| Nabatoff, Mango.....   | 353                    |
| Nabatoff, Oliva.....   | 353                    |
| Nabatoff, Punta plástica.....                                  | 353                    |
| Nägele, Forceps obstétricos.....                               | 638                    |
| Negus, Pinza hemostática.....                                  | 203                    |
| Neivert-Anderson, Osteótomo.....                               | 708                    |
| Neivert, Ganchito para alas de nariz.....                      | 717                    |
| Neivert, Porta-agujas.....                                     | 409                    |
| Nelaton, Sonda acanalada.....                                  | 351                    |
| Nelson, Pinza de disección con diente.....                     | 147                    |
| Neuro, Diapasón.....   | 669                    |
| Norfolk-Norwich, Separador autoestático.....                   | 283                    |
| Northbent, Tijera para hilos.....                              | 107                    |
| Noto, Pinza para pólipos uterinos.....                         | 623                    |
| Novak, Cureta aspiradora.....                                  | 627                    |
| Nuboer, Tubo de aspiración.....                                | 377                    |
| <b>O</b>   |                        |
| O'Brian, Tijera para hilos.....                                | 107                    |
| O'Connor, Ganchito de piel.....                                | 227                    |
| O'Shaughnessy, Pinza para preparación y ligadura.....          | 195                    |
| O'Sullivan-O'Connor, Separador abdominal.....                  | 316                    |
| O'Sullivan-O'Connor, Valva central.....                        | 316                    |
| Ochsner, Pinzas para ligaduras.....                            | 438                    |
| Oehler, Pinza de disección con diente.....                     | 134                    |
| Ogura, Pinza para piel.....                                    | 719                    |
| Oliva, Nabatoff.....   | 353                    |
| Oliva, Yankauer.....   | 372                    |
| Olivecrona, Tijera de disección.....                           | 79                     |
| Ollier, Separador.....   | 240                    |
| Olsen Hegar, Porta-agujas.....                                 | 414, 427               |
| Osteótomo.....   | 456                    |
| Osteótomo, Cinelli.....  | 708                    |
| Osteótomo, Cottle.....   | 706                    |
| Osteótomo, Hibbs.....  | 471-472                |
| Osteótomo, Hoke.....   | 471                    |
| Osteótomo, Lambotte.....                                       | 467-468                |
| Osteótomo, Lambotte-Mini.....                                  | 466                    |
| Osteótomo, Lexer.....  | 465                    |
| Osteótomo, Lexer-Mini.....                                     | 464                    |
| Osteótomo, Neivert-Anderson.....                               | 708                    |
| Osteótomo, Rubin.....  | 707                    |
| Osteótomo, Smith-Petersen.....                                 | 469                    |
| Osteótomo, Stille.....   | 460-461                |
| Osteótomo, Walter.....   | 707                    |
| Overholt-Baby, Pinza para preparación y ligadura.....          | 175                    |
| Overholt-Fino, Pinza para preparación y ligadura.....          | 190                    |
| Overholt-Geissendörfer, Pinza para preparación y ligadura..... | 189                    |
| Overholt-Martin, Pinza para preparación y ligadura.....        | 185                    |
| Overholt-Mini, Pinza para preparación y ligadura.....          | 191                    |
| Overholt-Mixter, Pinza para preparación y ligadura.....        | 186                    |
| Overholt, Pinza para preparación y ligadura.....               | 191                    |
| <b>P</b>   |                        |
| par de mangueras individuales, Strauss.....                    | 598                    |
| Par-Style, Porta-agujas.....                                   | 416                    |
| Parker-Langenbeck, Separador.....                              | 279                    |
| Parker-Mott, Separador.....                                    | 278                    |
| Parker, Separador.....   | 278                    |
| Partsch, Cíncel.....   | 458                    |
| Partsch, Gubia.....  | 458                    |
| Partsch, Martillo.....   | 478                    |
| Pasador de tendones.....                                       | 508                    |
| Payr-Baby, Pinza intestinal para píloro.....                   | 565                    |
| Payr, Pinza intestinal para píloro.....                        | 565                    |
| Payr, Sonda conductora.....                                    | 438                    |
| Pean (Rochester), Pinza hemostática.....                       | 181-182                |
| Pean-Nippon, Pinza hemostática.....                            | 178                    |
| Pean, Pinza hemostática.....                                   | 167, 178               |
| Peck-Joseph, Tijera para Face-lift.....                        | 62-63                  |
| Pederson, Espéculo vaginal.....                                | 601                    |
| Pedestal, Lucae.....   | 668                    |
| Peers-Bertram modif., Pinza de campo.....                      | 212                    |
| Peers-Bertram, Pinza de campo.....                             | 213                    |
| Peet, Pinza para espinas.....                                  | 156                    |
| Pelvímetro, Martin.....  | 638                    |
| Pennington, Elevador para tabique nasal.....                   | 704                    |
| Pennington, Pinza hemostática.....                             | 169                    |
| Percy, Retractor para amputación.....                          | 521                    |
| Periostótomo.....  | 493-494                |
| Periostótomo, Alexander.....                                   | 496                    |
| Periostótomo, Cobb.....  | 492                    |
| Periostótomo, Cottle.....                                      | 490                    |
| Periostótomo, Farabeuf.....                                    | 491                    |
| Periostótomo, Farabeuf-Collin.....                             | 491                    |
| Periostótomo, Kahre-Williger.....                              | 494                    |
| Periostótomo, Key.....   | 491                    |
| Periostótomo, König.....                                       | 490                    |
| Periostótomo, Lambotte.....                                    | 496                    |
| Periostótomo, Landolt.....                                     | 490                    |
| Periostótomo, Langenbeck.....                                  | 490                    |
| Periostótomo, Martin-Cushing.....                              | 489                    |
| Periostótomo, Martin-Hoen.....                                 | 488                    |
| Periostótomo, Martin-Langenbeck.....                           | 488                    |
| Periostótomo, Sedillot.....                                    | 490                    |
| Periostótomo, Semb.....  | 496                    |
| Periostótomo, Williger.....                                    | 494                    |
| Pesas, Rydel-Seiffert.....                                     | 669                    |
| Peso para espéculo vaginal, Auvard.....                        | 611                    |
| Peso para espéculo vaginal, Scherbak.....                      | 610                    |
| Pestalozza, Cucharilla para aborto.....                        | 642                    |
| Phaneuf, Pinza para histerectomía.....                         | 204                    |
| Pieza de acoplamiento.....                                     | 636                    |
| Pinza aplicadora para agrafes, Hegenbarth.....                 | 439                    |
| Pinza aplicadora para agrafes, Michel.....                     | 439                    |
| Pinza aplicadora para agrafes, Michel.....                     | 440                    |
| Pinza aplicadora para agrafes, Richter.....                    | 440                    |
| Pinza aplicadora para agrafes, Wachenfeldt.....                | 439                    |
| Pinza aproximadora, Child.....                                 | 439                    |
| Pinza auricular, Grünwald.....                                 | 671                    |
| Pinza auricular, Jansen.....                                   | 671                    |
| Pinza auricular, Trölsch (Wilde).....                          | 671                    |
| Pinza capsular, Millin.....                                    | 590-591                |
| Pinza cortante para hueso, Beyer.....                          | 675                    |
| Pinza cortante para hueso, Böhrler.....                        | 531                    |
| Pinza cortante para hueso, Citelli.....                        | 674                    |
| Pinza cortante para hueso, Cleveland.....                      | 531                    |
| Pinza cortante para hueso, Cottle-Kazanjan.....                | 530                    |
| Pinza cortante para hueso, Liston.....                         | 530                    |
| Pinza cortante para hueso, Liston-Key.....                     | 534                    |
| Pinza cortante para hueso, Ruskin-Liston.....                  | 532                    |
| Pinza cortante para hueso, Stille-Liston.....                  | 532-533                |
| Pinza cuticular.....   | 745                    |
| Pinza de campo.....  | 213                    |
| Pinza de campo, Backhaus.....                                  | 211                    |
| Pinza de campo, Bernhard.....                                  | 212                    |
| Pinza de campo, Jones.....                                     | 211                    |
| Pinza de campo, Lane.....                                      | 213                    |
| Pinza de campo, Lorna.....                                     | 212                    |
| Pinza de campo, Peers-Bertram.....                             | 213                    |
| Pinza de campo, Peers-Bertram modif.....                       | 212                    |
| Pinza de campo, Roeder.....                                    | 212                    |
| Pinza de campo, Schädel.....                                   | 211                    |
| Pinza de campo, Tohoku.....                                    | 212                    |
| Pinza de disección.....  | 126-127, 148           |
| Pinza de disección traumática, DeBakey.....                    | 135-136                |
| Pinza de disección traumática, Gerald.....                     | 136                    |
| Pinza de disección con diente.....                             | 137-139, 143, 148      |
| Pinza de disección con diente, Adlerkreutz.....                | 139                    |
| Pinza de disección con diente, Adson.....                      | 132, 140               |
| Pinza de disección con diente, Adson-Brown.....                | 132, 142               |
| Pinza de disección con diente, Bonney.....                     | 131, 146               |
| Pinza de disección con diente, Cushing.....                    | 142                    |
| Pinza de disección con diente, Durante.....                    | 145                    |
| Pinza de disección con diente, Gerald.....                     | 131, 142               |
| Pinza de disección con diente, Gillies.....                    | 131, 140               |
| Pinza de disección con diente, Jaboma.....                     | 135                    |
| Pinza de disección con diente, Mayo.....                       | 146                    |
| Pinza de disección con diente, Mikro-Adson.....                | 143                    |
| Pinza de disección con diente, Mini-Adson.....                 | 143                    |
| Pinza de disección con diente, Nelson.....                     | 147                    |
| Pinza de disección con diente, Oehler.....                     | 134                    |
| Pinza de disección con diente, Potts-Smith.....                | 142                    |

|   |          |   |                  |  |               |
|---|----------|---|------------------|--|---------------|
| Pinza de disección con diente, Resano .....         | 147      | Pinza intercambiable, Seiffert .....                            | 732              | Pinza para etmoides .....  | 689           |
| Pinza de disección con diente, Russ. Modell .....   | 145      | Pinza intestinal para piloro, Payr .....                        | 565              | Pinza para etmoides, Takahashi .....                               | 688           |
| Pinza de disección con diente, Semken .....         | 131, 140 | Pinza intestinal para piloro, Payr-Baby .....                   | 565              | Pinza para etmoides, Watson-Williams .....                         | 689           |
| Pinza de disección con diente, Singley-Tuttle ..... | 146      | Pinza intestinal, Allen .....                                   | 564              | Pinza para etmoides, Weil-Blakesley .....                          | 690           |
| Pinza de disección con diente, Stille .....         | 139      | Pinza intestinal, Doyen .....                                   | 560              | Pinza para Face-lift, Martel-Rees .....                            | 170           |
| Pinza de disección con diente, Stille-Barraya ..... | 145      | Pinza intestinal, Doyen-Baby .....                              | 561, 571         | Pinza para hemorroides, McGinvey .....                             | 582           |
| Pinza de disección con diente, Taylor .....         | 141      | Pinza intestinal, Kocher .....                                  | 563-564, 573-574 | Pinza para hilos .....   | 171           |
| Pinza de disección con diente, Waugh .....          | 140      | Pinza intestinal, Mayo-Robson .....                             | 562, 572         | Pinza para histerectomía, Heaney .....                             | 204           |
| Pinza de disección, Adson .....                     | 128, 132 | Pinza intestinal, Scudder .....                                 | 575              | Pinza para histerectomía, Moynihan .....                           | 207           |
| Pinza de disección, Bonney .....                    | 127      | Pinza micro con contrapeso .....                                | 150              | Pinza para histerectomía, Phaneuf .....                            | 204           |
| Pinza de disección, Cushing .....                   | 130, 133 | Pinza nasal cortante, Hartmann .....                            | 693              | Pinza para histerectomía, Rogers .....                             | 206           |
| Pinza de disección, Kübler .....                    | 133      | Pinza nasal cortante, Struycen .....                            | 691              | Pinza para histerectomía, Wertheim .....                           | 208           |
| Pinza de disección, Gerald .....                    | 130      | Pinza nasal cortante, Weil .....                                | 689              | Pinza para huesos .....  | 514           |
| Pinza de disección, Jaboma .....                    | 135      | Pinza nasal cortante, Weil-Blakesley .....                      | 690              | Pinza para huesos .....  | 511, 518      |
| Pinza de disección, Kübler .....                    | 134      | Pinza para aborto, Sängner .....                                | 640              | Pinza para huesos .....  | 512           |
| Pinza de disección, McIndoe .....                   | 128, 131 | Pinza para aborto, Winter .....                                 | 640              | Pinza para huesos, Farabeuf .....                                  | 516           |
| Pinza de disección, Mikro-Adson .....               | 143      | Pinza para amígdalas, Blohmke .....                             | 729              | Pinza para huesos, Fergusson .....                                 | 513           |
| Pinza de disección, Mikro-Adson, Shigeno .....      | 143      | Pinza para amígdalas, Hartmann .....                            | 731              | Pinza para huesos, Frosch .....                                    | 513           |
| Pinza de disección, Mini-Adson .....                | 128      | Pinza para amígdalas, Schmidt .....                             | 729              | Pinza para huesos, Kern .....                                      | 515           |
| Pinza de disección, Potts-Smith .....               | 130, 133 | Pinza para amígdalas, White .....                               | 729              | Pinza para huesos, Lane .....                                      | 519           |
| Pinza de disección, Schweden-Modell .....           | 128      | Pinza para anastomosis intestinales,<br>De Martel-Wolfson ..... | 566              | Pinza para huesos, Langenbeck .....                                | 513           |
| Pinza de disección, Semken .....                    | 129      | Pinza para anastomosis rectales, Fehland .....                  | 577              | Pinza para huesos, Lewin .....                                     | 512           |
| Pinza de disección, Taylor .....                    | 129      | Pinza para anastomosis rectales, Hayes .....                    | 576              | Pinza para huesos, Semb .....                                      | 515           |
| Pinza de disección, Wangenstein .....               | 134      | Pinza para anastomosis rectales, Resano .....                   | 578              | Pinza para huesos, Ulrich .....                                    | 517           |
| Pinza de disección, Waugh .....                     | 128      | Pinza para anastomosis rectales, Veidenheimer .....             | 577              | Pinza para huesos, Verbrugge .....                                 | 520-521       |
| Pinza de relojero .....                             | 144      | Pinza para anastomosis rectales, Brunner .....                  | 575              | Pinza para intestinos y tejidos, Allis .....                       | 556-557       |
| Pinza de rodillos, Brompton .....                   | 215      | Pinza para aplastamiento .....                                  | 694              | Pinza para intestinos y tejidos, Allis-Adair .....                 | 557           |
| Pinza de rodillos, Gunnar-Hey .....                 | 215      | Pinza para aplastamiento, Rubin .....                           | 695              | Pinza para intestinos y tejidos, Allis-Baby .....                  | 556           |
| Pinza depilatoria .....                             | 155      | Pinza para aplicar clips .....                                  | 158              | Pinza para intestinos y tejidos, Babcock .....                     | 558-559       |
| Pinza depilatoria, Barraquer .....                  | 155      | Pinza para aplicar clips .....                                  | 161              | Pinza para intestinos y tejidos, Boys-Allis .....                  | 557           |
| Pinza depilatoria, Beer .....                       | 155      | Pinza para aplicar clips, Mini-Glover .....                     | 166              | Pinza para intestinos y tejidos, Duval .....                       | 559-560       |
| Pinza depilatoria, Douglas .....                    | 155      | Pinza para aplicar clips, Mayo-Blake .....                      | 582              | Pinza para intestinos y tejidos, Judd-Allis .....                  | 557           |
| Pinza depilatoria, Littauer .....                   | 155      | Pinza para biopsia, Alexander .....                             | 631              | Pinza para intestinos y tejidos, Lockwood .....                    | 557           |
| Pinza en tarro con tapa, Mod. Martin .....          | 754      | Pinza para biopsia, Fauré .....                                 | 628              | Pinza para intestinos y tejidos, Thoms-Allis .....                 | 557           |
| Pinza gastro-intestinales gemelas, Lane .....       | 568-569  | Pinza para biopsia, Gellhorn .....                              | 628              | Pinza para intestinos y tejidos, Williams .....                    | 558           |
| Pinza gubia .....                                   | 524      | Pinza para biopsia, Kevorkian .....                             | 631              | Pinza para introducir, Fuller .....                                | 658           |
| Pinza gubia, Beyer .....                            | 525      | Pinza para biopsia, Schubert .....                              | 628-629          | Pinza para pasar tendones .....                                    | 509           |
| Pinza gubia, Blumenthal .....                       | 524      | Pinza para biopsia, Schumacher .....                            | 631-632          | Pinza para pasar tendones, Brand .....                             | 509           |
| Pinza gubia, Böhrler .....                          | 525      | Pinza para biopsia, Thoms-Gaylor .....                          | 629              | Pinza para pedículo renal, Guyon .....                             | 199-200       |
| Pinza gubia, Cleveland .....                        | 522      | Pinza para biopsia, Van Doren .....                             | 630              | Pinza para peritoneo, Faure .....                                  | 210           |
| Pinza gubia, Echlin .....                           | 527      | Pinza para biopsia, Gellhorn .....                              | 628              | Pinza para peritoneo, Mikulicz .....                               | 209-210       |
| Pinza gubia, Friedmann .....                        | 522      | Pinza para cálculos biliares, Blake .....                       | 586              | Pinza para peritoneo, Mikulicz-Baby .....                          | 209           |
| Pinza gubia, Frykholm .....                         | 528      | Pinza para cálculos biliares, Desjardins .....                  | 587              | Pinza para piel, Cottle .....                                      | 719           |
| Pinza gubia, Hartmann .....                         | 523      | Pinza para cálculos biliares, Mayo-Blake .....                  | 586              | Pinza para piel, Ogura .....                                       | 719           |
| Pinza gubia, Jansen .....                           | 523      | Pinza para cálculos biliares, Mixer .....                       | 587              | Pinza para plegar alambre, McGee .....                             | 656           |
| Pinza gubia, Leksell-Stille .....                   | 528      | Pinza para cálculos renales, Heiming .....                      | 584              | Pinza para pólipos auriculares, Hartmann .....                     | 672-673       |
| Pinza gubia, Lempert .....                          | 523      | Pinza para cálculos renales, Randall .....                      | 584              | Pinza para pólipos auriculares,<br>Hartmann-Herzfeld .....         | 673           |
| Pinza gubia, Luer .....                             | 525      | Pinza para cartílago, Bircher-Ganske .....                      | 511              | Pinza para pólipos auriculares,<br>Hartmann-Hoffmann .....         | 673           |
| Pinza gubia, Marquard .....                         | 526      | Pinza para cartílago, Dingmann .....                            | 511              | Pinza para pólipos auriculares,<br>Hartmann-Wulstein .....         | 673           |
| Pinza gubia, Mayfield .....                         | 526      | Pinza para cartílago, Martin .....                              | 512              | Pinza para pólipos auriculares, Strümpel .....                     | 673           |
| Pinza gubia, Mead .....                             | 523      | Pinza para catéteres, Magill .....                              | 388              | Pinza para pólipos nasales, Hartmann .....                         | 686           |
| Pinza gubia, Ruskin .....                           | 526      | Pinza para cerrar grapas, De Martel-Wolfson .....               | 566              | Pinza para pólipos uterinos, Keywood-Smith .....                   | 623           |
| Pinza gubia, Semb .....                             | 526      | Pinza para coger DIU .....                                      | 632              | Pinza para pólipos uterinos, Kelly .....                           | 623           |
| Pinza gubia, Stellbrink .....                       | 522      | Pinza para coger el bocio, Lahey .....                          | 550              | Pinza para pólipos uterinos, Noto .....                            | 623           |
| Pinza gubia, Stille .....                           | 526      | Pinza para coger órganos, Scheibe .....                         | 570              | Pinza para preparación y ligadura, Adson .....                     | 177           |
| Pinza gubia, Stille-Luer .....                      | 529      | Pinza para coger tendones, Carroll .....                        | 509              | Pinza para preparación y ligadura, Adson-Baby .....                | 186           |
| Pinza gubia, Stille-Ruskin .....                    | 527      | Pinza para coger tendones, Kleinert-Kutz .....                  | 510              | Pinza para preparación y ligadura, Adson .....                     | 170           |
| Pinza gubia, Zaufal-Jansen .....                    | 525      | Pinza para coger tendones, Steinmann .....                      | 509              | Pinza para preparación y ligadura, Crafoord .....                  | 188           |
| Pinza hemostática, Bengolea .....                   | 180      | Pinza para columna, Cottle .....                                | 719              | Pinza para preparación y ligadura, Finochietto .....               | 198           |
| Pinza hemostática, Chaput .....                     | 168      | Pinza para conducto biliar, Desjardins .....                    | 201              | Pinza para preparación y ligadura, Gemini .....                    | 192           |
| Pinza hemostática, Crile .....                      | 175      | Pinza para conducto biliar, Lahey .....                         | 745              | Pinza para preparación y ligadura, Heiss .....                     | 186           |
| Pinza hemostática, Crile-Rankin .....               | 176      | Pinza para cortar uñas .....                                    | 744              | Pinza para preparación y ligadura, Kelly .....                     | 202           |
| Pinza hemostática, Dandy .....                      | 176      | Pinza para cuello uterino .....                                 | 622              | Pinza para preparación y ligadura, Lawrence .....                  | 203           |
| Pinza hemostática, Dandy-Mosquito .....             | 176      | Pinza para cuello uterino, Braun .....                          | 619, 622         | Pinza para preparación y ligadura, Lower .....                     | 198           |
| Pinza hemostática, Dunhill .....                    | 174      | Pinza para cuello uterino, Czerny .....                         | 622              | Pinza para preparación y ligadura,<br>Martin-Fuchs .....           | 177           |
| Pinza hemostática, Halsted-Mosquito .....           | 171-172  | Pinza para cuello uterino, Duplay .....                         | 619              | Pinza para preparación y ligadura,<br>McQuigg-Mixer .....          | 197           |
| Pinza hemostática, Hartmann .....                   | 171      | Pinza para cuello uterino, Iowa .....                           | 621              | Pinza para preparación y ligadura, Meeker .....                    | 203           |
| Pinza hemostática, Kelly .....                      | 174      | Pinza para cuello uterino, Jacobs .....                         | 621              | Pinza para preparación y ligadura, Mikro-Adson .....               | 170           |
| Pinza hemostática, Kelly-Rankin .....               | 175      | Pinza para cuello uterino, Museux .....                         | 621              | Pinza para preparación y ligadura, Mini-Gemini .....               | 192           |
| Pinza hemostática, Kocher .....                     | 179      | Pinza para cuello uterino, Schröder .....                       | 619-620          | Pinza para preparación y ligadura, Mixer .....                     | 195-197       |
| Pinza hemostática, Kocher (Ochsner) .....           | 183-184  | Pinza para cuello uterino, Skene .....                          | 620              | Pinza para preparación y ligadura,<br>Mixer-Baby .....             | 170, 186, 194 |
| Pinza hemostática, Kocher-Nippon .....              | 179      | Pinza para cuello uterino, Seale .....                          | 620              | Pinza para preparación y ligadura,<br>Mixer .....                  | 195-197       |
| Pinza hemostática, Leriche .....                    | 173      | Pinza para cuerpos extraños, Mathieu .....                      | 597              | Pinza para preparación y ligadura,<br>Mixer-Baby .....             | 170, 186, 194 |
| Pinza hemostática, Lovelace .....                   | 176      | Pinza para desechos, Martin .....                               | 768              | Pinza para preparación y ligadura,<br>O'Shaughnessy .....          | 195           |
| Pinza hemostática, Mikro-Mosquito .....             | 173      | Pinza para desechos, Sauerbruch .....                           | 768              | Pinza para preparación y ligadura, Overholt .....                  | 191           |
| Pinza hemostática, Negus .....                      | 203      | Pinza para enderezar el tabique nasal, Asch .....               | 718              | Pinza para preparación y ligadura,<br>Overholt-Baby .....          | 175           |
| Pinza hemostática, Pean .....                       | 167, 178 | Pinza para enderezar el tabique nasal,<br>Cottle-Walsham .....  | 718              | Pinza para preparación y ligadura, Overholt-Fino .....             | 190           |
| Pinza hemostática, Pean (Rochester) .....           | 181-182  | Pinza para entrelazar tendones .....                            | 510              | Pinza para preparación y ligadura,<br>Overholt-Geissendörfer ..... | 189           |
| Pinza hemostática, Pean-Nippon .....                | 178      | Pinza para espinas .....  | 153-154          | Pinza para preparación y ligadura,<br>Overholt-Martin .....        | 185           |
| Pinza hemostática, Pennington .....                 | 169      | Pinza para espinas, Felchenfeld .....                           | 154              | Pinza para preparación y ligadura,<br>Overholt-Mini .....          | 191           |
| Pinza hemostática, Providence-Hospital .....        | 173      | Pinza para espinas, Hunter .....                                | 154              |  |               |
| Pinza hemostática, Rochester-Carmalt .....          | 177      | Pinza para espinas, Peet .....                                  | 156              |  |               |
| Pinza hemostática, Spencer-Wells .....              | 167      | Pinza para espinas, Stieglitz .....                             | 156              |  |               |
| Pinza hemostática, Tuffier .....                    | 168      | Pinza para esterilización .....                                 | 750              |  |               |
| Pinza intercambiable, Brünings .....                | 732-733  | Pinza para esterilización, Cheattle .....                       | 750              |  |               |
| Pinza intercambiable, Cordes .....                  | 733      |   |                  |  |               |
| Pinza intercambiable, Fraenkel .....                | 732      |   |                  |  |               |
| Pinza intercambiable, Krause .....                  | 733      |   |                  |  |               |
| Pinza intercambiable, Lange .....                   | 733      |   |                  |  |               |

Pinza para preparación y ligadura, Overholt-Mixer.....186  
 Pinza para preparación y ligadura, Roberts .....187  
 Pinza para preparación y ligadura, Rumel .....193  
 Pinza para preparación y ligadura, Sarot .....187  
 Pinza para preparación y ligadura, Schnidt .....177  
 Pinza para preparación y ligadura, Wikstroem .....196  
 Pinza para preparación y ligadura, Zenker.....194  
 Pinza para reposición .....512, 514  
 Pinza para romper yeso, Wolff.....449  
 Pinza para sacar órganos.....168  
 Pinza para sacar órganos, Collin .....169  
 Pinza para sacar órganos, Collin .....169  
 Pinza para tabique nasal .....670  
 Pinza para tabique nasal .....687  
 Pinza para tabique nasal, Brünings.....687  
 Pinza para tabique nasal, Lubet-Barbon .....694  
 Pinza para tabique nasal, Graig.....687  
 Pinza para tabique nasal, Knight.....687  
 Pinza para tabique nasal, Kressner .....718  
 Pinza para tabique nasal, Middleton-Jansen .....694  
 Pinza para taponamiento, Grünwald (Jansen) .....686  
 Pinza para taponamiento, Lubet-Barbon .....686  
 Pinza para taponamiento, Tröltzsch.....686  
 Pinza para taponamiento, Westmacott .....686  
 Pinza para tapones, Bergmann .....222  
 Pinza para tapones, Bozemann.....221  
 Pinza para tapones, Förster .....222-223  
 Pinza para tapones, Rampley.....223  
 Pinza para tapones, Ulrich.....218  
 Pinza para tubos .....213-214  
 Pinza para tubos, Hepp-Scheidel.....147  
 Pinza para tunelar .....220  
 Pinza para vendajes, Bryant.....219  
 Pinza para vendajes, Cheron.....221  
 Pinza para vendajes, Collin .....221  
 Pinza para vendajes, Gross-Maier .....220  
 Pinza para vendajes, Lister .....219  
 Pinza para vendajes, Martin .....219  
 Pinza sacabocado para esfenoid, Ferris-Smith-Kerrison.....697  
 Pinza sacabocado para esfenoid, Hajek .....696  
 Pinza sacabocado para maxilar .....692  
 Pinza sacabocado para maxilar, Kerrison .....698  
 Pinza tangencial, Uro-Tangential.....199  
 Pinza uterina para hemostasis, Green-Armytage ..640  
 Pinza vaginal, Wertheim-Cullen.....205  
 Pinzas para ligaduras, Ochsner.....438  
 Piper, Forceps obstétricos .....639  
 Pistola-lavatoria de chorro de agua, Martin aquajet .....762  
 Placa para extender la piel, Schink .....14  
 Plaquita de silicona .....753  
 Plester, Cánula de aspiración.....383  
 Plester, Cuchillo para lóbulos .....659  
 Plester, Separador autoestático .....290  
 Pluma, Low-Profile .....302  
 Polipótomo, Krause.....670, 684  
 Polipótomo, Krause-Voss.....670, 684  
 Politzer, Aguja para tímpano .....678  
 Poole, Tubo de aspiración .....373  
 Poppen, Tubo de aspiración.....367  
 Porta-agujas, Adson .....410  
 Porta-agujas, Bozemann.....425  
 Porta-agujas, Brown .....410  
 Porta-agujas, Collier .....409  
 Porta-agujas, Crile .....414  
 Porta-agujas, Crile-Murray .....410  
 Porta-agujas, Crile-Wood.....410, 415, 420  
 Porta-agujas, DeBakey .....422  
 Porta-agujas, Derf.....409, 419  
 Porta-agujas, Finocchio .....412, 423  
 Porta-agujas, Foster-Gillies .....428  
 Porta-agujas, Gillies .....414, 428  
 Porta-agujas, Gillies-Mini .....428  
 Porta-agujas, Halsey .....409, 420  
 Porta-agujas, Heaney .....411, 422  
 Porta-agujas, Hegar.....425  
 Porta-agujas, Hegar-Baumgartner .....410, 420  
 Porta-agujas, Hegar-Vascular.....425  
 Porta-agujas, Jameson .....412  
 Porta-agujas, Johnson .....413  
 Porta-agujas, Kilner .....419  
 Porta-agujas, Kübler .....430  
 Porta-agujas, Langenbeck .....430  
 Porta-agujas, M. G. Hospital.....411  
 Porta-agujas, Martin .....423  
 Porta-agujas, Martini.....426-427

Porta-agujas, Masson .....412, 422  
 Porta-agujas, Mathieu .....414, 428-429  
 Porta-agujas, Mayo-Hegar .....411, 421  
 Porta-agujas, Metzenbaum .....410  
 Porta-agujas, Microvascular.....426  
 Porta-agujas, Neivert .....409  
 Porta-agujas, Olsen Hegar .....414, 427  
 Porta-agujas, Par-Style .....416  
 Porta-agujas, Ryder (Martin).....423  
 Porta-agujas, Ryder-Vascular .....424  
 Porta-agujas, Sarot .....421  
 Porta-agujas, Stratte.....413, 426  
 Porta-agujas, Toennis .....429  
 Porta-agujas, Wangenstein .....413, 424  
 Porta-agujas, Webster .....409, 415, 419  
 Porta-algodón, Farrell .....355  
 Porta-clamp, De Martel-Wolfson .....567  
 Porta-hoja / Rompe-hoja de afeitar.....4  
 Porta-hoja / Rompe-hoja de afeitar, Castroviejo .....4  
 Porta-hoja / Rompe-hoja de afeitar, Troutman-Chris.....4  
 Porta-ligadura, Modell Wien.....438  
 Potts-Smith, Pinza de disección .....130, 133  
 Potts-Smith, Pinza de disección con diente.....142  
 Potts-Smith, Tijera vascular .....74-75  
 Pratt, Espéculo rectal .....579  
 Providence-Hospital, Pinza hemostática .....173  
 Punta de succión, Coupland .....378  
 Punta de succión, Wullstein .....368  
 Punta de succión, Zoellner .....368  
 Punta plástica, Nabatoff .....353  
 Punta suelta, Schumacher.....632  
 Punzón metálico .....474  
 Punzón metálico, Caspar .....474  
 Putti, Escofina para hueso .....473

**Q**  
 Quattro, Separador para yeso .....448  
 Quervain, Elevador .....501

**R**  
 Ragnell-Davis, Ganchito .....231  
 Ragnell, Tijera de disección .....123  
 Rampley, Pinza para tapones .....223  
 Randall, Pinza para cálculos renales .....584  
 Rasse, Gancho para huesos .....226  
 Rasse, Micro Ganchito .....226  
 Recamier, Cureta uterina.....634  
 Redon, Aguja de guía .....379-380  
 Rees, Tijera para Face-lift .....119  
 Resano, Pinza de disección con diente .....147  
 Resano, Pinza para anastomosis rectales.....578  
 Retractor para amputación, Percy .....521  
 Reynolds, Tijera de disección .....67-68  
 Ricard, Bastidor, suelto.....307  
 Ricard, Separador abdominal .....307  
 Ricard, Valva central .....307  
 Richardson-Eastman, Separador .....252  
 Richardson, marTract .....342  
 Richardson, Separador .....253  
 Richter, Pinza aplicadora para agrafes .....440  
 Riñonera .....760  
 Ritter-Halle, Dilatador para el seno maxilar .....720  
 Roberts, Pinza para preparación y ligadura .....187  
 Rochester-Carmalt, Pinza hemostática .....177  
 Roeder, Pinza de campo .....212  
 Roger, Elevador para tabique nasal .....704  
 Rogers, Pinza para histerectomía.....206  
 Rose, Gancho traqueal .....549  
 Rosen, Cuchillo para cortes redondos .....659  
 Rosen, Micro Aguja auricular .....660  
 Rosen, Micro Legra auricular .....662  
 Ross, Separador para aorta .....265  
 Roux-Baby, Separador .....277  
 Roux-Mini, Separador .....277  
 Roux, marTract.....344  
 Roux, Separador.....276  
 Rubin, Caperuza protectora .....695  
 Rubin, Osteótomo.....707  
 Rubin, Pinza para aplastamiento .....695  
 Rumel, Pinza para preparación y ligadura .....193  
 Ruskin-Liston, Pinza cortante para hueso.....532  
 Ruskin, Pinza gubia .....526  
 Russ, Modell, Pinza de disección con diente .....145  
 Rydel-Seiffert, Diapasón .....669  
 Rydel-Seiffert, Pesas .....669  
 Rydel-Seiffert, Sordina .....669  
 Rydel-Seiffert, Tornillo moleteado .....669  
 Ryder (Martin), Porta-agujas .....423  
 Ryder-Vascular, Porta-agujas .....424

**S**

Salyer, Disecador para el paladar.....726  
 Salyer, Elevador para el paladar .....726  
 Salyer, Ganchito para el paladar .....726  
 Salyer, Tijera de disección .....59, 107  
 Salyer, Tijera para Face-lift.....107  
 Sängner, Pinza para aborto .....640  
 Sanvenero, Tijera quirúrgica .....59  
 Sarot, Pinza para preparación y ligadura .....187  
 Sarot, Porta-agujas .....421  
 Satinsky, Tijera vascular .....71  
 Sauerbruch, Estuche para agujas .....751  
 Sauerbruch, Pinza para desechos.....768  
 Sauerbruch, Separador .....264  
 Scalp-Contour, Separador autoestático.....282  
 Schädel, Pinza de campo .....211  
 Schede, Cucharilla cortante .....482  
 Scheibe, Pinza para coger órganos .....570  
 Scherbak, Espéculo vaginal .....610  
 Scherbak, Mango para espéculo vaginal .....609, 610  
 Scherbak, Peso para espéculo vaginal .....610  
 Scherbak, Valva vaginal, suelta .....609  
 Schink, Dermatomo.....14  
 Schink, Hoja de repuesto.....14  
 Schink, Placa para extender la piel .....14  
 Schmid, Cánula para irrigación vascular .....384  
 Schmieden-Dick, Aguja para ligadura .....431  
 Schmieden-Payr, Sonda conductora .....436  
 Schmieden-Taylor, Tijera vascular .....77  
 Schmieden, Aguja para ligadura .....431  
 Schmieden, Sonda conductora.....436  
 Schnidt, Pinza para amígdalas .....729  
 Schnidt, Pinza para preparación y ligadura .....177  
 Schröder, Cucharilla uterina .....633  
 Schröder, Pinza para cuello uterino .....619-620  
 Schubert, Pinza para biopsia .....628-629  
 Schuhmacher, Tijera umbilical.....90  
 Schuknecht, Cuchillo de hoz .....659  
 Schumacher, Pinza para biopsia .....632  
 Schumacher, Punta suelta.....632  
 Schweden-Modell, Pinza de disección .....128  
 Scoville-Haverfield, Separador para laminectomía.....320  
 Scoville, Cucharilla cortante .....484  
 Scoville, Separador para laminectomía .....320  
 Scoville, Valva.....321  
 Scoville, Valva.....321  
 Scudder, Cuchillo para fibroma .....624  
 Seiffert, Pinza intercambiable .....732  
 Sellheim, Elevador obstétrico.....640  
 Semb, Perióstotomo .....496  
 Semb, Pinza gubia.....526  
 Semb, Pinza para huesos .....515  
 Semken, Pinza de disección .....129  
 Semken, Pinza de disección con diente.....131, 140  
 Semm, Espéculo vaginal .....601  
 Senn-Green, Ganchito .....231  
 Senn-Miller, Ganchito .....231  
 Separador .....238  
 Separador abdominal, Balfour .....312-313  
 Separador abdominal, Balfour-Baby .....311  
 Separador abdominal, Balfour-Standard .....314  
 Separador abdominal, Balfour, Mod. USA .....315  
 Separador abdominal, Collin .....304-306  
 Separador abdominal, Collin, Baby.....304, 307, 308  
 Separador abdominal, Gosset.....310-311  
 Separador abdominal, Gosset-Baby .....310  
 Separador abdominal, Kirschner .....317-318  
 Separador abdominal, O'Sullivan-O'Connor .....316  
 Separador abdominal, Ricard .....307  
 Separador autoestático .....280, 286-287, 302  
 Separador autoestático, Adson .....285, 294-295, 298  
 Separador autoestático, Alm .....281  
 Separador autoestático, Anderson-Adson .....282  
 Separador autoestático, Beckman-Adson .....299-300  
 Separador autoestático, Beckmann .....298  
 Separador autoestático, Cloward .....296-297  
 Separador autoestático, Finsen .....280  
 Separador autoestático, Finsen-Martin .....280  
 Separador autoestático, Gelpi .....303  
 Separador autoestático, Henley .....293  
 Separador autoestático, Jansen .....281  
 Separador autoestático, Low-Profile.....302  
 Separador autoestático, Martin .....301  
 Separador autoestático, Milligan .....292  
 Separador autoestático, Mollison .....289



|   |                    |   |            |   |                 |
|---|--------------------|---|------------|---|-----------------|
| Separador autoestático, Norfolk-Norwich.....          | 283                | Sims-Siebold, Tijera para ginecología.....              | 35         | Tijera de disección, Kilner.....                  | 65              |
| Separador autoestático, Plester.....                  | 290                | Sims, Cureta uterina.....                               | 634        | Tijera de disección, Knapp.....                   | 114             |
| Separador autoestático, Scalp-Contour.....            | 282                | Sims, Espéculo rectal.....                              | 579        | Tijera de disección, Kübler.....                  | 44              |
| Separador autoestático, Travers.....                  | 283                | Sims, Espéculo vaginal.....                             | 602        | Tijera de disección, Lexer.....                   | 46-48, 51, 115  |
| Separador autoestático, Weitlaner.....                | 284, 287-288       | Sims, Histerómetro.....                                 | 618        | Tijera de disección, Lexer-Baby.....              | 51              |
| Separador autoestático, Weitlaner-Baby.....           | 292                | Sims, Tijera para ginecología.....                      | 30-31      | Tijera de disección, Mayo-Harrington.....         | 29              |
| Separador autoestático, Weitlaner-Wullstein.....      | 289                | Singley-Tuttle, Pinza de disección con diente.....      | 146        | Tijera de disección, Mayo-Lexer.....              | 116             |
| Separador autoestático, Williams.....                 | 291                | Sistema Brazo Martin, Martin.....                       | 322        | Tijera de disección, Mayo-Noble.....              | 29              |
| Separador en forma de silla, Cottle.....              | 717                | Sistema de Retractores, Martin-Rochard.....             | 323        | Tijera de disección, Mayo-Stille.....             | 26-28           |
| Separador espinal, Taylor.....                        | 507                | Skene, Pinza para cuello uterino.....                   | 620        | Tijera de disección, Metzenbaum.....              | 37-44           |
| Separador nasal, Aufricht.....                        | 715, 717           | Smith-Petersen, Osteótomo.....                          | 469        | Tijera de disección, Metzenbaum-Nelson.....       | 40              |
| Separador nasal, Converse.....                        | 716                | Somer, Histerolabo.....                                 | 625        | Tijera de disección, Metzenbaum-Thorek.....       | 115             |
| Separador nasal, Cottle.....                          | 717                | Sonda abotonada.....                                    | 350        | Tijera de disección, Olivecrona.....              | 79              |
| Separador para aorta, Borowski.....                   | 266                | Sonda abotonada, Stacke.....                            | 350        | Tijera de disección, Ragnell.....                 | 123             |
| Separador para aorta, Ross.....                       | 265                | Sonda acanalada.....                                    | 351        | Tijera de disección, Reynolds.....                | 67-68           |
| Separador para atrio, Cooley.....                     | 271                | Sonda acanalada, Doyen.....                             | 351        | Tijera de disección, Salyer.....                  | 59, 107         |
| Separador para escápula, Davidson.....                | 261                | Sonda acanalada, Nelaton.....                           | 351        | Tijera de disección, Shea Vein Graft.....         | 64              |
| Separador para laminectomía, Scoville.....            | 320                | Sonda auricular, Hartmann.....                          | 670        | Tijera de disección, Thorek.....                  | 50              |
| Separador para laminectomía, Scoville-Haverfield..... | 320                | Sonda conductora de tendones, Bunnell.....              | 508        | Tijera fina de disección, Lexer-Fino.....         | 52              |
| Separador para pelvis, St. Marks.....                 | 274                | Sonda conductora, Brunner.....                          | 435        | Tijera fina de disección, Metzenbaum-Fino.....    | 53-58, 113, 117 |
| Separador para piloro, Benson.....                    | 567                | Sonda conductora, König.....                            | 437        | Tijera fina de disección, Metzenbaum-Lahey.....   | 117             |
| Separador para próstata, Young.....                   | 589                | Sonda conductora, Mod. Martin.....                      | 436        | Tijera fina de disección, Siegart.....            | 117             |
| Separador para rodilla, Blount.....                   | 507                | Sonda conductora, Payr.....                             | 438        | Tijera fina de disección, Toennis-Adson.....      | 78, 113         |
| Separador para rodilla, Blount.....                   | 507                | Sonda conductora, Schmieden.....                        | 436        | Tijera nasal, Cinelli.....                        | 50              |
| Separador para timo, Lukens.....                      | 549                | Sonda conductora, Schmieden-Payr.....                   | 436        | Tijera nasal, Converse.....                       | 88              |
| Separador para tiroides y vagina, Joll.....           | 303                | Sonda de mirto.....                                     | 350        | Tijera nasal, Cottle.....                         | 85              |
| Separador para yeso, Hennig.....                      | 448                | Sonda irrigadora para seno maxilar, Eicken-Killian..... | 720        | Tijera nasal, Fomon.....                          | 50, 83-84       |
| Separador para yeso, Quattro.....                     | 448                | Sonda metálica, femenina.....                           | 595        | Tijera nasal, Heymann.....                        | 86-87           |
| Separador rectal, Alan-Parks.....                     | 580                | Sonda para bocio, Kocher.....                           | 550        | Tijera para amígdalas, Dean.....                  | 80, 82          |
| Separador vesical, Judd-Masson.....                   | 592                | Sonda, Bowman.....                                      | 645        | Tijera para amígdalas, Good.....                  | 81              |
| Separador vesical, Millin.....                        | 593                | Soporte para espéculos auriculares.....                 | 665        | Tijera para cortar hilos de acero, Beebee.....    | 110             |
| Separador, Brunner.....                               | 262-263            | Soporte para ganchos, Martin-Rochard.....               | 323        | Tijera para cortar hilos de acero, Martin.....    | 124             |
| Separador, Collin-Hartmann.....                       | 276                | Sordina, Rydel-Seiffert.....                            | 669        | Tijera para cortar hilos de acero, Universal..... | 109             |
| Separador, Coryllos.....                              | 260                | Spencer-Wells, Pinza hemostática.....                   | 167        | Tijera para enucleación.....                      | 103             |
| Separador, Cushing.....                               | 231                | Spencer, Tijera para hilos.....                         | 108        | Tijera para episiotomía, Braun-Stadler.....       | 89              |
| Separador, Deaver.....                                | 268-270            | Spratt, Cucharilla cortante.....                        | 483        | Tijera para episiotomía, Waldmann.....            | 89              |
| Separador, Doyen.....                                 | 258                | St. Marks, marTract.....                                | 343        | Tijera para estrabismo.....                       | 103             |
| Separador, Doyen-Stille.....                          | 254                | St. Marks, Separador para pelvis.....                   | 274        | Tijera para estrabismo, Westcott.....             | 103             |
| Separador, Farabeuf.....                              | 277                | Stacke, Sonda abotonada.....                            | 350        | Tijera para Face-lift.....                        | 66              |
| Separador, Fritsch.....                               | 257                | Steinmann, Pinza para coger tendones.....               | 509        | Tijera para Face-lift, Aston.....                 | 45              |
| Separador, Goelet.....                                | 279                | Stellbrink, Pinza gubia.....                            | 522        | Tijera para Face-Lift, Gorney.....                | 45, 119         |
| Separador, Harrington.....                            | 267                | Stevens, Tijera para iridectomía.....                   | 101-102    | Tijera para Face-lift, Gorney-Freeman.....        | 118             |
| Separador, Hösel.....                                 | 255                | Stiegiltz, Pinza para espinas.....                      | 156        | Tijera para Face-Lift, Kaye.....                  | 44              |
| Separador, Israel.....                                | 242                | Stille-Barraya, Pinza de disección con diente.....      | 145        | Tijera para Face-lift, Peck-Joseph.....           | 62-63           |
| Separador, Kelly.....                                 | 253, 273           | Stille-Liston, Pinza cortante para hueso.....           | 532-533    | Tijera para Face-lift, Rees.....                  | 119             |
| Separador, Klapp.....                                 | 235                | Stille-Luer, Pinza gubia.....                           | 529        | Tijera para Face-lift, Salyer.....                | 107             |
| Separador, Kocher.....                                | 239, 247, 251, 258 | Stille-Martin, Cizalla para yeso.....                   | 445        | Tijera para ginecología.....                      | 120-121         |
| Separador, Kocher-Langenbeck.....                     | 248-249            | Stille-Martin, Hoja de recambio.....                    | 445        | Tijera para ginecología, Doyen.....               | 34              |
| Separador, Körte.....                                 | 241                | Stille-Ruskin, Pinza gubia.....                         | 527        | Tijera para ginecología, Sims.....                | 30-31           |
| Separador, Lahey.....                                 | 246                | Stille, Cincel.....                                     | 460        | Tijera para ginecología, Sims-Siebold.....        | 35              |
| Separador, Langenbeck.....                            | 243-245            | Stille, Gubia.....                                      | 461        | Tijera para ginecología, Wertheim.....            | 36              |
| Separador, Langenbeck-Green.....                      | 245                | Stille, Osteótomo.....                                  | 460-461    | Tijera para hilos, Buck.....                      | 108             |
| Separador, Little.....                                | 246                | Stille, Pinza de disección con diente.....              | 139        | Tijera para hilos, Eiselsberg.....                | 108             |
| Separador, Martin.....                                | 259                | Stille, Pinza gubia.....                                | 526        | Tijera para hilos, Littauer.....                  | 108             |
| Separador, Martin-Rochard.....                        | 323                | Stockmann, Clamp para pene.....                         | 598        | Tijera para hilos, Northbent.....                 | 107             |
| Separador, Mathieu.....                               | 279                | Strandell-Stille, Ganchito.....                         | 234        | Tijera para hilos, O'Brian.....                   | 107             |
| Separador, Middeldorpf.....                           | 252, 256           | Stratte, Porta-agujas.....                              | 413, 426   | Tijera para hilos, Spencer.....                   | 108             |
| Separador, Mikulicz.....                              | 273                | Strauss, Clamp para pene.....                           | 598        | Tijera para incisiones.....                       | 23              |
| Separador, Mikulicz.....                              | 272                | Strauss, par de mangueras individuales.....             | 598        | Tijera para intestino.....                        | 106             |
| Separador, Ollier.....                                | 240                | Strully, Tijera para neurocirugía.....                  | 77         | Tijera para iridectomía.....                      | 95-99           |
| Separador, Parker.....                                | 278                | Strümpel, Pinza para pólipos auriculares.....           | 673        | Tijera para iridectomía, Jabaley.....             | 100             |
| Separador, Parker-Langenbeck.....                     | 279                | Struycken, Pinza nasal cortante.....                    | 691        | Tijera para iridectomía, Mod. Bonn.....           | 96              |
| Separador, Parker-Mott.....                           | 278                | <b>T</b>  |            | Tijera para iridectomía, Stevens.....             | 101-102         |
| Separador, Richardson.....                            | 253                | Tabb, Cuchillo para mucosa.....                         | 659        | Tijera para ligaduras.....                        | 111-112         |
| Separador, Richardson-Eastman.....                    | 252                | Takahashi, Pinza para etmoides.....                     | 688        | Tijera para neurocirugía, Strully.....            | 77              |
| Separador, Roux.....                                  | 276                | Tamiz para espéculo vaginal, Weissbarth.....            | 612        | Tijera para uñas.....                             | 744             |
| Separador, Roux-Baby.....                             | 277                | Tapa de repuesto.....                                   | 478-479    | Tijera para vendajes.....                         | 442             |
| Separador, Roux-Mini.....                             | 277                | Tapa de repuesto, Mead.....                             | 477        | Tijera para vendajes, Lister.....                 | 442, 446        |
| Separador, Sauerbruch.....                            | 264                | Taponeador, Luniatshchek.....                           | 728        | Tijera para vendajes, Lorenz.....                 | 442             |
| Separador, Simon.....                                 | 259                | Tarro metálico.....                                     | 759        | Tijera para vendajes, Universal.....              | 444             |
| Separador, Volkmann.....                              | 236-238            | Tarro para instrumentos.....                            | 753        | Tijera para yeso, Bergmann.....                   | 443             |
| Separador, Wassmund.....                              | 241                | Taylor, Pinza de disección.....                         | 129        | Tijera para yeso, Bruns.....                      | 444, 446        |
| Separador, Zenker.....                                | 250                | Taylor, Pinza de disección con diente.....              | 141        | Tijera para yeso, Esmarch.....                    | 443             |
| Shambaugh, Micro Ganchito auricular.....              | 662                | Taylor, Separador espinal.....                          | 507        | Tijera quirúrgica.....                            | 16-23, 92       |
| Shapleigh, Cureta auricular.....                      | 676                | Teale, Pinza para cuello uterino.....                   | 620        | Tijera quirúrgica, Deaver.....                    | 23              |
| Shea Vein Graft, Tijera de disección.....             | 64                 | Thoms-Allis, Pinza para intestinos y tejidos.....       | 557        | Tijera quirúrgica, Goldman-Fox.....               | 91              |
| Shea, Ganchito explorador.....                        | 662                | Thoms-Gaylor, Pinza para biopsia.....                   | 629        | Tijera quirúrgica, Joseph.....                    | 60-61           |
| Siegart, Tijera fina de disección.....                | 117                | Thorek, Tijera de disección.....                        | 50         | Tijera quirúrgica, Kelly.....                     | 32-33           |
| Sierra nasal, Joseph.....                             | 709                | Tieck-Halle, Espéculo nasal.....                        | 681        | Tijera quirúrgica, Knapp.....                     | 22              |
| Sierra oscilante para yeso.....                       | 450                | Tijera acodada, De Bakey.....                           | 122        | Tijera quirúrgica, Mayo.....                      | 24-25           |
| Silver, Cincel nasal.....                             | 708                | Tijera coronaria, Dietrich-Potts.....                   | 73         | Tijera quirúrgica, Sanvenero.....                 | 59              |
| Silver, Dermatomo.....                                | 14                 | Tijera cuticular.....                                   | 745        | Tijera quirúrgica, Wagner.....                    | 92              |
| Silver, Hoja de repuesto.....                         | 14                 | Tijera de disección.....                                | 44, 59, 64 | Tijera umbilical, Busch.....                      | 90              |
| Simon, Cucharilla cortante.....                       | 484                | Tijera de disección, DeBakey.....                       | 49         | Tijera umbilical, Mod. USA.....                   | 90              |
| Simon, Cucharilla uterina.....                        | 633                | Tijera de disección, Diethrich-Salyer.....              | 72         | Tijera umbilical, Schuhmacher.....                | 90              |
| Simon, Gancho para fistulas.....                      | 626                | Tijera de disección, Hohenfellner.....                  | 49         | Tijera vascular.....                              | 71, 77          |
| Simon, Separador.....                                 | 259                | Tijera de disección, Jameson.....                       | 69         | Tijera vascular, De Bakey.....                    | 72              |
| Simpson, Forceps obstétricos.....                     | 638                |   |            | Tijera vascular, Diethrich.....                   | 72              |

|   |               |
|---|---------------|
| Tijera vascular, Dietrich-Hegemann .....                    | 74            |
| Tijera vascular, Dietrich-Potts .....                       | 73            |
| Tijera vascular, Favaloro .....                             | 77            |
| Tijera vascular, Potts-Smith .....                          | 74-75         |
| Tijera vascular, Satinsky .....                             | 71            |
| Tijera vascular, Schmieden-Taylor .....                     | 77            |
| Tijeras para encías .....                                   | 93-94         |
| Tijeras para encías, Goldman-Fox .....                      | 91            |
| Tijeras para encías, La Grange .....                        | 93            |
| Tijeras para encías, Locklin .....                          | 94            |
| Tira-miomas, Doyen .....                                    | 624           |
| Tobera, Martin aquajet .....                                | 762-763       |
| Toennis-Adson, Tijera fina de disección .....               | 78, 113       |
| Toennis, Porta-agujas .....                                 | 429           |
| Tohoku, Pinza de campo .....                                | 212           |
| Tornillo .....  | 508           |
| Tornillo de repuesto .....                                  | 462           |
| Tornillo moleteado, Rydel-Seiffert .....                    | 669           |
| Toynbee, Espéculo auricular .....                           | 664           |
| Travers, Separador autoestático .....                       | 283           |
| Tröltzsch (Wilde), Pinza auricular .....                    | 671           |
| Tröltzsch, Pinza para taponamiento .....                    | 686           |
| Trousseau, Dilatador traqueal .....                         | 548           |
| Troutman-Chris, Porta-hoja /<br>Rompe-hoja de afeitar ..... | 4             |
| Tubo de aspiración .....                                    | 362-363-376   |
| Tubo de aspiración, Adson .....                             | 364           |
| Tubo de aspiración, Baby-Poole .....                        | 373           |
| Tubo de aspiración, Baby-Yankauer .....                     | 371           |
| Tubo de aspiración, Baron-Schuknecht .....                  | 369           |
| Tubo de aspiración, Byrd .....                              | 378           |
| Tubo de aspiración, Cogswell .....                          | 378           |
| Tubo de aspiración, Cooley .....                            | 375           |
| Tubo de aspiración, De Bakey-Adson .....                    | 371           |
| Tubo de aspiración, Fergusson .....                         | 365-366       |
| Tubo de aspiración, Frazier .....                           | 364           |
| Tubo de aspiración, House .....                             | 374           |
| Tubo de aspiración, Jamieson .....                          | 377           |
| Tubo de aspiración, Landolt .....                           | 370           |
| Tubo de aspiración, Luer .....                              | 369           |
| Tubo de aspiración, Nuboer .....                            | 377           |
| Tubo de aspiración, Poole .....                             | 373           |
| Tubo de aspiración, Poppen .....                            | 367           |
| Tubo de aspiración, Wullstein .....                         | 368           |
| Tubo de aspiración, Yankauer .....                          | 371-372       |
| Tubo de aspiración, Yankauer .....                          | 372           |
| Tubo de aspiración, Yasargil .....                          | 370           |
| Tubo de aspiración, Zoellner .....                          | 368           |
| Tubo de extensión, Brünings .....                           | 632           |
| Tubo de laringeo, Brünings .....                            | 732           |
| Tuerca de mariposa, Alan-Parks .....                        | 580           |
| Tuerca moleteada .....                                      | 518           |
| Tuerca-hembra .....   | 763           |
| Tuffier, Pinza hemostática .....                            | 168           |
| Tuohy, Aguja para punción lumbar .....                      | 382           |
| Tyding, Cierra-nudo para amígdalas .....                    | 730           |
| <b>U</b>  |               |
| Ulrich, Pinza para huesos .....                             | 517           |
| Ulrich, Pinza para taponos .....                            | 218           |
| Universal, Tijera para cortar hilos de acero .....          | 109           |
| Universal, Tijera para vendajes .....                       | 444           |
| Uro-Tangential, Pinza tangencial .....                      | 199           |
| <b>V</b>  |               |
| Valleix, Histerómetro .....                                 | 618           |
| Valva central, Alan-Parks .....                             | 580           |
| Valva central, Balfour .....                                | 313           |
| Valva central, Balfour-Standard .....                       | 312, 314-315  |
| Valva central, Collin .....                                 | 305-306       |
| Valva central, Gosset .....                                 | 310           |
| Valva central, Henley .....                                 | 293           |
| Valva central, Low-Profile .....                            | 302           |
| Valva central, Millin .....                                 | 593           |
| Valva central, O'Sullivan-O'Connor .....                    | 316           |
| Valva central, Ricard .....                                 | 307           |
| Valva de alambre, Balfour, Mod. USA .....                   | 315           |
| Valva lateral .....   | 304-309       |
| Valva lateral, Alan-Parks .....                             | 580           |
| Valva lateral, Millin .....                                 | 593           |
| Valva vaginal, Doyen .....                                  | 612           |
| Valva vaginal, Kallmorgen .....                             | 607           |
| Valva vaginal, Kristeller .....                             | 603-606       |
| Valva vaginal, suelta, Scherbak .....                       | 609           |
| Valva, Cloward .....  | 296-297       |
| Valva, Kirschner .....                                      | 317-319       |
| Valva, Scoville .....                                       | 321           |
| Valva, Scoville .....                                       | 321           |
| Válvula de aspiración, Cerullo .....                        | 370           |
| Van Buren, Bujía uretral .....                              | 594           |
| Van Doren, Pinza para biopsia .....                         | 630           |
| Varady, Flebextractor .....                                 | 352           |
| Varady, Flebodisecador .....                                | 352           |
| Varady, Micro Disecador .....                               | 352           |
| Varady, Micro Fleboextractor .....                          | 352           |
| Varady, Mini Flebextractor .....                            | 352           |
| Vaso-medida .....   | 757           |
| Veidenheimer, Pinza para<br>anastomosis rectales .....      | 577           |
| Verbrugge, Pinza para huesos .....                          | 520-521       |
| Vidrio de repuesto .....                                    | 743           |
| Virchow, Cuchillos .....                                    | 3             |
| Volkman, Cucharilla cortante .....                          | 481-482       |
| Volkman, Cucharilla de doble extremo .....                  | 486           |
| Volkman, marTract .....                                     | 344           |
| Volkman, Separador .....                                    | 236-238       |
| Vollmar, Fleboextractor .....                               | 354           |
| <b>W</b>  |               |
| Wachenfeldt, Pinza aplicadora para agrafes .....            | 439           |
| Wagener, Ganchito auricular .....                           | 678           |
| Wagner, Tijera quirúrgica .....                             | 92            |
| Waldmann, Tijera para episiotomía .....                     | 89            |
| Walter, Gubia .....   | 707           |
| Walter, Osteótomo .....                                     | 707           |
| Wangensteen, Pinza de disección .....                       | 134           |
| Wangensteen, Porta-agujas .....                             | 413, 424      |
| Wassmund, Separador .....                                   | 241           |
| Watson-Williams, Pinza para etmoides .....                  | 689           |
| Waugh, Pinza de disección .....                             | 128           |
| Waugh, Pinza de disección con diente .....                  | 140           |
| Weber-Loch, Instrumento para<br>cuerpos extraños .....      | 677           |
| Webster, Porta-agujas .....                                 | 409, 415, 419 |
| Weil-Blakesley, Pinza nasal cortante .....                  | 690           |
| Weil-Blakesley, Pinza para etmoides .....                   | 690           |
| Weil, Pinza nasal cortante .....                            | 689           |
| Weissbarth, Espéculo vaginal .....                          | 612           |
| Weissbarth, Tamiz para espéculo vaginal .....               | 612           |
| Weitlaner-Baby, Separador autoestático .....                | 292           |
| Weitlaner-Wullstein, Separador autoestático .....           | 289           |
| Weitlaner, Separador autoestático .....                     | 284, 287-288  |
| Wertheim-Cullen, Pinza vaginal .....                        | 205           |
| Wertheim, Pinza para histerectomía .....                    | 208           |
| Wertheim, Tijera para ginecología .....                     | 36            |
| Westcott, Tijera para estrabismo .....                      | 103           |
| Westmacott, Pinza para taponamiento .....                   | 686           |
| White, Pinza para amígdalas .....                           | 729           |
| Wikstroem, Pinza para preparación y ligadura .....          | 196           |
| Williams, Pinza para intestinos y tejidos .....             | 558           |
| Williams, Separador autoestático .....                      | 291           |
| Williger, Cucharilla de doble extremo .....                 | 487           |
| Williger, Elevador .....                                    | 501           |
| Williger, Martillo .....                                    | 475, 477      |
| Williger, Periostótomo .....                                | 494           |
| Winter, Pinza para aborto .....                             | 640           |
| Wolff, Pinza para romper yeso .....                         | 449           |
| Wrigley, Forceps obstétricos .....                          | 638           |
| Wullstein, Cuchillo de hoz .....                            | 659           |
| Wullstein, Micro Tijera auricular .....                     | 655           |
| Wullstein, Punta de succión .....                           | 368           |
| Wullstein, Tubo de aspiración .....                         | 368           |
| <b>Y</b>  |               |
| Yankauer, Cabezal para aspiración .....                     | 372           |
| Yankauer, Mango .....                                       | 372           |
| Yankauer, Oliva .....                                       | 372           |
| Yankauer, Tubo de aspiración .....                          | 371-372       |
| Yankauer, Tubo de aspiración .....                          | 372           |
| Yasargil, Tubo de aspiración .....                          | 370           |
| Young, Separador para próstata .....                        | 589           |
| <b>Z</b>  |               |
| Zaufal-Jansen, Pinza gubia .....                            | 525           |
| Zaufal, Elevador para cuerpos extraños .....                | 677           |
| Zenker, Pinza para preparación y ligadura .....             | 194           |
| Zenker, Separador .....                                     | 250           |
| Zielke, Gubia .....   | 459           |
| Zoellner, Punta de succión .....                            | 368           |
| Zoellner, Tubo de aspiración .....                          | 368           |

---

Index alphabétique  
**Français**





- Ciseaux à strabisme, Westcott .....103  
 Ciseaux chirurgicaux .....16-23, 92  
 Ciseaux chirurgicaux, Deaver .....23  
 Ciseaux chirurgicaux, Goldman-Fox .....91  
 Ciseaux chirurgicaux, Joseph .....60-61  
 Ciseaux chirurgicaux, Kelly .....32-33  
 Ciseaux chirurgicaux, Knapp .....22  
 Ciseaux chirurgicaux, Mayo .....24-25  
 Ciseaux chirurgicaux, Sanvenero .....59  
 Ciseaux chirurgicaux, Wagner .....92  
 Ciseaux coronaires, Dietrich-Potts .....73  
 Ciseaux coudés, De Bakey .....122  
 Ciseaux coupe-fil, Beebe .....110  
 Ciseaux coupe-fil, Martin .....124  
 Ciseaux coupe-fil, Universal .....109  
 Ciseaux fins à dissection, Lexer-Fino .....52  
 Ciseaux fins à dissection, Metzenbaum-Fino .....53-58, 113, 117  
 Ciseaux fins à dissection, Metzenbaum-Lahey .....117  
 Ciseaux fins à dissection, Siegert .....117  
 Ciseaux fins à dissection, Toennis-Adson .....78, 113  
 Ciseaux nasaux, Cinelli .....50  
 Ciseaux nasaux, Converse .....88  
 Ciseaux nasaux, Cottle .....85  
 Ciseaux nasaux, Fomon .....50, 83-84  
 Ciseaux nasaux, Heymann .....86-87  
 Ciseaux pour Face-lift .....66  
 Ciseaux pour Face-lift, Aston .....45  
 Ciseaux pour Face-lift, Gorney .....45, 119  
 Ciseaux pour Face-lift, Gorney-Freeman .....118  
 Ciseaux pour Face-lift, Kaye .....44  
 Ciseaux pour Face-lift, Peck-Joseph .....62-63  
 Ciseaux pour Face-lift, Rees .....119  
 Ciseaux pour Face-lift, Salyer .....107  
 Ciseaux pour le cordon ombilical, Busch .....90  
 Ciseaux pour le cordon ombilical, Mod. USA .....90  
 Ciseaux pour le cordon ombilical, Schuhmacher .....90  
 Ciseaux pour les amygdales, Dean .....80, 82  
 Ciseaux pour les amygdales, Good .....81  
 Ciseaux pour ligatures .....111-112  
 Ciseaux pour neurochirurgie, Strully .....77  
 Ciseaux pour pansements .....442  
 Ciseaux pour pansements, Lister .....442, 446  
 Ciseaux pour pansements, Lorenz .....442  
 Ciseaux pour pansements, Universal .....444  
 Ciseaux pour plâtre, Bergmann .....443  
 Ciseaux pour plâtre, Bruns .....444, 446  
 Ciseaux pour plâtre, Esmarch .....443  
 Ciseaux pour plâtre, Stille-Martin .....445  
 Ciseaux vasculaires .....71, 77  
 Ciseaux vasculaires, De Bakey .....72  
 Ciseaux vasculaires, Diethrich .....72  
 Ciseaux vasculaires, Dietrich-Hegemann .....74  
 Ciseaux vasculaires, Dietrich-Potts .....73  
 Ciseaux vasculaires, Favalaro .....77  
 Ciseaux vasculaires, Potts-Smith .....74-75  
 Ciseaux vasculaires, Satsinsky .....71  
 Ciseaux vasculaires, Schmieden-Taylor .....77  
 Ciseaux-burin pour spongiosa, Lexer .....463  
 Ciseaux-entérotomes .....106  
 Citelli, Pince pour polypes auriculaires .....674  
 Clamp ombilical, Collin .....642  
 Clamps Bulldog .....162  
 Clamps Bulldog, DeBakey-Diethrich .....164  
 Clamps Bulldog, Dieffenbach .....162  
 Clamps Bulldog, Diethrich .....164  
 Clamps Bulldog, Johns-Hopkins .....163  
 Clamps Bulldog, Mini-Glover .....165-166  
 Clé .....462  
 Clé pour approximateur .....160  
 Cleveland, Pincés coupantes à os .....531  
 Cleveland, Pincés-gouges .....522  
 Clip de stérilisation, Mayo .....754  
 Clip vasculaire, Biemer .....158  
 Cloward, Ecarteur autostatique .....296-297  
 Cloward, Valve .....296-297  
 Coakley, Curette pour l'antré .....719  
 Cobb, Gouge .....470  
 Cobb, Rugine-raspatoire .....492  
 Cogswell, Tube d'aspiration .....378  
 Collier, Porte-aiguilles .....409  
 Collin-Hartmann, Ecarteur .....276  
 Collin, Baby, Ecarteur abdominal .....304, 307-308  
 Collin, Clamp ombilical .....642  
 Collin, Ecarteur abdominal .....304-306  
 Collin, Maillet .....476  
 Collin, Manche pour bistouri .....6  
 Collin, Pince à pansements .....221  
 Collin, Pince à tumeurs à vis .....169  
 Collin, Pince hystérolabe .....625  
 Collin, Pince pour saisir organes .....169  
 Collin, Spéculum vaginal .....600  
 Collin, Valve centrale .....305-306  
 Combinaison couvercle/pince, Mod. Martin .....754  
 Compas, Castroviejo .....644  
 Compas, Castroviejo-Epker .....644  
 Converse, Ciseaux nasaux .....88  
 Converse, Couteau pour plastie du nez .....699  
 Converse, Crochet pour les ailes du nez .....716  
 Converse, Ecarteur nasal .....716  
 Cooley, Ecarteur pour atrium .....271  
 Cooley, Tube d'aspiration .....375  
 Cooper, Aiguilles à ligatures .....432  
 Cordes, Embout interchangeable .....733  
 Coryllos, Ecarteur .....260  
 Cottle-Kazanjian, Pincés coupantes à os .....530  
 Cottle-Neivert, Crochet pour les ailes du nez .....717  
 Cottle-Walsham, Pince pour le redressement de la cloison nasale .....718  
 Cottle, Ciseaux nasaux .....85  
 Cottle, Couteau pour plastie du nez .....699  
 Cottle, Crochet nasal .....715  
 Cottle, Crochet pour les ailes du nez .....717  
 Cottle, Ecarteur nasal .....717  
 Cottle, Elevateur pour la cloison nasale .....703-704  
 Cottle, Elevateur pour le périoste .....704  
 Cottle, Elevateur sous forme de selle .....717  
 Cottle, Maillet .....476  
 Cottle, Ostéotome .....706  
 Cottle, Pince à columella .....719  
 Cottle, Pince pour saisir la peau .....719  
 Cottle, Pince-gouge à cartilage .....710  
 Cottle, Râpe nasale .....711  
 Cottle, Rugine-raspatoire .....490  
 Cottle, Spéculum nasal .....682-683  
 Coupland, Manche pour tubes d'aspiration .....378  
 Coupland, Pointe de suction .....378  
 Couteau à amputation, Liston .....13  
 Couteau à résection .....13  
 Couteau circulaire, Rosen .....659  
 Couteau lobaire, Plester .....659  
 Couteau pour muqueuse, Freer .....700  
 Couteau pour muqueuse, Tabb .....659  
 Couteau pour plastie du nez, Converse .....699  
 Couteau pour plastie du nez, Cottle .....699  
 Couteau pour plastie du nez, Fomon .....699  
 Couteau pour plastie du nez, Joseph .....699  
 Couteau pour plâtre, Esmarch .....447  
 Couteau pour plâtre, Hopkins .....447  
 Couteau pour plâtre, Martin .....447  
 Couteaux à végétations adénoïdes, Beckmann .....720  
 Couteaux, Virchow .....3  
 Crafoord, Pince à disséquer et à ligatures .....188  
 Crile-Murray, Porte-aiguilles .....410  
 Crile-Rankin, Pince hémostatique .....176  
 Crile-Wood, Porte-aiguilles .....410, 415, 420  
 Crile, Pince hémostatique .....175  
 Crile, Porte-aiguilles .....414  
 Crochet .....227-228, 230, 235  
 Crochet à exploration, Shea .....662  
 Crochet auriculaire, Day .....678  
 Crochet auriculaire, Lucae .....677  
 Crochet auriculaire, Wagener .....678  
 Crochet nasal, Cottle .....715  
 Crochet nasal, Joseph .....715-716  
 Crochet pour fistules, Emmett .....626  
 Crochet pour fistules, Simon .....626  
 Crochet pour la muqueuse, Freer .....716  
 Crochet pour la peau .....226  
 Crochet pour la peau, Guthrie .....227  
 Crochet pour la peau, O'Connor .....227  
 Crochet pour les ailes du nez, Converse .....716  
 Crochet pour les ailes du nez, Cottle .....717  
 Crochet pour les ailes du nez, Cottle-Neivert .....717  
 Crochet pour les ailes du nez, Fomon .....715-716  
 Crochet pour les ailes du nez, Kilner .....716  
 Crochet pour les ailes du nez, Lange .....715  
 Crochet pour les ailes du nez, Neivert .....717  
 Crochet pour palais, Salyer .....726  
 Crochet, Cushing .....231  
 Crochet, Langenbeck-Mini .....229  
 Crochet, Meyerding .....230  
 Crochet, Ragnell-Davis .....231  
 Crochet, Senn-Green .....231  
 Crochet, Senn-Miller .....231  
 Crochet, Strandell-Stille .....234  
 Curette / crochet auriculaire, Weber-Loch .....677  
 Curette à aspiration, Novak .....627  
 Curette a avortement et placenta, Cuzzi .....641  
 Curette a avortement et placenta, Pestalozza .....642  
 Curette auriculaire, Buck .....676  
 Curette auriculaire, Gross .....677  
 Curette auriculaire, Jansen .....677  
 Curette auriculaire, Lempert .....679  
 Curette auriculaire, Shapleigh .....676  
 Curette double .....486  
 Curette double, Faulkner .....719  
 Curette double, Jacobson .....486  
 Curette double, Molt .....487  
 Curette double, Volkmann .....486  
 Curette double, Williger .....487  
 Curette pour biopsie, Kevorkian .....627  
 Curette pour biopsie, Mod. München .....627  
 Curette pour l'antré, Coakley .....719  
 Curette tranchante .....485  
 Curette tranchante, Bruns .....483-484  
 Curette tranchante, Daubenspeck .....482  
 Curette tranchante, Halle .....485  
 Curette tranchante, Modell USA .....485  
 Curette tranchante, Schede .....482  
 Curette tranchante, Scoville .....484  
 Curette tranchante, Simon .....484  
 Curette tranchante, Spratt .....483  
 Curette tranchante, Volkmann .....481-482  
 Curette utérine, Blake .....633  
 Curette utérine, Greene .....636  
 Curette utérine, Recamier .....634  
 Curette utérine, Schróder .....633  
 Curette utérine, Simon .....633  
 Curette utérine, Sims .....634  
 Curettes d'aspiration .....636  
 Curettes pour calculs biliaires, Luer-Körte .....588  
 Curseur, Rydel-Seiffert .....669  
 Nasco, Spéculum vaginal .....600  
 Cushing-Taylor, Pince à dissection .....133  
 Cushing, Crochet .....231  
 Cushing, Ecarteur sous forme de selle .....232  
 Cushing, Pince à dissection .....130, 133, 142  
 Cuvette en acier inoxydable .....757  
 Cuzzi, Curette a avortement et placenta .....641  
 Czerny, Pince pour le col de l'utérus .....622  
 Czerny, Spéculum rectal .....579
- D**  
 Dandy-Mosquito, Pince hémostatique .....176  
 Dandy, Pince hémostatique .....176  
 Dartigues, Pince hystérolabe .....625  
 Daubenspeck, Curette tranchante .....482  
 Davidson, Ecarteur pour scapula .....261  
 Davier porte-os .....514  
 Davier porte-os .....511, 518  
 Davier porte-os, Farabeuf .....516  
 Davier porte-os, Kern .....515  
 Davier porte-os, Lane .....519  
 Davier porte-os, Semb .....515  
 Davier porte-os, Ulrich .....517  
 Davier porte-os, Verbrugge .....520-521  
 Daviers porte-os .....512  
 Daviers porte-os, Fergusson .....513  
 Daviers porte-os, Frosch .....513  
 Daviers porte-os, Langenbeck .....513  
 Daviers porte-os, Lewin .....512  
 Day, Crochet auriculaire .....678  
 De Martel-Wolfson, Pince pour anastomoses intestinale .....566  
 De Martel-Wolfson, Pince pour fermer les clamps .....566  
 De Martel-Wolfson, Porte-clamps .....567  
 Dean, Ciseaux pour les amygdales .....80, 82  
 Deaver, Ciseaux chirurgicaux .....23  
 Deaver, Ecarteur .....268-270  
 Deaver, marTract .....337  
 DeBakey-Adson, Tube d'aspiration .....371  
 DeBakey-Diethrich, Clamps Bulldog .....164  
 DeBakey, Ciseaux à dissection .....49  
 DeBakey, Ciseaux coudés .....122  
 DeBakey, Ciseaux vasculaires .....72  
 DeBakey, Pince atraumatique à dissection .....135-136  
 DeBakey, Porte-aiguilles .....422  
 Dépresseur utérin, Braun .....618  
 Derf, Porte-aiguilles .....409, 419  
 Dermatome, Humby .....14  
 Dermatome, Schink .....14  
 Dermatome, Silver .....14  
 Deschamps, Aiguilles à ligatures .....433-434  
 Desjardins, Pince pour calculs biliaires .....587  
 Desjardins, Pince pour les voies biliaires .....201

|   |                   |   |                    |   |           |
|---|-------------------|---|--------------------|---|-----------|
| Desmarres, Ecarteur sous forme de selle .....       | 229               | Ecarteur nasal, Aufricht .....                        | 715, 717           | Elévateur pour le périoste, Joseph.....             | 704       |
| Diapason .....                                      | 669               | Ecarteur nasal, Converse .....                        | 716                | Elévateur pour le périoste, Joseph-Masing .....     | 704       |
| Diapason, French .....                              | 666               | Ecarteur nasal, Cottle .....                          | 717                | Elévateur pour le périoste, Masing .....            | 704       |
| Diapason, Hartmann .....                            | 666-668           | Ecarteur pour aorta, Borowski.....                    | 266                | Elévateur pour le périoste, Roger .....             | 704       |
| Diapason, König .....                               | 669               | Ecarteur pour aorta, Ross .....                       | 265                | Elévateur pour palais, Salyer .....                 | 726       |
| Diapason, Lucae .....                               | 668               | Ecarteur pour atrium, Coolley .....                   | 271                | Elévateur sous forme de selle, Cottle.....          | 717       |
| Diapason, Martin .....                              | 667               | Ecarteur pour laminectomie, Scoville .....            | 320                | Elévateur, Adson .....                              | 498       |
| Diapason, Martin-Alloy .....                        | 667               | Ecarteur pour laminectomie, Scoville-Haverfield ..... | 320                | Elévateur, Langenbeck .....                         | 500       |
| Diapason, Neuro .....                               | 669               | Ecarteur pour le col de la vessie, Millin.....        | 592                | Elévateur, Martin-Langenbeck .....                  | 500       |
| Diapason, Rydel-Seiffert .....                      | 669               | Ecarteur pour le thymus, Lukens.....                  | 549                | Elévateur, Quervain .....                           | 501       |
| Dieffenbach, Clamps Bulldog.....                    | 162               | Ecarteur pour pelvis, St. Marks.....                  | 274                | Elévateur, Sebileau .....                           | 501       |
| Diethrich-Salyer, Ciseaux à dissection.....         | 72                | Ecarteur pour pylore, Benson .....                    | 567                | Elévateur, Williger .....                           | 501       |
| Diethrich, Ciseaux vasculaires .....                | 72                | Ecarteur pour scapula, Davidson .....                 | 261                | Elévateurs pour amygdales, Henke .....              | 728       |
| Diethrich, Clamps Bulldog .....                     | 164               | Ecarteur pour thyroïde et vulva, Joll.....            | 303                | Embout de ringage, Martin aquajet .....             | 762-763   |
| Diethrich-Hegemann, Ciseaux vasculaires .....       | 74                | Ecarteur pour trachéotomie, Iterson.....              | 549                | Embout interchangeable, Brünings .....              | 732-733   |
| Dietrich-Potts, Ciseaux coronaires .....            | 73                | Ecarteur pour trachéotomie, Jackson.....              | 549                | Embout interchangeable, Cordes.....                 | 733       |
| Dietrich-Potts, Ciseaux vasculaires .....           | 73                | Ecarteur pour trachéotomie, Luer .....                | 549                | Embout interchangeable, Fraenkel .....              | 732       |
| Dilatateur du col de l'utérus, Hank .....           | 617               | Ecarteur pour trachéotomie, Rose.....                 | 549                | Embout interchangeable, Krause.....                 | 733       |
| Dilatateur du col de l'utérus, Hegar .....          | 614-616           | Ecarteur pour veines, Brom .....                      | 234                | Embout interchangeable, Lange .....                 | 733       |
| Dilatateur pour la trachéotomie, Laborde .....      | 548               | Ecarteur prostatiques, Young .....                    | 589                | Embout interchangeable, Seiffert.....               | 732       |
| Dilatateur pour la trachéotomie, Trouseau .....     | 548               | Ecarteur sous forme de selle, Cushing.....            | 232                | Embout interchangeable, Schumacher .....            | 632       |
| Dilatateur pour le sinus frontal, Ritter-Halle..... | 720               | Ecarteur sous forme de selle, Desmarres .....         | 229                | Emmett, Crochet pour fistules.....                  | 626       |
| Dilatateur pour les voies biliaires, Bakes.....     | 585               | Ecarteur sous forme de selle, Gil-Vernet .....        | 233                | Endospéculum, Kogan .....                           | 613       |
| Dilatateur rectal, Alan-Parks .....                 | 580               | Ecarteur vésical, Judd-Masson .....                   | 592                | Esmarch, Ciseaux pour plâtre .....                  | 443       |
| Dingmann, Pincés à cartilage .....                  | 511               | Ecarteur vésical, Millin .....                        | 593                | Esmarch, Couteau pour plâtre .....                  | 447       |
| Dissecteur double .....                             | 501               | Ecarteur, Brunner .....                               | 262-263            | Etau de maintien universel, Martin .....            | 322, 323  |
| Dissecteur double, Alderdyce .....                  | 501               | Ecarteur, Collin-Hartmann .....                       | 276                | Etau, Martin-Rochard .....                          | 323       |
| Dissecteur double, McDonald.....                    | 501               | Ecarteur, Coryllos .....                              | 260                | Eves, Serre-noeuds pour amygdales .....             | 730       |
| Dissecteur pour l'attique, Austin .....             | 662               | Ecarteur, Deaver .....                                | 268-270            | Evideur de fibromes, Segond .....                   | 624       |
| Dissecteur pour palais, Salyer .....                | 726               | Ecarteur, Doyen .....                                 | 258                | Extracteur pour phlébite micro, Varady .....        | 352       |
| Dissecteur pour phlébite, Varady .....              | 352               | Ecarteur, Doyen-Stille.....                           | 254                | Extracteur pour phlébite mini, Varady .....         | 352       |
| Dissecteur/Rétracteur pour amygdales, Hurd.....     | 727               | Ecarteur, Farabeuf.....                               | 277                | Extracteur pour phlébite, Varady .....              | 352       |
| Distributeurs de brosses, Martin .....              | 742-743           | Ecarteur, Fritsch .....                               | 257                |   |           |
| Dittel, Instrument d'insertion de cathéter.....     | 388               | Ecarteur, Goelet .....                                | 279                | <b>F</b>  |           |
| Douglas, Pince à épiler les cils .....              | 155               | Ecarteur, Harrington .....                            | 267                | Farabeuf-Collin, Rugine-raspatoire .....            | 491       |
| Doyen-Baby, Pince intestinale .....                 | 561, 571          | Ecarteur, Hösel .....                                 | 255                | Farabeuf, Davier porte-os .....                     | 516       |
| Doyen-Stille, Ecarteur.....                         | 254               | Ecarteur, Israël.....                                 | 242                | Farabeuf, Ecarteur.....                             | 277       |
| Doyen, Ciseaux à gynécologie .....                  | 34                | Ecarteur, Kelly .....                                 | 253, 273           | Farabeuf, Rugine-raspatoire .....                   | 491       |
| Doyen, Ecarteur .....                               | 258               | Ecarteur, Klapp .....                                 | 235                | Farrell, Porte-coton .....                          | 355       |
| Doyen, Maillet .....                                | 475               | Ecarteur, Kocher.....                                 | 239, 247, 251, 258 | Farrior, Spéculum auriculaire .....                 | 665       |
| Doyen, Pince intestinale .....                      | 560               | Ecarteur, Kocher-Langenbeck .....                     | 248-249            | Faulkner, Curette double .....                      | 719       |
| Doyen, Rugine pour le périoste costal .....         | 495               | Ecarteur, Körte .....                                 | 241                | Faure, Pince pour biopsie .....                     | 628       |
| Doyen, Sonde cannelée.....                          | 351               | Ecarteur, Lahey.....                                  | 246                | Faure, Pince pour le péritoine .....                | 210       |
| Doyen, Spéculum vaginal .....                       | 608               | Ecarteur, Langenbeck .....                            | 243-245            | Favaloro, Ciseaux vasculaires.....                  | 77        |
| Doyen, Tracteur pour myomes .....                   | 624               | Ecarteur, Langenbeck-Green .....                      | 245                | Fehland, Pince pour anastomose rectale.....         | 577       |
| Doyen, Valve vaginale .....                         | 612               | Ecarteur, Little .....                                | 246                | Feilchenfeld, Pince à écharde .....                 | 154       |
| Dunhill, Pince hémostatique .....                   | 174               | Ecarteur, Martin .....                                | 259                | Ferguson, Canules d'aspiration .....                | 365-366   |
| Duplay, Pince pour le col de l'utérus .....         | 619               | Ecarteur, Martin-Rochard .....                        | 323                | Ferguson, Daviers porte-os.....                     | 513       |
| Durante, Pince à dissection à griffes .....         | 145               | Ecarteur, Mathieu.....                                | 279                | Ferris-Smith-Kerrison, Pince emporte-pièces         |           |
| Duval, Pince pour saisir intestins et tissus.....   | 559-560           | Ecarteur, Middeldorpf.....                            | 252, 256           | pour sinus sphénoïdal .....                         | 697       |
| <b>E</b>  |                   | Ecarteur, Mikulicz.....                               | 273                | Finocchio, Pince à disséquer et à ligatures.....    | 198       |
| Ecarteur .....                                      | 238               | Ecarteur, Mikulicz.....                               | 272                | Finocchio, Porte-aiguilles.....                     | 412, 423  |
| Ecarteur à os, Rasse .....                          | 226               | Ecarteur, Ollier .....                                | 240                | Finsen-Martin, Ecarteur autostatique .....          | 280       |
| Ecarteur abdominal, Balfour.....                    | 312-313           | Ecarteur, Parker .....                                | 278                | Finsen, Ecarteur autostatique .....                 | 280       |
| Ecarteur abdominal, Balfour-Baby .....              | 311               | Ecarteur, Parker-Langenbeck .....                     | 279                | Fisch, Micro Dissecteur .....                       | 662       |
| Ecarteur abdominal, Balfour-Standard .....          | 314               | Ecarteur, Parker-Mott .....                           | 278                | Fisher, Bistouri pour amygdales .....               | 727       |
| Ecarteur abdominal, Balfour, Mod. USA .....         | 315               | Ecarteur, Richardson .....                            | 253                | Fomon, Ciseau-burin .....                           | 707       |
| Ecarteur abdominal, Collin .....                    | 304-306           | Ecarteur, Richardson-Eastman .....                    | 252                | Fomon, Ciseaux nasaux .....                         | 50, 83-84 |
| Ecarteur abdominal, Collin, Baby.....               | 304, 307, 308     | Ecarteur, Roux .....                                  | 276                | Fomon, Couteau pour plastique du nez .....          | 699       |
| Ecarteur abdominal, Gosset .....                    | 310-311           | Ecarteur, Roux-Baby.....                              | 277                | Fomon, Crochet pour les ailes du nez.....           | 715-716   |
| Ecarteur abdominal, Gosset-Baby.....                | 310               | Ecarteur, Roux-Mini.....                              | 277                | Fomon, Râpe nasale .....                            | 712, 714  |
| Ecarteur abdominal, Kirschner .....                 | 317-318           | Ecarteur, Sauerbruch .....                            | 264                | Forceps obstétrique, Kielland .....                 | 639       |
| Ecarteur abdominal, O'Sullivan-O'Connor .....       | 316               | Ecarteur, seul, Ricard .....                          | 307                | Forceps obstétrique, Nägele .....                   | 638       |
| Ecarteur abdominal, Ricard .....                    | 307               | Ecarteur, Simon .....                                 | 259                | Forceps obstétrique, Piper .....                    | 639       |
| Ecarteur autostatique .....                         | 280, 286-287, 302 | Ecarteur, Volkmann .....                              | 236-238            | Forceps obstétrique, Simpson.....                   | 638       |
| Ecarteur autostatique, Adson.....                   | 285, 294-295, 298 | Ecarteur, Wassmund .....                              | 241                | Forceps obstétrique, Wrigley .....                  | 638       |
| Ecarteur autostatique, Alm .....                    | 281               | Ecarteur, Zenker.....                                 | 250                | Foregger, Jeu à laryngoscopie.....                  | 391-392   |
| Ecarteur autostatique, Anderson-Adson.....          | 282               | Ecarteurs pour le genou, Blount .....                 | 507                | Foregger, Jeu à laryngoscopie (lumière froide)..... | 396       |
| Ecarteur autostatique, Beckman-Adson .....          | 299-300           | Ecarteurs pour le genou, Blount.....                  | 507                | Foregger, Spatule à laryngoscopie .....             | 392-393   |
| Ecarteur autostatique, Beckmann.....                | 298               | Ecarteurs spinaux, Taylor .....                       | 507                | Foregger, Spatule à laryngoscopie                   |           |
| Ecarteur autostatique, Cloward .....                | 296-297           | Echlin, Pincées-gouges .....                          | 527                | (lumière froide).....                               | 397       |
| Ecarteur autostatique, Finsen .....                 | 280               | Ecraseur pour intestin, Payr .....                    | 565                | Förster, Pince pour éponges .....                   | 222-223   |
| Ecarteur autostatique, Finsen-Martin .....          | 280               | Ecraseur pour intestin, Payr-Baby.....                | 565                | Foster-Gillies, Porte-aiguilles.....                | 428       |
| Ecarteur autostatique, Gelpi .....                  | 303               | Ecrou à oreilles, Alan-Parks .....                    | 580                | Fraenkel, Embout interchangeable .....              | 732       |
| Ecarteur autostatique, Henley .....                 | 293               | Ecrou moleté.....                                     | 518                | Frazier, Canules d'aspiration .....                 | 364       |
| Ecarteur autostatique, Jansen .....                 | 281               | Ecrou-raccord.....                                    | 763                | Freer, Bistouri pour la cloison nasale.....         | 700       |
| Ecarteur autostatique, Low-Profile .....            | 302               | Eicken-Killian, Canule à irrigation.....              | 720                | Freer, Ciseau-burin pour la cloison nasale .....    | 705       |
| Ecarteur autostatique, Martin .....                 | 301               | Eiselsberg, Ciseaux à ligatures .....                 | 108                | Freer, Couteau pour muqueuse.....                   | 700       |
| Ecarteur autostatique, Milligan .....               | 292               | Elevateur pour la cloison nasale,                     |                    | Freer, Crochet pour la muqueuse .....               | 716       |
| Ecarteur autostatique, Mollison .....               | 289               | Ballenger-Hajek.....                                  | 703                | Freer, Elevateur pour la cloison nasale .....       | 701-702   |
| Ecarteur autostatique, Norfolk-Norwich .....        | 283               | Elevateur pour la cloison nasale, Cottle.....         | 703-704            | Freer, Gouge pour la cloison nasale .....           | 705       |
| Ecarteur autostatique, Plester .....                | 290               | Elevateur pour la cloison nasale, Freer .....         | 701-702            | French, Diapason .....                              | 666       |
| Ecarteur autostatique, Scalp-Contour .....          | 282               | Elevateur pour la cloison nasale, Halle .....         | 701                | Friedmann, Pincées-gouges .....                     | 522       |
| Ecarteur autostatique, Travers .....                | 283               | Elevateur pour la cloison nasale, Howard .....        | 703                | Fritsch, Ecarteur.....                              | 257       |
| Ecarteur autostatique, Weitlaner.....               | 284, 287-288      | Elevateur pour la cloison nasale, Joseph .....        | 701                | Frosch, Daviers porte-os .....                      | 513       |
| Ecarteur autostatique, Weitlaner-Baby.....          | 292               | Elevateur pour la cloison nasale, Killian.....        | 703                | Fryholm, Pincées-gouges.....                        | 528       |
| Ecarteur autostatique, Weitlaner-Wullstein.....     | 289               | Elevateur pour la cloison nasale, McKenty .....       | 701-702            | Fuller, Pince pour introduction .....               | 658       |
| Ecarteur autostatique, Williams .....               | 291               | Elevateur pour la cloison nasale, Pennington.....     | 704                |   |           |
|   |                   | Elévateur pour le périoste, Cottle .....              | 704                |   |           |

- G**
- Gellhorn, Pince pour biopsie .....628  
 Gelpi, Ecarteur autostatique .....303  
 Gemini, Pince à disséquer et à ligatures .....192  
 Gerald, Pince à dissection .....130  
 Gerald, Pince à dissection à griffes .....131, 142  
 Gerald, Pince atraumatique à dissection .....136  
 Gil-Vernet, Ecarteur sous forme de selle .....233  
 Gillies-Mini, Porte-aiguilles .....428  
 Gillies, Pince à dissection à griffes .....131, 140  
 Gillies, Porte-aiguilles .....414, 428  
 Gobelet pour instruments .....753  
 Goelet, Ecarteur .....279  
 Goldman-Fox, Ciseaux à gencives .....91  
 Goldman-Fox, Ciseaux chirurgicaux .....91  
 Goldsmith (Thudichum), Spéculum nasal .....680  
 Good, Ciseaux pour les amygdales .....81  
 Gorney-Freeman, Ciseaux pour Face-lift .....118  
 Gorney, Ciseaux pour Face-lift .....45, 119  
 Gosset-Baby, Ecarteur abdominal .....310  
 Gosset, Ecarteur abdominal .....310-311  
 Gosset, Valve centrale .....310  
 Gouge .....457  
 Gouge pour la cloison nasale, Ballenger .....705  
 Gouge pour la cloison nasale, Freer .....705  
 Gouge pour la cloison nasale, Killian .....705  
 Gouge pour la cloison nasale, Killian-Claus .....705  
 Gouge, Alexander .....459  
 Gouge, Cobb .....470  
 Gouge, Hibbs .....472  
 Gouge, Lexer .....465  
 Gouge, Lexer-Mini .....464  
 Gouge, Partsch .....458  
 Gouge, Stille .....461  
 Gouge, Walter .....707  
 Gouge, Zielke .....459  
 Graefe, Micro Crochet .....226  
 Graig, Pince pour la cloison nasale .....687  
 Grave, Spéculum vaginal .....601  
 Green-Armytage, Pince utérine pour hémostase .....640  
 Greene, Curette utérine .....636  
 Gross-Maier, Pince à pansements .....220  
 Gross, Curette auriculaire .....677  
 Grünwald (Jansen), Pince à pansements .....686  
 Grünwald, Pince auriculaire .....671  
 Guedel-Negus, Jeu à laryngoscopie .....390  
 Guedel-Negus, Spatule à laryngoscopie .....390  
 Guilen, Obturateur .....720  
 Guilen, Rugine-raspatoire à succion .....720  
 Gunnar-Hey, Pince à roulette .....215  
 Guthrie, Crochet pour la peau .....227  
 Guttmann, Spéculum vaginal .....601  
 Guyon, Bougie urétrale .....594  
 Guyon, Pince-clamps pour pédicules rénaux .....199-200
- H**
- Haberer, Spatule abdominale .....348  
 Hajek, Pince emporte-pièces pour sinus sphénoïdal .....696  
 Halle, Curette tranchante .....485  
 Halle, Elevateur pour la cloison nasale .....701  
 Halsey, Porte-aiguilles .....409, 420  
 Halsted-Mosquito, Pince hémostatique .....171, 172  
 Hank, Dilatateur du col de l'utérus .....617  
 Harrington, Ecarteur .....267  
 Harrington, marTract .....339  
 Hartmann-Halle, Spéculum nasal .....680  
 Hartmann-Herzfeld, Pince pour polypes auriculaires .....673  
 Hartmann-Hoffmann, Pince pour polypes auriculaires .....673  
 Hartmann-Wullstein, Pince pour polypes auriculaires .....673  
 Hartmann, Diapason .....666-668  
 Hartmann, Levier pour corps étrangers .....677  
 Hartmann, Pince à polypes nasaux .....686  
 Hartmann, Pince hémostatique .....171  
 Hartmann, Pince nasale coupante .....693  
 Hartmann, Pince pour amygdales .....731  
 Hartmann, Pince pour polypes auriculaires .....672-673  
 Hartmann, Pincés-gouges .....523  
 Hartmann, Repose-pied .....668  
 Hartmann, Sonde auriculaire .....670  
 Hartmann, Spécula auriculaires (jeu) .....664  
 Hartmann, Spécula auriculaires, jeu .....664  
 Hayes, Pince pour anastomose rectale .....576  
 Heaney, Pince à hystérectomie .....204  
 Heaney, Porte-aiguilles .....411, 422
- Heavy Duty, Micro porte-aiguilles .....416  
 Hegar-Baumgartner, Porte-aiguilles .....410, 420  
 Hegar-Vascular, Porte-aiguilles .....425  
 Hegar, Dilatateur du col de l'utérus .....614-616  
 Hegar, Porte-aiguilles .....425  
 Hegenbarth, Pince à poser les agrafes .....439  
 Heiming, Pince pour les calculs du bassin .....584  
 Heiss, Pince à disséquer et à ligatures .....186  
 Henke, Elévateurs pour amygdales .....728  
 Henley, Ecarteur autostatique .....293  
 Henley, Valve centrale .....293  
 Hennig, Pince pour plâtre .....448  
 Hepp-Scheidel, Micro porte-aiguilles .....415  
 Hepp-Scheidel, Pince pour saisir les trompes .....147  
 Heymann, Ciseaux nasaux .....86-87  
 Heywood-Smith, Pince à polypes utérins .....623  
 Hibbs, Ciseau-burin .....471  
 Hibbs, Gouge .....472  
 Hibbs, Ostéotome .....471-472  
 Hohenfellner, Ciseaux à dissection .....49  
 Hohmann, Levier à os .....503-505  
 Hohmann, mini, Levier à os .....502  
 Hoke, Ostéotome .....471  
 Hopkins, Couteau pour plâtre .....447  
 Hösel, Ecarteur .....255  
 House-Dieter, Pince pour l'os marteau .....657  
 House, Adaptateur d'aspiration .....374  
 House, Micro Curette .....663  
 House, Micro Sonde pour mesurer .....663  
 House, Tube d'aspiration .....374  
 Howard, Elevateur pour la cloison nasale .....703  
 Huber, Manche universel .....632  
 Humby, Dermatome .....14  
 Humby, Lame de rechange .....14  
 Hunter, Pince à échardes .....154  
 Hurd, Dissecteur/Rétracteur pour amygdales .....727  
 Hystéromètre, Sims .....618  
 Hystéromètre, Valleix .....618
- I**
- Instrument d'insertion de cathéter, Dittel .....388  
 Instrument de circoncision .....596  
 Instrument de circoncision, Mogen .....596  
 Instrument pour passer les tendons .....508  
 Instruments à écorcher les tendons .....508  
 Iowa, Pince pour le col de l'utérus .....621  
 Israel, Ecarteur .....242  
 Iterson, Ecarteur pour trachéotomie .....549  
 Ives-Fansler, Anuscope .....579
- J**
- Jabaley, Ciseaux à iridectomie .....100  
 Jaboma, Micro porte-aiguilles .....415  
 Jaboma, Micro-Ciseaux .....105  
 Jaboma, Pince à dissection .....135  
 Jaboma, Pince à dissection à griffes .....135  
 Jackson, Ecarteur pour trachéotomie .....549  
 Jackson, Spéculum vaginal .....602  
 Jacobs, Pince pour le col de l'utérus .....621  
 Jacobson, Curette double .....486  
 Jameson, Ciseaux à dissection .....69  
 Jameson, Porte-aiguilles .....412  
 Jameson, Tube d'aspiration .....377  
 Jansen, Curette auriculaire .....677  
 Jansen, Ecarteur autostatique .....281  
 Jansen, Pince auriculaire .....671  
 Jansen, Pincés-gouges .....523  
 Jeu à laryngoscopie (lumière froide), Foregger .....396  
 Jeu à laryngoscopie (lumière froide), McIntosh .....394  
 Jeu à laryngoscopie (lumière froide), Miller .....398  
 Jeu à laryngoscopie, Foregger .....391-392  
 Jeu à laryngoscopie, Guedel-Negus .....390  
 Jeu à laryngoscopie, McIntosh .....391  
 Jeu à laryngoscopie, Miller .....389  
 Jeu à laryngoscopie, Miller-Baby .....389  
 Jeu de manucure pour infirmières .....744  
 Jeweler mod., Micr pince à dilater .....150  
 Jeweler mod., Micro-Pince .....150  
 Johns-Hopkins, Clamps Bulldog .....163  
 Johnson, Porte-aiguilles .....413  
 Joll, Ecarteur pour thyroïde et vulva .....303  
 Jones, Pince à champs .....211  
 Joseph-Masing, Elévateur pour le périoste .....704  
 Joseph, Ciseaux chirurgicaux .....60-61  
 Joseph, Couteau pour plastie du nez .....699  
 Joseph, Crochet nasal .....715-716  
 Joseph, Elevateur pour la cloison nasale .....701  
 Joseph, Elévateur pour le périoste .....704  
 Joseph, Lime à os .....711
- Joseph, Scie nasale .....709  
 Judd-Allis, Pince pour saisir intestins et tissus .....557  
 Judd-Masson, Ecarteur vésical .....592
- K**
- Kader, Spatule abdominale .....275  
 Kahre-Williger, Rugine-raspatoire .....494  
 Kallmorgen, Spéculum vaginal .....607  
 Kallmorgen, Valve vaginale .....607  
 Kaye, Ciseaux pour Face-lift .....44  
 Kaye, Manche pour bistouri .....8  
 Kelly-Rankin, Pince hémostatique .....175  
 Kelly, Ciseaux chirurgicaux .....32-33  
 Kelly, Ecarteur .....253, 273  
 Kelly, Pince à disséquer et à ligatures .....202  
 Kelly, Pince à polypes utérins .....623  
 Kelly, Pince hémostatique .....174  
 Kelly, Sphinctroscope .....581  
 Kern, Davier porte-os .....515  
 Kerrison, Pince emporte-pièces pour sinus maxillaire .....698  
 Kevorkian, Curette pour biopsie .....627  
 Kevorkian, Pince pour biopsie .....631  
 Key, Rugine-raspatoire .....491  
 Kielland, Forceps obstétrique .....639  
 Killian-Claus, Gouge pour la cloison nasale .....705  
 Killian, Elevateur pour la cloison nasale .....703  
 Killian, Gouge pour la cloison nasale .....705  
 Killian, Spéculum nasal .....681  
 Kilner, Ciseaux à dissection .....65  
 Kilner, Crochet pour les ailes du nez .....716  
 Kilner, Porte-aiguilles .....419  
 Kirschner, Cadre, seul .....317-319  
 Kirschner, Ecarteur abdominal .....317-318  
 Kirschner, marTract .....334  
 Kirschner, Valve .....317-319  
 Klapp, Ecarteur .....235  
 Kleinert-Kutz, Pincés pour saisir les tendons .....510  
 Knapp, Ciseaux à dissection .....114  
 Knapp, Ciseaux chirurgicaux .....22  
 Knight, Pince pour la cloison nasale .....687  
 Kocher (Ochsner), Pince hémostatique .....183-184  
 Kocher-Langenbeck, Ecarteur .....248-249  
 Kocher-Nippon, Pince hémostatique .....179  
 Kocher, Ecarteur .....239, 247, 251, 258  
 Kocher, Pince hémostatique .....179  
 Kocher, Pince intestinale .....563-564, 573-574  
 Kocher, Spatule à goitre .....550  
 Kogan, Endospéculum .....613  
 König, Diapason .....669  
 König, Rugine-raspatoire .....490  
 König, Sondes conductrices .....437  
 Körte, Ecarteur .....241  
 Krause-Voss, Serre-noeuds .....670, 684  
 Krause, Embout interchangeable .....733  
 Krause, Sonde auriculaire .....670, 684  
 Krenkel, Raspatoire pour palais .....701  
 Kressner, Pince pour la cloison nasale .....718  
 Kristeller, Spéculum vaginal .....603-606  
 Kristeller, Spéculum vaginal .....603-606  
 Kronecker, Aiguilles à ligatures .....432  
 Kübler, Ciseaux à dissection .....44  
 Kübler, Pince à dissection .....134  
 Kübler, Porte-aiguilles .....430  
 Kümmel, Spatule abdominale .....275
- L**
- La Grange, Ciseaux à gencives .....93  
 Laborde, Dilatateur pour la trachéotomie .....548  
 Lahey, Ecarteur .....246  
 Lahey, Pince à goitre .....550  
 Lahey, Pince pour les voies biliaires .....198  
 Lambotte-Mini, Ostéotome .....466  
 Lambotte, Ostéotome .....467-468  
 Lambotte, Rugine-raspatoire .....496  
 Lame ciseau-burin, interchangeable .....462  
 Lame de bistouri, (stériles) .....9  
 Lame de rechange, Humby .....14  
 Lame de rechange, Schink .....14  
 Lame de rechange, Silver .....14  
 Lame de rechange, Stille-Martin .....445  
 Lame de scie .....450  
 Lame ostéotome, interchangeable .....462  
 Landolt, Canules d'aspiration .....370  
 Landolt, Rugine-raspatoire .....490  
 Lane, Davier porte-os .....519  
 Lane, Pince à champs .....213  
 Lane, Pince stomacques et intestinales jumelées .....568-569

|   |                    |  |                   |  |                        |
|---|--------------------|--|-------------------|--|------------------------|
| Lange-Hohmann, Levier à os .....                      | 505                | Manche pour bistouri à tête pivotante .....            | 6                 | Metzenbaum-Fino, Ciseaux fins                        |                        |
| Lange, Crochet pour les ailes du nez .....            | 715                | Manche pour bistouri, Collin .....                     | 6                 | à dissection .....                                   | 53-58, 113, 117        |
| Lange, Embout interchangeable .....                   | 733                | Manche pour bistouri, Kaye .....                       | 8                 | Metzenbaum-Lahey, Ciseaux fins à dissection .....    | 117                    |
| Langenbeck-Green, Ecarteur .....                      | 245                | Manche pour ciseaux-burins .....                       | 462               | Metzenbaum-Nelson, Ciseaux à dissection .....        | 40                     |
| Langenbeck-Mini, Crochet .....                        | 229                | Manche pour miroir laryngien .....                     | 735               | Metzenbaum-Thorek, Ciseaux à dissection .....        | 115                    |
| Langenbeck, Daviers porte-os .....                    | 513                | Manche pour spéculum vaginal, Scherbak .....           | 609-610           | Metzenbaum, Ciseaux à dissection .....               | 37-44                  |
| Langenbeck, Ecarteur .....                            | 243-245            | Manche pour tubes d'aspiration, Coupland .....         | 378               | Metzenbaum, Porte-aiguilles .....                    | 410                    |
| Langenbeck, Élévateur .....                           | 500                | Manche tracteur, Nabatoff .....                        | 353               | Meyerding, Crochet .....                             | 230                    |
| Langenbeck, marTract .....                            | 335-336, 339       | Manche universel, Huber .....                          | 632               | Michel, Miroir laryngien .....                       | 735                    |
| Langenbeck, Porte-aiguilles .....                     | 430                | Manche, Yankauer .....                                 | 372               | Michel, Pince à poser les agrafes .....              | 439                    |
| Langenbeck, Rugine-raspatoire .....                   | 490                | Marquard, Pincés-gouges .....                          | 526               | Michel, Pince à poser les agrafes .....              | 440                    |
| Lawrence, Pince à disséquer et à ligatures .....      | 203                | Martel-Rees, Pince pour Face-lift .....                | 170               | Micr pince à dilater, Jeweler mod .....              | 150                    |
| Leksell-Stille, Pincés-gouges .....                   | 528                | Martin aquajet, Embout de rinçage .....                | 762-763           | Micro Aiguille auriculaire, Barbara .....            | 660-661                |
| Lempert, Curette auriculaire .....                    | 679                | Martin aquajet, Pistolet-laveur à jet d'eau .....      | 762               | Micro Aiguille auriculaire .....                     | 660                    |
| Lempert, Pincés-gouges .....                          | 523                | Martin-Alloy, Diapason .....                           | 667               | Micro Aiguille auriculaire, Shambaugh .....          | 662                    |
| Lempert, Rugine-raspatoire auriculaire .....          | 679                | Martin-Aseptic, Brosse à ongles .....                  | 742               | Micro Ciseaux auriculaires, Bellucci .....           | 654                    |
| Leriche, Pince hémostatique .....                     | 173                | Martin-Cushing, Rugine-raspatoire .....                | 489               | Micro Ciseaux auriculaires, Wullstein .....          | 655                    |
| Levier à os .....                                     | 502                | Martin-Fuchsig, Pince à disséquer et à ligatures ..... | 177               | Micro Crochet auriculaire .....                      | 661-662                |
| Levier à os, Bennett .....                            | 506                | Martin-Hoen, Rugine-raspatoire .....                   | 488               | Micro Crochet auriculaire, Barbara .....             | 660                    |
| Levier à os, Hohmann .....                            | 503-505            | Martin-Langenbeck, Élévateur .....                     | 500               | Micro Crochet auriculaire, McGee .....               | 661                    |
| Levier à os, Hohmann, mini .....                      | 502                | Martin-Langenbeck, Rugine-raspatoire .....             | 488               | Micro Crochet, Graefe .....                          | 226                    |
| Levier à os, Lange-Hohmann .....                      | 505                | Martin-Rochard, Barre transversale .....               | 323               | Micro Crochet, Rasse .....                           | 226                    |
| Levier obstétrique, Sellheim .....                    | 640                | Martin-Rochard, Bras de fixation .....                 | 323               | Micro Curette, House .....                           | 663                    |
| Levier pour corps étrangers, Hartmann .....           | 677                | Martin-Rochard, Ecarteur .....                         | 323               | Micro Dissecteur, Fisch .....                        | 662                    |
| Levier pour corps étrangers, Zaufal .....             | 677                | Martin-Rochard, Etau .....                             | 323               | Micro dissecteur, Varady .....                       | 352                    |
| Lewin, Daviers porte-os .....                         | 512                | Martin-Rochard, Maintien pour écarteur .....           | 323               | Micro Pince auriculaires .....                       | 648, 650-652           |
| Lewis, Râpe nasale .....                              | 712                | Martin-Rochard, Système d'ecarteurs .....              | 323               | Micro Pince auriculaires, Mini-McGee .....           | 649, 653               |
| Lexel-Baby, Ciseaux à dissection .....                | 51                 | Martin, Ciseaux coupe-fil .....                        | 124               | Micro porte-aiguilles .....                          | 404-405, 415, 417      |
| Lexel-Fino, Ciseaux fins à dissection .....           | 52                 | Martin, Couteau pour plâtre .....                      | 447               | Micro porte-aiguilles, Barraquer .....               | 406-407, 419           |
| Lexel-Mini, Gouge .....                               | 464                | Martin, Diapason .....                                 | 667               | Micro porte-aiguilles, Barraquer-Troutman .....      | 406                    |
| Lexel-Mini, Ostéotome .....                           | 464                | Martin, Distributeurs de brosses .....                 | 742-743           | Micro porte-aiguilles, Castroviejo .....             | 408, 418-419           |
| Lexel, Ciseaux à dissection .....                     | 46-48, 51, 115     | Martin, Ecarteur .....                                 | 259               | Micro porte-aiguilles, Castroviejo-Fino .....        | 407                    |
| Lexel, Ciseaux-burinix pour spongiosa .....           | 463                | Martin, Ecarteur autostatique .....                    | 301               | Micro porte-aiguilles, Castroviejo .....             | 416                    |
| Lexel, Gouge .....                                    | 465                | Martin, Etau de maintien universel .....               | 322, 323          | Micro porte-aiguilles, Hepp-Scheidel .....           | 415                    |
| Lexel, Ostéotome .....                                | 465                | Martin, Pelvimètre .....                               | 638               | Micro porte-aiguilles, Jaboma .....                  | 415                    |
| Lime à os .....                                       | 497                | Martin, Pince à pansements .....                       | 219               | Micro Rugine-Raspatoire auriculaire, Rosen .....     | 662                    |
| Lime à os, Joseph .....                               | 711                | Martin, Pince pour déchets .....                       | 768               | Micro Sonde pour mesurer, House .....                | 663                    |
| Lime à os, Miller-Colburn .....                       | 498-499            | Martin, Pince à cartilage .....                        | 512               | Micro-Ciseaux .....                                  | 76, 104-105            |
| Limes à ongles .....                                  | 745                | Martin, Porte-aiguilles .....                          | 423               | Micro-Ciseaux, Biemer .....                          | 105                    |
| Limes pour alvéolotomie, Miller .....                 | 499                | Martin, Spatule abdominale .....                       | 348               | Micro-Ciseaux, court .....                           | 70                     |
| Lister, Ciseaux pour pansements .....                 | 442, 446           | Martin, Spécule nasal .....                            | 681               | Micro-Ciseaux, Jaboma .....                          | 105                    |
| Lister, Pince Sinus .....                             | 219                | Martin, Système Bras Martin .....                      | 322               | Micro-Ecarteur pour vaisseaux .....                  | 228                    |
| Liston-Key, Pincés coupantes à os .....               | 534                | Martini, Porte-aiguilles .....                         | 426-427           | Micro-Pince .....                                    | 129, 141, 149-152, 158 |
| Liston, Couteau à amputation .....                    | 13                 | marTract .....   | 326-339, 341, 345 | Micro-Pince à dissection à anneau .....              | 150-152                |
| Liston, Pincés coupantes à os .....                   | 530                | marTract, Alan-Parks .....                             | 338               | Micro-Pince atraumatique à dissection .....          | 151                    |
| Littauer, Ciseaux à ligatures .....                   | 108                | marTract, Breisky .....                                | 340               | Micro-Pince, Jeweler mod .....                       | 150                    |
| Littauer, Pince à épiler les cils .....               | 155                | marTract, Deaver .....                                 | 337               | Microvasculaire, Porte-aiguilles .....               | 426                    |
| Little, Ecarteur .....                                | 246                | marTract, Harrington .....                             | 339               | Middeldorf, Ecarteur .....                           | 252, 256               |
| Locklin, Ciseaux à gencives .....                     | 94                 | marTract, Kirschner .....                              | 334               | Middleton-Jansen, Pince pour la cloison nasale ..... | 694                    |
| Lockwood, Pince pour saisir intestins et tissus ..... | 557                | marTract, Langenbeck .....                             | 335-336, 339      | Mikro-Adson, Pince à dissection .....                | 143                    |
| Lorenz, Ciseaux pour pansements .....                 | 442                | marTract, Richardson .....                             | 342               | Mikro-Adson, Pince à dissection à griffes .....      | 143                    |
| Lorna, Pince à champs .....                           | 212                | marTract, Roux .....                                   | 344               | Mikro-Adson, Pince à disséquer et à ligatures .....  | 170                    |
| Lovelace, Pince hémostatique .....                    | 176                | marTract, St. Marks .....                              | 343               | Mikro-Adson, Shigeno, Pince à dissection .....       | 143                    |
| Low-Profile, Ecarteur autostatique .....              | 302                | marTract, Volkman .....                                | 344               | Mikro-Mosquito, Pince hémostatique .....             | 173                    |
| Low-Profile, Plume .....                              | 302                | Masing, Élévateur pour le périoste .....               | 704               | Mikulicz-Baby, Pince pour le péritoine .....         | 209                    |
| Low-Profile, Valve centrale .....                     | 302                | Masson, Porte-aiguilles .....                          | 412, 422          | Mikulicz, Ecarteur .....                             | 273                    |
| Lower, Pince à disséquer et à ligatures .....         | 198                | Mathieu, Ecarteur .....                                | 279               | Mikulicz, Ecarteur .....                             | 272                    |
| Lubet-Barbon, Pince à pansements .....                | 686                | Mathieu, Pince pour corps étrangers .....              | 597               | Mikulicz, Pince pour le péritoine .....              | 209-210                |
| Lucae, Aiguille pour le tympan .....                  | 678                | Mathieu, Porte-aiguilles .....                         | 414, 428-429      | Miller-Baby, Jeu à laryngoscopie .....               | 389                    |
| Lucae, Bouton de rechange .....                       | 668                | Mayfield, Pincés-gouges .....                          | 526               | Miller-Colburn, Lime à os .....                      | 498-499                |
| Lucae, Crochet auriculaire .....                      | 677                | Mayo-Blake, Pince pour calculs biliaires .....         | 586               | Miller, Jeu à laryngoscopie .....                    | 389                    |
| Lucae, Diapason .....                                 | 668                | Mayo-Harrington, Ciseaux à dissection .....            | 29                | Miller, Jeu à laryngoscopie (lumière froide) .....   | 398                    |
| Lucae, Maillet .....                                  | 476                | Mayo-Hegar, Porte-aiguilles .....                      | 411, 421          | Miller, Limes pour alvéolotomie .....                | 499                    |
| Lucae, Socle .....                                    | 668                | Mayo-Lexel, Ciseaux à dissection .....                 | 116               | Miller, Spatule à laryngoscopie .....                | 389                    |
| Luer-Körte, Cures pour calculs biliaires .....        | 588                | Mayo-Noble, Ciseaux à dissection .....                 | 29                | Miller, Spatule à laryngoscopie                      |                        |
| Luer, Ecarteur pour trachéotomie .....                | 549                | Mayo-Robson, Pince intestinale .....                   | 562, 572          | (lumière froide) .....                               | 398-399                |
| Luer, Pincés-gouges .....                             | 525                | Mayo-Stille, Ciseaux à dissection .....                | 26-28             | Milligan, Ecarteur autostatique .....                | 292                    |
| Luer, Tube d'aspiration .....                         | 369                | Mayo, Ciseaux chirurgicaux .....                       | 24-25             | Millin, Ecarteur pour le col de la vessie .....      | 592                    |
| Lukens, Ecarteur pour le thymus .....                 | 549                | Mayo, Clip de stérilisation .....                      | 754               | Millin, Ecarteur vésical .....                       | 593                    |
| Lunettes protectrices .....                           | 746                | Mayo, Pince à dissection à griffes .....               | 146               | Millin, Pince pour saisir les capsules .....         | 590-591                |
| Luniatschek, Porte-tampon .....                       | 728                | McDonald, Dissecteur double .....                      | 501               | Millin, Valve centrale .....                         | 593                    |
| <b>M</b>  |                    | McGee, Micro Crochet auriculaire .....                 | 661               | Millin, Valve latérale .....                         | 593                    |
| M. G. Hospital, Porte-aiguilles .....                 | 411                | McGee, Pince à plier les fils d'acier .....            | 656               | Mini-Adson, Pince à dissection .....                 | 128                    |
| Magill, Pince pour introduire les sondes .....        | 388                | McGivney, Pincés-clamps pour hémorroïdes .....         | 582               | Mini-Adson, Pince à dissection à griffes .....       | 143                    |
| Maillet .....   | 477-480            | McIndoe, Pince à dissection .....                      | 128, 131          | Mini-clip vasculaire .....                           | 161                    |
| Maillet, Collin .....                                 | 476                | McIntosh, Jeu à laryngoscopie .....                    | 391               | Mini-Gemini, Pince à disséquer et à ligatures .....  | 192                    |
| Maillet, Cottle .....                                 | 476                | McIntosh, Jeu à laryngoscopie (lumière froide) .....   | 394               | Mini-Glover, Clamps Bulldog .....                    | 165-166                |
| Maillet, Doyen .....                                  | 475                | McIntosh, Spatule à laryngoscopie .....                | 391               | Mini-Glover, Pince pour poser micro-clips .....      | 166                    |
| Maillet, Lucae .....                                  | 476                | McIntosh, Spatule à laryngoscopie                      |                   | Mini-McGee, Micro Pince auriculaires .....           | 649, 653               |
| Maillet, Mead .....                                   | 477                | (lumière froide) .....                                 | 394-395           | Miroir laryngien .....                               | 734                    |
| Maillet, Partsch .....                                | 478                | McKenty, Élevateur pour la cloison nasale .....        | 701-702           | Miroir laryngien, Michel .....                       | 735                    |
| Maillet, Williger .....                               | 475, 477           | McQuigg-Mixter, Pince à disséquer                      |                   | Mixter-Baby, Pince à disséquer                       |                        |
| Maintien pour écarteur, Martin-Rochard .....          | 323                | et à ligatures .....                                   | 197               | et à ligatures .....                                 | 170, 186, 194          |
| Maltz, Râpe nasale .....                              | 711, 713           | Mead, Maillet .....                                    | 477               | Mixter, Pince à disséquer et à ligatures .....       | 195-197                |
| Manche .....  | 354, 369           | Mead, Pincés-gouges .....                              | 523               | Mixter, Pince pour calculs biliaires .....           | 587                    |
| Manche à pile .....                                   | 393                | Mead, Plaques de rechange .....                        | 477               | Mock, Aiguille pour héparine .....                   | 381, 384               |
| Manche à pile .....                                   | 394, 396, 398, 400 | Meeker, Pince à disséquer et à ligatures .....         | 203               | Mod. Bonn, Ciseaux à iridectomie .....               | 96                     |
| Manche pour bistouri .....                            | 5-8, 10            | Menghini, Aiguille pour ponction du foie .....         | 384               | Mod. Martin, Combinaison couvercle/pince .....       | 754                    |
|   |                    | Mesure graduée .....                                   | 757               | Mod. Martin, Sondes conductrices .....               | 436                    |



- Mod. München, Curette pour biopsie ..... 627  
 Mod. USA, Ciseaux pour le cordon ombilical.....90  
 Mod. Wien, Spéculum nasal .....682  
 Modell USA, Curette tranchante .....485  
 Modell Wien, Porte-ligature.....438  
 Mogen, Instrument de circoncision .....596  
 Mollison, Ecarteur autostatique .....289  
 Molt, Curette double.....487  
 Moynihan, Pince à hystérectomie .....207  
 Museux, Pince pour le col de l'utérus .....621
- N**  
 Nabatoff, Cable tracteur .....353  
 Nabatoff, Manche tracteur.....353  
 Nabatoff, Olive .....353  
 Nabatoff, Pointe en plastique.....353  
 Nabatoff, Trousse à varices .....353  
 Nägele, Forceps obstétrique .....638  
 Negus, Pince hémostatique .....203  
 Neivert-Anderson, Ostéotome .....708  
 Neivert, Crochet pour les ailes du nez .....717  
 Neivert, Porte-aiguilles .....409  
 Nelaton, Sonde cannelée.....351  
 Nelson, Pince à dissection à griffes .....147  
 Neuro, Diapason .....669  
 Norfolk-Norwich, Ecarteur autostatique .....283  
 Northbent, Ciseaux à ligatures .....107  
 Noto, Pince à polypes utérins.....623  
 Novak, Curette à aspiration .....627  
 Nuober, Tube d'aspiration .....377
- O**  
 O'Brian, Ciseaux à ligatures .....107  
 O'Connor, Crochet pour la peau .....227  
 O'Shaugnessy, Pince à disséquer et à ligatures .....195  
 O'Sullivan-O'Connor, Ecarteur abdominal .....316  
 O'Sullivan-O'Connor, Valve centrale .....316  
 Obturateur, Guilen .....720  
 Ochsner, Pince à fil .....438  
 Oehler, Pince à dissection à griffes .....134  
 Ogura, Pince pour saisir la peau .....719  
 Olive, Nabatoff .....353  
 Olive, Yankauer .....372  
 Olivecrona, Ciseaux à dissection .....79  
 Ollier, Ecarteur .....240  
 Olsen Hegar, Porte-aiguilles .....414, 427  
 Ostéotome .....456  
 Ostéotome emporte-pièces, Beyer .....675  
 Ostéotome, Cinelli .....708  
 Ostéotome, Cottle .....706  
 Ostéotome, Hibbs .....471-472  
 Ostéotome, Hoke .....471  
 Ostéotome, Lambotte .....467-468  
 Ostéotome, Lambotte-Mini .....466  
 Ostéotome, Lexer .....465  
 Ostéotome, Lexer-Mini .....464  
 Ostéotome, Neivert-Anderson .....708  
 Ostéotome, Rubin .....707  
 Ostéotome, Smith-Petersen .....469  
 Ostéotome, Stille .....460-461  
 Ostéotome, Walter .....707  
 Overholt-Baby, Pince à disséquer et à ligatures .....175  
 Overholt-Fino, Pince à disséquer et à ligatures .....190  
 Overholt-Geissendörfer, Pince à disséquer et à ligatures .....189  
 Overholt-Martin, Pince à disséquer et à ligatures...185  
 Overholt-Mini, Pince à disséquer et à ligatures .....191  
 Overholt-Mixer, Pince à disséquer et à ligatures ...186  
 Overholt, Pince à disséquer et à ligatures .....191
- P**  
 paire de tubes flexibles, seuls, Strauss .....598  
 Par-Style, Porte-aiguilles.....416  
 Parker-Langenbeck, Ecarteur .....279  
 Parker-Mott, Ecarteur .....278  
 Parker, Ecarteur .....278  
 Partsch, Ciseau-burin .....458  
 Partsch, Gouge .....458  
 Partsch, Maillet .....478  
 Payr-Baby, Ecraseur pour intestin .....565  
 Payr, Ecraseur pour intestin .....565  
 Payr, Sondes conductrices.....438  
 Pean (Rochester), Pince hémostatique .....181-182  
 Pean-Nippon, Pince hémostatique .....178  
 Pean, Pince hémostatique .....167, 178  
 Peck-Joseph, Ciseaux pour Face-lift.....62-63  
 Pederson, Spéculum vaginal .....601  
 Peers-Bertram modif., Pince à champs .....212  
 Peers-Bertram, Pince à champs .....213  
 Peet, Pince à échardes .....156  
 Pelvimètre, Martin .....638  
 Pennington, Elevateur pour la cloison nasale.....704  
 Pennington, Pince hémostatique .....169  
 Percy, Retracteur pour amputation .....521  
 Pestalozza, Curette à avortement et placenta.....642  
 Phaneuf, Pince à hystérectomie.....204  
 Pièce de raccordement .....636  
 Pignons métalliques .....474  
 Pignons métalliques, Caspar .....474  
 Pince à champs .....213  
 Pince à champs, Backhaus.....211  
 Pince à champs, Bernhard .....212  
 Pince à champs, Jones .....211  
 Pince à champs, Lane .....213  
 Pince à champs, Lorna .....212  
 Pince à champs, Peers-Bertram .....213  
 Pince à champs, Peers-Bertram modif. ....212  
 Pince à champs, Roeder .....212  
 Pince à champs, Schädel .....211  
 Pince à champs, Tohoku .....212  
 Pince à champs, Roeder .....212  
 Pince à champs, Schädel .....211  
 Pince à champs, Tohoku .....212  
 Pince à columella, Cottle .....719  
 Pince à dissection .....126-127, 148  
 Pince à dissection à griffes .....137-139, 143, 148  
 Pince à dissection à griffes, Adlerkreutz .....139  
 Pince à dissection à griffes, Adson .....132, 140  
 Pince à dissection à griffes, Adson-Brown .....132, 142  
 Pince à dissection à griffes, Bonney .....131, 146  
 Pince à dissection à griffes, Cushing .....142  
 Pince à dissection à griffes, Durante .....145  
 Pince à dissection à griffes, Gerald .....131, 142  
 Pince à dissection à griffes, Gillies .....131, 140  
 Pince à dissection à griffes, Jaboma .....135  
 Pince à dissection à griffes, Mayo .....146  
 Pince à dissection à griffes, Mikro-Adson .....143  
 Pince à dissection à griffes, Mini-Adson .....143  
 Pince à dissection à griffes, Nelson .....147  
 Pince à dissection à griffes, Oehler .....134  
 Pince à dissection à griffes, Potts-Smith .....142  
 Pince à dissection à griffes, Resano .....147  
 Pince à dissection à griffes, Russ. Modell .....145  
 Pince à dissection à griffes, Semken .....131, 140  
 Pince à dissection à griffes, Singley-Tuttle .....146  
 Pince à dissection à griffes, Stille .....139  
 Pince à dissection à griffes, Stille-Barraya .....145  
 Pince à dissection à griffes, Taylor .....141  
 Pince à dissection à griffes, Waugh .....140  
 Pince à dissection, Adson .....128, 132  
 Pince à dissection, Bonney .....127  
 Pince à dissection, Cushing .....130, 133  
 Pince à dissection, Cushing-Taylor .....133  
 Pince à dissection, Gerald .....130  
 Pince à dissection, Jaboma .....135  
 Pince à dissection, Kübler .....134  
 Pince à dissection, McIndoe .....128, 131  
 Pince à dissection, Mikro-Adson .....143  
 Pince à dissection, Mikro-Adson, Shigeno .....143  
 Pince à dissection, Mini-Adson .....128  
 Pince à dissection, Potts-Smith .....130, 133  
 Pince à dissection, Schweden-Modell .....128  
 Pince à dissection, Semken .....129  
 Pince à dissection, Taylor .....129  
 Pince à dissection, Wangenstein .....134  
 Pince à dissection, Waugh .....128  
 Pince à disséquer et à ligatures, Adson .....177  
 Pince à disséquer et à ligatures, Adson-Baby .....186  
 Pince à disséquer et à ligatures, Baby-Adson .....170  
 Pince à disséquer et à ligatures, Crafoord .....188  
 Pince à disséquer et à ligatures, Finochietto .....198  
 Pince à disséquer et à ligatures, Gemini .....192  
 Pince à disséquer et à ligatures, Heiss .....186  
 Pince à disséquer et à ligatures, Kelly .....202  
 Pince à disséquer et à ligatures, Lawrence .....203  
 Pince à disséquer et à ligatures, Lower .....198  
 Pince à disséquer et à ligatures, Martin-Fuchsig .....177  
 Pince à disséquer et à ligatures, McQuigg-Mixer .....197  
 Pince à disséquer et à ligatures, Meeker .....203  
 Pince à disséquer et à ligatures, Mikro-Adson .....170  
 Pince à disséquer et à ligatures, Mini-Gemini .....192  
 Pince à disséquer et à ligatures, Mixer .....195-197  
 Pince à disséquer et à ligatures, Mixer-Baby .....170, 186, 194  
 Pince à disséquer et à ligatures, O'Shaugnessy .....195  
 Pince à disséquer et à ligatures, Overholt .....191  
 Pince à disséquer et à ligatures, Overholt-Baby .....175  
 Pince à disséquer et à ligatures, Overholt-Fino .....190  
 Pince à disséquer et à ligatures, Overholt-Geissendörfer .....189  
 Pince à disséquer et à ligatures, Overholt-Martin...185  
 Pince à disséquer et à ligatures, Overholt-Mini .....191  
 Pince à disséquer et à ligatures, Overholt-Mixer .....186  
 Pince à disséquer et à ligatures, Rumel .....193  
 Pince à disséquer et à ligatures, Sarot .....187  
 Pince à disséquer et à ligatures, Schmidt .....177  
 Pince à disséquer et à ligatures, Wikstroem .....196  
 Pince à disséquer et à ligatures, Zenker .....194  
 Pince à échardes .....153-154  
 Pince à échardes, Feilchenfeld .....154  
 Pince à échardes, Hunter .....154  
 Pince à échardes, Peet .....156  
 Pince à échardes, Stieglitz .....156  
 Pince à épiler les cils .....155  
 Pince à épiler les cils, Barraquer .....155  
 Pince à épiler les cils, Beer .....155  
 Pince à épiler les cils, Douglas .....155  
 Pince à épiler les cils, Littauer .....155  
 Pince à fil, Ochsner .....438  
 Pince à goitre, Lahey .....550  
 Pince à hystérectomie, Heaney .....204  
 Pince à hystérectomie, Moynihan .....207  
 Pince à hystérectomie, Phaneuf .....204  
 Pince à hystérectomie, Rogers .....206  
 Pince à hystérectomie, Wertheim .....208  
 Pince à ligatures .....171  
 Pince à pansements, Bryant .....219  
 Pince à pansements, Cheron .....221  
 Pince à pansements, Collin .....221  
 Pince à pansements, Gross-Maier .....220  
 Pince à pansements, Grünwald (Jansen) .....686  
 Pince à pansements, Lubet-Barbon .....686  
 Pince à pansements, Martin .....219  
 Pince à pansements, Tröltzsch .....686  
 Pince à pansements, Westmacott .....686  
 Pince à plier les fils d'acier, McGee .....656  
 Pince à polypes nasaux, Hartmann .....686  
 Pince à polypes utérins, Heywood-Smith .....623  
 Pince à polypes utérins, Kelly .....623  
 Pince à polypes utérins, Noto .....623  
 Pince à poser les agrafes, Childre .....439  
 Pince à poser les agrafes, Hegenbarth .....439  
 Pince à poser les agrafes, Michel .....439  
 Pince à poser les agrafes, Michel .....440  
 Pince à poser les agrafes, Richter .....440  
 Pince à poser les agrafes, Wachenfeldt .....439  
 Pince à roulette, Brompton .....215  
 Pince à roulette, Gunnar-Hey .....215  
 Pince à tampons, Ulrich .....218  
 Pince à tumeurs à vis, Collin .....169  
 Pince atraumatique à dissection .....130  
 Pince atraumatique à dissection, DeBakey ...135-136  
 Pince atraumatique à dissection, Gerald .....136  
 Pince auriculaire, Grünwald .....671  
 Pince auriculaire, Jansen .....671  
 Pince auriculaire, Tröltzsch (Wilde) .....671  
 Pince d'horloger .....144  
 Pince emporte-pièces pour sinus maxillaire .....692  
 Pince emporte-pièces pour sinus maxillaire, Kerrison .....698  
 Pince emporte-pièces pour sinus sphénoïdal, Ferris-Smith-Kerrison .....697  
 Pince emporte-pièces pour sinus sphénoïdal, Hajek .....696  
 Pince éthmoïdale .....689  
 Pince éthmoïdale, Takahashi .....688  
 Pince éthmoïdale, Watson-Williams .....689  
 Pince éthmoïdale, Weil-Blakesley .....690  
 Pince hémostatique, Bengolea .....180  
 Pince hémostatique, Chaput .....168  
 Pince hémostatique, Crile .....175  
 Pince hémostatique, Crile-Rankin .....176  
 Pince hémostatique, Dandy .....176  
 Pince hémostatique, Dandy-Mosquito .....176  
 Pince hémostatique, Dunhill .....174  
 Pince hémostatique, Halsted-Mosquito .....171-172  
 Pince hémostatique, Hartmann .....171  
 Pince hémostatique, Kelly .....174  
 Pince hémostatique, Kelly-Rankin .....175  
 Pince hémostatique, Kocher .....179  
 Pince hémostatique, Kocher (Ochsner) .....183-184  
 Pince hémostatique, Kocher-Nippon .....179  
 Pince hémostatique, Leriche .....173  
 Pince hémostatique, Lovelace .....176  
 Pince hémostatique, Mikro-Mosquito .....173  
 Pince hémostatique, Negus .....203  
 Pince hémostatique, Pean .....167, 178  
 Pince hémostatique, Pean (Rochester) .....181-182  
 Pince hémostatique, Pean-Nippon .....178

# Index alphabétique

## Français

|  |                  |   |          |   |               |
|--|------------------|---|----------|---|---------------|
| Pince hémostatique, Pennington .....                                     | 169              | Pince pour pénis, Strauss .....                             | 598      | Pincettes-gouges, Luer .....  | 525           |
| Pince hémostatique, Providence-Hospital.....                             | 173              | Pince pour plâtre, Hennig .....                             | 448      | Pincettes-gouges, Marquard .....  | 526           |
| Pince hémostatique, Rochester-Carmalt .....                              | 177              | Pince pour plâtre, Quattro .....                            | 448      | Pincettes-gouges, Mayfield .....  | 526           |
| Pince hémostatique, Spencer-Wells .....                                  | 167              | Pince pour polypes auriculaires, Buck .....                 | 672      | Pincettes-gouges, Mead .....  | 523           |
| Pince hémostatique, Tuffier .....  | 168              | Pince pour polypes auriculaires, Citelli .....              | 674      | Pincettes-gouges, Ruskin .....  | 526           |
| Pince hystérolabe, Collin .....  | 625              | Pince pour polypes auriculaires, Hartmann.....              | 672-673  | Pincettes-gouges, Semb .....  | 526           |
| Pince hystérolabe, Dartigues .....                                       | 625              | Pince pour polypes auriculaires,<br>Hartmann-Herzfeld ..... | 673      | Pincettes-gouges, Stille-Brink .....  | 522           |
| Pince hystérolabe, Somer .....   | 625              | Pince pour polypes auriculaires,<br>Hartmann-Hoffmann ..... | 673      | Pincettes-gouges, Stille .....  | 526           |
| Pince intestinale, Allen .....   | 564              | Pince pour polypes auriculaires,<br>Hartmann-Wulstein ..... | 673      | Pincettes-gouges, Stille-Luer .....   | 529           |
| Pince intestinale, Doyen .....   | 560              | Pince pour polypes auriculaires, Strümpel .....             | 673      | Pincettes-gouges, Stille-Ruskin .....                                       | 527           |
| Pince intestinale, Doyen-Baby .....                                      | 561, 571         | Pince pour poser les clips vasculaires .....                | 158      | Pincettes-gouges, Zaufal-Jansen .....                                       | 525           |
| Pince intestinale, Weil .....  | 563-564, 573-574 | Pince pour saisir micro-clips .....                         | 161      | Pincette pour saisir et casser les lames<br>de rasoir .....                 | 4             |
| Pince intestinale, Mayo-Robson .....                                     | 562, 572         | Pince pour poser micro-clips, Mini-Glover .....             | 166      | Pincette pour saisir et casser les lames<br>de rasoir, Castroviejo .....    | 4             |
| Pince intestinale, Scudder .....   | 575              | Pince pour rompre plâtre, Wolff .....                       | 449      | Pincette pour saisir et casser les lames<br>de rasoir, Troutman-Chris ..... | 4             |
| Pince micro avec contrepoids .....                                       | 150              | Pince pour saisir intestins et tissus, Allis .....          | 556-557  | Piper, Forceps obstétrique .....  | 639           |
| Pince nasale coupante, Hartmann .....                                    | 693              | Pince pour saisir intestins et tissus, Allis-Adair .....    | 557      | Pistolet-laveur à jet d'eau, Martin aquajet .....                           | 762           |
| Pince nasale coupante, Struycken .....                                   | 691              | Pince pour saisir intestins et tissus, Allis-Baby .....     | 556      | Plaque de rechange .....  | 478-479       |
| Pince nasale coupante, Weil .....  | 689              | Pince pour saisir intestins et tissus,<br>Babcock .....     | 558-559  | Plaque de silicone .....  | 753           |
| Pince nasale coupante, Weil-Blakesley .....                              | 690              | Pince pour saisir intestins et tissus, Boys-Allis .....     | 557      | Plaque pour tendre la peau, Schink .....                                    | 14            |
| Pince placentaire et pour poste-abortum,<br>Sänger .....                 | 640              | Pince pour saisir intestins et tissus, Duval .....          | 559-560  | Plaques de rechange, Mead .....   | 477           |
| Pince placentaire et pour poste-abortum,<br>Winter .....                 | 640              | Pince pour saisir intestins et tissus, Judd-Allis .....     | 557      | Plateau pour instruments .....  | 758           |
| Pince pour amygdales, Hartmann .....                                     | 731              | Pince pour saisir intestins et tissus, Lockwood .....       | 557      | Plateau universel .....   | 758           |
| Pince pour anastomose rectale, Fehland .....                             | 577              | Pince pour saisir intestins et tissus, Thoms-Allis .....    | 557      | Plester, Canule d'aspiration .....  | 383           |
| Pince pour anastomose rectale, Hayes .....                               | 576              | Pince pour saisir intestins et tissus, Williams .....       | 558      | Plester, Couteau lobaire .....  | 659           |
| Pince pour anastomose rectale, Resano .....                              | 578              | Pince pour saisir la peau, Cottle .....                     | 719      | Plester, Ecarteur autostatique .....  | 290           |
| Pince pour anastomose rectale, Veidenheimer .....                        | 577              | Pince pour saisir la peau, Ogura .....                      | 719      | Plume, Low-Profile .....  | 302           |
| Pince pour anastomoses intestinale,<br>De Martel-Wolfson .....           | 566              | Pince pour saisir les capsules, Millin .....                | 590-591  | Poids pour spéculum vaginal, Auvard .....                                   | 611           |
| Pince pour anastomoses rectales, Brunner .....                           | 575              | Pince pour saisir les trompes, Hepp-Scheidel .....          | 147      | Poids pour spéculum vaginal, Scherbak .....                                 | 610           |
| Pince pour biopsie, Alexander .....                                      | 631              | Pince pour saisir organes .....                             | 168      | Poids, Rydel-Seiffert .....   | 669           |
| Pince pour biopsie, Faure .....  | 628              | Pince pour saisir organes, Collin .....                     | 169      | Pointe de succion, Coughland .....  | 378           |
| Pince pour biopsie, Gellhorn .....                                       | 628              | Pince pour saisir organes, Scheibe .....                    | 570      | Pointe de succion, Wulstein .....   | 368           |
| Pince pour biopsie, Kevorkian .....                                      | 631              | Pince pour tunnelisation .....                              | 220      | Pointe de succion, Yankauer .....   | 372           |
| Pince pour biopsie, Schubert .....                                       | 628-629          | Pince presse-tubes .....                                    | 213-214  | Pointe de succion, Zoellner .....   | 368           |
| Pince pour biopsie, Schumacher .....                                     | 631-632          | Pince Sinus, Lister .....                                   | 219      | Pointe en plastique, Nabatoff .....   | 353           |
| Pince pour biopsie, Thoms-Gaylor .....                                   | 629              | Pince stomacales et intestinales jumelées,<br>Lane .....    | 568-569  | Politzer, Aiguille pour le tympan .....                                     | 678           |
| Pince pour biopsie, Van Doren .....                                      | 630              | Pince tangentielle, Uro-Tangential .....                    | 199      | Poole, Tube d'aspiration .....  | 373           |
| Pince pour calculs biliaires, Blake .....                                | 586              | Pince utérine pour hémostase,<br>Green-Armytage .....       | 640      | Poppen, Canules d'aspiration .....  | 367           |
| Pince pour calculs biliaires, Desjardins .....                           | 587              | Pince vaginale, Wertheim-Cullen .....                       | 205      | Porte-aiguilles, Adson .....  | 410           |
| Pince pour calculs biliaires, Mayo-Blake .....                           | 586              | Pince-clamps pour pédicules rénaux,<br>Guyon .....          | 199-200  | Porte-aiguilles, Bozemann .....   | 425           |
| Pince pour calculs biliaires, Mixter .....                               | 587              | Pince-gouge à cartilage, Cottle .....                       | 710      | Porte-aiguilles, Brown .....  | 410           |
| Pince pour corps étrangers, Mathieu .....                                | 597              | Pince-gouge pour la cloison nasale .....                    | 694      | Porte-aiguilles, Clapper .....  | 409           |
| Pince pour déchets, Martin .....   | 768              | Pince-gouge pour la cloison nasale, Rubin .....             | 695      | Porte-aiguilles, Crile .....  | 414           |
| Pince pour déchets, Sauerbruch .....                                     | 768              | Pincettes à cartilage, Bircher-Ganske .....                 | 511      | Porte-aiguilles, Crile-Murray .....   | 410           |
| Pince pour DIU .....   | 632              | Pincettes à cartilage, Dingmann .....                       | 511      | Porte-aiguilles, Crile-Wood .....   | 410, 415, 420 |
| Pince pour éponges, Bergmann .....                                       | 222              | Pincettes à cartilage, Martin .....                         | 512      | Porte-aiguilles, DeBaKey .....  | 422           |
| Pince pour éponges, Bozemann .....                                       | 221              | Pincettes à envies .....                                    | 745      | Porte-aiguilles, Derf .....   | 409, 419      |
| Pince pour éponges, Förster .....  | 222-223          | Pincettes à envies .....                                    | 745      | Porte-aiguilles, Fochiochetto .....   | 412, 423      |
| Pince pour éponges, Rampley .....  | 223              | Pincettes à réduction .....                                 | 512      | Porte-aiguilles, Foster-Gillies .....                                       | 428           |
| Pince pour Face-lift, Martel-Rees .....                                  | 170              | Pincettes à réduction .....                                 | 512, 514 | Porte-aiguilles, Gillies .....  | 414, 428      |
| Pince pour fermer les clamps,<br>De Martel-Wolfson .....                 | 566              | Pincettes coupantes à os, Böhler .....                      | 531      | Porte-aiguilles, Gillies-Mini .....   | 428           |
| Pince pour instruments stérilisés .....                                  | 750              | Pincettes coupantes à os, Cleveland .....                   | 531      | Porte-aiguilles, Halsey .....   | 409, 420      |
| Pince pour instruments stérilisés, Cheattle .....                        | 750              | Pincettes coupantes à os, Cottle-Kazanjian .....            | 530      | Porte-aiguilles, Heaney .....   | 411, 422      |
| Pince pour introduction, Fuller .....                                    | 658              | Pincettes coupantes à os, Liston .....                      | 530      | Porte-aiguilles, Hegar .....  | 425           |
| Pince pour introduire les sondes, Magill .....                           | 388              | Pincettes coupantes à os, Liston-Key .....                  | 534      | Porte-aiguilles, Hegar-Baumgartner .....                                    | 410, 420      |
| Pince pour l'os marteau, House-Dieter .....                              | 657              | Pincettes coupantes à os, Ruskin-Liston .....               | 532      | Porte-aiguilles, Hegar-Vascular .....                                       | 425           |
| Pince pour la cloison nasale .....                                       | 670              | Pincettes coupantes à os, Stille-Liston .....               | 532-533  | Porte-aiguilles, Jameson .....  | 412           |
| Pince pour la cloison nasale .....                                       | 687              | Pincettes coupantes à os, Stille-Liston .....               | 532-533  | Porte-aiguilles, Johnson .....  | 413           |
| Pince pour la cloison nasale, Brünings .....                             | 687              | Pincettes pour amygdales, Blohmke .....                     | 729      | Porte-aiguilles, Kilner .....   | 419           |
| Pince pour la cloison nasale, Caplan .....                               | 694              | Pincettes pour amygdales, Blohmke .....                     | 729      | Porte-aiguilles, Kübler .....   | 430           |
| Pince pour la cloison nasale, Graig .....                                | 687              | Pincettes pour amygdales, Schmid .....                      | 729      | Porte-aiguilles, Langenbeck .....   | 430           |
| Pince pour la cloison nasale, Knight .....                               | 687              | Pincettes pour amygdales, White .....                       | 729      | Porte-aiguilles, M. G. Hospital .....                                       | 411           |
| Pince pour la cloison nasale, Kressner .....                             | 718              | Pincettes pour biopsie rectale .....                        | 582      | Porte-aiguilles, Martin .....   | 423           |
| Pince pour la cloison nasale, Middleton-Jansen .....                     | 694              | Pincettes pour couper ongles .....                          | 745      | Porte-aiguilles, Martini .....  | 426-427       |
| Pince pour le col de l'utérus .....                                      | 622              | Pincettes pour couper ongles .....                          | 744      | Porte-aiguilles, Masson .....   | 412, 422      |
| Pince pour le col de l'utérus, Braun .....                               | 619, 622         | Pincettes pour entrelacer les tendons .....                 | 510      | Porte-aiguilles, Mathieu .....  | 414, 428-429  |
| Pince pour le col de l'utérus, Czerny .....                              | 622              | Pincettes pour passer les tendons .....                     | 509      | Porte-aiguilles, Mayo-Hegar .....   | 411, 421      |
| Pince pour le col de l'utérus, Duplay .....                              | 619              | Pincettes pour passer les tendons .....                     | 509      | Porte-aiguilles, Metzenbaum .....   | 410           |
| Pince pour le col de l'utérus, Iowa .....                                | 621              | Pincettes pour passer les tendons, Brand .....              | 509      | Porte-aiguilles, Microvascular .....  | 426           |
| Pince pour le col de l'utérus, Jacobs .....                              | 621              | Pincettes pour saisir les tendons .....                     | 510      | Porte-aiguilles, Neivert .....  | 409           |
| Pince pour le col de l'utérus, Mauseux .....                             | 621              | Pincettes pour saisir les tendons, Carroll .....            | 509      | Porte-aiguilles, Olsen Hegar .....  | 414, 427      |
| Pince pour le col de l'utérus, Schröder .....                            | 619-620          | Pincettes pour saisir les tendons, Kleinert-Kutz .....      | 510      | Porte-aiguilles, Par-Style .....  | 416           |
| Pince pour le col de l'utérus, Skene .....                               | 620              | Pincettes pour saisir les tendons, Steinmann .....          | 509      | Porte-aiguilles, Ryder (Martin) .....                                       | 423           |
| Pince pour le col de l'utérus, Teale .....                               | 620              | Pincettes-clamps pour hémorroïdes, McGinvey .....           | 582      | Porte-aiguilles, Ryder-Vascular .....                                       | 424           |
| Pince pour le col de l'utérus, Faure .....                               | 210              | Pincettes-gouges .....                                      | 524      | Porte-aiguilles, Sarot .....  | 421           |
| Pince pour le péritoine, Mikulicz .....                                  | 209-210          | Pincettes-gouges, Beyer .....                               | 525      | Porte-aiguilles, Stratte .....  | 413, 426      |
| Pince pour le péritoine, Mikulicz-Baby .....                             | 209              | Pincettes-gouges, Blumenthal .....                          | 524      | Porte-aiguilles, Toennis .....  | 429           |
| Pince pour le redressement de la<br>cloison nasale, Asch .....           | 718              | Pincettes-gouges, Böhler .....                              | 525      | Porte-aiguilles, Wangenstein .....  | 413, 424      |
| Pince pour le redressement de la<br>cloison nasale, Cottle-Walsham ..... | 718              | Pincettes-gouges, Cleveland .....                           | 522      | Porte-aiguilles, Webster .....  | 409, 415, 419 |
| Pince pour les calculs du bassin, Heiming .....                          | 584              | Pincettes-gouges, Echlin .....                              | 527      | Porte-clamps, De Martel-Wolfson .....                                       | 567           |
| Pince pour les calculs du bassin, Randall .....                          | 584              | Pincettes-gouges, Friedmann .....                           | 522      | Porte-coton, Farrell .....  | 355           |
| Pince pour les voies biliaires, Desjardins .....                         | 201              | Pincettes-gouges, Frykholm .....                            | 528      | Porte-ligature, Modell Wien .....   | 438           |
| Pince pour les voies biliaires, Lahey .....                              | 198              | Pincettes-gouges, Hartmann .....                            | 523      | Porte-tampon, Luniatzschek .....  | 728           |
| Pince pour pénis, Stockmann .....  | 598              | Pincettes-gouges, Jansen .....                              | 523      | Potts-Smith, Ciseaux vasculaires .....                                      | 74-75         |
|  |                  | Pincettes-gouges, Leksell-Stille .....                      | 528      | Potts-Smith, Pince à dissection .....                                       | 130, 133      |
|  |                  | Pincettes-gouges, Lempert .....                             | 523      | Potts-Smith, Pince à dissection à griffes .....                             | 142           |

- Pousse-fil ..... 438  
 Pratt, Spéculum rectal ..... 579  
 Providence-Hospital, Pince hémostatique ..... 173  
 Putti, Râpe pour os ..... 473
- Q**  
 Quattro, Pince pour plâtre ..... 448  
 Quervain, Élévateur ..... 501
- R**  
 Raccord ..... 385  
 Raccord pour tubes ..... 385  
 Ragnell-Davis, Crochet ..... 231  
 Ragnell, Ciseaux à dissection ..... 123  
 Rampley, Pince pour éponges ..... 223  
 Randall, Pince pour les calculs du bassin ..... 584  
 Râpe nasale, Cottle ..... 711  
 Râpe nasale, Fomon ..... 712, 714  
 Râpe nasale, Lewis ..... 712  
 Râpe nasale, Maltz ..... 711, 713  
 Râpe pour la glabelle, Aufricht ..... 712  
 Râpe pour os, Putti ..... 473  
 Raspoir pour palais, Krenkel ..... 701  
 Rasse, Ecarteur à os ..... 226  
 Rasse, Micro Crochet ..... 226  
 Recarnier, Curette utérine ..... 634  
 Récipient en métal ..... 759  
 Redon, Aiguille d'introduction ..... 379-380  
 Rees, Ciseaux pour Face-lift ..... 119  
 Ricard, Ecarteur, Hartmann ..... 668  
 Resano, Pince à dissection à griffes ..... 147  
 Resano, Pince pour anastomose rectale ..... 578  
 Retracteur pour amputation, Percy ..... 521  
 Reynolds, Ciseaux à dissection ..... 67-68  
 Ricard, Ecarteur abdominal ..... 307  
 Ricard, Ecarteur, seul ..... 307  
 Ricard, Valve centrale ..... 307  
 Richardson-Eastman, Ecarteur ..... 252  
 Richardson, Ecarteur ..... 253  
 Richardson, marTract ..... 342  
 Richter, Pince à poser les agrafes ..... 440  
 Ritter-Halle, Dilatateur pour le sinus frontal ..... 720  
 Roberts, Pince à disséquer et à ligatures ..... 187  
 Robinet ..... 385  
 Robinet à trois voies ..... 385  
 Rochester-Carmalt, Pince hémostatique ..... 177  
 Roeder, Pince à champs ..... 212  
 Roger, Élévateur pour le périoste ..... 704  
 Rogers, Pince à hystérectomie ..... 206  
 Rose, Ecarteur pour trachéotomie ..... 549  
 Rosen, Couteau circulaire ..... 659  
 Rosen, Micro Aiguille auriculaire ..... 660  
 Rosen, Micro Rugine-Raspoir auriculaire ..... 662  
 Ross, Ecarteur pour aorta ..... 265  
 Roux-Baby, Ecarteur ..... 277  
 Roux-Mini, Ecarteur ..... 277  
 Roux, Ecarteur ..... 276  
 Roux, marTract ..... 344  
 Rubin, Capuchon protecteur ..... 695  
 Rubin, Ostéotome ..... 707  
 Rubin, Pince-gouge pour la cloison nasale ..... 695  
 Rugine pour le périoste costal, Doyen ..... 495  
 Rugine-raspoir ..... 493-494  
 Rugine-raspoir à succion, Guilen ..... 720  
 Rugine-raspoir auriculaire, Lempert ..... 679  
 Rugine-raspoir, Alexander ..... 496  
 Rugine-raspoir, Cobb ..... 492  
 Rugine-raspoir, Cottle ..... 490  
 Rugine-raspoir, Farabeuf ..... 491  
 Rugine-raspoir, Farabeuf-Collin ..... 491  
 Rugine-raspoir, Kahre-Williger ..... 494  
 Rugine-raspoir, Key ..... 491  
 Rugine-raspoir, König ..... 490  
 Rugine-raspoir, Lambotte ..... 496  
 Rugine-raspoir, Landolt ..... 490  
 Rugine-raspoir, Langenbeck ..... 490  
 Rugine-raspoir, Martin-Cushing ..... 489  
 Rugine-raspoir, Martin-Hoen ..... 488  
 Rugine-raspoir, Martin-Langenbeck ..... 488  
 Rugine-raspoir, Sedillot ..... 490  
 Rugine-raspoir, Semb ..... 496  
 Rugine-raspoir, Williger ..... 494  
 Raigne Raspoir Palatal ..... 726  
 Rumel, Pince à disséquer et à ligatures ..... 193  
 Ruskin-Liston, Pincés coupantes à os ..... 532  
 Ruskin, Pincés-gouges ..... 526  
 Russ, Modell, Pince à dissection à griffes ..... 145  
 Rydel-Seiffert, Curseur ..... 669  
 Rydel-Seiffert, Diapason ..... 669
- Rydel-Seiffert, Poids ..... 669  
 Rydel-Seiffert, Vis moléée ..... 669  
 Ryder (Martin), Porte-aiguilles ..... 423  
 Ryder-Vascular, Porte-aiguilles ..... 424
- S**  
 Salyer, Ciseaux à dissection ..... 59, 107  
 Salyer, Ciseaux pour Face-lift ..... 107  
 Salyer, Crochet pour palais ..... 726  
 Salyer, Dissecteur pour palais ..... 726  
 Salyer, Élévateur pour palais ..... 726  
 Sängner, Pince placentaire et pour poste-abortion ..... 640  
 Sanvenero, Ciseaux chirurgicaux ..... 59  
 Sarot, Pince à disséquer et à ligatures ..... 187  
 Sarot, Porte-aiguilles ..... 421  
 Satinsky, Ciseaux vasculaires ..... 71  
 Sauerbruch, Boîte pour aiguilles ..... 751  
 Sauerbruch, Ecarteur ..... 264  
 Sauerbruch, Pince pour déchets ..... 768  
 Scalp-Contour, Ecarteur autostatique ..... 282  
 Schädel, Pince à champs ..... 211  
 Schede, Curette tranchante ..... 482  
 Scheibe, Pince pour saisir organes ..... 570  
 Scherbak, Manche pour spéculum vaginal ..... 609, 610  
 Scherbak, Poids pour spéculum vaginal ..... 610  
 Scherbak, Spéculum vaginal ..... 610  
 Scherbak, Valve vaginale, seule ..... 609  
 Schink, Dermotome ..... 14  
 Schink, Lame de rechange ..... 14  
 Schink, Plaque pour tendre la peau ..... 14  
 Schmid, Canule pour irrigation vasculaire ..... 384  
 Schmieden-Dick, Aiguilles à ligatures ..... 431  
 Schmieden-Payr, Sondes conductrices ..... 436  
 Schmieden-Taylor, Ciseaux vasculaires ..... 77  
 Schmieden, Aiguilles à ligatures ..... 431  
 Schmieden, Sondes conductrices ..... 436  
 Schmidt, Pince à disséquer et à ligatures ..... 177  
 Schmidt, Pincés pour amygdales ..... 729  
 Schröder, Curette utérine ..... 633  
 Schröder, Pince pour le col de l'utérus ..... 619-620  
 Schubert, Pince pour biopsie ..... 628-629  
 Schuhmacher, Ciseaux pour le cordon ombilical ..... 90  
 Schuknecht, Synéchiotome ..... 659  
 Schumacher, Embout, seul ..... 632  
 Schumacher, Pince pour biopsie ..... 632  
 Schweden-Modell, Pince à dissection ..... 128  
 Scie nasale, Joseph ..... 709  
 Scie oscillante ..... 450  
 Scoville-Haverfield, Ecarteur pour laminectomie ..... 320  
 Scoville, Curette tranchante ..... 484  
 Scoville, Ecarteur pour laminectomie ..... 320  
 Scoville, Valve ..... 321  
 Scoville, Valve ..... 321  
 Scudder, Pince intestinale ..... 575  
 Seau pour déchets ..... 768  
 Sebileau, Élévateur ..... 501  
 Sedillot, Rugine-raspoir ..... 490  
 Segond, Evidur de fibromes ..... 624  
 Seiffert, Embout interchangeable ..... 732  
 Sellheim, Levier obstétrique ..... 640  
 Semb, Davier porte-os ..... 515  
 Semb, Pincés-gouges ..... 526  
 Semb, Rugine-raspoir ..... 496  
 Semken, Pince à dissection ..... 129  
 Semken, Pince à dissection à griffes ..... 131, 140  
 Semm, Spéculum vaginal ..... 601  
 Senn-Green, Crochet ..... 231  
 Senn-Miller, Crochet ..... 231  
 Serre-noeuds ..... 670, 684, 730  
 Serre-noeuds pour amygdales, Brünings ..... 730  
 Serre-noeuds pour amygdales, Eves ..... 730  
 Serre-noeuds pour amygdales, Tyding ..... 730  
 Serre-noeuds, Krause-Voss ..... 670, 684  
 Shambaugh, Micro Aiguille auriculaire ..... 662  
 Shapleigh, Curette auriculaire ..... 676  
 Shea Vein Graft, Ciseaux à dissection ..... 64  
 Shea, Crochet à exploration ..... 662  
 Siegert, Ciseaux fins à dissection ..... 117  
 Silver, Ciseau-burin nasal ..... 708  
 Silver, Dermotome ..... 14  
 Silver, Lame de rechange ..... 14  
 Simon, Crochet pour fistules ..... 626  
 Simon, Curette tranchante ..... 484  
 Simon, Curette utérine ..... 633  
 Simon, Ecarteur ..... 259  
 Simpson, Forceps obstétrique ..... 638  
 Sims-Siebold, Ciseaux à gynécologie ..... 35
- Sims, Ciseaux à gynécologie ..... 30-31  
 Sims, Curette utérine ..... 634  
 Sims, Hystéromètre ..... 618  
 Sims, Spéculum rectal ..... 579  
 Sims, Spéculum vaginal ..... 602  
 Singley-Tuttle, Pince à dissection à griffes ..... 146  
 Skene, Pince pour le col de l'utérus ..... 620  
 Smith-Petersen, Ostéotome ..... 469  
 Socle, Lucae ..... 668  
 Somer, Pince hystérolabe ..... 625  
 Sonde auriculaire, Hartmann ..... 670  
 Sonde auriculaire, Krause ..... 670, 684  
 Sonde boutonnée ..... 350  
 Sonde boutonnée, Stacke ..... 350  
 Sonde cannelée ..... 351  
 Sonde cannelée, Doyen ..... 351  
 Sonde cannelée, Nelaton ..... 351  
 Sonde conductrice pour tendons, Bunnell ..... 508  
 Sonde feuille de myrte ..... 350  
 Sonde, Bowman ..... 645  
 Sondes conductrices, Brunner ..... 435  
 Sondes conductrices, König ..... 437  
 Sondes conductrices, Mod. Martin ..... 436  
 Sondes conductrices, Payr ..... 438  
 Sondes conductrices, Schmieden ..... 436  
 Sondes conductrices, Schmieden-Payr ..... 436  
 Sondes métalliques, pour femmes ..... 595  
 Spatule à goitre, Kocher ..... 550  
 Spatule à laryngoscopie (lumière froide), Foregger ..... 397  
 Spatule à laryngoscopie (lumière froide), McIntosh ..... 394-395  
 Spatule à laryngoscopie (lumière froide), Miller ..... 398-399  
 Spatule à laryngoscopie, Foregger ..... 392-393  
 Spatule à laryngoscopie, Guedel-Negus ..... 390  
 Spatule à laryngoscopie, McIntosh ..... 391  
 Spatule à laryngoscopie, Miller ..... 389  
 Spatule abdominale ..... 348  
 Spatule abdominale, Haberer ..... 348  
 Spatule abdominale, Kader ..... 275  
 Spatule abdominale, Kummel ..... 275  
 Spatule abdominale, Martin ..... 348  
 Spécula auriculaires (jeu), Hartmann ..... 664  
 Spécula auriculaires, jeu, Toynebee ..... 664  
 Spécula auriculaires, Toynebee ..... 664  
 Spéculum auriculaire, Farrior ..... 665  
 Spéculum auriculaire, Hartmann ..... 664  
 Spéculum nasal, Cottle ..... 682-683  
 Spéculum nasal, Goldsmith (Thudichum) ..... 680  
 Spéculum nasal, Hartmann-Halle ..... 680  
 Spéculum nasal, Killian ..... 681  
 Spéculum nasal, Martin ..... 681  
 Spéculum nasal, Mod. Wien ..... 682  
 Spéculum nasal, Tieck-Halle ..... 681  
 Spéculum rectal, Czerny ..... 579  
 Spéculum rectal, Pratt ..... 579  
 Spéculum rectal, Sims ..... 579  
 Spéculum vaginal, Auvard ..... 611  
 Spéculum vaginal, Breisky ..... 612  
 Spéculum vaginal, Collin ..... 600  
 Spéculum vaginal, Cosco ..... 600  
 Spéculum vaginal, Doyen ..... 608  
 Spéculum vaginal, Grave ..... 601  
 Spéculum vaginal, Guttman ..... 601  
 Spéculum vaginal, Jackson ..... 602  
 Spéculum vaginal, Kallmorgen ..... 607  
 Spéculum vaginal, Kristeller ..... 603-606  
 Spéculum vaginal, Kristeller ..... 603-606  
 Spéculum vaginal, Pederson ..... 601  
 Spéculum vaginal, Scherbak ..... 610  
 Spéculum vaginal, Semm ..... 601  
 Spéculum vaginal, Sims ..... 602  
 Spéculum vaginal, Weissbarth ..... 612  
 Spencer-Wells, Pince hémostatique ..... 167  
 Spencer, Ciseaux à ligatures ..... 108  
 Sphinctroscope, Kelly ..... 581  
 Spratt, Curette tranchante ..... 483  
 St. Marks, Ecarteur pour pelvis ..... 274  
 St. Marks, marTract ..... 343  
 Stacke, Sonde boutonnée ..... 350  
 Steinmann, Pincés pour saisir les tendons ..... 509  
 Stellbrink, Pincés-gouges ..... 522  
 Stevens, Ciseaux à iridectomie ..... 101-102  
 Stieglitz, Pince à échardes ..... 156  
 Stille-Barraya, Pince à dissection à griffes ..... 145  
 Stille-Liston, Pincés coupantes à os ..... 532-533  
 Stille-Luer, Pincés-gouges ..... 529  
 Stille-Martin, Ciseaux pour plâtre ..... 445

# Index alphabétique

## Français

|   |              |  |               |                                      |     |
|---|--------------|--|---------------|--------------------------------------|-----|
| Stille-Martin, Lame de rechange .....                                       | 445          | Valve laterale, Alan-Parks .....                         | 580           | Zielke, Gouge .....                  | 459 |
| Stille-Ruskin, Pincés-gouges .....  | 527          | Valve laterale, Millin .....                             | 593           | Zoellner, Canules d'aspiration ..... | 368 |
| Stille, Ciseau-burin .....  | 460          | Valve vaginale, Doyen .....                              | 612           | Zoellner, Pointe de succion .....    | 368 |
| Stille, Gouge .....   | 461          | Valve vaginale, Kallmorgen .....                         | 607           |                                      |     |
| Stille, Ostéotome .....   | 460-461      | Valve vaginale, seule, Scherbak .....                    | 609           |                                      |     |
| Stille, Pince à dissection à griffes .....                                  | 139          | Valve, Cloward .....                                     | 296-297       |                                      |     |
| Stille, Pincés-gouges .....   | 526          | Valve, Kirschner .....                                   | 317-319       |                                      |     |
| Stockmann, Pince pour pénis .....   | 598          | Valve, Scoville .....                                    | 321           |                                      |     |
| Strandell-Stille, Crochet .....   | 234          | Valve, Scoville .....                                    | 321           |                                      |     |
| Stratte, Porte-aiguilles .....  | 413, 426     | Van Buren, Bougie urétrale .....                         | 594           |                                      |     |
| Strauss, paire de tubes flexibles, seuls .....                              | 598          | Van Doren, Pince pour biopsie .....                      | 630           |                                      |     |
| Strauss, Pince pour pénis .....   | 598          | Vanne d'aspiration, Cerullo .....                        | 370           |                                      |     |
| Stripper à anneau, Vollmar .....  | 354          | Varady, Dissecteur pour phlébite .....                   | 352           |                                      |     |
| Strully, Ciseaux pour neurochirurgie .....                                  | 77           | Varady, Extracteur pour phlébite .....                   | 352           |                                      |     |
| Strümpel, Pince pour polypes auriculaires .....                             | 673          | Varady, Extracteur pour phlébite micro .....             | 352           |                                      |     |
| Struycken, Pince nasale coupante .....                                      | 691          | Varady, Extracteur pour phlébite mini .....              | 352           |                                      |     |
| Support pour spécula auriculaires .....                                     | 665          | Varady, Micro dissecteur .....                           | 352           |                                      |     |
| Synéchiotome, Schuknecht .....  | 659          | Veidenheimer, Pince pour anastomose rectale .....        | 577           |                                      |     |
| Synéchiotome, Wullstein .....   | 659          | Verbrugge, Davier porte-os .....                         | 520-521       |                                      |     |
| Système Bras Martin, Martin .....   | 322          | Verre de rechange .....                                  | 743           |                                      |     |
| Système d'ecarteurs, Martin-Rochard .....                                   | 323          | Virchow, Couteaux .....                                  | 3             |                                      |     |
|   |              | Vis .....  | 508           |                                      |     |
| <b>T</b>  |              | Vis de rechange .....                                    | 462           |                                      |     |
| Tabb, Couteau pour muqueuse .....   | 659          | Vis moletée, Rydel-Seiffert .....                        | 669           |                                      |     |
| Takahashi, Pince éthmoïdale .....   | 688          | Volkman, Curette double .....                            | 486           |                                      |     |
| Tamis pour spéculum vaginal, Weissbarth .....                               | 612          | Volkman, Curette tranchante .....                        | 481-482       |                                      |     |
| Taylor, Ecarteurs spinaux .....   | 507          | Volkman, Ecarteurs .....                                 | 236-238       |                                      |     |
| Taylor, Pince à dissection .....  | 129          | Volkman, marTract .....                                  | 344           |                                      |     |
| Taylor, Pince à dissection à griffes .....                                  | 141          | Vollmar, Stripper à anneau .....                         | 354           |                                      |     |
| Teale, Pince pour le col de l'utérus .....                                  | 620          |  |               |                                      |     |
| Thoms-Allis, Pince pour saisir intestins et tissus .....                    | 557          | <b>W</b>   |               |                                      |     |
| Thoms-Gaylor, Pince pour biopsie .....                                      | 629          | Wachenfeldt, Pince à poser les agrafes .....             | 439           |                                      |     |
| Thorek, Ciseaux à dissection .....  | 50           | Wagener, Crochet auriculaire .....                       | 678           |                                      |     |
| Tieck-Halle, Spéculum nasal .....   | 681          | Wagner, Ciseaux chirurgicaux .....                       | 92            |                                      |     |
| Toennis-Adson, Ciseaux fins à dissection .....                              | 78, 113      | Waldmann, Ciseaux à épisiotomie .....                    | 89            |                                      |     |
| Toennis, Porte-aiguilles .....  | 429          | Walter, Gouge .....                                      | 707           |                                      |     |
| Tohoku, Pince à champs .....  | 212          | Walter, Ostéotome .....                                  | 707           |                                      |     |
| Toynbee, Spécula auriculaires .....   | 664          | Wangensteen, Pince à dissection .....                    | 134           |                                      |     |
| Tracteur pour myomes, Doyen .....   | 624          | Wangensteen, Porte-aiguilles .....                       | 413, 424      |                                      |     |
| Travers, Ecarteur autostatique .....  | 283          | Wassmund, Ecarteur .....                                 | 241           |                                      |     |
| Tröltzsch (Wilde), Pince auriculaire .....                                  | 671          | Watson-Williams, Pince éthmoïdale .....                  | 689           |                                      |     |
| Tröltzsch, Pince à pansements .....   | 686          | Waugh, Pince à dissection .....                          | 128           |                                      |     |
| Trousse à varices, Nabatoff .....   | 353          | Waugh, Pince à dissection à griffes .....                | 140           |                                      |     |
| Trousse pour laryngoscopes .....  | 393          | Weber-Loch, Curette / crochet auriculaire .....          | 677           |                                      |     |
| Trousseau, Dilatateur pour la trachéotomie .....                            | 548          | Webster, Porte-aiguilles .....                           | 409, 415, 419 |                                      |     |
| Troutman-Chris, Pincette pour saisir<br>et casser les lames de rasoir ..... | 4            | Weil-Blakesley, Pince éthmoïdale .....                   | 690           |                                      |     |
| Tube d'aspiration, Baby-Poole .....   | 373          | Weil-Blakesley, Pince nasale coupante .....              | 690           |                                      |     |
| Tube d'aspiration, Baby-Yankauer .....                                      | 371          | Weil, Pince nasale coupante .....                        | 689           |                                      |     |
| Tube d'aspiration, Baron-Schuknecht .....                                   | 369          | Weissbarth, Spéculum vaginal .....                       | 612           |                                      |     |
| Tube d'aspiration, Byrd .....   | 378          | Weissbarth, Tamis pour spéculum vaginal .....            | 612           |                                      |     |
| Tube d'aspiration, Cogswell .....   | 378          | Weitlaner-Baby, Ecarteur autostatique .....              | 292           |                                      |     |
| Tube d'aspiration, Cooley .....   | 375          | Weitlaner-Wullstein, Ecarteur autostatique .....         | 289           |                                      |     |
| Tube d'aspiration, De Bakey-Adson .....                                     | 371          | Weitlaner, Ecarteur autostatique .....                   | 284, 287-288  |                                      |     |
| Tube d'aspiration, House .....  | 374          | Wertheim-Cullen, Pince vaginale .....                    | 205           |                                      |     |
| Tube d'aspiration, Jamieson .....   | 377          | Wertheim, Ciseaux à gynécologie .....                    | 36            |                                      |     |
| Tube d'aspiration, Luer .....   | 369          | Wertheim, Pince à hystérectomie .....                    | 208           |                                      |     |
| Tube d'aspiration, Nuboer .....   | 377          | Westcott, Ciseaux à strabisme .....                      | 103           |                                      |     |
| Tube d'aspiration, Poole .....  | 373          | Westmacott, Pince à pansements .....                     | 686           |                                      |     |
| Tube d'aspiration, Yankauer .....   | 371-372      | White, Pincés pour amygdales .....                       | 729           |                                      |     |
| Tube d'aspiration, Yankauer .....   | 372          | Wikstroem, Pince à disséquer et à ligatures .....        | 196           |                                      |     |
| Tube d'aspiration, Yasargil .....   | 370          | Williams, Ecarteur autostatique .....                    | 291           |                                      |     |
| Tube laryngien, Brünings .....  | 732          | Williams, Pince pour saisir intestins et tissus .....    | 558           |                                      |     |
| Tube rallonge, Brünings .....   | 632          | Williger, Curette double .....                           | 487           |                                      |     |
| Tuffier, Pince hémostatique .....   | 168          | Williger, Élévateur .....                                | 501           |                                      |     |
| Tuohy, Aiguille pour ponction lombaire .....                                | 382          | Williger, Maillet .....                                  | 475, 477      |                                      |     |
| Tyding, Serre-noeuds pour amygdales .....                                   | 730          | Williger, Ruggine-raspatoire .....                       | 494           |                                      |     |
|   |              | Winter, Pince placentaire et<br>pour poste-abortum ..... | 640           |                                      |     |
| <b>U</b>  |              | Wolff, Pince pour rompre plâtre .....                    | 449           |                                      |     |
| Ulrich, Davier porte-os .....   | 517          | Wrigley, Forceps obstétrique .....                       | 638           |                                      |     |
| Ulrich, Pince à tampons .....   | 218          | Wullstein, Canules d'aspiration .....                    | 368           |                                      |     |
| Universal, Ciseaux coupe-fil .....  | 109          | Wullstein, Micro Ciseaux auriculaires .....              | 655           |                                      |     |
| Universal, Ciseaux pour pansements .....                                    | 444          | Wullstein, Pointe de succion .....                       | 368           |                                      |     |
| Uro-Tangential, Pince tangentielle .....                                    | 199          | Wullstein, Synéchiotome .....                            | 659           |                                      |     |
|   |              |  |               |                                      |     |
| <b>V</b>  |              | <b>Y</b>   |               |                                      |     |
| Valleix, Hystéromètre .....   | 618          | Yankauer, Manche .....                                   | 372           |                                      |     |
| Valve centrale, Alan-Parks .....  | 580          | Yankauer, Olive .....                                    | 372           |                                      |     |
| Valve centrale, Balfour .....   | 313          | Yankauer, Pointe de succion .....                        | 372           |                                      |     |
| Valve centrale, Balfour-Standard .....                                      | 312, 314-315 | Yankauer, Tube d'aspiration .....                        | 371-372       |                                      |     |
| Valve centrale, Collin .....  | 305-306      | Yankauer, Tube d'aspiration .....                        | 372           |                                      |     |
| Valve centrale, Gosset .....  | 310          | Yasargil, Tube d'aspiration .....                        | 370           |                                      |     |
| Valve centrale, Henley .....  | 293          | Young, Ecarteur prostatiques .....                       | 589           |                                      |     |
| Valve centrale, Low-Profile .....   | 302          |  |               |                                      |     |
| Valve centrale, Millin .....  | 593          | <b>Z</b>   |               |                                      |     |
| Valve centrale, O'Sullivan-O'Connor .....                                   | 316          | Zaufal-Jansen, Pincés-gouges .....                       | 525           |                                      |     |
| Valve centrale, Ricard .....  | 307          | Zaufal, Levier pour corps étrangers .....                | 677           |                                      |     |
| Valve en fil, Balfour, Mod. USA .....                                       | 315          | Zenker, Ecarteur .....                                   | 250           |                                      |     |
| Valve laterale .....  | 304-309      | Zenker, Pince à disséquer et à ligatures .....           | 194           |                                      |     |

Indice, alfabetico  
**Italiano**



|  |                   |  |              |
|--|-------------------|--|--------------|
| <b>A</b>   |                   |  |              |
| Adattatore di aspirazione, House .....                     | 374               | Beckmann, Divaricatore automatico .....                                  | 298          |
| Adattatore per cateteri .....                              | 385               | Beebee, Forbici per tagliare fili metallici .....                        | 110          |
| Adlerkreutz, Pinza per dissezione con denti .....          | 139               | Beer, Pinza depilatoria .....  | 155          |
| Adson-Baby, Pinza per preparazione e legature .....        | 186               | Bellucci, Micro Forbici auricolare .....                                 | 654          |
| Adson-Brown, Pinza per dissezione<br>con denti .....       | 132, 142          | Bengolea, Pinza emostatica .....   | 180          |
| Adson, Cannula d' aspirazione .....                        | 364               | Bennett, Elevatore per ossa .....  | 506          |
| Adson, Divaricatore automatico .....                       | 285, 294-295, 298 | Benson, Divaricatore pilorio .....                                       | 567          |
| Adson, Elevatore .....                                     | 498               | Bergmann, Forbici per gesso .....  | 443          |
| Adson, Pinza per dissezione .....                          | 128, 132          | Bergmann, Pinza per tamponi e spunge .....                               | 222          |
| Adson, Pinza per dissezione con denti .....                | 132, 140          | Bernhard, Pinza fissatili .....  | 212          |
| Adson, Pinza per preparazione e legature .....             | 177               | Beyer, Pinza osteotomo .....   | 675          |
| Adson, Portaghi .....                                      | 410               | Beyer, Pinza-sgorbia .....   | 525          |
| Ago chirurgici .....                                       | 403               | Biemer-Müller, Approssimatore .....                                      | 159          |
| Ago chirurgico .....                                       | 402               | Biemer, Clip vascolare .....   | 158          |
| Ago conduttore, Redon .....                                | 379-380           | Biemer, Micro-Forbici .....  | 105          |
| Ago per eparina .....                                      | 381               | Billeau, Ansa auricolare .....   | 677          |
| Ago per eparina, Mock .....                                | 381, 384          | Bircher-Ganske, Pinza per cartilagine .....                              | 511          |
| Ago per legatura .....                                     | 432               | Bisturi per dissezione .....   | 2            |
| Ago per legatura, Brunner .....                            | 435               | Bisturi per fibromi, Segond .....  | 624          |
| Ago per legatura, Cooper .....                             | 432               | Bisturi per il setto nasale, Ballenger .....                             | 700          |
| Ago per legatura, Deschamps .....                          | 433-434           | Bisturi per il setto nasale, Freer .....                                 | 700          |
| Ago per legatura, Kronecker .....                          | 432               | Bisturi per mucosa, Freer .....  | 700          |
| Ago per legatura, Schmieden .....                          | 431               | Bisturi per mucosa, Tabb .....   | 659          |
| Ago per legatura, Schmieden-Dick .....                     | 431               | Bisturi per plastica nasale, Converse .....                              | 699          |
| Ago per timpano, Lucae .....                               | 678               | Bisturi per plastica nasale, Cottle .....                                | 699          |
| Ago per timpano, Politzer .....                            | 678               | Bisturi per plastica nasale, Fomon .....                                 | 699          |
| Alan-Parks, Dilatatore rettale .....                       | 580               | Bisturi per plastica nasale, Joseph .....                                | 699          |
| Alan-Parks, Madrevite ad alette .....                      | 580               | Bisturi per tonsille, Brünings .....                                     | 727          |
| Alan-Parks, marTract .....                                 | 338               | Bisturi per tonsille, Fisher .....                                       | 727          |
| Alan-Parks, Valva centrale .....                           | 580               | Bisturi per uso unico .....  | 11-12        |
| Alan-Parks, Valva laterale .....                           | 580               | Blake, Curetta uterina .....   | 633          |
| Alderdyce, Dissettore doppio .....                         | 501               | Blake, Pinza per calcoli biliari .....                                   | 586          |
| Alexander, Periostotomo .....                              | 496               | Blohmke, Pinza per tonsille .....  | 729          |
| Alexander, Pinza per biopsia .....                         | 631               | Blount, Divaricatore per il ginocchio .....                              | 507          |
| Alexander, Scalpello .....                                 | 459               | Blount, Divaricatore per il ginocchio .....                              | 507          |
| Alexander, Sgorbia .....                                   | 459               | Blumenthal, Pinza-sgorbia .....  | 524          |
| Allen, Pinza intestinale .....                             | 564               | Böhler, Cesioia per ossa .....   | 531          |
| Allis-Adair, Pinza per afferrare intestino e tessuti ..... | 557               | Böhler, Pinza-sgorbia .....  | 525          |
| Allis-Baby, Pinza per afferrare intestino e tessuti .....  | 556               | Bonney, Pinza per dissezione .....                                       | 127          |
| Allis, Pinza per afferrare intestino e tessuti .....       | 556-557           | Bonney, Pinza per dissezione con denti .....                             | 131, 146     |
| Alm, Divaricatore automatico .....                         | 281               | Borowski, Divaricatore per aorta .....                                   | 266          |
| Amniotomo, Beacham .....                                   | 619               | Bottone di ricambio, Lucae .....   | 668          |
| Anderson-Adson, Divaricatore automatico .....              | 282               | Bowman, Sonda .....  | 645          |
| Ansa auricolare, Billeau .....                             | 677               | Boys-Allis, Pinza per afferrare intestino e tessuti .....                | 557          |
| Ansa auricolare, Weber-Loch .....                          | 677               | Bozemann, Portaghi .....   | 425          |
| Anuscopio, Ives-Fansler .....                              | 579               | Brand, Pinza passa-tendini .....   | 509          |
| Appoggiapiedi, Hartmann .....                              | 668               | Braun-Stadler, Forbici per episiotomia .....                             | 89           |
| Approssimatore .....                                       | 160               | Braun, Depressore uterino .....  | 618          |
| Approssimatore, Biemer-Müller .....                        | 159               | Braun, Pinza per il collo dell'utero .....                               | 619, 622     |
| Asch, Pinza per raddizzare il setto nasale .....           | 718               | Breisky, marTract .....  | 340          |
| Aston, Forbici per Face-lift .....                         | 45                | Breisky, Specolo vaginale .....  | 612          |
| Aufricht, Divaricatore nasale .....                        | 715, 717          | Brom, Divaricatore per veni .....  | 234          |
| Aufricht, Raspa per glabella .....                         | 712               | Brompton, Pinza con rotelle .....  | 215          |
| Austin, Dissettore per l'attico .....                      | 662               | Brown, Portaghi .....  | 410          |
| Auvard, Peso per specolo vaginale .....                    | 611               | Brünings, Bisturi per tonsille .....                                     | 727          |
| Auvard, Specolo vaginale .....                             | 611               | Brünings, Laccio .....   | 730          |
|  |                   | Brünings, Pinza intercambiabile<br>per bronco-esofagoscopia .....        | 732-733      |
| <b>B</b>   |                   | Brünings, Pinza per il setto nasale .....                                | 687          |
| Babcock, Pinza per afferrare intestino<br>e tessuti .....  | 558-559           | Brünings, Serranodi per tonsille .....                                   | 730          |
| Baby-Adson, Pinza per preparazione e legature .....        | 170               | Brünings, Tubo allunghi .....  | 632          |
| Baby-Poole, Tubo di aspirazione .....                      | 373               | Brünings, Tubo laringeo .....  | 732          |
| Baby-Yankauer, Tubo di aspirazione .....                   | 371               | Brunner, Ago per legatura .....  | 435          |
| Bacinella reniforme .....                                  | 760               | Brunner, Divaricatore .....  | 262-263      |
| Backhaus, Pinza fissatili .....                            | 211               | Brunner, Pinza per anastomosi retali .....                               | 575          |
| Bakes, Dilatatore per condotti biliari .....               | 585               | Brunner, Sonda conduttrice .....   | 435          |
| Balfour-Baby, Divaricatore addominale .....                | 311               | Bruns, Curetta tagliente .....   | 483-484      |
| Balfour-Standard, Divaricatore addominale .....            | 314               | Bruns, Forbici per gesso .....   | 444, 446     |
| Balfour-Standard, Valva centrale .....                     | 312, 314-315      | Bryant, Pinza per medicature .....                                       | 219          |
| Balfour, Divaricatore addominale .....                     | 312-313           | Buck, Curetta auricolare .....   | 676          |
| Balfour, Mod. USA, Divaricatore addominale .....           | 315               | Buck, Forbici per legature .....   | 108          |
| Balfour, Mod. USA, Valva di filo .....                     | 315               | Buck, Pinza per corpi estranei .....                                     | 672          |
| Balfour, Valva centrale .....                              | 313               | Bunnell, Sonda conduttrice per tendini .....                             | 508          |
| Ballenger-Hajek, Elevatore per il setto nasale .....       | 703               | Busch, Forbici ombelicale .....  | 90           |
| Ballenger, Bisturi per il setto nasale .....               | 700               | Byrd, Tubo di aspirazione .....  | 378          |
| Ballenger, Sgorbia per il setto nasale .....               | 705               |  |              |
| Barbara, Micro Ago auricolare .....                        | 660-661           | <b>C</b>   |              |
| Barbara, Micro Uncino auricolare .....                     | 660               | Calotta protettiva, Rubin .....  | 695          |
| Baron-Schuknecht, Tubo di aspirazione .....                | 369               | Candeletta dilatatrice, Guyon .....                                      | 594          |
| Barra trasversale, Martin-Rochard .....                    | 323               | Candeletta dilatatrice, Van Buren .....                                  | 594          |
| Barraquer-Troutman, Micro Portaghi .....                   | 406               | Cannula .....  | 381          |
| Barraquer, Micro Portaghi .....                            | 406-407, 419      | Cannula d' aspirazione .....   | 362-363-376  |
| Barraquer, Pinza depilatoria .....                         | 155               | Cannula d' aspirazione, Adson .....                                      | 364          |
| Base di Bakelit .....                                      | 669               | Cannula d' aspirazione, Fergusson .....                                  | 365-366      |
| Beacham, Amniotomo .....                                   | 619               | Cannula d' aspirazione, Frazier .....                                    | 364          |
| Beckman-Adson, Divaricatore automatico .....               | 299-300           | Cannula d' aspirazione, Landolt .....                                    | 370          |
| Beckmann, Coltello per vegetazioni adenoidee .....         | 720               | Cannula d' aspirazione, Poppen .....                                     | 367          |
|  |                   | Cannula d' aspirazione, Wullstein .....                                  | 368          |
|  |                   | Cannula d' aspirazione, Zoellner .....                                   | 368          |
|  |                   | Cannula di aspirazione .....   | 383          |
|  |                   | Cannula di aspirazione, Plester .....                                    | 383          |
|  |                   | Cannula per anestesia trasvaginale .....                                 | 381          |
|  |                   | Cannula per irrigazione vascolare, Schmid .....                          | 384          |
|  |                   | Cannula per la puntura del fegato, Menghini .....                        | 384          |
|  |                   | Cannula per lavaggio, Eicken-Killian .....                               | 720          |
|  |                   | Cannula per puntura lombale, Tuohy .....                                 | 382          |
|  |                   | Cannula per tonsille .....   | 382          |
|  |                   | Cannula per vene .....   | 381          |
|  |                   | Caplan, Pinza per il setto nasale .....                                  | 694          |
|  |                   | Carroll, Pinza per afferrare tendini .....                               | 509          |
|  |                   | Carrucola mobile, Martin-Rochard .....                                   | 323          |
|  |                   | Caspar, Pestone metallico .....  | 474          |
|  |                   | Castroviejo-Epker, Compasso .....  | 644          |
|  |                   | Castroviejo-Fino, Micro Portaghi .....                                   | 407          |
|  |                   | Castroviejo, Compasso .....  | 644          |
|  |                   | Castroviejo, Micro Portaghi .....  | 408, 418-419 |
|  |                   | Castroviejo, Pinza per afferrare e<br>rompere le lamette de rasoio ..... | 4            |
|  |                   | Cerullo, Valvola di aspirazione .....                                    | 370          |
|  |                   | Cesoia per ossa, Böhler .....  | 531          |
|  |                   | Cesoia per ossa, Cleveland .....   | 531          |
|  |                   | Cesoia per ossa, Cottle-Kazanjan .....                                   | 530          |
|  |                   | Cesoia per ossa, Liston .....  | 530          |
|  |                   | Cesoia per ossa, Liston-Key .....  | 534          |
|  |                   | Cesoia per ossa, Ruskin-Liston .....                                     | 532          |
|  |                   | Cesoia per ossa, Stille-Liston .....                                     | 532-533      |
|  |                   | Chaput, Pinza emostatica .....   | 168          |
|  |                   | Cheattle, Pinza per strumenti sterilizzazione .....                      | 750          |
|  |                   | Cheron, Pinza per medicature .....                                       | 221          |
|  |                   | Chiave .....   | 462          |
|  |                   | Chiave per approssimatore .....  | 160          |
|  |                   | Childe, Pinza per i margini della ferita .....                           | 439          |
|  |                   | Cinelli, Forbici nasale .....  | 50           |
|  |                   | Cinelli, Osteotomo .....   | 708          |
|  |                   | Citelli, Pinza osteotomo .....   | 674          |
|  |                   | Clamp ombelicale, Collin .....   | 642          |
|  |                   | Cleveland, Cesioia per ossa .....  | 531          |
|  |                   | Cleveland, Pinza-sgorbia .....   | 522          |
|  |                   | Clip vascolare, Biemer .....   | 158          |
|  |                   | Cloward, Divaricatore automatico .....                                   | 296-297      |
|  |                   | Cloward, Valva .....   | 296-297      |
|  |                   | Coakley, Curetta per antro .....   | 719          |
|  |                   | Cobb, Periostotomo .....   | 492          |
|  |                   | Cobb, Sgorbia .....  | 470          |
|  |                   | Cogswell, Tubo di aspirazione .....                                      | 378          |
|  |                   | Collier, Portaghi .....  | 409          |
|  |                   | Collin-Hartmann, Divaricatore .....                                      | 276          |
|  |                   | Collin, Baby, Divaricatore addominale .....                              | 304, 307-308 |
|  |                   | Collin, Clamp ombelicale .....   | 642          |
|  |                   | Collin, Divaricatore addominale .....                                    | 304-306      |
|  |                   | Collin, Manico per bisturi .....   | 6            |
|  |                   | Collin, Martello .....   | 476          |
|  |                   | Collin, Pinza per afferrare l'utero .....                                | 625          |
|  |                   | Collin, Pinza per afferrare organi .....                                 | 169          |
|  |                   | Collin, Pinza per afferrare tumori .....                                 | 169          |
|  |                   | Collin, Pinza per medicature .....                                       | 221          |
|  |                   | Collin, Specolo vaginale .....   | 600          |
|  |                   | Collin, Valva centrale .....   | 305-306      |
|  |                   | Coltelli, Virchow .....  | 3            |
|  |                   | Coltello circolare, Rosen .....  | 659          |
|  |                   | Coltello falcato come sinechia, Schuknecht .....                         | 659          |
|  |                   | Coltello falcato come sinechia, Wullstein .....                          | 659          |
|  |                   | Coltello per amputazione, Liston .....                                   | 13           |
|  |                   | Coltello per gesso, Esmarch .....  | 447          |
|  |                   | Coltello per gesso, Hopkins .....  | 447          |
|  |                   | Coltello per gesso, Martin .....   | 447          |
|  |                   | Coltello per lobi, Plester .....   | 659          |
|  |                   | Coltello per resezione .....   | 13           |
|  |                   | Coltello per vegetazioni adenoidee, Beckmann .....                       | 720          |
|  |                   | Compasso, Castroviejo .....  | 644          |
|  |                   | Compasso, Castroviejo-Epker .....  | 644          |
|  |                   | Contentore per strumenti .....   | 753          |
|  |                   | Converse, Bisturi per plastica nasale .....                              | 699          |
|  |                   | Converse, Divaricatore nasale .....                                      | 716          |
|  |                   | Converse, Forbici nasale .....   | 88           |
|  |                   | Converse, Uncino per le pinne nasali .....                               | 716          |
|  |                   | Cooley, Divaricatore per atrio .....                                     | 271          |
|  |                   | Cooley, Tubo di aspirazione .....  | 375          |
|  |                   | Cooper, Ago per legatura .....   | 432          |
|  |                   | coppia di tubi flessibili singoli, Strauss .....                         | 598          |
|  |                   | Cordes, Pinza intercambiabile per<br>bronco-esofagoscopia .....          | 733          |
|  |                   | Coryllos, Divaricatore .....   | 260          |
|  |                   | Cottle-Kazanjan, Cesioia per ossa .....                                  | 530          |
|  |                   | Cottle-Neivert, Uncino per<br>le pinne nasali .....                      | 717          |

|   |               |   |                   |   |                    |
|---|---------------|---|-------------------|---|--------------------|
| Cottle-Walsham, Pinza per raddizzare il setto nasale..... | 718           | DeBaKey, Forbici per dissezione.....                | 49                | Divaricatore pelvico, St. Marks.....                    | 274                |
| Cottle, Bisturi per plastica nasale.....                  | 699           | DeBaKey, Forbici vascolare.....                     | 72                | Divaricatore per aorta, Borowski.....                   | 266                |
| Cottle, Divaricatore nasale.....                          | 717           | DeBaKey, Pinza atraumatica.....                     | 135-136           | Divaricatore per aorta, Ross.....                       | 265                |
| Cottle, Elevatore in forma di sella.....                  | 717           | DeBaKey, Portaghi.....                              | 422               | Divaricatore per atrio, Cooley.....                     | 271                |
| Cottle, Elevatore per il periosto.....                    | 704           | Depressore uterino, Braun.....                      | 618               | Divaricatore per il ginocchio, Blount.....              | 507                |
| Cottle, Elevatore per il setto nasale.....                | 703-704       | Derf, Portaghi.....                                 | 409, 419          | Divaricatore per il timo, Lukens.....                   | 549                |
| Cottle, Forbici nasale.....                               | 85            | Dermatomo a mano, Silver.....                       | 14                | Divaricatore per laminectomia, Scoville.....            | 320                |
| Cottle, Martello.....                                     | 476           | Dermatomo, Humby.....                               | 14                | Divaricatore per laminectomia, Scoville-Haverfield..... | 320                |
| Cottle, Osteotomo.....                                    | 706           | Dermatomo, Schink.....                              | 14                | Divaricatore per ossa, Rasse.....                       | 226                |
| Cottle, Periostotomo.....                                 | 490           | Deschamps, Ago per legatura.....                    | 433-434           | Divaricatore per pelle.....                             | 226                |
| Cottle, Pinza per afferrare la pelle.....                 | 719           | Desjardins, Pinza per calcoli biliari.....          | 587               | Divaricatore per pelle, Guthrie.....                    | 227                |
| Cottle, Pinza per columella.....                          | 719           | Desjardins, Pinza per vie biliari.....              | 201               | Divaricatore per pelle, O'Connor.....                   | 227                |
| Cottle, Raspa nasale.....                                 | 711           | Desmarres, Divaricatore a forma di sella.....       | 229               | Divaricatore per pelle, Davidson.....                   | 261                |
| Cottle, Specolo nasale.....                               | 682-683       | Diapason.....                                       | 669               | Divaricatore per tiroide e vagina, Joll.....            | 303                |
| Cottle, Torchio per cartilagine.....                      | 710           | Diapason, French.....                               | 666               | Divaricatore per veni, Brom.....                        | 234                |
| Cottle, Uncino nasale.....                                | 715           | Diapason, Hartmann.....                             | 666-668           | Divaricatore per vescicole, Young.....                  | 589                |
| Cottle, Uncino per le pinne nasali.....                   | 717           | Diapason, König.....                                | 669               | Divaricatore spinale, Taylor.....                       | 507                |
| Coupland, Manico per aspirazione.....                     | 378           | Diapason, Lucae.....                                | 668               | Divaricatore vascolare.....                             | 228                |
| Coupland, Punta per aspirazione.....                      | 378           | Diapason, Martin.....                               | 667               | Divaricatore vescicale, Judd-Masson.....                | 592                |
| Crafoord, Pinza per preparazione e legature.....          | 188           | Diapason, Neuro.....                                | 669               | Divaricatore vescicale, Millin.....                     | 593                |
| Crile-Murray, Portaghi.....                               | 410           | Diapason, Rydel-Seiffert.....                       | 669               | Divaricatore, Brunner.....                              | 262-263            |
| Crile-Rankin, Pinza emostatica.....                       | 176           | Diapason, Uterino.....                              | 614-616           | Divaricatore, Collin-Hartmann.....                      | 276                |
| Crile-Wood, Portaghi.....                                 | 410, 415, 420 | Dieffenbach, Pinza Bulldog.....                     | 162               | Divaricatore, Coryllos.....                             | 260                |
| Crile, Pinza emostatica.....                              | 175           | Diethrich-Salyer, Forbici per dissezione.....       | 72                | Divaricatore, Cushing.....                              | 231                |
| Crile, Portaghi.....                                      | 414           | Diethrich, Forbici vascolare.....                   | 72                | Divaricatore, Deaver.....                               | 268-270            |
| Crivello per specola vaginale, Weissbarth.....            | 612           | Diethrich, Pinza Bulldog.....                       | 164               | Divaricatore, Doyen.....                                | 258                |
| Cucchiaino/uncino auricolare, Gross.....                  | 677           | Diethrich-Hegemann, Forbici vascolare.....          | 74                | Divaricatore, Doyen-Stille.....                         | 254                |
| Cucchiaino per placenta e ovaie, Cuzzi.....               | 641           | Diethrich-Potts, Forbici per arteria coronaria..... | 73                | Divaricatore, Farabeuf.....                             | 277                |
| Cucchiaino per placenta e ovaie, Pestalozza.....          | 642           | Diethrich-Potts, Forbici vascolare.....             | 73                | Divaricatore, Fritsch.....                              | 257                |
| Curetta auricolare, Buck.....                             | 676           | Dilatatore per condotti biliari, Bakes.....         | 585               | Divaricatore, Goelet.....                               | 279                |
| Curetta auricolare, Jansen.....                           | 677           | Dilatatore per il seno frontale, Ritter-Halle.....  | 720               | Divaricatore, Harrington.....                           | 267                |
| Curetta auricolare, Lempert.....                          | 679           | Dilatatore per tracheotomia, Laborde.....           | 548               | Divaricatore, Hösel.....                                | 255                |
| Curetta auricolare, Shapleigh.....                        | 676           | Dilatatore per tracheotomia, Trousseau.....         | 548               | Divaricatore, Israel.....                               | 242                |
| Curetta doppia.....                                       | 486           | Dilatatore rettale, Alan-Parks.....                 | 580               | Divaricatore, Kelly.....                                | 253, 273           |
| Curetta doppia, Faulkner.....                             | 719           | Dilatatore uterino, Hank.....                       | 617               | Divaricatore, Klapp.....                                | 235                |
| Curetta doppia, Jacobson.....                             | 486           | Dilatatore uterino, Hegar.....                      | 614-616           | Divaricatore, Kocher.....                               | 239, 247, 251, 258 |
| Curetta doppia, Molt.....                                 | 487           | Dingmann, Pinza per cartilagine.....                | 511               | Divaricatore, Kocher-Langenbeck.....                    | 248-249            |
| Curetta doppia, Volkmann.....                             | 486           | Disettore / Retrattore per tonsille, Hurd.....      | 727               | Divaricatore, Körte.....                                | 241                |
| Curetta doppia, Williger.....                             | 487           | Disettore doppio.....                               | 501               | Divaricatore, Lahey.....                                | 246                |
| Curetta per antro, Coakley.....                           | 719           | Disettore doppio, Alderdyce.....                    | 501               | Divaricatore, Langenbeck.....                           | 243-245            |
| Curetta per aspirazione.....                              | 636           | Disettore doppio, McDonald.....                     | 501               | Divaricatore, Langenbeck-Green.....                     | 245                |
| Curetta per aspirazione, Novak.....                       | 627           | Disettore per l'attico, Austin.....                 | 662               | Divaricatore, Langenbeck-Mini.....                      | 229                |
| Curetta per biopsia, Kevorkian.....                       | 627           | Disettore per palato, Salyer.....                   | 726               | Divaricatore, Little.....                               | 246                |
| Curetta per biopsia, Mod. München.....                    | 627           | Distributore per spazzole, Martin.....              | 742-743           | Divaricatore, Martin.....                               | 259                |
| Curetta tagliente.....                                    | 485           | Dittel, Strumenti per inserimento catetere.....     | 388               | Divaricatore, Martin-Rochard.....                       | 323                |
| Curetta tagliente, Bruns.....                             | 483-484       | Divaricatore.....                                   | 227-228, 230, 235 | Divaricatore, Mathieu.....                              | 279                |
| Curetta tagliente, Daubenspeck.....                       | 482           | Divaricatore.....                                   | 238               | Divaricatore, Meyerding.....                            | 230                |
| Curetta tagliente, Halle.....                             | 485           | Divaricatore a forma di sella, Cushing.....         | 232               | Divaricatore, Middeldorff.....                          | 252, 256           |
| Curetta tagliente, Modell USA.....                        | 485           | Divaricatore a forma di sella, Desmarres.....       | 229               | Divaricatore, Mikulicz.....                             | 273                |
| Curetta tagliente, Schede.....                            | 482           | Divaricatore a forma di sella, Gil-Vernet.....      | 233               | Divaricatore, Mikulicz.....                             | 272                |
| Curetta tagliente, Scoville.....                          | 484           | Divaricatore addominale, Balfour.....               | 312-313           | Divaricatore, Ollier.....                               | 240                |
| Curetta tagliente, Simon.....                             | 484           | Divaricatore addominale, Balfour-Baby.....          | 311               | Divaricatore, Parker.....                               | 278                |
| Curetta tagliente, Spratt.....                            | 483           | Divaricatore addominale, Balfour-Standard.....      | 314               | Divaricatore, Parker-Langenbeck.....                    | 279                |
| Curetta tagliente, Volkmann.....                          | 481-482       | Divaricatore addominale, Balfour, Mod. USA.....     | 315               | Divaricatore, Parker-Mott.....                          | 278                |
| Curetta uterina, Blake.....                               | 633           | Divaricatore addominale, Collin.....                | 304-306           | Divaricatore, Ragnell-Davis.....                        | 231                |
| Curetta uterina, Greene.....                              | 636           | Divaricatore addominale, Collin, Baby.....          | 304, 307, 308     | Divaricatore, Richardson.....                           | 253                |
| Curetta uterina, Recamier.....                            | 634           | Divaricatore addominale, Gosset.....                | 310-311           | Divaricatore, Richardson-Eastman.....                   | 252                |
| Curetta uterina, Schrüder.....                            | 633           | Divaricatore addominale, Gosset-Baby.....           | 310               | Divaricatore, Roux.....                                 | 276                |
| Curetta uterina, Simon.....                               | 633           | Divaricatore addominale, Kirschner.....             | 317-318           | Divaricatore, Roux-Baby.....                            | 277                |
| Curetta uterina, Sims.....                                | 634           | Divaricatore addominale, O'Sullivan-O'Connor.....   | 316               | Divaricatore, Roux-Mini.....                            | 277                |
| Cusco, Specolo vaginale.....                              | 600           | Divaricatore addominale, Ricard.....                | 307               | Divaricatore, Sauerbruch.....                           | 264                |
| Cushing-Taylor, Pinza per dissezione.....                 | 133           | Divaricatore autostatico.....                       | 280, 286-287, 302 | Divaricatore, Senn-Green.....                           | 231                |
| Cushing, Divaricatore.....                                | 231           | Divaricatore autostatico, Adson.....                | 285, 294-295, 298 | Divaricatore, Senn-Miller.....                          | 231                |
| Cushing, Divaricatore a forma di sella.....               | 232           | Divaricatore autostatico, Alm.....                  | 281               | Divaricatore, Simon.....                                | 259                |
| Cushing, Pinza per dissezione.....                        | 130, 133, 142 | Divaricatore autostatico, Anderson-Adson.....       | 282               | Divaricatore, solo, Ricard.....                         | 307                |
| Cuzzi, Cucchiaino per placenta e ovaie.....               | 641           | Divaricatore autostatico, Beckman-Adson.....        | 299-300           | Divaricatore, Strandell-Stille.....                     | 234                |
| Czerny, Pinza per il collo dell'utero.....                | 622           | Divaricatore autostatico, Beckmann.....             | 298               | Divaricatore, Volkmann.....                             | 236-238            |
| Czerny, Specolo rettale.....                              | 579           | Divaricatore autostatico, Cloward.....              | 296-297           | Divaricatore, Wassmund.....                             | 241                |
| <b>D</b>  |               | Divaricatore autostatico, Cloward.....              | 296-297           | Divaricatore, Zenker.....                               | 250                |
| Dado premistoppa.....                                     | 763           | Divaricatore autostatico, Finsen.....               | 280               | Divaricatore, Zenker.....                               | 250                |
| Dandy-Mosquito, Pinza emostatica.....                     | 176           | Divaricatore autostatico, Finsen-Martin.....        | 280               | Divaricatore, Zenker.....                               | 250                |
| Dandy, Pinza emostatica.....                              | 176           | Divaricatore autostatico, Gelpi.....                | 303               | Divaricatore, Zenker.....                               | 250                |
| Dartigues, Pinza per afferrare l'utero.....               | 625           | Divaricatore autostatico, Henley.....               | 293               | Divaricatore, Zenker.....                               | 250                |
| Daubenspeck, Curetta tagliente.....                       | 482           | Divaricatore autostatico, Jansen.....               | 281               | Divaricatore, Zenker.....                               | 250                |
| Davidson, Divaricatore per scapola.....                   | 261           | Divaricatore autostatico, Low-Profile.....          | 302               | Divaricatore, Zenker.....                               | 250                |
| Day, Uncino auricolare.....                               | 678           | Divaricatore autostatico, Martin.....               | 301               | Divaricatore, Zenker.....                               | 250                |
| De Martel-Wolfson, Pinza per anastomosi intestinali.....  | 566           | Divaricatore autostatico, Milligan.....             | 292               | Divaricatore, Zenker.....                               | 250                |
| De Martel-Wolfson, Portapinze.....                        | 567           | Divaricatore autostatico, Mollison.....             | 289               | Divaricatore, Zenker.....                               | 250                |
| De Martel-Wolfson, Serrapinze.....                        | 566           | Divaricatore autostatico, Norfolk-Norwich.....      | 283               | Divaricatore, Zenker.....                               | 250                |
| Dean, Forbici per tonsille.....                           | 80, 82        | Divaricatore autostatico, Plester.....              | 290               | Divaricatore, Zenker.....                               | 250                |
| Deaver, Divaricatore.....                                 | 268-270       | Divaricatore autostatico, Scalp-Contour.....        | 282               | Divaricatore, Zenker.....                               | 250                |
| Deaver, Forbici per chirurgia.....                        | 23            | Divaricatore autostatico, Travers.....              | 283               | Divaricatore, Zenker.....                               | 250                |
| Deaver, marTract.....                                     | 337           | Divaricatore autostatico, Weitlaner.....            | 284, 287-288      | Divaricatore, Zenker.....                               | 250                |
| DeBaKey-Adson, Tubo di aspirazione.....                   | 371           | Divaricatore autostatico, Weitlaner-Baby.....       | 292               | Divaricatore, Zenker.....                               | 250                |
| DeBaKey-Diethrich, Pinza Bulldog.....                     | 164           | Divaricatore autostatico, Weitlaner-Wullstein.....  | 289               | Divaricatore, Zenker.....                               | 250                |
| DeBaKey, Forbici angolate.....                            | 122           | Divaricatore autostatico, Williams.....             | 291               | Divaricatore, Zenker.....                               | 250                |
|   |               | Divaricatore del collo vescicale, Millin.....       | 592               | Divaricatore, Zenker.....                               | 250                |
|   |               | Divaricatore nasale, Aufrecht.....                  | 715, 717          | Divaricatore, Zenker.....                               | 250                |
|   |               | Divaricatore nasale, Converse.....                  | 716               | Divaricatore, Zenker.....                               | 250                |
|   |               | Divaricatore nasale, Cottle.....                    | 717               | Divaricatore, Zenker.....                               | 250                |
|   |               |   |                   | Divaricatore, Zenker.....                               | 250                |

|   |                 |   |                |
|---|-----------------|---|----------------|
| <b>E</b>  |                 |   |                |
| Echlin, Pinza-sgorbia .....   | 527             | Forbici per bendaggi, Lorenz .....                                | 442            |
| Eicken-Killian, Cannula per lavaggio .....                          | 720             | Forbici per bendaggi, Universal .....                             | 444            |
| Eiselsberg, Forbici per legature .....                              | 108             | Forbici per chirurgia .....                                       | 16-23, 92      |
| Elevatore Curvo Subustra .....                                      | 726             | Forbici per chirurgia, Deaver .....                               | 23             |
| Elevatore in forma di sella, Cottle .....                           | 717             | Forbici per chirurgia, Goldman-Fox .....                          | 91             |
| Elevatore per il periosto, Cottle .....                             | 704             | Forbici per chirurgia, Joseph .....                               | 60-61          |
| Elevatore per il periosto, Joseph .....                             | 704             | Forbici per chirurgia, Kelly .....                                | 32-33          |
| Elevatore per il periosto, Joseph-Masing .....                      | 704             | Forbici per chirurgia, Knapp .....                                | 22             |
| Elevatore per il periosto, Masing .....                             | 704             | Forbici per chirurgia, Mayo .....                                 | 24-25          |
| Elevatore per il periosto, Roger .....                              | 704             | Forbici per chirurgia, Sanvenero .....                            | 59             |
| Elevatore per il setto nasale, Ballenger-Hajek .....                | 703             | Forbici per chirurgia, Wagner .....                               | 92             |
| Elevatore per il setto nasale, Cottle .....                         | 703-704         | Forbici per dissezione .....                                      | 44, 59, 64     |
| Elevatore per il setto nasale, Freer .....                          | 701-702         | Forbici per dissezione, DeBaKey .....                             | 49             |
| Elevatore per il setto nasale, Halle .....                          | 701             | Forbici per dissezione, Diethrich-Salyer .....                    | 72             |
| Elevatore per il setto nasale, Howard .....                         | 703             | Forbici per dissezione, Hohenfellner .....                        | 49             |
| Elevatore per il setto nasale, Joseph .....                         | 701             | Forbici per dissezione, Jameson .....                             | 69             |
| Elevatore per il setto nasale, Killian .....                        | 703             | Forbici per dissezione, Kilner .....                              | 65             |
| Elevatore per il setto nasale, McKenty .....                        | 701-702         | Forbici per dissezione, Knapp .....                               | 114            |
| Elevatore per il setto nasale, Pennington .....                     | 704             | Forbici per dissezione, Kübler .....                              | 44             |
| Elevatore per ossa .....  | 502             | Forbici per dissezione, Lexer .....                               | 46-48, 51, 115 |
| Elevatore per ossa, Bennett .....                                   | 506             | Forbici per dissezione, Lexer-Baby .....                          | 51             |
| Elevatore per ossa, Hohmann .....                                   | 503-505         | Forbici per dissezione, Mayo-Harrington .....                     | 29             |
| Elevatore per ossa, Hohmann, mini .....                             | 502             | Forbici per dissezione, Mayo-Lexer .....                          | 116            |
| Elevatore per ossa, Lange-Hohmann .....                             | 505             | Forbici per dissezione, Mayo-Noble .....                          | 29             |
| Elevatore per palato, Salyer .....                                  | 726             | Forbici per dissezione, Mayo-Stille .....                         | 26-28          |
| Elevatore per tonsille, Henke .....                                 | 728             | Forbici per dissezione, Metzenbaum .....                          | 37-44          |
| Elevatore, Adson .....  | 498             | Forbici per dissezione, Metzenbaum-Nelson .....                   | 40             |
| Elevatore, Langenbeck .....   | 500             | Forbici per dissezione, Metzenbaum-Thorek .....                   | 115            |
| Elevatore, Martin-Langenbeck .....                                  | 500             | Forbici per dissezione, Olivecrona .....                          | 79             |
| Elevatore, Quervain .....   | 501             | Forbici per dissezione, Ragnell .....                             | 123            |
| Elevatore, Sebileau .....   | 501             | Forbici per dissezione, Reynolds .....                            | 67-68          |
| Elevatore, Williger .....   | 501             | Forbici per dissezione, Salyer .....                              | 59, 107        |
| Emmett, Uncino per fistole .....                                    | 626             | Forbici per dissezione, Shea Vein Graft .....                     | 64             |
| Endospecolo, Kogan .....  | 613             | Forbici per dissezione, Thorek .....                              | 50             |
| Esmarch, Coltello per gesso .....                                   | 447             | Forbici per enterotomia .....                                     | 106            |
| Esmarch, Forbici per gesso .....                                    | 443             | Forbici per enucleazione .....                                    | 103            |
| Eves, Serranodi per tonsille .....                                  | 730             | Forbici per episiotomia, Braun-Stadler .....                      | 89             |
|   |                 | Forbici per episiotomia, Waldmann .....                           | 89             |
| <b>F</b>  |                 | Forbici per Face-lift .....                                       | 66             |
| Farabeuf-Collin, Periostotomo .....                                 | 491             | Forbici per Face-lift, Aston .....                                | 45             |
| Farabeuf, Divaricatore .....  | 277             | Forbici per Face-lift, Gorney .....                               | 45, 119        |
| Farabeuf, Periostotomo .....  | 491             | Forbici per Face-lift, Gorney-Freeman .....                       | 118            |
| Farabeuf, Tenaglia per ossa .....                                   | 516             | Forbici per Face-lift, Kaye .....                                 | 44             |
| Farrrell, Portacottone .....  | 355             | Forbici per Face-lift, Peck-Joseph .....                          | 62-63          |
| Farrior, Specolo auricolare .....                                   | 665             | Forbici per Face-lift, Rees .....                                 | 119            |
| Faulkner, Curetta doppia .....                                      | 719             | Forbici per Face-lift, Salyer .....                               | 107            |
| Faure, Pinza per biopsia .....                                      | 628             | Forbici per gengiva .....   | 93-94          |
| Faure, Pinza per peritoneo .....                                    | 210             | Forbici per gengiva, Goldman-Fox .....                            | 91             |
| Favaloro, Forbici vascolare .....                                   | 77              | Forbici per gengiva, La Grange .....                              | 93             |
| Fehland, Pinza per anastomosi rettali .....                         | 577             | Forbici per gengiva, Locklin .....                                | 94             |
| Feilchenfeld, Pinza per scheggie .....                              | 154             | Forbici per gesso, Bergmann .....                                 | 443            |
| Fergusson, Cannula d' aspirazione .....                             | 365-366         | Forbici per gesso, Bruns .....                                    | 444, 446       |
| Fergusson, Tenaglia per ossa .....                                  | 513             | Forbici per gesso, Esmarch .....                                  | 443            |
| Ferris-Smith-Kerrison, Pinza tagliente<br>per seno sfenoidale ..... | 697             | Forbici per gesso, Stille-Martin .....                            | 445            |
| Filo in acciaio .....   | 670, 684, 730   | Forbici per ginecologia .....                                     | 120-121        |
| Finocchio, Pinza per preparazione<br>e legature .....               | 198             | Forbici per ginecologia, Doyen .....                              | 34             |
| Finocchio, Portaghi .....   | 412, 423        | Forbici per ginecologia, Sims .....                               | 30-31          |
| Finsen-Martin, Divaricatore autostatico .....                       | 280             | Forbici per ginecologia, Sims-Siebold .....                       | 35             |
| Finsen, Divaricatore autostatico .....                              | 280             | Forbici per ginecologia, Wertheim .....                           | 36             |
| Fisch, Micro Dissettore .....                                       | 662             | Forbici per incisione .....                                       | 23             |
| Fisher, Bisturi per tonsille .....                                  | 727             | Forbici per iridectomia .....                                     | 95-99          |
| Flebo-dissettore, Varady .....                                      | 352             | Forbici per iridectomia, Jabaley .....                            | 100            |
| Flebo-estrattore, Varady .....                                      | 352             | Forbici per iridectomia, Mod. Bonn .....                          | 96             |
| Fomon, Bisturi per plastica nasale .....                            | 699             | Forbici per iridectomia, Stevens .....                            | 101-102        |
| Fomon, Forbici nasale .....   | 50, 83-84       | Forbici per legature .....  | 111-112        |
| Fomon, Raspa nasale .....   | 712, 714        | Forbici per legature, Buck .....                                  | 108            |
| Fomon, Scalpello .....  | 707             | Forbici per legature, Eiselsberg .....                            | 108            |
| Fomon, Uncino per le pinne nasali .....                             | 715-716         | Forbici per legature, Littauer .....                              | 108            |
| Forbici angolate, De BaKey .....                                    | 122             | Forbici per legature, Northbent .....                             | 107            |
| Forbici fine per dissezione, Lexer-Fino .....                       | 52              | Forbici per legature, O'Brian .....                               | 107            |
| Forbici fine per dissezione,<br>Metzenbaum-Fino .....               | 53-58, 113, 117 | Forbici per legature, Spencer .....                               | 108            |
| Forbici fine per dissezione, Metzenbaum-Lahey .....                 | 117             | Forbici per neurchirurgia, Strully .....                          | 77             |
| Forbici fine per dissezione, Siegert .....                          | 117             | Forbici per strabismo .....                                       | 103            |
| Forbici fine per dissezione, Toennis-Adson .....                    | 78, 113         | Forbici per strabismo, Westcott .....                             | 103            |
| Forbici nasale, Cinelli .....                                       | 50              | Forbici per tagliare fili metallico, Beebee .....                 | 110            |
| Forbici nasale, Converse .....                                      | 88              | Forbici per tagliare fili metallico, Martin .....                 | 124            |
| Forbici nasale, Cottle .....  | 85              | Forbici per tagliare fili metallico, Universal .....              | 109            |
| Forbici nasale, Fomon .....   | 50, 83-84       | Forbici per tonsille, Dean .....                                  | 80, 82         |
| Forbici nasale, Heymann .....                                       | 86-87           | Forbici per tonsille, Good .....                                  | 81             |
| Forbici ombelicale, Busch .....                                     | 90              | Forbici per unghie .....  | 744            |
| Forbici ombelicale, Mod. USA .....                                  | 90              | Forbici vascolare .....   | 71, 77         |
| Forbici ombelicale, Schuhmacher .....                               | 90              | Forbici vascolare, De BaKey .....                                 | 72             |
| Forbici per arteria coronaria, Dietrich-Potts .....                 | 73              | Forbici vascolare, Diethrich .....                                | 72             |
| Forbici per bendaggi .....  | 442             | Forbici vascolare, Dietrich-Hegemann .....                        | 74             |
| Forbici per bendaggi, Lister .....                                  | 442, 446        | Forbici vascolare, Dietrich-Potts .....                           | 73             |
|   |                 | Forbici vascolare, Favaloro .....                                 | 77             |
|   |                 | Forbici vascolare, Potts-Smith .....                              | 74-75          |
|   |                 | Forbici vascolare, Satinsky .....                                 | 71             |
|   |                 | Forbici vascolare, Schmieden-Taylor .....                         | 77             |
|   |                 | Forchetta da sutura .....   | 438            |
|   |                 | Forcipe obstetrica, Kielland .....                                | 639            |
|   |                 | Forcipe obstetrica, Nägele .....                                  | 638            |
|   |                 | Forcipe obstetrica, Piper .....                                   | 639            |
|   |                 | Forcipe obstetrica, Simpson .....                                 | 638            |
|   |                 | Forcipe obstetrica, Wrigley .....                                 | 638            |
|   |                 | Foregger, Set per laringoscopia .....                             | 391-392        |
|   |                 | Foregger, Set per laringoscopia (luce fredda) .....               | 396            |
|   |                 | Foregger, Spatola per laringoscopia .....                         | 392-393        |
|   |                 | Foregger, Spatola per laringoscopia<br>(luce fredda) .....        | 397            |
|   |                 | Förster, Pinza per tamponi e sponge .....                         | 222-223        |
|   |                 | Foster-Gillies, Portaghi .....                                    | 428            |
|   |                 | Fraenkel, Pinza intercambiabile<br>per bronco-esofagoscopia ..... | 732            |
|   |                 | Frazier, Cannula d' aspirazione .....                             | 364            |
|   |                 | Freer, Bisturi per il setto nasale .....                          | 700            |
|   |                 | Freer, Bisturi per mucosa .....                                   | 700            |
|   |                 | Freer, Elevatore per il setto nasale .....                        | 701-702        |
|   |                 | Freer, Scalpello per il setto nasale .....                        | 705            |
|   |                 | Freer, Sgorbia per il setto nasale .....                          | 705            |
|   |                 | Freer, Uncino per mucosa .....                                    | 716            |
|   |                 | French, Diapason .....  | 666            |
|   |                 | Friedmann, Pinza-sgorbia .....                                    | 522            |
|   |                 | Fritsch, Divaricatore .....                                       | 257            |
|   |                 | Frosch, Tenaglia per ossa .....                                   | 513            |
|   |                 | Frykholm, Pinza-sgorbia .....                                     | 528            |
|   |                 | Fuller, Pinza per introduzione .....                              | 658            |
|   |                 | Funne di trazione, Nabatoff .....                                 | 353            |
|   |                 | <b>G</b>  |                |
|   |                 | Gellhorn, Pinza per biopsia .....                                 | 628            |
|   |                 | Gelpi, Divaricatore autostatico .....                             | 303            |
|   |                 | Gemini, Pinza per preparazione e legature .....                   | 192            |
|   |                 | Gerald, Pinza atraumatica .....                                   | 136            |
|   |                 | Gerald, Pinza per dissezione .....                                | 130            |
|   |                 | Gerald, Pinza per dissezione con denti .....                      | 131, 142       |
|   |                 | Gil-Vernet, Divaricatore a forma di sella .....                   | 233            |
|   |                 | Gillies-Mini, Portaghi .....                                      | 428            |
|   |                 | Gillies, Pinza per dissezione con denti .....                     | 131, 140       |
|   |                 | Gillies, Portaghi .....   | 414, 428       |
|   |                 | Goelet, Divaricatore .....  | 279            |
|   |                 | Goldman-Fox, Forbici per chirurgia .....                          | 91             |
|   |                 | Goldman-Fox, Forbici per gengiva .....                            | 91             |
|   |                 | Goldsmith (Thudichum), Specolo nasale .....                       | 680            |
|   |                 | Good, Forbici per tonsille .....                                  | 81             |
|   |                 | Gorney-Freeman, Forbici per Face-lift .....                       | 118            |
|   |                 | Gorney, Forbici per Face-lift .....                               | 45, 119        |
|   |                 | Gosset-Baby, Divaricatore addominale .....                        | 310            |
|   |                 | Gosset, Divaricatore addominale .....                             | 310-311        |
|   |                 | Gosset, Valva centrale .....                                      | 310            |
|   |                 | Graefe, Micro Divaricatore .....                                  | 226            |
|   |                 | Graig, Pinza per il setto nasale .....                            | 687            |
|   |                 | Grave, Specolo vaginale .....                                     | 601            |
|   |                 | Green-Armytage, Pinza emostatiche<br>per tagli cesarei .....      | 640            |
|   |                 | Greene, Curetta uterina .....                                     | 636            |
|   |                 | Gross-Maier, Pinza per medicature .....                           | 220            |
|   |                 | Gross, Cucchiaino/uncino auricolare .....                         | 677            |
|   |                 | Grünwald (Jansen), Pinza per medicature .....                     | 686            |
|   |                 | Grünwald, Pinza auricolare .....                                  | 671            |
|   |                 | Guedel-Negus, Set per laringoscopia .....                         | 390            |
|   |                 | Guedel-Negus, Spatola per laringoscopia .....                     | 390            |
|   |                 | Guilen, Mandrino .....  | 720            |
|   |                 | Guilen, Raspatore con aspiratore .....                            | 720            |
|   |                 | Gunnar-Hey, Pinza con rotelle .....                               | 215            |
|   |                 | Guthrie, Divaricatore per pelle .....                             | 227            |
|   |                 | Guttman, Specolo vaginale .....                                   | 601            |
|   |                 | Guyon, Candeletta dilatatrice .....                               | 594            |
|   |                 | Guyon, Pinza per peduncoli renali .....                           | 199-200        |
|   |                 | <b>H</b>  |                |
|   |                 | Haberer, Spatola addominale .....                                 | 348            |
|   |                 | Hajek, Pinza tagliente per seno sfenoidale .....                  | 696            |
|   |                 | Halle, Curetta tagliente .....                                    | 485            |
|   |                 | Halle, Elevatore per il setto nasale .....                        | 701            |
|   |                 | Halsey, Portaghi .....  | 409, 420       |
|   |                 | Halsted-Mosquito, Pinza emostatica .....                          | 171, 172       |
|   |                 | Hank, Dilatatore uterino .....                                    | 617            |
|   |                 | Harrington, Divaricatore .....                                    | 267            |
|   |                 | Harrington, marTract .....  | 339            |
|   |                 | Hartmann-Halle, Specolo nasale .....                              | 680            |
|   |                 | Hartmann-Herzfeld, Pinza per polipi auricolari .....              | 673            |
|   |                 | Hartmann-Hoffmann, Pinza per polipi auricolari .....              | 673            |
|   |                 | Hartmann-Wollstein, Pinza per polipi auricolari .....             | 673            |
|   |                 | Hartmann, Appoggiapiedi .....                                     | 668            |
|   |                 | Hartmann, Diapason .....  | 666-668        |
|   |                 | Hartmann, Pinza emostatica .....                                  | 171            |
|   |                 | Hartmann, Pinza per polipi auricolari .....                       | 672-673        |



|  |          |  |                    |  |                    |
|--|----------|--|--------------------|--|--------------------|
| Hartmann, Pinza per polipi nasali.....                   | 686      | K  |                    |  |                    |
| Hartmann, Pinza per tonsille.....                        | 731      | Kader, Spatola addominale.....                     | 275                | Lange, Uncino per le pinne nasali.....                 | 715                |
| Hartmann, Pinza tagliente per il naso.....               | 693      | Kahre-Williger, Periostotomo.....                  | 494                | Langenbeck-Green, Divaricatore.....                    | 245                |
| Hartmann, Pinza-sgorbia.....                             | 523      | Kallmorgen, Specolo vaginale.....                  | 607                | Langenbeck-Mini, Divaricatore.....                     | 229                |
| Hartmann, Sonda auricolare.....                          | 670      | Kallmorgen, Valva vaginale.....                    | 607                | Langenbeck, Divaricatore.....                          | 243-245            |
| Hartmann, Specolo auricolare.....                        | 664      | Kaye, Forbici per Face-lift.....                   | 44                 | Langenbeck, Elevatore.....                             | 500                |
| Hartmann, Specolo auricolare, set.....                   | 664      | Kaye, Manico per bisturi.....                      | 8                  | Langenbeck, marTract.....                              | 335-336, 339       |
| Hartmann, Uncino auricolare.....                         | 677      | Kelly, Pinza emostatica.....                       | 175                | Langenbeck, Periostotomo.....                          | 490                |
| Hayes, Pinza per anastomosi retтали.....                 | 576      | Kelly, Divaricatore.....                           | 253, 273           | Langenbeck, Portaghi.....                              | 430                |
| Heaney, Pinza per isterectomia.....                      | 204      | Kelly, Forbici per chirurgia.....                  | 32-33              | Langenbeck, Tenaglia per ossa.....                     | 513                |
| Heaney, Portaghi.....                                    | 411, 422 | Kelly, Pinza emostatica.....                       | 174                | Lawrence, Pinza per preparazione e legature.....       | 203                |
| Heavy Duty, Micro Portaghi.....                          | 416      | Kelly, Pinza per polipi uterini.....               | 623                | Leksell-Stille, Pinza-sgorbia.....                     | 528                |
| Hegar-Baumgartner, Portaghi.....                         | 410, 420 | Kelly, Pinza per preparazione e legature.....      | 202                | Lempert, Curetta auricolare.....                       | 679                |
| Hegar-Vascular, Portaghi.....                            | 425      | Kelly, Sfincteroscopia.....                        | 581                | Lempert, Pinza-sgorbia.....                            | 523                |
| Hegar, Dilatatore uterino.....                           | 614-616  | Kern, Pinza per ossa.....                          | 515                | Lempert, Raspatorio auricolare.....                    | 679                |
| Hegar, Portaghi.....                                     | 425      | Kerrison, Pinza tagliente per seno mascellare..... | 698                | Lerliche, Pinza emostatica.....                        | 173                |
| Hegenbarth, Pinza per applicare le graffe.....           | 439      | Kevorkian, Curetta per biopsia.....                | 627                | Leva osterica, Sellheim.....                           | 640                |
| Heiming, Pinza per calcoli renali.....                   | 584      | Kevorkian, Pinza per biopsia.....                  | 631                | Leva per corpi estranei, Zaufal.....                   | 677                |
| Heiss, Pinza per preparazione e legature.....            | 186      | Key, Periostotomo.....                             | 491                | Lewin, Tenaglia per ossa.....                          | 512                |
| Henke, Elevatore per tonsille.....                       | 728      | Kielland, Forcipe obstetrica.....                  | 639                | Lewis, Raspa nasale.....                               | 712                |
| Hibbs, Divaricatore autostatico.....                     | 293      | Killian-Claus, Sgorbia per il setto nasale.....    | 705                | Lexer-Baby, Forbici per dissezione.....                | 51                 |
| Henley, Valva centrale.....                              | 293      | Killian, Elevatore per il setto nasale.....        | 703                | Lexer-Fino, Forbici fine per dissezione.....           | 52                 |
| Hennig, Pinza per gesso.....                             | 448      | Killian, Sgorbia per il setto nasale.....          | 705                | Lexer-Mini, Sgorbia.....                               | 464                |
| Hepp-Scheidel, Micro Portaghi.....                       | 415      | Killian, Specolo nasale.....                       | 681                | Lexer, Forbici per dissezione.....                     | 46-48, 51, 115     |
| Hepp-Scheidel, Pinza per afferrare tubi.....             | 147      | Kilner, Forbici per dissezione.....                | 65                 | Lexer, Osteotomo.....                                  | 465                |
| Heymann, Forbici nasale.....                             | 86-87    | Kilner, Portaghi.....                              | 419                | Lexer, Scalpelli per spongiosa.....                    | 463                |
| Heywood-Smith, Pinza per polipi uterini.....             | 623      | Kilner, Uncino per le pinne nasali.....            | 716                | Lexer, Sgorbia.....                                    | 465                |
| Hibbs, Osteotomo.....                                    | 471-472  | Kirschner, Divaricatore addominale.....            | 317-318            | Lima per alveolotomia, Miller.....                     | 499                |
| Hibbs, Scalpello.....                                    | 471      | Kirschner, marTract.....                           | 334                | Lima per ossa.....                                     | 497                |
| Hibbs, Sgorbia.....                                      | 472      | Kirschner, Telaio, solo.....                       | 317-319            | Lima per ossa, Joseph.....                             | 711                |
| Hohenfellner, Forbici per dissezione.....                | 49       | Kirschner, Valva.....                              | 317-319            | Lima per ossa, Miller-Colburn.....                     | 498-499            |
| Hohmann, Elevatore per ossa.....                         | 503-505  | Klapp, Divaricatore.....                           | 235                | Lima per unghie.....                                   | 745                |
| Hohmann, mini, Elevatore per ossa.....                   | 502      | Kleinert-Kutz, Pinza per afferrare tendini.....    | 510                | Lister, Forbici per bendaggi.....                      | 442, 446           |
| Hoke, Osteotomo.....                                     | 471      | Knapp, Forbici per chirurgia.....                  | 22                 | Lister, Pinza per seni.....                            | 219                |
| Hopkins, Coltello per gesso.....                         | 447      | Knapp, Forbici per dissezione.....                 | 114                | Liston-Key, Cesoia per ossa.....                       | 534                |
| Hösel, Divaricatore.....                                 | 255      | Knight, Pinza per il setto nasale.....             | 687                | Liston, Cesoia per ossa.....                           | 530                |
| House-Dieter, Pinza per testa del martelletto.....       | 657      | Kocher (Ochsner), Pinza emostatica.....            | 183-184            | Liston, Coltello per amputazione.....                  | 13                 |
| House, Adattatore di aspirazione.....                    | 374      | Kocher-Langenbeck, Divaricatore.....               | 248-249            | Littauer, Forbici per legature.....                    | 108                |
| House, Micro cucchiaio.....                              | 663      | Kocher-Nippol, Pinza emostatica.....               | 179                | Littauer, Pinza depilatoria.....                       | 155                |
| House, Micro Sonda per misurare.....                     | 663      | Kocher, Divaricatore.....                          | 239, 247, 251, 258 | Little, Divaricatore.....                              | 246                |
| House, Tubo di aspirazione.....                          | 374      | Kocher, Pinza emostatica.....                      | 179                | Locklin, Forbici per gengiva.....                      | 94                 |
| Howard, Elevatore per il setto nasale.....               | 703      | Kocher, Pinza intestinale.....                     | 563-564, 573-574   | Lockwood, Pinza per afferrare intestino e tessuti..... | 557                |
| Huber, Manico universale.....                            | 632      | Kocher, Sonda per gozzo.....                       | 550                | Lorenz, Forbici per bendaggi.....                      | 442                |
| Humby, Dermatomo.....                                    | 14       | Kogan, Endoscopio.....                             | 613                | Lorna, Pinza fissateli.....                            | 212                |
| Humby, Lama di ricambio.....                             | 14       | König, Diapason.....                               | 669                | Lovelace, Pinza emostatica.....                        | 176                |
| Hunter, Pinza per scheggie.....                          | 154      | König, Periostotomo.....                           | 490                | Low-Profile, Divaricatore autostatico.....             | 302                |
| Hurd, Disettore / Retrattore per tonsille.....           | 727      | König, Sonda conduttrice.....                      | 437                | Low-Profile, Piroma.....                               | 302                |
| <b>I</b>   |          | Körte, Divaricatore.....                           | 241                | Low-Profile, Valva centrale.....                       | 302                |
| Iowa, Pinza per il collo dell'utero.....                 | 621      | Krause-Voss, Serranodi.....                        | 670, 684           | Lower, Pinza per preparazione e legature.....          | 198                |
| Israel, Divaricatore.....                                | 242      | Krause, Pinza intercambiabile.....                 |                    | Lubet-Barbon, Pinza per tamponamenti nasali.....       | 686                |
| Isterometro, Sims.....                                   | 618      | per bronco-esofagoscopia.....                      | 733                | Lucae, Ago per timpano.....                            | 678                |
| Isterometro, Valleix.....                                | 618      | Krause, Serranodi.....                             | 670, 684           | Lucae, Bottone di ricambio.....                        | 668                |
| Irterson, Uncino tracheale.....                          | 549      | Krenkel, Raspatore per palato.....                 | 701                | Lucae, Diapason.....                                   | 668                |
| Ives-Fansler, Anuscopio.....                             | 579      | Kressner, Pinza per il setto nasale.....           | 718                | Lucae, Martello.....                                   | 476                |
| <b>J</b>   |          | Kristeller, Specolo vaginale.....                  | 603-606            | Lucae, Uncino auricolare.....                          | 677                |
| Jabaley, Forbici per iridectomia.....                    | 100      | Kristeller, Valva vaginale.....                    | 603-606            | Lucae, Zoccolo.....                                    | 668                |
| Jaboma, Micro Portaghi.....                              | 415      | Kronecker, Ago per legatura.....                   | 432                | Luer-Körte, Pinze per calcoli biliari.....             | 588                |
| Jaboma, Micro-Forbici.....                               | 105      | Kübler, Forbici per dissezione.....                | 44                 | Luer, Pinza-sgorbia.....                               | 525                |
| Jaboma, Pinza per dissezione.....                        | 135      | Kübler, Pinza per dissezione.....                  | 134                | Luer, Tubo di aspirazione.....                         | 369                |
| Jaboma, Pinza per dissezione con denti.....              | 135      | Kübler, Portaghi.....                              | 430                | Luer, Uncino tracheale.....                            | 549                |
| Jackson, Specolo vaginale.....                           | 602      | Kümmel, Spatola addominale.....                    | 275                | Lukens, Divaricatore per il timo.....                  | 549                |
| Jackson, Uncino tracheale.....                           | 549      | <b>L</b>   |                    | Luniatschek, Tamponatori.....                          | 728                |
| Jacobs, Pinza per il collo dell'utero.....               | 621      | La Grange, Forbici per gengiva.....                | 93                 | M. G. Hospital, Portaghi.....                          | 411                |
| Jacobson, Curetta doppia.....                            | 486      | Laborde, Dilatatore per tracheotomia.....          | 548                | Madrevite ad alette, Alan-Parks.....                   | 580                |
| Jameson, Forbici per dissezione.....                     | 69       | Laccio, Brünings.....                              | 730                | Madrevite zigrinata.....                               | 518                |
| Jameson, Portaghi.....                                   | 412      | Lahey, Divaricatore.....                           | 246                | Magill, Pinza per introdurre le sonde.....             | 388                |
| Jamieson, Tubo di aspirazione.....                       | 377      | Lahey, Pinza per gozzo.....                        | 550                | Maltz, Raspa nasale.....                               | 711, 713           |
| Jansen, Curetta auricolare.....                          | 677      | Lahey, Pinza per vie biliari.....                  | 198                | Mandrino, Guilen.....                                  | 720                |
| Jansen, Divaricatore autostatico.....                    | 281      | Lama da sega.....                                  | 450                | Mango solo, Nabatoff.....                              | 353                |
| Jansen, Pinza auricolare.....                            | 671      | Lama di ricambio, Humby.....                       | 14                 | Manico.....  | 354, 369           |
| Jansen, Pinza-sgorbia.....                               | 523      | Lama di ricambio, Schink.....                      | 14                 | Manico a pila.....                                     | 393                |
| Jeweler mod., Micro pinze per dilatazione.....           | 150      | Lama di ricambio, Silver.....                      | 14                 | Manico a pila.....                                     | 394, 396, 398, 400 |
| Jeweler mod., Micro-Pinza.....                           | 150      | Lama di ricambio, Stille-Martin.....               | 445                | Manico per aspirazione, Coupland.....                  | 378                |
| Johns-Hopkins, Pinza Bulldog.....                        | 163      | Lama intercambiabile.....                          | 462                | Manico per bisturi.....                                | 5-8, 10            |
| Johnson, Portaghi.....                                   | 413      | Lama per bisturi (sterili).....                    | 9                  | Manico per bisturi con testa inclinabile.....          | 6                  |
| Joll, Divaricatore per tiroide e vagina.....             | 303      | Lama per osteotomia, intercambiabile.....          | 462                | Manico per bisturi, Collin.....                        | 6                  |
| Jones, Pinza fissateli.....                              | 211      | Lamotte-Mini, Osteotomo.....                       | 466                | Manico per bisturi, Kaye.....                          | 8                  |
| Joseph-Masing, Elevatore per il periosto.....            | 704      | Lamotte, Osteotomo.....                            | 467-468            | Manico per scalpello.....                              | 462                |
| Joseph, Bisturi per plastica nasale.....                 | 699      | Lamotte, Periostotomo.....                         | 496                | Manico per specchi laringei.....                       | 735                |
| Joseph, Elevatore per il periosto.....                   | 704      | Lampadina di ricambio.....                         | 393                | Manico per specolo vaginale, Scherbak.....             | 609-610            |
| Joseph, Elevatore per il setto nasale.....               | 701      | Landolt, Cannula d' aspirazione.....               | 370                | Manico universale, Huber.....                          | 632                |
| Joseph, Forbici per chirurgia.....                       | 60-61    | Landolt, Periostotomo.....                         | 490                | Manico, Yankauer.....                                  | 372                |
| Joseph, Lima per ossa.....                               | 711      | Lane, Pinza fissateli.....                         | 213                | Marquard, Pinza-sgorbia.....                           | 526                |
| Joseph, Segna nasale.....                                | 709      | Lane, Pinza gastrointestinali gemelle.....         | 568-569            | Martel-Rees, Pinza per Face-lift.....                  | 170                |
| Joseph, Uncino per mucosa.....                           | 715-716  | Lane, Tenaglia per ossa.....                       | 519                | Martello.....  | 477-480            |
| Judd-Allis, Pinza per afferrare intestino e tessuti..... | 557      | Lange-Hohmann, Elevatore per ossa.....             | 505                | Martello, Collin.....                                  | 476                |
| Judd-Masson, Divaricatore vescicale.....                 | 592      | Lange, Pinza intercambiabile.....                  |                    | Martello, Cottle.....                                  | 476                |
|  |          | per bronco-esofagoscopia.....                      | 733                | Martello, Doyen.....                                   | 475                |

|  |                   |  |                        |  |          |
|--|-------------------|--|------------------------|--|----------|
| Martello, Lucae .....                                      | 476               | Meyerding, Divaricatore.....                           | 230                    | Moynihan, Pinza per isterectomia .....                             | 207      |
| Martello, Mead .....                                       | 477               | Michel, Pinza per applicare le graffe .....            | 439                    | Museum, Pinza per il collo dell'utero .....                        | 621      |
| Martello, Partsch .....                                    | 478               | Michel, Pinza per applicare le graffe .....            | 440                    |  |          |
| Martello, Williger.....                                    | 475, 477          | Michel, Specchi laringei.....                          | 735                    | <b>N</b>   |          |
| Martin aquajet, Pistola lavatrice<br>a getto d'acqua.....  | 762               | Micro Ago auricolare, Barbara .....                    | 660-661                | Nabatoff, Fune di trazione.....                                    | 353      |
| Martin aquajet, Raccordo di lavaggio .....                 | 762-763           | Micro Ago auricolare, Rosen .....                      | 660                    | Nabatoff, Mango solo.....  | 353      |
| Martin-Alloy, Diapason .....                               | 667               | Micro cucchiaino, House .....                          | 663                    | Nabatoff, Oliva .....  | 353      |
| Martin-Aseptic, Spazzola per unghie.....                   | 742               | Micro Dissetto, Fisch .....                            | 662                    | Nabatoff, Punta di plastica.....                                   | 353      |
| Martin-Cushing, Periototomo .....                          | 489               | Micro Divaricatore, Graefe.....                        | 226                    | Nabatoff, Set di sonde per varici .....                            | 353      |
| Martin-Fuchs, Pinza per preparazione<br>e legature .....   | 177               | Micro Divaricatore, Rasse.....                         | 226                    | Nägele, Forcipe ostetrica .....                                    | 638      |
| Martin-Hoen, Periototomo.....                              | 488               | Micro Forbici auricolare, Bellucci .....               | 654                    | Negus, Pinza emostatica .....                                      | 203      |
| Martin-Langenbeck, Elevatore .....                         | 500               | Micro Forbici auricolare, Wullstein .....              | 655                    | Neivert-Anderson, Osteotomo.....                                   | 708      |
| Martin-Langenbeck, Periototomo .....                       | 488               | Micro Pinza auricolare.....                            | 648, 650-652           | Neivert, Portaghi .....  | 409      |
| Martin-Rochard, Barra trasversale.....                     | 323               | Micro Pinza auricolare, Mini-McGee.....                | 649, 653               | Neivert, Uncino per le pinne nasali.....                           | 717      |
| Martin-Rochard, Braccio di fissaggio.....                  | 323               | Micro pinze per dilatazione, Jeweler mod.....          | 150                    | Nelaton, Sonda cannellata.....                                     | 351      |
| Martin-Rochard, Carrucola mobile.....                      | 323               | Micro Portaghi.....                                    | 404-405, 415, 417      | Nelson, Pinza per dissezione con denti .....                       | 147      |
| Martin-Rochard, Divaricatore.....                          | 323               | Micro Portaghi, Barraquer.....                         | 406-407, 419           | Neuro, Diapason .....  | 669      |
| Martin-Rochard, Sistema Divaricatore .....                 | 323               | Micro Portaghi, Barraquer-Troutman.....                | 406                    | Norfolk-Norwich, Divaricatore autostatico.....                     | 283      |
| Martin-Rochard, Supporto per divaricatore .....            | 323               | Micro Portaghi, Castroviejo .....                      | 408, 418-419           | Northbent, Forbici per legature.....                               | 107      |
| Martin, Coltello per gesso.....                            | 447               | Micro Portaghi, Castroviejo-Fino .....                 | 407                    | Noto, Pinza per polipi uterini.....                                | 623      |
| Martin, Diapason .....                                     | 667               | Micro Portaghi, Heavy Duty .....                       | 416                    | Novak, Curetta per aspirazione.....                                | 627      |
| Martin, Distributore per spazzole.....                     | 742-743           | Micro Portaghi, Hepp-Scheidel.....                     | 415                    | Nuboer, Tubo di aspirazione .....                                  | 377      |
| Martin, Divaricatore.....                                  | 259               | Micro Portaghi, Jaboma.....                            | 415                    |  |          |
| Martin, Divaricatore autostatico .....                     | 301               | Micro Raspatore auricolare, Rosen .....                | 662                    | <b>O</b>   |          |
| Martin, Forbici per tagliare fili metallico.....           | 124               | Micro Sonda per misurare, House.....                   | 663                    | O'Brian, Forbici per legature .....                                | 107      |
| Martin, Morsetto di fissaggio universale.....              | 322, 323          | Micro Uncino auricolare .....                          | 661-662                | O'Connor, Divaricatore per pelle .....                             | 227      |
| Martin, Pelvimetro .....                                   | 638               | Micro Uncino auricolare, Barbara .....                 | 660                    | O'Shaughnessy, Pinza per preparazione e legature.....              | 195      |
| Martin, Pinza per cartilagine .....                        | 512               | Micro Uncino auricolare, McGee.....                    | 661                    | O'Sullivan-O'Connor, Divaricatore addominale.....                  | 316      |
| Martin, Pinza per medicature.....                          | 219               | Micro Uncino auricolare, Shambaugh .....               | 662                    | O'Sullivan-O'Connor, Valva centrale .....                          | 316      |
| Martin, Pinza per rifiuti .....                            | 768               | Micro-dissetto, Varady .....                           | 352                    | Occhiali protettivi .....  | 746      |
| Martin, Portaghi.....                                      | 423               | Micro-estrattore per flebiti, Varady.....              | 352                    | Ochsner, Pinze porta-filo .....                                    | 438      |
| Martin, Sistema braccio Martin .....                       | 322               | Micro-Forbici.....                                     | 76, 104-105            | Oehler, Pinza per dissezione con denti .....                       | 134      |
| Martin, Spatola addominale .....                           | 348               | Micro-Forbici, Biemer.....                             | 105                    | Ogura, Pinza per afferrare la pelle .....                          | 719      |
| Martin, Specolo nasale .....                               | 681               | Micro-Forbici, corto .....                             | 70                     | Oliva, Nabatoff .....  | 353      |
| Martini, Portaghi .....                                    | 426-427           | Micro-Forbici, Jaboma .....                            | 105                    | Oliva, Yankauer .....  | 372      |
| marTract .....   | 326-339, 341, 345 | Micro-Pinza .....                                      | 129, 141, 149-152, 158 | Olivecrona, Forbici per dissezione .....                           | 79       |
| marTract, Alan-Parks .....                                 | 338               | Micro-Pinza atraumatica .....                          | 151                    | Ollier, Divaricatore .....   | 240      |
| marTract, Breisky .....                                    | 340               | Micro-Pinza per dissezione con anello .....            | 150-152                | Olsen Hegar, Portaghi .....  | 414, 427 |
| marTract, Deaver .....                                     | 337               | Micro-Pinza, Jeweler mod.....                          | 150                    | Osteotomo .....  | 456      |
| marTract, Harrington .....                                 | 339               | Microvascular, Portaghi .....                          | 426                    | Osteotomo, Cinelli .....   | 708      |
| marTract, Kirschner.....                                   | 334               | Middeldorp, Divaricatore .....                         | 252, 256               | Osteotomo, Cottle.....   | 706      |
| marTract, Langenbeck.....                                  | 335-336, 339      | Middleton-Jansen, Pinza per il setto nasale.....       | 694                    | Osteotomo, Hibbs .....   | 471-472  |
| marTract, Richardson .....                                 | 342               | Mikro-Adson, Pinza per dissezione.....                 | 143                    | Osteotomo, Hoke.....   | 471      |
| marTract, Roux.....  | 344               | Mikro-Adson, Pinza per dissezione con denti.....       | 143                    | Osteotomo, Lambotte .....  | 467-468  |
| marTract, St. Marks .....                                  | 343               | Mikro-Adson, Pinza per preparazione e legature .....   | 170                    | Osteotomo, Lambert-Mini .....                                      | 466      |
| marTract, Volkmann.....                                    | 344               | Mikro-Adson, Shigeno, Pinza per dissezione.....        | 143                    | Osteotomo, Lexer .....   | 465      |
| Masing, Elevatore per il periosto.....                     | 704               | Mikro-Mosquito, Pinza emostatica .....                 | 173                    | Osteotomo, Lexer-Mini.....   | 464      |
| Masson, Portaghi .....                                     | 412, 422          | Mikulic-Baby, Pinza per peritoneo.....                 | 209                    | Osteotomo, Neivert-Anderson.....                                   | 708      |
| Mathieu, Divaricatore .....                                | 279               | Mikulic, Divaricatore .....                            | 273                    | Osteotomo, Rubin.....  | 707      |
| Mathieu, Pinza per corpi estranei.....                     | 597               | Mikulic, Divaricatore .....                            | 272                    | Osteotomo, Smith-Petersen .....                                    | 469      |
| Mathieu, Portaghi.....                                     | 414, 428-429      | Mikulic, Pinza per peritoneo.....                      | 209-210                | Osteotomo, Stille.....   | 460-461  |
| Mayfield, Pinza-sgorbia.....                               | 526               | Miller-Baby, Set per laringoscopia.....                | 389                    | Osteotomo, Walter.....   | 707      |
| Mayo-Blake, Pinza per calcoli biliari.....                 | 586               | Miller-Colburn, Lima per ossa .....                    | 498-499                | Overholt-Baby, Pinza per preparazione<br>e legature .....          | 175      |
| Mayo-Harrington, Forbici per dissezione .....              | 29                | Miller, Lima per alveolotomia .....                    | 499                    | Overholt-Fino, Pinza per preparazione<br>e legature .....          | 190      |
| Mayo-Hegar, Portaghi .....                                 | 411, 421          | Miller, Set per laringoscopia.....                     | 389                    | Overholt-Geissendörfer, Pinza per<br>preparazione e legature ..... | 189      |
| Mayo-Lexer, Forbici per dissezione.....                    | 116               | Miller, Set per laringoscopia (luce fredda) .....      | 398                    | Overholt-Martin, Pinza per preparazione<br>e legature .....        | 185      |
| Mayo-Noble, Forbici per dissezione.....                    | 29                | Miller, Spatola per laringoscopia .....                | 389                    | Overholt-Mini, Pinza per preparazione<br>e legature .....          | 191      |
| Mayo-Robson, Pinza intestinale .....                       | 562, 572          | Miller, Spatola per laringoscopia (luce fredda).....   | 398-399                | Overholt-Mixer, Pinza per preparazione<br>e legature .....         | 186      |
| Mayo-Stille, Forbici per dissezione .....                  | 26-28             | Milligan, Divaricatore autostatico.....                | 292                    | Overholt, Pinza per preparazione e legature .....                  | 191      |
| Mayo, Forbici per chirurgia .....                          | 24-25             | Millin, Divaricatore del collo vescicale .....         | 592                    |  |          |
| Mayo, Pinza per dissezione con denti .....                 | 146               | Millin, Divaricatore vescicale.....                    | 593                    |  |          |
| Mayo, Pinze per sterilizzazione.....                       | 754               | Millin, Pinza per afferrare capsule .....              | 590-591                |  |          |
| McDonald, Dissetto doppio.....                             | 501               | Millin, Valva centrale.....                            | 593                    |  |          |
| McGee, Micro Uncino auricolare.....                        | 661               | Millin, Valva laterale.....                            | 593                    |  |          |
| McGee, Pinza per piegare fili metallici.....               | 656               | Mini-Adson, Pinza per dissezione .....                 | 128                    |  |          |
| McGinvey, Pinza per emorroidi .....                        | 582               | Mini-Adson, Pinza per dissezione con denti.....        | 143                    |  |          |
| McIndoe, Pinza per dissezione .....                        | 128, 131          | Mini-clip vascolare .....                              | 161                    |  |          |
| McIntosh, Set per laringoscopia.....                       | 391               | Mini-estrattore per flebiti, Varady.....               | 352                    |  |          |
| McIntosh, Set per laringoscopia (luce fredda) .....        | 394               | Mini-Gemini, Pinza per preparazione e legature .....   | 192                    |  |          |
| McIntosh, Spatola per laringoscopia .....                  | 391               | Mini-Glover, Pinza Bulldog.....                        | 165-166                |  |          |
| McIntosh, Spatola per laringoscopia<br>(luce fredda) ..... | 394-395           | Mini-Glover, Pinza per applicare clips vascolari ..... | 166                    |  |          |
| McKenty, Elevatore per il setto nasale.....                | 701-702           | Mini-McGee, Micro Pinza auricolare.....                | 649, 653               |  |          |
| McQuigg-Mixer, Pinza per preparazione<br>e legature .....  | 197               | Mixer-Baby, Pinza per preparazione<br>e legature.....  | 170, 186, 194          |  |          |
| Mead, Martello .....                                       | 477               | Mixer, Pinza per calcoli biliari.....                  | 587                    |  |          |
| Mead, Pinza-sgorbia.....                                   | 523               | Mixer, Pinza per preparazione e legature .....         | 195-197                |  |          |
| Mead, Placca di ricambio .....                             | 477               | Mock, Ago per eparinea .....                           | 381, 384               |  |          |
| Meeke, Pinza per preparazione e legature.....              | 203               | Mod. Bonn, Forbici per iridectomia .....               | 96                     |  |          |
| Menghini, Cannula per la puntura del fegato .....          | 384               | Mod. Martin, Pinza-coperchio.....                      | 754                    |  |          |
| Metzenbaum-Fino, Forbici fine<br>per dissezione.....       | 53-58, 113, 117   | Mod. Martin, Sonda conduttrice.....                    | 436                    |  |          |
| Metzenbaum-Lahey, Forbici fine per dissezione .....        | 117               | Mod. München, Curetta per biopsia .....                | 627                    |  |          |
| Metzenbaum-Nelson, Forbici per dissezione .....            | 40                | Mod. USA, Forbici ombelicale .....                     | 90                     |  |          |
| Metzenbaum-Thorek, Forbici per dissezione .....            | 115               | Mod. Wien, Specolo nasale .....                        | 682                    |  |          |
| Metzenbaum, Forbici per dissezione.....                    | 37-44             | Modell USA, Curetta tagliente.....                     | 485                    |  |          |
| Metzenbaum, Portaghi .....                                 | 410               | Modell Wien, Porta-legature.....                       | 438                    |  |          |
|  |                   | Mogen, Strumento per circoncisione.....                | 596                    |  |          |
|  |                   | Mollison, Divaricatore autostatico .....               | 289                    |  |          |
|  |                   | Molt, Curetta doppia.....                              | 487                    |  |          |
|  |                   | Morsetto di fissaggio universale, Martin.....          | 322, 323               |  |          |

|  |          |  |                  |  |                   |
|--|----------|--|------------------|--|-------------------|
| Periostotomo .....                                 | 493-494  | Pinza fissateli, Roeder .....                              | 212              | Pinza per calcoli renali, Randall .....              | 584               |
| Periostotomo costali, Doyen .....                  | 495      | Pinza fissateli, Schädcl .....                             | 211              | Pinza per cartilagine, Bircher-Ganske .....          | 511               |
| Periostotomo, Alexander .....                      | 496      | Pinza fissateli, Tohoku .....                              | 212              | Pinza per cartilagine, Dingmann .....                | 511               |
| Periostotomo, Cobb .....                           | 492      | Pinza gastrointestinali gemelle, Lane .....                | 568-569          | Pinza per cartilagine, Martin .....                  | 512               |
| Periostotomo, Cottle .....                         | 490      | Pinza intercambiabile per .....                            |                  | Pinza per columella, Cottle .....                    | 719               |
| Periostotomo, Farabeuf .....                       | 491      | bronco-esofagoscopia, Brünings .....                       | 732-733          | Pinza per corpi estranei, Buck .....                 | 672               |
| Periostotomo, Farabeuf-Collin .....                | 491      | Pinza intercambiabile per .....                            |                  | Pinza per corpi estranei, Mathieu .....              | 597               |
| Periostotomo, Kahre-Williger .....                 | 494      | bronco-esofagoscopia, Cordes .....                         | 733              | Pinza per dissezione .....                           | 126-127, 148      |
| Periostotomo, Key .....                            | 491      | Pinza intercambiabile per .....                            |                  | Pinza per dissezione con denti .....                 | 137-139, 143, 148 |
| Periostotomo, König .....                          | 490      | bronco-esofagoscopia, Fraenkel .....                       | 732              | Pinza per dissezione con denti, Adlerkreutz .....    | 139               |
| Periostotomo, Lambotte .....                       | 496      | Pinza intercambiabile per .....                            |                  | Pinza per dissezione con denti, Adson .....          | 132, 140          |
| Periostotomo, Landolt .....                        | 490      | bronco-esofagoscopia, Krause .....                         | 733              | Pinza per dissezione con denti, .....                |                   |
| Periostotomo, Langenbeck .....                     | 490      | Pinza intercambiabile per bronco-esofagoscopia, .....      |                  | Adson-Brown .....                                    | 132, 142          |
| Periostotomo, Martin-Cushing .....                 | 489      | Lange .....  | 733              | Pinza per dissezione con denti, Bonney .....         | 131, 146          |
| Periostotomo, Martin-Hoen .....                    | 488      | Pinza intercambiabile per .....                            |                  | Pinza per dissezione con denti, Cushing .....        | 142               |
| Periostotomo, Martin-Langenbeck .....              | 488      | bronco-esofagoscopia, Seiffert .....                       | 732              | Pinza per dissezione con denti, Durante .....        | 145               |
| Periostotomo, Sedillot .....                       | 490      | Pinza intestinale, Allen .....                             | 564              | Pinza per dissezione con denti, Gerald .....         | 131, 142          |
| Periostotomo, Semb .....                           | 496      | Pinza intestinale, Doyen .....                             | 560              | Pinza per dissezione con denti, Gillies .....        | 131, 140          |
| Periostotomo, Williger .....                       | 494      | Pinza intestinale, Doyen-Baby .....                        | 561, 571         | Pinza per dissezione con denti, Jaboma .....         | 135               |
| Pesi, Rydel-Seiffert .....                         | 669      | Pinza intestinale, Kocher .....                            | 563-564, 573-574 | Pinza per dissezione con denti, Mayo .....           | 146               |
| Peso per specolo vaginale, Auvar .....             | 611      | Pinza intestinale, Mayo-Robson .....                       | 562, 572         | Pinza per dissezione con denti, Mikro-Adson .....    | 143               |
| Peso per specolo vaginale, Scherbak .....          | 610      | Pinza intestinale, Scudder .....                           | 575              | Pinza per dissezione con denti, Mini-Adson .....     | 143               |
| Pestalozza, Cucchiato per placenta e ovaie .....   | 642      | Pinza micro con contrapeso .....                           | 150              | Pinza per dissezione con denti, Nelson .....         | 147               |
| Pestone metallico .....                            | 474      | Pinza osteotomo, Beyer .....                               | 675              | Pinza per dissezione con denti, Oehler .....         | 134               |
| Pestone metallico, Caspar .....                    | 474      | Pinza osteotomo, Citelli .....                             | 674              | Pinza per dissezione con denti, Potts-Smith .....    | 142               |
| Pezzo di collegamento .....                        | 636      | Pinza passa-tendini .....                                  | 509              | Pinza per dissezione con denti, Resano .....         | 147               |
| Phaneuf, Pinza per isterectomia .....              | 204      | Pinza passa-tendini, Brand .....                           | 509              | Pinza per dissezione con denti, Russ, Modell .....   | 145               |
| Pinza atraumatica .....                            | 130      | Pinza per afferrare capsule, Millin .....                  | 590-591          | Pinza per dissezione con denti, Semken .....         | 131, 140          |
| Pinza atraumatica, DeBakey .....                   | 135-136  | Pinza per afferrare e rompere le lamette .....             |                  | Pinza per dissezione con denti, Singley-Tuttle ..... | 146               |
| Pinza atraumatica, Gerald .....                    | 136      | de rasoio, Castroviejo .....                               | 4                | Pinza per dissezione con denti, Stille .....         | 139               |
| Pinza auricolare, Grünwald .....                   | 671      | Pinza per afferrare e rompere le lamette .....             |                  | Pinza per dissezione con denti, Stille-Barraya ..... | 145               |
| Pinza auricolare, Jansen .....                     | 671      | de rasoio, Troutman-Chris .....                            | 4                | Pinza per dissezione con denti, Taylor .....         | 141               |
| Pinza auricolare, Tröltzsch (Wilde) .....          | 671      | Pinza per afferrare intestino e tessuti, Allis .....       | 556-557          | Pinza per dissezione con denti, Waugh .....          | 140               |
| Pinza Bulldog .....                                | 162      | Pinza per afferrare intestino e tessuti, Allis-Adair ..... | 557              | Pinza per dissezione, Adson .....                    | 128, 132          |
| Pinza Bulldog, DeBakey-Diethrich .....             | 164      | Pinza per afferrare intestino e tessuti, Allis-Baby .....  | 556              | Pinza per dissezione, Bonney .....                   | 127               |
| Pinza Bulldog, Dieffenbach .....                   | 162      | Pinza per afferrare intestino e tessuti, Babcock .....     | 558-559          | Pinza per dissezione, Cushing .....                  | 130, 133          |
| Pinza Bulldog, Diethrich .....                     | 164      | Pinza per afferrare intestino e tessuti, Boys-Allis .....  | 557              | Pinza per dissezione, Cushing-Taylor .....           | 133               |
| Pinza Bulldog, Johns-Hopkins .....                 | 163      | Pinza per afferrare intestino e tessuti, Duval .....       | 559-560          | Pinza per dissezione, Gerald .....                   | 130               |
| Pinza Bulldog, Mini-Glover .....                   | 165-166  | Pinza per afferrare intestino e tessuti, Judd-Allis .....  | 557              | Pinza per dissezione, Jaboma .....                   | 135               |
| Pinza con rotelle, Brompton .....                  | 215      | Pinza per afferrare intestino e tessuti, Lockwood .....    | 556              | Pinza per dissezione, Kübler .....                   | 134               |
| Pinza con rotelle, Gunnar-Hey .....                | 215      | Pinza per afferrare intestino e tessuti, Thoms-Allis ..... | 557              | Pinza per dissezione, McIndoe .....                  | 128, 131          |
| Pinza contundente per il setto nasale .....        | 694      | Pinza per afferrare intestino e tessuti, Williams .....    | 558              | Pinza per dissezione, Mikro-Adson .....              | 143               |
| Pinza contundente per il setto nasale, Rubin ..... | 695      | Pinza per afferrare l'utero, Collin .....                  | 625              | Pinza per dissezione, Mikro-Adson, Shigeno .....     | 143               |
| Pinza da orologio .....                            | 144      | Pinza per afferrare l'utero, Dartigues .....               | 625              | Pinza per dissezione, Mini-Adson .....               | 128               |
| Pinza depilatoria .....                            | 155      | Pinza per afferrare l'utero, Somer .....                   | 625              | Pinza per dissezione, Potts-Smith .....              | 130, 133          |
| Pinza depilatoria, Barraquer .....                 | 155      | Pinza per afferrare organi, Scheibe .....                  | 570              | Pinza per dissezione, Schweden-Modell .....          | 128               |
| Pinza depilatoria, Beer .....                      | 155      | Pinza per afferrare la pelle, Cottle .....                 | 719              | Pinza per dissezione, Semken .....                   | 129               |
| Pinza depilatoria, Douglas .....                   | 155      | Pinza per afferrare la pelle, Oigura .....                 | 719              | Pinza per dissezione, Taylor .....                   | 129               |
| Pinza depilatoria, Littauer .....                  | 155      | Pinza per afferrare organi .....                           | 168              | Pinza per dissezione, Wangensteen .....              | 134               |
| Pinza emostatica, Bengolea .....                   | 180      | Pinza per afferrare organi, Collin .....                   | 169              | Pinza per dissezione, Waugh .....                    | 128               |
| Pinza emostatica, Chaput .....                     | 168      | Pinza per afferrare tendini .....                          | 510              | Pinza per DIU .....                                  | 632               |
| Pinza emostatica, Crile .....                      | 175      | Pinza per afferrare tendini, Carroll .....                 | 509              | Pinza per emorroidi, McGinvey .....                  | 582               |
| Pinza emostatica, Crile-Rankin .....               | 176      | Pinza per afferrare tendini, Kleinert-Kutz .....           | 510              | Pinza per Face-lift, Martel-Rees .....               | 170               |
| Pinza emostatica, Dandy .....                      | 176      | Pinza per afferrare tendini, Steinmann .....               | 509              | Pinza per gesso, Hennig .....                        | 448               |
| Pinza emostatica, Dandy-Mosquito .....             | 176      | Pinza per afferrare tubi, Hepp-Scheidel .....              | 147              | Pinza per gesso, Quattro .....                       | 448               |
| Pinza emostatica, Dunhill .....                    | 174      | Pinza per afferrare tumori, Collin .....                   | 169              | Pinza per gozzo, Lahey .....                         | 550               |
| Pinza emostatica, Halsted-Mosquito .....           | 171-172  | Pinza per allacciare tendini .....                         | 510              | Pinza per i margini della ferita, Child .....        | 439               |
| Pinza emostatica, Hartmann .....                   | 171      | Pinza per anastomosi intestinali, .....                    |                  | Pinza per il collo dell'utero .....                  | 622               |
| Pinza emostatica, Kelly .....                      | 174      | De Martel-Wolfson .....                                    | 566              | Pinza per il collo dell'utero, Braun .....           | 619, 622          |
| Pinza emostatica, Kelly-Rankin .....               | 175      | Pinza per anastomosi rettili, Brunner .....                | 575              | Pinza per il collo dell'utero, Czerny .....          | 622               |
| Pinza emostatica, Kocher .....                     | 179      | Pinza per anastomosi rettili, Fehland .....                | 577              | Pinza per il collo dell'utero, Duplay .....          | 619               |
| Pinza emostatica, Kocher (Ochsner) .....           | 183-184  | Pinza per anastomosi rettili, Hayes .....                  | 576              | Pinza per il collo dell'utero, Iowa .....            | 621               |
| Pinza emostatica, Kocher-Nippon .....              | 179      | Pinza per anastomosi rettili, Hayano .....                 | 578              | Pinza per il collo dell'utero, Jacobs .....          | 621               |
| Pinza emostatica, Leriche .....                    | 173      | Pinza per anastomosi rettili, Veidenheimer .....           | 577              | Pinza per il collo dell'utero, Museux .....          | 621               |
| Pinza emostatica, Lovelace .....                   | 176      | Pinza per applicare clips vascolari .....                  | 158              | Pinza per il collo dell'utero, Schröder .....        | 619-620           |
| Pinza emostatica, Mikro-Mosquito .....             | 173      | Pinza per applicare clips vascolari .....                  | 161              | Pinza per il collo dell'utero, Skene .....           | 620               |
| Pinza emostatica, Negus .....                      | 203      | Pinza per applicare clips vascolari, Mini-Glover .....     | 166              | Pinza per il collo dell'utero, Teale .....           | 620               |
| Pinza emostatica, Pean .....                       | 167, 178 | Pinza per applicare le graffe, Hegenbarth .....            | 439              | Pinza per il setto nasale .....                      | 670               |
| Pinza emostatica, Pean (Rochester) .....           | 181-182  | Pinza per applicare le graffe, Michel .....                | 439              | Pinza per il setto nasale .....                      | 687               |
| Pinza emostatica, Pean-Nippon .....                | 178      | Pinza per applicare le graffe, Michel .....                | 440              | Pinza per il setto nasale, Brünings .....            | 687               |
| Pinza emostatica, Pennington .....                 | 169      | Pinza per applicare le graffe, Richter .....               | 440              | Pinza per il setto nasale, Caplan .....              | 694               |
| Pinza emostatica, Providence-Hospital .....        | 173      | Pinza per applicare le graffe, Wachenfeldt .....           | 439              | Pinza per il setto nasale, Graig .....               | 687               |
| Pinza emostatica, Rochester-Carmalt .....          | 177      | Pinza per biopsia rettale .....                            | 582              | Pinza per il setto nasale, Knight .....              | 687               |
| Pinza emostatica, Spencer-Wells .....              | 167      | Pinza per biopsia, Alexander .....                         | 631              | Pinza per il setto nasale, Kressner .....            | 718               |
| Pinza emostatica, Tuffier .....                    | 168      | Pinza per biopsia, Faure .....                             | 628              | Pinza per il setto nasale, Middleton-Jansen .....    | 694               |
| Pinza emostatiche per tagli cesarei, .....         |          | Pinza per biopsia, Gellhorn .....                          | 628              | Pinza per introdurre le sonde, Magill .....          | 388               |
| Green-Armytage .....                               | 640      | Pinza per biopsia, Kevorkian .....                         | 631              | Pinza per introduzione, Fuller .....                 | 658               |
| Pinza etmoidale .....                              | 689      | Pinza per biopsia, Schubert .....                          | 628-629          | Pinza per isterectomia, Heaney .....                 | 204               |
| Pinza etmoidale, Takahashi .....                   | 688      | Pinza per biopsia, Schumacher .....                        | 631-632          | Pinza per isterectomia, Moynihan .....               | 207               |
| Pinza etmoidale, Watson-Williams .....             | 689      | Pinza per biopsia, Thoms-Gaylor .....                      | 629              | Pinza per isterectomia, Phaneuf .....                | 204               |
| Pinza etmoidale, Weil-Blakesley .....              | 690      | Pinza per biopsia, Van Doren .....                         | 630              | Pinza per isterectomia, Rogers .....                 | 206               |
| Pinza fissateli .....                              | 213      | Pinza per calcoli biliari, Blake .....                     | 586              | Pinza per isterectomia, Wertheim .....               | 208               |
| Pinza fissateli, Backhaus .....                    | 211      | Pinza per calcoli biliari, Desjardins .....                | 587              | Pinza per legature .....                             | 171               |
| Pinza fissateli, Bernhard .....                    | 212      | Pinza per calcoli biliari, Mayo-Blake .....                | 586              | Pinza per medicature, Bryant .....                   | 219               |
| Pinza fissateli, Jones .....                       | 211      | Pinza per calcoli biliari, Mixer .....                     | 587              | Pinza per medicature, Cheron .....                   | 221               |
| Pinza fissateli, Lane .....                        | 213      | Pinza per calcoli renali, Heimung .....                    | 584              | Pinza per medicature, Collin .....                   | 221               |
| Pinza fissateli, Lorna .....                       | 212      |  |                  | Pinza per medicature, Gross-Maier .....              | 220               |
| Pinza fissateli, Peers-Bertram .....               | 213      |  |                  | Pinza per medicature, Grünwald (Jansen) .....        | 686               |
| Pinza fissateli, Peers-Bertram modif. ....         | 212      |  |                  | Pinza per medicature, Martin .....                   | 219               |

|  |               |
|--|---------------|
| Pinza per medicature, Trölsch .....                              | 686           |
| Pinza per peduncoli renali, Guyon .....                          | 199-200       |
| Pinza per peritoneo, Fauré .....                                 | 210           |
| Pinza per peritoneo, Mikulicz .....                              | 209-210       |
| Pinza per peritoneo, Mikulicz-Baby .....                         | 209           |
| Pinza per piegare fili metallici, McGee .....                    | 656           |
| Pinza per placenta e per ovaie, Sängér .....                     | 640           |
| Pinza per placenta e per ovaie, Winter .....                     | 640           |
| Pinza per polipi auricolari, Hartmann .....                      | 672-673       |
| Pinza per polipi auricolari, Hartmann-Herzfeld .....             | 673           |
| Pinza per polipi auricolari, Hartmann-Hoffmann .....             | 673           |
| Pinza per polipi auricolari, Hartmann-Wullstein .....            | 673           |
| Pinza per polipi auricolari, Strümpel .....                      | 673           |
| Pinza per polipi nasali, Hartmann .....                          | 686           |
| Pinza per polipi uterini, Heywood-Smith .....                    | 623           |
| Pinza per polipi uterini, Kelly .....                            | 623           |
| Pinza per polipi uterini, Noto .....                             | 623           |
| Pinza per preparazione e legature, Adson .....                   | 177           |
| Pinza per preparazione e legature, Adson-Baby .....              | 186           |
| Pinza per preparazione e legature, Baby-Adson .....              | 170           |
| Pinza per preparazione e legature, Craford .....                 | 188           |
| Pinza per preparazione e legature, Finochietto .....             | 198           |
| Pinza per preparazione e legature, Gemini .....                  | 192           |
| Pinza per preparazione e legature, Heiss .....                   | 186           |
| Pinza per preparazione e legature, Kelly .....                   | 202           |
| Pinza per preparazione e legature, Lawrence .....                | 203           |
| Pinza per preparazione e legature, Lower .....                   | 198           |
| Pinza per preparazione e legature, Martin-Fuchsig .....          | 177           |
| Pinza per preparazione e legature, McQuigg-Mixter .....          | 197           |
| Pinza per preparazione e legature, Meeker .....                  | 203           |
| Pinza per preparazione e legature, Mikro-Adson .....             | 170           |
| Pinza per preparazione e legature, Mini-Gemini .....             | 192           |
| Pinza per preparazione e legature, Mixter .....                  | 195-197       |
| Pinza per preparazione e legature, Mixter-Baby .....             | 170, 186, 194 |
| Pinza per preparazione e legature, O'Shaughnessy .....           | 195           |
| Pinza per preparazione e legature, Overholt .....                | 191           |
| Pinza per preparazione e legature, Overholt-Baby .....           | 175           |
| Pinza per preparazione e legature, Overholt-Fino .....           | 190           |
| Pinza per preparazione e legature, Overholt-Geissendörfer .....  | 189           |
| Pinza per preparazione e legature, Overholt-Martin .....         | 185           |
| Pinza per preparazione e legature, Overholt-Mini .....           | 191           |
| Pinza per preparazione e legature, Overholt-Mixter .....         | 186           |
| Pinza per preparazione e legature, Roberts .....                 | 187           |
| Pinza per preparazione e legature, Rumel .....                   | 193           |
| Pinza per preparazione e legature, Sarot .....                   | 187           |
| Pinza per preparazione e legature, Schnidt .....                 | 177           |
| Pinza per preparazione e legature, Wikstroem .....               | 196           |
| Pinza per preparazione e legature, Zenker .....                  | 194           |
| Pinza per raddizzare il setto nasale, Asch .....                 | 718           |
| Pinza per raddizzare il setto nasale, Cottle-Walsham .....       | 718           |
| Pinza per rifiuti, Martin .....                                  | 768           |
| Pinza per rifiuti, Sauerbruch .....                              | 768           |
| Pinza per riposizioni .....                                      | 512           |
| Pinza per riposizioni .....                                      | 512, 514      |
| Pinza per rompere gesso, Wolff .....                             | 449           |
| Pinza per scheggie .....   | 153-154       |
| Pinza per scheggie, Feilchenfeld .....                           | 154           |
| Pinza per scheggie, Hunter .....                                 | 154           |
| Pinza per scheggie, Peet .....                                   | 156           |
| Pinza per scheggie, Stieglitz .....                              | 156           |
| Pinza per seni, Lister .....                                     | 219           |
| Pinza per strumenti sterilizzazione .....                        | 750           |
| Pinza per strumenti sterilizzazione, Cheattle .....              | 750           |
| Pinza per tamponamenti nasali, Lubet-Barbon .....                | 686           |
| Pinza per tamponamenti nasali, Westmacott .....                  | 686           |
| Pinza per tamponi e sponge, Bergmann .....                       | 222           |
| Pinza per tamponi e sponge, Bozemann .....                       | 221           |
| Pinza per tamponi e sponge, Förster .....                        | 222-223       |
| Pinza per tamponi e sponge, Rampley .....                        | 223           |
| Pinza per tamponi, Ulrich .....                                  | 218           |
| Pinza per testa del martelletto, House-Dieter .....              | 657           |
| Pinza per tonsille, Blohmke .....                                | 729           |
| Pinza per tonsille, Hartmann .....                               | 731           |
| Pinza per tonsille, Schnidt .....                                | 729           |
| Pinza per tonsille, White .....                                  | 729           |
| Pinza per tunnelare .....  | 220           |
| Pinza per vie biliari, Desjardins .....                          | 201           |
| Pinza per vie biliari, Lahey .....                               | 198           |
| Pinza serratubi .....  | 213-214       |
| Pinza tagliente per il naso, Hartmann .....                      | 693           |
| Pinza tagliente per il naso, Struycken .....                     | 691           |
| Pinza tagliente per il naso, Weil .....                          | 689           |
| Pinza tagliente per il naso, Weil-Blakesley .....                | 690           |
| Pinza tagliente per seno mascellare .....                        | 692           |
| Pinza tagliente per seno mascellare, Kerrison .....              | 698           |
| Pinza tagliente per seno sfenoidale, Ferris-Smith-Kerrison ..... | 697           |
| Pinza tagliente per seno sfenoidale, Hajek .....                 | 696           |
| Pinza tangenziali, Uro-Tangential .....                          | 199           |
| Pinza vaginale, Wertheim-Cullen .....                            | 205           |
| Pinza-coperchio, Mod. Martin .....                               | 754           |
| Pinza-sgorbia .....  | 524           |
| Pinza-sgorbia, Beyer .....                                       | 525           |
| Pinza-sgorbia, Blumenthal .....                                  | 524           |
| Pinza-sgorbia, Böhrer .....                                      | 525           |
| Pinza-sgorbia, Cleveland .....                                   | 522           |
| Pinza-sgorbia, Echlin .....                                      | 527           |
| Pinza-sgorbia, Friedmann .....                                   | 522           |
| Pinza-sgorbia, Frykholm .....                                    | 528           |
| Pinza-sgorbia, Hartmann .....                                    | 523           |
| Pinza-sgorbia, Jansen .....                                      | 523           |
| Pinza-sgorbia, Leksell-Stille .....                              | 528           |
| Pinza-sgorbia, Lempert .....                                     | 523           |
| Pinza-sgorbia, Luer .....  | 525           |
| Pinza-sgorbia, Marquard .....                                    | 526           |
| Pinza-sgorbia, Mayfield .....                                    | 526           |
| Pinza-sgorbia, Mead .....  | 523           |
| Pinza-sgorbia, Ruskin .....                                      | 526           |
| Pinza-sgorbia, Semb .....  | 526           |
| Pinza-sgorbia, Stellbrink .....                                  | 522           |
| Pinza-sgorbia, Stille .....                                      | 526           |
| Pinza-sgorbia, Stille-Luer .....                                 | 529           |
| Pinza-sgorbia, Stille-Ruskin .....                               | 527           |
| Pinza-sgorbia, Zaufal-Jansen .....                               | 525           |
| Pinze per calcoli biliari, Luer-Körte .....                      | 588           |
| Pinze per sterilizzazione, Mayo .....                            | 754           |
| Pinze porta-filo, Ochsner .....                                  | 438           |
| Piper, Forcipe obstetrica .....                                  | 639           |
| Pistola lavatrice a getto d'acqua, Martin aquajet .....          | 762           |
| Piuma, Low-Profile .....   | 302           |
| Placca di ricambio, Mead .....                                   | 477           |
| Placca per stendere la pelle, Schink .....                       | 14            |
| Placche di ricambio .....  | 478-479       |
| Plester, Cannula di aspirazione .....                            | 383           |
| Plester, Coltello per lobi .....                                 | 659           |
| Plester, Divaricatore autostatico .....                          | 290           |
| Politzer, Ago per timpano .....                                  | 678           |
| Poole, Tubo di aspirazione .....                                 | 373           |
| Poppen, Cannula d' aspirazione .....                             | 367           |
| Porta-legature, Modell Wien .....                                | 438           |
| Portacottone, Farrell .....                                      | 355           |
| Portaghi, Adson .....  | 410           |
| Portaghi, Bozemann .....   | 425           |
| Portaghi, Brown .....  | 410           |
| Portaghi, Collier .....  | 409           |
| Portaghi, Crile .....  | 414           |
| Portaghi, Crile-Murray .....                                     | 410           |
| Portaghi, Crile-Wood .....                                       | 410, 415, 420 |
| Portaghi, DeBakey .....  | 422           |
| Portaghi, Derf .....   | 409, 419      |
| Portaghi, Finochietto .....                                      | 412, 423      |
| Portaghi, Foster-Gillies .....                                   | 428           |
| Portaghi, Gillies .....  | 414, 428      |
| Portaghi, Gillies-Mini .....                                     | 428           |
| Portaghi, Halsey .....   | 409, 420      |
| Portaghi, Heaney .....   | 411, 422      |
| Portaghi, Hegar .....  | 425           |
| Portaghi, Hegar-Baumgartner .....                                | 410, 420      |
| Portaghi, Hegar-Vascular .....                                   | 425           |
| Portaghi, Jameson .....  | 412           |
| Portaghi, Johnson .....  | 413           |
| Portaghi, Kilner .....   | 419           |
| Portaghi, Kübler .....   | 430           |
| Portaghi, Langenbeck .....                                       | 430           |
| Portaghi, M. G. Hospital .....                                   | 411           |
| Portaghi, Martin .....   | 423           |
| Portaghi, Martini .....  | 426-427       |
| Portaghi, Masson .....   | 412, 422      |
| Portaghi, Mathieu .....  | 414, 428-429  |
| Portaghi, Mayo-Hegar .....                                       | 411, 421      |
| Portaghi, Metzénbaum .....                                       | 410           |
| Portaghi, Microvascular .....                                    | 426           |
| Portaghi, Neivert .....  | 409           |
| Portaghi, Olsen Hegar .....                                      | 414, 427      |
| Portaghi, Par-Style .....  | 416           |
| Portaghi, Ryder (Martin) .....                                   | 423           |
| Portaghi, Ryder-Vascular .....                                   | 424           |
| Portaghi, Sarot .....  | 421           |
| Portaghi, Stratte .....  | 413, 426      |
| Portaghi, Toennis .....  | 429           |
| Portaghi, Wangenstein .....                                      | 413, 424      |
| Portaghi, Webster .....  | 409, 415, 419 |
| Portapinze, De Martel-Wolfson .....                              | 567           |
| Potts-Smith, Forbici vascolare .....                             | 74-75         |
| Potts-Smith, Pinza per dissezione .....                          | 130, 133      |
| Potts-Smith, Pinza per dissezione con denti .....                | 142           |
| Pratt, Specolo rettale .....                                     | 579           |
| Providence-Hospital, Pinza emostatica .....                      | 173           |
| Punta di plastica, Nabatoff .....                                | 353           |
| Punta per aspirazione, Coupland .....                            | 378           |
| Punta per aspirazione, Wullstein .....                           | 368           |
| Punta per aspirazione, Yankauer .....                            | 372           |
| Punta per aspirazione, Zoellner .....                            | 368           |
| Punta, sola, Schumacher .....                                    | 632           |
| Putti, Raspa per ossa .....                                      | 473           |
| <b>Q</b>   |               |
| Quattro, Pinza per gesso .....                                   | 448           |
| Quervain, Elevatore .....  | 501           |
| <b>R</b>   |               |
| Raccordo .....   | 385           |
| Raccordo di lavaggio, Martin aquajet .....                       | 762-763       |
| Raccordo per tubi .....  | 385           |
| Ragnell-Davis, Divaricatore .....                                | 231           |
| Ragnell, Forbici per dissezione .....                            | 123           |
| Rampley, Pinza per tamponi e sponge .....                        | 223           |
| Randall, Pinza per calcoli renali .....                          | 584           |
| Raspa nasale, Cottle .....                                       | 711           |
| Raspa nasale, Fomon .....  | 712, 714      |
| Raspa nasale, Lewis .....  | 712           |
| Raspa nasale, Maltz .....  | 711, 713      |
| Raspa per glabella, Aufrecht .....                               | 712           |
| Raspa per ossa, Putti .....                                      | 473           |
| Raspatore per palato, Krenkel .....                              | 701           |
| Raspatorio auricolare, Lempert .....                             | 679           |
| Raspatorio con aspiratore, Guilen .....                          | 720           |
| Rasse, Divaricatore per ossa .....                               | 226           |
| Rasse, Micro Divaricatore .....                                  | 226           |
| Recamier, Curetta uterina .....                                  | 634           |
| Recipiente metallico .....                                       | 759           |
| Redon, Ago conduttore .....                                      | 379-380       |
| Rees, Forbici per Face-lift .....                                | 119           |
| Resano, Pinza per anastomosi rettili .....                       | 578           |
| Resano, Pinza per dissezione con denti .....                     | 147           |
| Retrattore per amputazione, Percy .....                          | 521           |
| Reynolds, Forbici per dissezione .....                           | 67-68         |
| Ricard, Divaricatore addominale .....                            | 307           |
| Ricard, Divaricatore, solo .....                                 | 307           |
| Ricard, Valva centrale .....                                     | 307           |
| Richardson-Eastman, Divaricatore .....                           | 252           |
| Richardson, Divaricatore .....                                   | 253           |
| Richardson, marTract .....                                       | 342           |
| Richter, Pinza per applicare le graffe .....                     | 440           |
| Ritter-Halle, Dilatatore per il seno frontale .....              | 720           |
| Roberts, Pinza per preparazione e legature .....                 | 187           |
| Rochester-Carmalt, Pinza emostatica .....                        | 177           |
| Roeder, Pinza fissatili .....                                    | 212           |
| Roger, Elevatore per il periosto .....                           | 704           |
| Rogers, Pinza per isterectomia .....                             | 206           |
| Rose, Uncino tracheale .....                                     | 549           |
| Rosen, Coltello cirocolare .....                                 | 659           |
| Rosen, Micro Ago auricolare .....                                | 660           |
| Rosen, Micro Raspatore auricolare .....                          | 662           |
| Ross, Divaricatore per aorta .....                               | 265           |
| Roux-Baby, Divaricatore .....                                    | 277           |
| Roux-Mini, Divaricatore .....                                    | 277           |
| Roux, Divaricatore .....   | 276           |
| Roux, marTract .....   | 344           |
| Rubin, Calotta protettiva .....                                  | 695           |
| Rubin, Osteotomo .....   | 707           |
| Rubin, Pinza confondente per il setto nasale .....               | 695           |
| Rubinetto .....  | 385           |
| Rubinetto a tre vie .....  | 385           |
| Rumel, Pinza per preparazione e legature .....                   | 193           |
| Ruskin-Liston, Cesioia per ossa .....                            | 532           |
| Ruskin, Pinza-sgorbia .....                                      | 526           |
| Russ, Modell, Pinza per dissezione con denti .....               | 145           |
| Rydel-Seiffert, Diapason .....                                   | 669           |
| Rydel-Seiffert, Pesi .....                                       | 669           |
| Rydel-Seiffert, Sordina .....                                    | 669           |
| Rydel-Seiffert, Vite a testa zigrinata .....                     | 669           |
| Ryder (Martin), Portaghi .....                                   | 423           |
| Ryder-Vascular, Portaghi .....                                   | 424           |

|   |          |  |          |
|---|----------|--|----------|
| <b>S</b>  |          |  |          |
| Salzer, Dissettore per palato .....                               | 726      | Serranodi per tonsille, Brünings .....                     | 730      |
| Salzer, Elevatore per palato .....                                | 726      | Serranodi per tonsille, Eves .....                         | 730      |
| Salzer, Forbici per dissezione .....                              | 59, 107  | Serranodi per tonsille, Tyding .....                       | 730      |
| Salzer, Forbici per Face-lift .....                               | 107      | Serranodi, Krause .....                                    | 670, 684 |
| Salzer, Uncino per palato .....                                   | 726      | Serranodi, Krause-Voss .....                               | 670, 684 |
| Sänger, Pinza per placenta e per ovaie .....                      | 640      | Serrapene, Stockmann .....                                 | 598      |
| Sanvenero, Forbici per chirurgia .....                            | 59       | Serrapene, Strauss .....                                   | 598      |
| Sarot, Pinza per preparazione e legature .....                    | 187      | Serrapinze, De Martel-Wolfson .....                        | 566      |
| Sarot, Portaghi .....   | 421      | Set di manicura per infermieri .....                       | 744      |
| Satinsky, Forbici vascolare .....                                 | 71       | Set di sonde per varici, Nabatoff .....                    | 353      |
| Sauerbruch, Divaricatore .....                                    | 264      | Set per laringoscopia (luce fredda), Foregger .....        | 396      |
| Sauerbruch, Pinza per rifiuti .....                               | 768      | Set per laringoscopia (luce fredda), McIntosh .....        | 394      |
| Sauerbruch, Scatola per aghi .....                                | 751      | Set per laringoscopia (luce fredda), Miller .....          | 398      |
| Scalp-Contour, Divaricatore automatico .....                      | 282      | Set per laringoscopia, Foregger .....                      | 391-392  |
| Scalpellini per spongiosa, Lexer .....                            | 463      | Set per laringoscopia, Guedel-Negus .....                  | 390      |
| Scalpello .....   | 457      | Set per laringoscopia, McIntosh .....                      | 391      |
| Scalpello .....   | 456      | Set per laringoscopia, Miller .....                        | 389      |
| Scalpello nasale, Silver .....                                    | 708      | Set per laringoscopia, Miller-Baby .....                   | 389      |
| Scalpello per il setto nasale, Freer .....                        | 705      | Sfincteroscopia, Kelly .....                               | 581      |
| Scalpel, Alexander .....  | 459      | Sgorbia .....  | 457      |
| Scalpello, Fomon .....  | 707      | Sgorbia per il setto nasale, Ballenger .....               | 705      |
| Scalpello, Hibbs .....  | 471      | Sgorbia per il setto nasale, Freer .....                   | 705      |
| Scalpello, Partsch .....  | 458      | Sgorbia per il setto nasale, Killian .....                 | 705      |
| Scalpello, Stille .....   | 460      | Sgorbia per il setto nasale, Killian-Claus .....           | 705      |
| Scatola per aghi .....  | 752      | Sgorbia, Alexander .....                                   | 459      |
| Scatola per aghi, Sauerbruch .....                                | 751-753  | Sgorbia, Cobb .....  | 470      |
| Scatola per laringoscopia .....                                   | 393      | Sgorbia, Hibbs .....                                       | 472      |
| Scatola per strumenti .....                                       | 760      | Sgorbia, Lexer .....                                       | 465      |
| Scatola per strumenti .....                                       | 759      | Sgorbia, Lexer-Mini .....                                  | 464      |
| Schädel, Pinza fissatili .....                                    | 211      | Sgorbia, Partsch .....                                     | 458      |
| Schede, Curetta tagliente .....                                   | 482      | Sgorbia, Stille .....                                      | 461      |
| Scheibe, Pinza per afferare organi .....                          | 570      | Sgorbia, Walter .....                                      | 707      |
| Scherbak, Manico per specolo vaginale .....                       | 609, 610 | Sgorbia, Zuelke .....                                      | 459      |
| Scherbak, Peso per specolo vaginale .....                         | 610      | Shambaugh, Micro Uncino auricolare .....                   | 662      |
| Scherbak, Specolo vaginale .....                                  | 610      | Shapleigh, Curetta auricolare .....                        | 676      |
| Scherbak, Valva vaginale, sola .....                              | 609      | Shea Vein Graft, Forbici per dissezione .....              | 64       |
| Schiacciatore intestinale, Payr .....                             | 565      | Shea, Uncino di sondaggio .....                            | 662      |
| Schiacciatore intestinale, Payr-Baby .....                        | 565      | Siebert, Forbici fine per dissezione .....                 | 117      |
| Schink, Dermatomo .....   | 14       | Silver, Dermatomo a mano .....                             | 14       |
| Schink, Lama di ricambio .....                                    | 14       | Silver, Lama di ricambio .....                             | 14       |
| Schink, Placca per stendere la pelle .....                        | 14       | Silver, Scalpello nasale .....                             | 708      |
| Schmid, Cannula per irrigazione vascolare .....                   | 384      | Simon, Curetta tagliente .....                             | 484      |
| Schmieden-Dick, Ago per legatura .....                            | 431      | Simon, Curetta uterina .....                               | 633      |
| Schmieden-Payr, Sonda conduttrice .....                           | 436      | Simon, Divaricatore .....                                  | 259      |
| Schmieden-Taylor, Forbici vascolare .....                         | 77       | Simon, Uncino per fistole .....                            | 626      |
| Schmieden, Ago per legatura .....                                 | 431      | Simpson, Forcipe obstetrica .....                          | 638      |
| Schmieden, Sonda conduttrice .....                                | 436      | Sims-Siebold, Forbici per ginecologia .....                | 35       |
| Schnidt, Pinza per preparazione e legature .....                  | 177      | Sims, Curetta uterina .....                                | 634      |
| Schnidt, Pinza per tonsille .....                                 | 729      | Sims, Forbici per ginecologia .....                        | 30-31    |
| Schröder, Curetta uterina .....                                   | 633      | Sims, Isterometro .....                                    | 618      |
| Schröder, Pinza per il collo dell'utero .....                     | 619-620  | Sims, Specolo rettale .....                                | 579      |
| Schubert, Pinza per biopsia .....                                 | 628-629  | Sims, Specolo vaginale .....                               | 602      |
| Schuhmacher, Forbici ombelicale .....                             | 90       | Singley-Tuttle, Pinza per dissezione con denti .....       | 146      |
| Schuknecht, Coltello falcato come sinechia .....                  | 659      | Sistema braccio Martin, Martin .....                       | 322      |
| Schumacher, Pinza per biopsia .....                               | 632      | Sistema Divaricatore, Martin-Rochard .....                 | 323      |
| Schumacher, Punta, sola .....                                     | 632      | Skene, Pinza per il collo dell'utero .....                 | 620      |
| Schweden-Modell, Pinza per dissezione .....                       | 128      | Smith-Petersen, Osteotomo .....                            | 469      |
| Scodella rotonda .....  | 758      | Somer, Pinza per afferare l'utero .....                    | 625      |
| Scodella rotonda .....  | 758      | Sonda a bottone .....                                      | 350      |
| Scodella rotonda .....  | 757      | Sonda a bottone, Stacke .....                              | 350      |
| Scodella rotonda .....  | 758      | Sonda a foglia di mirto .....                              | 350      |
| Scollatendini .....   | 508      | Sonda auricolare, Hartmann .....                           | 670      |
| Scoville-Haverfield, Divaricatore per<br>laminectomia .....       | 320      | Sonda cannellata .....                                     | 351      |
| Scoville, Curetta tagliente .....                                 | 484      | Sonda cannellata, Doyen .....                              | 351      |
| Scoville, Divaricatore per laminectomia .....                     | 320      | Sonda cannellata, Nelaton .....                            | 351      |
| Scoville, Valva .....   | 321      | Sonda conduttrice per tendini, Bunnell .....               | 508      |
| Scoville, Valva .....   | 321      | Sonda conduttrice, Brunner .....                           | 435      |
| Scudder, Pinza intestinale .....                                  | 575      | Sonda conduttrice, König .....                             | 437      |
| Sebileau, Elevatore .....   | 501      | Sonda conduttrice, Mod. Martin .....                       | 436      |
| Secchio per rifiuti .....   | 768      | Sonda conduttrice, Payr .....                              | 438      |
| Sedillot, Periototomo .....                                       | 490      | Sonda conduttrice, Schmieden .....                         | 436      |
| Sega nasale, Joseph .....   | 709      | Sonda conduttrice, Schmieden-Payr .....                    | 436      |
| Sega oscillata per gesso .....                                    | 450      | Sonda metallica, per donne .....                           | 595      |
| Segond, Bisturi per fibromi .....                                 | 624      | Sonda per gozzo, Kocher .....                              | 550      |
| Seiffert, Pinza intercambiabile per<br>bronco-esofagoscopia ..... | 732      | Sonde, Bowman .....  | 645      |
| Sellheim, Leva ostetrica .....                                    | 640      | Sordina, Rydel-Seiffert .....                              | 669      |
| Semb, Periototomo .....   | 496      | Spatola addominale .....                                   | 348      |
| Semb, Pinza-sgorbia .....   | 526      | Spatola addominale, Haberer .....                          | 348      |
| Semb, Tenaglia per ossa .....                                     | 515      | Spatola addominale, Kader .....                            | 275      |
| Semken, Pinza per dissezione .....                                | 129      | Spatola addominale, Kümmel .....                           | 275      |
| Semken, Pinza per dissezione con denti .....                      | 131, 140 | Spatola addominale, Martin .....                           | 348      |
| Semmm, Specolo vaginale .....                                     | 601      | Spatola per laringoscopia (luce fredda),<br>Foregger ..... | 397      |
| Senn-Green, Divaricatore .....                                    | 231      | Spatola per laringoscopia (luce fredda),<br>McIntosh ..... | 394-395  |
| Senn-Miller, Divaricatore .....                                   | 231      | Spatola per laringoscopia (luce fredda),<br>Miller .....   | 398-399  |
|   |          | Spatola per laringoscopia, Foregger .....                  | 392-393  |
|   |          | Spatola per laringoscopia, Guedel-Negus .....              | 390      |
|   |          | Spatola per laringoscopia, McIntosh .....                  | 391      |
|   |          | Spatola per laringoscopia, Miller .....                    | 389      |
|   |          | Spazzola per pulire .....                                  | 767      |
|   |          | Spazzola per pulire .....                                  | 767      |
|   |          | Spazzola per pulire .....                                  | 767      |
|   |          | Spazzola per pulire .....                                  | 767      |
|   |          | Spazzola per pulire .....                                  | 764-767  |
|   |          | Spazzola per unghie, Martin-Aseptic .....                  | 742      |
|   |          | Specchi laringei .....                                     | 734      |
|   |          | Specchi laringei, Killian .....                            | 735      |
|   |          | Specolo auricolare, Farrior .....                          | 665      |
|   |          | Specolo auricolare, Hartmann .....                         | 664      |
|   |          | Specolo auricolare, Hartmann .....                         | 664      |
|   |          | Specolo auricolare, set, Toynbee .....                     | 664      |
|   |          | Specolo auricolare, Toynbee .....                          | 664      |
|   |          | Specolo nasale, Cottle .....                               | 682-683  |
|   |          | Specolo nasale, Goldsmith (Thudichum) .....                | 680      |
|   |          | Specolo nasale, Hartmann-Halle .....                       | 680      |
|   |          | Specolo nasale, Killian .....                              | 681      |
|   |          | Specolo nasale, Martin .....                               | 681      |
|   |          | Specolo nasale, Mod. Wien .....                            | 682      |
|   |          | Specolo nasale, Tieck-Halle .....                          | 681      |
|   |          | Specolo rettale, Czerny .....                              | 579      |
|   |          | Specolo rettale, Pratt .....                               | 579      |
|   |          | Specolo rettale, Jackson .....                             | 579      |
|   |          | Specolo vaginale, Auvard .....                             | 611      |
|   |          | Specolo vaginale, Breisky .....                            | 612      |
|   |          | Specolo vaginale, Collin .....                             | 600      |
|   |          | Specolo vaginale, Cusco .....                              | 600      |
|   |          | Specolo vaginale, Doyen .....                              | 612      |
|   |          | Specolo vaginale, Doyen .....                              | 608      |
|   |          | Specolo vaginale, Grave .....                              | 601      |
|   |          | Specolo vaginale, Guttman .....                            | 601      |
|   |          | Specolo vaginale, Jackson .....                            | 602      |
|   |          | Specolo vaginale, Kallmorgen .....                         | 607      |
|   |          | Specolo vaginale, Kristeller .....                         | 603-606  |
|   |          | Specolo vaginale, Pederson .....                           | 601      |
|   |          | Specolo vaginale, Scherbak .....                           | 610      |
|   |          | Specolo vaginale, Semm .....                               | 601      |
|   |          | Specolo vaginale, Sims .....                               | 602      |
|   |          | Specolo vaginale, Weissbarth .....                         | 612      |
|   |          | Spencer-Wells, Pinza emostatica .....                      | 167      |
|   |          | Spencer, Forbici per legature .....                        | 108      |
|   |          | Spratt, Curetta tagliente .....                            | 483      |
|   |          | St. Marks, Divaricatore pelvico .....                      | 274      |
|   |          | St. Marks, marTract .....                                  | 343      |
|   |          | Stacke, Sonda a bottone .....                              | 350      |
|   |          | Steinmann, Pinza per afferare tendini .....                | 509      |
|   |          | Stellbrink, Pinza-sgorbia .....                            | 522      |
|   |          | Stevens, Forbici per iridectomia .....                     | 101-102  |
|   |          | Stieglitz, Pinza per scheggie .....                        | 156      |
|   |          | Stille-Barraya, Pinza per dissezione con denti .....       | 145      |
|   |          | Stille-Liston, Cesioia per ossa .....                      | 532-533  |
|   |          | Stille-Luer, Pinza-sgorbia .....                           | 529      |
|   |          | Stille-Martin, Forbici per gesso .....                     | 445      |
|   |          | Stille-Martin, Lama di ricambio .....                      | 445      |
|   |          | Stille-Ruskin, Pinza-sgorbia .....                         | 527      |
|   |          | Stille, Osteotomo .....                                    | 460-461  |
|   |          | Stille, Pinza per dissezione con denti .....               | 139      |
|   |          | Stille, Pinza-sgorbia .....                                | 526      |
|   |          | Stille, Scalpello .....                                    | 460      |
|   |          | Stille, Sgorbia .....                                      | 461      |
|   |          | Stockmann, Serrapene .....                                 | 598      |
|   |          | Strandell-Stille, Divaricatore .....                       | 234      |
|   |          | Stratte, Portaghi .....                                    | 413, 426 |
|   |          | Strauss, coppia di tubi flessibili singoli .....           | 598      |
|   |          | Strauss, Serrapene .....                                   | 598      |
|   |          | Stripper anello, Vollmar .....                             | 354      |
|   |          | Strully, Forbici per neurchirurgia .....                   | 77       |
|   |          | Strumenti per inserimento catetere, Dittel .....           | 388      |
|   |          | Strumento per circoncisione .....                          | 596      |
|   |          | Strumento per circoncisione, Mogen .....                   | 596      |
|   |          | Strumento tira tendini .....                               | 508      |
|   |          | Strümpel, Pinza per polipi auricolari .....                | 673      |
|   |          | Struycken, Pinza tagliente per il naso .....               | 691      |
|   |          | Stuoa in silicone .....                                    | 753      |
|   |          | Supporto per divaricatore, Martin-Rochard .....            | 323      |
|   |          | Supporto per specoli auricolari .....                      | 665      |
|   |          |  |          |
|   |          | <b>T</b>   |          |
|   |          | Tabb, Bisturi per mucosa .....                             | 659      |
|   |          | Takahashi, Pinza etmoidale .....                           | 688      |
|   |          | Tamponatori, Luniatshchek .....                            | 728      |
|   |          | Taylor, Divaricatore spinale .....                         | 507      |
|   |          | Taylor, Pinza per dissezione .....                         | 129      |
|   |          | Taylor, Pinza per dissezione con denti .....               | 141      |
|   |          | Teale, Pinza per il collo dell'utero .....                 | 620      |
|   |          | Telaio, solo, Kirschner .....                              | 317-319  |
|   |          | Tenaglia per ossa .....                                    | 514      |
|   |          | Tenaglia per ossa .....                                    | 511, 518 |

|  |              |
|--|--------------|
| Tenaglia per ossa.....   | 512          |
| Tenaglia per ossa, Farabeuf.....   | 516          |
| Tenaglia per ossa, Ferguson.....   | 513          |
| Tenaglia per ossa, Frosch.....   | 513          |
| Tenaglia per ossa, Kern.....   | 515          |
| Tenaglia per ossa, Lane.....   | 519          |
| Tenaglia per ossa, Langenbeck.....   | 513          |
| Tenaglia per ossa, Lewin.....  | 512          |
| Tenaglia per ossa, Semb.....   | 515          |
| Tenaglia per ossa, Ulrich.....   | 517          |
| Tenaglia per ossa, Verbrugge.....  | 520-521      |
| Thoms-Allis, Pinza per afferrare intestino<br>e tessuti.....               | 557          |
| Thoms-Gaylor, Pinza per biopsia.....                                       | 629          |
| Thorek, Forbici per dissezione.....  | 50           |
| Tieck-Halle, Specolo nasale.....   | 681          |
| Tiramioni, Doyen.....  | 624          |
| Toennis-Adson, Forbici fine per dissezione.....                            | 78, 113      |
| Toennis, Portaghi.....   | 429          |
| Tohoku, Pinza fissatili.....   | 212          |
| Torchio per cartilagine, Cottle.....                                       | 710          |
| Toynbee, Specolo auricolare.....   | 664          |
| Travers, Divaricatore automatico.....                                      | 283          |
| Tröltsch (Wilde), Pinza auricolare.....                                    | 671          |
| Tröltsch, Pinza per medicature.....  | 686          |
| Tronchesino per pelle.....   | 745          |
| Tronchesino per pelle.....   | 745          |
| Tronchesino per unghie.....  | 745          |
| Tronchesino per unghie.....  | 744          |
| Trousseau, Dilatatore per tracheotomia.....                                | 548          |
| Troutman-Chris, Pinza per afferrare<br>e rompere le lamette da rasoio..... | 4            |
| Tubo allunghi, Brünings.....   | 632          |
| Tubo di aspirazione, Baby-Poole.....                                       | 373          |
| Tubo di aspirazione, Baby-Yankauer.....                                    | 371          |
| Tubo di aspirazione, Baron-Schuknecht.....                                 | 369          |
| Tubo di aspirazione, Byrd.....   | 378          |
| Tubo di aspirazione, Cogswell.....   | 378          |
| Tubo di aspirazione, Cooley.....   | 375          |
| Tubo di aspirazione, De Bakey-Adson.....                                   | 371          |
| Tubo di aspirazione, House.....  | 374          |
| Tubo di aspirazione, Jamieson.....   | 377          |
| Tubo di aspirazione, Luer.....   | 369          |
| Tubo di aspirazione, Nuboer.....   | 377          |
| Tubo di aspirazione, Poole.....  | 373          |
| Tubo di aspirazione, Yankauer.....   | 371-372      |
| Tubo di aspirazione, Yankauer.....   | 372          |
| Tubo di aspirazione, Yasargil.....   | 370          |
| Tubo laringeo, Brünings.....   | 732          |
| Tuffier, Pinza emostatica.....   | 168          |
| Tuohy, Cannula per puntura lumbale.....                                    | 382          |
| Tyding, Serranodi per tonsille.....  | 730          |
| <b>U</b>   |              |
| Ulrich, Pinza per tamponi.....   | 218          |
| Ulrich, Tenaglia per ossa.....   | 517          |
| Uncino auricolare, Day.....  | 678          |
| Uncino auricolare, Hartmann.....   | 677          |
| Uncino auricolare, Lucae.....  | 677          |
| Uncino auricolare, Wagener.....  | 678          |
| Uncino di sondaggio, Shea.....   | 662          |
| Uncino nasale, Cottle.....   | 715          |
| Uncino per fistole, Emmett.....  | 626          |
| Uncino per fistole, Simon.....   | 626          |
| Uncino per le pinne nasali, Converse.....                                  | 716          |
| Uncino per le pinne nasali, Cottle.....                                    | 717          |
| Uncino per le pinne nasali, Cottle-Neivert.....                            | 717          |
| Uncino per le pinne nasali, Fomon.....                                     | 715-716      |
| Uncino per le pinne nasali, Kilner.....                                    | 716          |
| Uncino per le pinne nasali, Lange.....                                     | 715          |
| Uncino per le pinne nasali, Neivert.....                                   | 717          |
| Uncino per mucosa, Freer.....  | 716          |
| Uncino per mucosa, Joseph.....   | 715-716      |
| Uncino per palato, Salyer.....   | 726          |
| Uncino tracheale, Itersen.....   | 549          |
| Uncino tracheale, Jackson.....   | 549          |
| Uncino tracheale, Luer.....  | 549          |
| Uncino tracheale, Rose.....  | 549          |
| Universal, Forbici per bendaggi.....                                       | 444          |
| Universal, Forbici per tagliare fili metallico.....                        | 109          |
| Uro-Tangential, Pinza tangenziali.....                                     | 199          |
| <b>V</b>   |              |
| Valleix, Isterometro.....  | 618          |
| Valva centrale, Alan-Parks.....  | 580          |
| Valva centrale, Balfour.....   | 313          |
| Valva centrale, Balfour-Standard.....                                      | 312, 314-315 |
| Valva centrale, Collin.....  | 305-306      |
| Valva centrale, Gosset.....  | 310          |

|  |               |
|--|---------------|
| Valva centrale, Henley.....                            | 293           |
| Valva centrale, Low-Profile.....                       | 302           |
| Valva centrale, Millin.....                            | 593           |
| Valva centrale, O'Sullivan-O'Connor.....               | 316           |
| Valva centrale, Ricard.....                            | 307           |
| Valva di filo, Balfour, Mod. USA.....                  | 315           |
| Valva laterale.....                                    | 304-309       |
| Valva laterale, Alan-Parks.....                        | 580           |
| Valva laterale, Millin.....                            | 593           |
| Valva vaginale, Kallmorgen.....                        | 607           |
| Valva vaginale, Kristeller.....                        | 603-606       |
| Valva vaginale, sola, Scherbak.....                    | 609           |
| Valva, Cloward.....                                    | 296-297       |
| Valva, Kirschner.....                                  | 317-319       |
| Valva, Scoville.....                                   | 321           |
| Valva, Scoville.....                                   | 321           |
| Valvola di aspirazione, Cerullo.....                   | 370           |
| Van Buren, Candeletta dilatatrice.....                 | 594           |
| Van Doren, Pinza per biopsia.....                      | 630           |
| Varady, Flebo-dissettore.....                          | 352           |
| Varady, Flebo-estrattore.....                          | 352           |
| Varady, Micro-dissettore.....                          | 352           |
| Varady, Micro-estrattore per flebiti.....              | 352           |
| Varady, Mini-estrattore per flebiti.....               | 352           |
| Veidenheimer, Pinza per anastomosi rettili.....        | 577           |
| Verbrugge, Tenaglia per ossa.....                      | 520-521       |
| Vetro di sostituzione.....                             | 743           |
| Virchow, Coltelli.....                                 | 3             |
| Vite.....  | 508           |
| Vite a testa zigrinata, Rydel-Seiffert.....            | 669           |
| Vite di ricambio.....                                  | 462           |
| Volkman, Curetta doppia.....                           | 486           |
| Volkman, Curetta tagliente.....                        | 481-482       |
| Volkman, Divaricatore.....                             | 236-238       |
| Volkman, marTract.....                                 | 344           |
| Vollmar, Stripper anello.....                          | 354           |
| Wachenfeldt, Pinza per applicare le graffe.....        | 439           |
| Wagener, Uncino auricolare.....                        | 678           |
| Wagner, Forbici per chirurgia.....                     | 92            |
| Waldmann, Forbici per episiotomia.....                 | 89            |
| Walter, Osteotomo.....                                 | 707           |
| Walter, Sgorbia.....                                   | 707           |
| Wangensteen, Pinza per dissezione.....                 | 134           |
| Wangensteen, Portaghi.....                             | 413, 424      |
| Wassmund, Divaricatore.....                            | 241           |
| Watson-Williams, Pinza etmoidale.....                  | 689           |
| Waugh, Pinza per dissezione.....                       | 128           |
| Waugh, Pinza per dissezione con denti.....             | 140           |
| Weber-Loch, Ansa auricolare.....                       | 677           |
| Webster, Portaghi.....                                 | 409, 415, 419 |
| Weil-Blakesley, Pinza etmoidale.....                   | 690           |
| Weil-Blakesley, Pinza tagliente per il naso.....       | 690           |
| Weil, Pinza tagliente per il naso.....                 | 689           |
| Weissbarth, Crivello per specola vaginale.....         | 612           |
| Weissbarth, Specolo vaginale.....                      | 612           |
| Weitlaner-Baby, Divaricatore automatico.....           | 292           |
| Weitlaner-Wullstein, Divaricatore automatico.....      | 289           |
| Weitlaner, Divaricatore automatico.....                | 284, 287-288  |
| Wertheim-Cullen, Pinza vaginale.....                   | 205           |
| Wertheim, Forbici per ginecologia.....                 | 36            |
| Wertheim, Pinza per isterectomia.....                  | 208           |
| Westcott, Forbici per strabismo.....                   | 103           |
| Westmacott, Pinza per tamponamenti nasali.....         | 686           |
| White, Pinza per tonsille.....                         | 729           |
| Wikstroem, Pinza per preparazione e legature.....      | 196           |
| Williams, Divaricatore automatico.....                 | 291           |
| Williams, Pinza per afferrare intestino e tessuti..... | 558           |
| Williger, Curetta doppia.....                          | 487           |
| Williger, Elevatore.....                               | 501           |
| Williger, Martello.....                                | 475, 477      |
| Williger, Periostotomo.....                            | 494           |
| Winter, Pinza per placenta e per ovaie.....            | 640           |
| Wolff, Pinza per rompere gesso.....                    | 449           |
| Wrigley, Forcipe obstetrica.....                       | 638           |
| Wullstein, Cannula d'aspirazione.....                  | 368           |
| Wullstein, Coltello falcato come sinechia.....         | 659           |
| Wullstein, Micro Forbici auricolare.....               | 655           |
| Wullstein, Punta per aspirazione.....                  | 368           |
| <b>Y</b>   |               |
| Yankauer, Manico.....                                  | 372           |
| Yankauer, Oliva.....                                   | 372           |
| Yankauer, Punta per aspirazione.....                   | 372           |
| Yankauer, Tubo di aspirazione.....                     | 371-372       |
| Yankauer, Tubo di aspirazione.....                     | 372           |
| Yasargil, Tubo di aspirazione.....                     | 370           |
| Young, Divaricatore prostatico.....                    | 589           |

**Z**

|  |     |
|--|-----|
| Zaufal-Jansen, Pinza-sgorbia.....              | 525 |
| Zaufal, Leva per corpi estranei.....           | 677 |
| Zenker, Divaricatore.....                      | 250 |
| Zenker, Pinza per preparazione e legature..... | 194 |
| Zielke, Sgorbia.....                           | 459 |
| Zoccolo, Lucae.....                            | 668 |
| Zoellner, Cannula d'aspirazione.....           | 368 |
| Zoellner, Punta per aspirazione.....           | 368 |



## KLS Martin Group

### **KLS Martin Australia Pty Ltd.**

Sydney · Australia  
Tel. +61 2 9439 5316  
australia@klsmartin.com

### **KLS Martin do Brasil Ltda.**

São Paulo · Brazil  
Tel. +55 11 3554 2299  
brazil@klsmartin.com

### **KLS Martin Medical (Shanghai) International Trading Co. Ltd.**

Shanghai · China  
Tel. +86 21 5820 6251  
china@klsmartin.com

### **KLS Martin India Pvt Ltd.**

Chennai · India  
Tel. +91 44 66 442 300  
india@klsmartin.com

### **Martin Italia S.r.l.**

Milan · Italy  
Tel. +39 039 605 67 31  
italia@klsmartin.com

### **Nippon Martin K.K.**

Tokyo · Japan  
Tel. +81 3 3814 1431  
nippon@klsmartin.com

### **KLS Martin SE Asia Sdn. Bhd.**

Penang · Malaysia  
Tel. +604 505 7838  
malaysia@klsmartin.com

### **KLS Martin de México S.A. de C.V.**

Mexico City · Mexico  
Tel. +52 55 7572 0944  
mexico@klsmartin.com

### **Martin Nederland/Marned B.V.**

Huizen · The Netherlands  
Tel. +31 35 523 45 38  
nederland@klsmartin.com

### **Gebrüder Martin GmbH & Co. KG**

Moscow · Russia  
Tel. +7 499 792-76-19  
russia@klsmartin.com

### **KLS Martin Taiwan Ltd.**

Taipei 106 · Taiwan  
Tel. +886 2 2325 3169  
taiwan@klsmartin.com

### **Gebrüder Martin GmbH & Co. KG**

Dubai · United Arab Emirates  
Tel. +971 4 454 16 55  
middleeast@klsmartin.com

### **KLS Martin UK Ltd.**

Reading · United Kingdom  
Tel. +44 1189 000 570  
uk@klsmartin.com

### **KLS Martin LP**

Jacksonville · Florida, USA  
Tel. +1 904 641 77 46  
usa@klsmartin.com

### **Gebrüder Martin GmbH & Co. KG**

#### **A company of the KLS Martin Group**

KLS Martin Platz 1 · 78532 Tuttlingen · Germany  
P.O. Box 60 · 78501 Tuttlingen · Germany  
Tel. +49 7461 706-0 · Fax +49 7461 706-193  
info@klsmartin.com · www.klsmartin.com

